



OcNOS®

**Open Compute Network Operating System
for Data Centers**

System Management

Version 6.6.0

February 2025

©2025 IP Infusion Inc. All Rights Reserved.

This documentation is subject to change without notice. The software described in this document and this documentation are furnished under a license agreement or nondisclosure agreement. The software and documentation may be used or copied only in accordance with the terms of the applicable agreement. No part of this publication may be reproduced, stored in a retrieval system, or transmitted in any form or any means electronic or mechanical, including photocopying and recording for any purpose other than the purchaser's internal use without the written permission of IP Infusion Inc.

IP Infusion Inc.

3979 Freedom Circle, Suite 900

Santa Clara, CA 95054

+1 408-400-1900

<http://www.ipinfusion.com/>

For support, questions, or comments via E-mail, contact:

support@ipinfusion.com

Trademarks:

IP Infusion and OcNOS are trademarks or registered trademarks of IP Infusion. All other trademarks, service marks, registered trademarks, or registered service marks are the property of their respective owners.

Use of certain software included in this equipment is subject to the IP Infusion, Inc. End User License Agreement at <http://www.ipinfusion.com/license>. By using the equipment, you accept the terms of the End User License Agreement.

| CONTENTS

Contents	4
Preface	128
About this Guide	128
IP Maestro Support	128
Audience	128
Conventions	128
Chapter Organization	128
Related Documentation	129
Feature Availability	129
Migration Guide	129
Support	129
Comments	129
Command Line Interface	130
Command Line Interface Help	130
Command Completion	131
Command Abbreviations	131
Command Line Errors	131
Command Negation	132
Syntax Conventions	132
Variable Placeholders	133
Command Description Format	134
Keyboard Operations	134
Show Command Modifiers	135
Begin Modifier	135
Include Modifier	136
Exclude Modifier	136
Redirect Modifier	137
Last Modifier	137
String Parameters	137
Command Modes	137
Command Mode Tree	139
Transaction-based Command-line Interface	139
Authentication Management Configuration	141
AAA Configuration for Console Connection	142
Overview	142
Feature Characteristics	142
Configuration	142
Validation	143
Glossary	145
Restricted Access to Privilege Mode based on User Role	146
Overview	146

Feature Characteristics	146
Prerequisites	146
Configuration	146
CLI Commands	148
Glossary	148
RADIUS Client Configuration	149
Overview	149
Limitation	149
RADIUS Authorization Configuration	149
Benefits	149
Prerequisites	150
Configuration	150
Topology	150
IPv4 Address	150
IPv6 Address	152
Implementation Examples	152
RADIUS Server Authentication Configuration	153
IPv4 Address	153
IPv6 Address	159
RADIUS Server Accounting	160
User	160
Sample Radius Clients.conf File	161
Sample Radius Users Configuration File	161
Fall Back Option for RADIUS Authentication	162
Overview	162
Benefits	162
Configuration	162
TACACS Client Configuration	164
Overview	164
TACACS Server Authentication	164
IPv4 Address Configuration	164
TACACS Server Accounting	173
Authenticating Device	173
Validation Commands	173
TACACS Server Authorization	175
Example	175
Sample TACACS+ Configuration File	175
Role-Based Access Control	177
Overview	177
Feature Characteristics	177
Benefits	178
Prerequisites	178
RBAC Configuration	178
Example 1	178
Example 2	179
Implementation Examples	180
RBAC Commands	180

add policy	181
default	182
deny	183
feature dynamic-rbac	184
permit	185
policy	186
role	187
show rbac-policy	188
show rbac-role	189
Troubleshooting	190
Abbreviations	190
Glossary	190
Authentication Management Command Reference	191
Authentication, Authorization and Accounting	193
aaa authentication login	195
Command Syntax	195
Parameters	195
Default	195
Command Mode	195
Applicability	195
Examples	195
aaa accounting default	196
Command Syntax	196
Parameters	196
Default	196
Command Mode	196
Applicability	196
Examples	196
aaa authentication login default	197
Command Syntax	197
Parameters	197
Default	197
Command Mode	197
Applicability	197
Examples	198
aaa authorization default	199
Command Syntax	199
Parameters	199
Default	199
Command Mode	199
Applicability	199
Examples	199
aaa authentication login console fallback error	200
Command Syntax	200
Parameters	200
Default	200

Command Mode	200
Applicability	200
Examples	200
aaa authentication login default fallback error	201
Command Syntax	201
Parameters	201
Default	201
Command Mode	201
Applicability	201
Examples	201
aaa group server	202
Command Syntax	202
Parameters	202
Default	202
Command Mode	202
Applicability	202
Examples	202
aaa local authentication attempts max-fail	203
Command Syntax	203
Parameters	203
Default	203
Command Mode	203
Applicability	203
Examples	203
aaa local authentication unlock-timeout	204
Command Syntax	204
Parameters	204
Default	204
Command Mode	204
Applicability	204
Examples	204
debug aaa	205
Command Syntax	205
Parameters	205
Command Mode	205
Applicability	205
Examples	205
disable default auto-enable	205
Command Syntax	205
Parameters	205
Command Mode	205
Applicability	205
Examples	206
server	207
Command Syntax	207
Parameters	207
Default	207

Command Modes	207
Applicability	207
Examples	207
show aaa authentication	208
Command Syntax	208
Parameters	208
Command Modes	208
Applicability	208
Examples	208
show aaa authentication login	209
Command Syntax	209
Parameters	209
Command Modes	209
Applicability	209
Examples	209
show aaa authorization	210
Command Syntax	210
Parameters	210
Command Modes	210
Applicability	210
Examples	210
show aaa groups	211
Command Syntax	211
Parameters	211
Command Modes	211
Applicability	211
Examples	211
show aaa accounting	212
Command Syntax	212
Parameters	212
Command Modes	212
Applicability	212
Examples	212
show running-config aaa	213
Command Syntax	213
Parameters	213
Command Modes	213
Applicability	213
Examples	213
TACACS+ Commands	214
add policy	215
Command Syntax	215
Parameters	215
Default	215
Command Mode	215
Applicability	215
Examples	215

clear tacacs-server counters	216
Syntax	216
Parameters	216
Default	216
Command Mode	216
Applicability	216
Example	216
debug tacacs+	217
Command Syntax	217
Parameters	217
Default	217
Command Mode	217
Applicability	217
Examples	217
default	218
Command Syntax	218
Parameters	218
Default	218
Command Mode	218
Applicability	218
Examples	218
deny	219
Command Syntax	219
Parameters	219
Default	219
Command Mode	219
Applicability	219
Examples	219
feature dynamic-rbac	220
Command Syntax	220
Parameters	220
Default	220
Command Mode	220
Applicability	220
Examples	220
feature tacacs+	221
Command Syntax	221
Parameters	221
Default	221
Command Mode	221
Applicability	221
Examples	221
show debug tacacs+	222
Command Syntax	222
Parameters	222
Command Mode	222
Applicability	222

Examples	222
show rbac-policy	223
Command Syntax	223
Parameters	223
Default	223
Command Mode	223
Applicability	223
Examples	223
show rbac-role	224
Command Syntax	224
Parameters	224
Default	224
Command Mode	224
Applicability	224
Examples	224
show running-config tacacs+	225
Command Syntax	225
Parameters	225
Command Mode	225
Applicability	225
Examples	225
show tacacs-server	226
Command Syntax	226
Parameters	226
Command Mode	226
Applicability	226
Examples	226
tacacs-server login host	228
Command Syntax	228
Parameters	228
Default	229
Command Mode	229
Applicability	229
Examples	229
tacacs-server login key	230
Command Syntax	230
Parameters	230
Default	230
Command Mode	230
Applicability	230
Examples	230
tacacs-server login timeout	231
Command Syntax	231
Parameters	231
Default	231
Command Mode	231
Applicability	231

Examples	231
RADIUS Commands	232
clear radius-server	232
Command Syntax	232
Parameters	232
Default	233
Command Mode	233
Applicability	233
Example	233
debug radius	233
Command Syntax	233
Parameters	233
Command Mode	233
Applicability	233
Examples	233
radius-server login host	234
Command Syntax	234
Parameters	234
Default	234
Command Mode	235
Applicability	235
Examples	235
radius-server login host acct-port	235
Command Syntax	235
Parameters	235
Default	236
Command Mode	236
Applicability	236
Examples	236
radius-server login host auth-port	236
Command Syntax	236
Parameters	236
Default	237
Command Mode	237
Applicability	237
Examples	237
radius-server login host key	237
Command Syntax	238
Parameters	238
Default	239
Command Mode	239
Applicability	239
Examples	239
radius-server login key	239
Command Syntax	239
Parameters	239
Default	240

Command Mode	240
Applicability	240
Examples	240
radius-server login timeout	240
Command Syntax	240
Parameters	240
Default	241
Command Mode	241
Applicability	241
Examples	241
show debug radius	241
Command Syntax	241
Parameters	241
Command Mode	241
Applicability	242
Examples	242
show radius-server	242
Command Syntax	242
Parameters	242
Command Mode	242
Applicability	242
Examples	242
show running-config radius	243
Command Syntax	243
Parameters	243
Command Mode	243
Applicability	243
Examples	243
Remote Device Connect Configuration	244
Telnet Configuration	245
Overview	245
In-band Management Over Default VRF	245
Telnet Configuration with IPv4 Address	245
Telnet Configuration with IPv6 Address	246
In-band Management Over User Defined VRF	248
Telnet Configuration with IPv4 Address	248
Telnet Configuration with IPv6 Address	249
SSH Client Server Configuration	251
Overview	251
In-band Management over Default VRF	251
SSH Configuration	251
IPv4 Address Configuration	251
IPv6 Address Configuration	253
SSH Encryption Cipher	254
Overview	254
Prerequisites	256

Configuration	256
Validation	258
SSH Key-Based Authentication	258
Topology	259
Public Key Authentication Method	259
Validation	260
SSH Key-based Client Session	260
Max Session and Session Limit Configuration	263
Overview	263
Topology	263
Configuration of Telnet Session Limit Lesser than Max-Session	263
Validation	264
Configuration of SSH Server Session Limit Lesser than Max-Session	264
Topology	264
Configuration of Telnet Session Limit Greater than Max-Session	265
Topology	265
Configuration of SSH Session Limit Greater than Max-Session	266
Topology	266
Remote Device Connect Command Reference	268
Telnet	269
debug telnet server	270
Command Syntax	270
Parameters	270
Default	270
Command Mode	270
Applicability	270
Examples	270
feature telnet	271
Command Syntax	271
Parameters	271
Default	271
Command Mode	271
Applicability	271
Examples	271
show debug telnet-server	272
Command Syntax	272
Parameters	272
Command Mode	272
Applicability	272
Examples	272
show running-config telnet server	273
Command Syntax	273
Parameters	273
Command Mode	273
Applicability	273
Examples	273

show telnet-server	274
Command Syntax	274
Parameters	274
Command Mode	274
Applicability	274
Examples	274
telnet	275
Command Syntax	275
Parameters	275
Default	275
Command Mode	275
Applicability	275
Examples	275
telnet6	276
Command Syntax	276
Parameters	276
Default	276
Command Mode	276
Applicability	276
Examples	276
telnet server port	277
Command Syntax	277
Parameters	277
Default	277
Command Mode	277
Applicability	277
Examples	277
telnet server session-limit	278
Command Syntax	278
Parameters	278
Default	278
Command Mode	278
Applicability	278
Examples	278
Secure Shell Commands	279
clear ssh host-key	280
Command syntax	280
Parameters	280
Default	280
Command Mode	280
Applicability	280
Examples	280
clear ssh hosts	281
Command Syntax	281
Parameters	281
Command Mode	281
Applicability	281

Examples	281
clear ssh keypair	282
Command Syntax	282
Parameters	282
Command Mode	282
Applicability	282
Examples	282
debug ssh server	283
Command Syntax	283
Parameters	283
Default	283
Command Mode	283
Applicability	283
Examples	283
feature ssh	284
Command Syntax	284
Parameters	284
Default	284
Command Mode	284
Applicability	284
Examples	284
show debug ssh-server	285
Command Syntax	285
Parameters	285
Command Mode	285
Applicability	285
Examples	285
show running-config ssh server	286
Command Syntax	286
Parameters	286
Command Mode	286
Applicability	286
Examples	286
show ssh host-key	287
Command syntax	287
Parameters	287
Default	287
Command Mode	287
Applicability	287
Examples	287
show ssh server	289
Command Syntax	289
Parameters	289
Command Mode	289
Applicability	289
Examples	289
show username	290

Command Syntax	290
Parameters	290
Command Mode	290
Applicability	290
Examples	290
ssh	291
Command Syntax	291
Parameters	291
Default	291
Command Mode	292
Applicability	292
Examples	292
ssh6	293
Command Syntax	293
Parameters	293
Default	293
Command Mode	294
Applicability	294
Examples	294
ssh algorithm encryption	295
Command Syntax	295
Parameters	295
Default	296
Command Mode	296
Applicability	296
Examples	296
ssh keygen host	297
Command syntax	297
Parameters	297
Default	297
Command Mode	297
Applicability	298
Examples	298
ssh login-attempts	299
Command Syntax	299
Parameters	299
Default	299
Command Mode	299
Applicability	299
Examples	299
ssh server algorithm encryption	300
Command Syntax	300
Parameters	300
Default	300
Command Mode	300
Applicability	300
Example	300

ssh server algorithm kex	302
Command Syntax	302
Parameters	302
Default	302
Command Mode	302
Applicability	302
Example	302
ssh server algorithm mac	304
Command Syntax	304
Parameters	304
Default	304
Command Mode	304
Applicability	304
Example	305
show ssh server algorithm	306
Command Syntax	306
Parameters	306
Default	306
Command Mode	306
Applicability	306
Example	306
ssh server default algorithm	307
Command Syntax	307
Parameters	307
Default	307
Command Mode	307
Applicability	307
Example	307
ssh server port	308
Command Syntax	308
Parameters	308
Default	308
Command Mode	308
Applicability	308
Examples	308
ssh server session-limit	309
Command Syntax	309
Parameters	309
Default	309
Command Mode	309
Applicability	309
Examples	309
username sshkey	310
Command Syntax	310
Parameters	310
Default	310
Command Mode	310

Applicability	310
Examples	310
username keypair	311
Command Syntax	311
Parameters	311
Default	311
Command Mode	311
Applicability	311
Examples	311
User Management Configuration	312
User Config AES Encryption	313
Overview	313
Feature Characteristics	313
Benefits	313
Configuration	313
Configuration Snapshot:	313
Validation	315
Implementation Examples	315
global key-encryption	315
Command Syntax	316
Parameters	316
Default	316
Applicability	316
Example	316
show global key-encryption	316
Command Syntax	316
Parameters	316
Default	316
Applicability	316
Example	316
Using the Management Interface	317
Overview	317
Management Port	317
Static IP Configuration	317
Obtaining IP Address via DHCP	318
In-Band Ports	319
Using Ping in Management VRF	319
User Configuration	321
Overview	321
User Configuration	321
Validation	321
Configurable Password Policy	323
Overview	323
Feature Characteristics	323
Benefits	324
Configuration	324

Topology	324
OcNOS Device	324
Validation 1	324
Validation 2	325
Implementation Examples	325
max-password-age	326
Configuration	326
Removing Users with Expired Passwords	327
Glossary	328
New CLI Commands	328
aaa authentication password-policy	329
aaa local authentication password-policy	330
aaa local authentication password expire role	330
aaa local authentication password expire user	331
aaa local authentication password-policy disable-usercheck	332
aaa local authentication password-policy history	333
aaa local authentication password-policy lowercase-count	334
aaa local authentication password-policy maxrepeat	335
aaa local authentication password-policy maxsequence	336
aaa local authentication password-policy min-length	337
aaa local authentication password-policy numeric-count	338
aaa local authentication password-policy special-count	339
aaa local authentication password-policy uppercase-count	340
Stronger User Password Hashes	341
Overview	341
Feature Characteristics	341
Key Considerations	341
Benefits	341
Configuration	341
Topology	341
Configuration Snapshot:	342
Validation	342
Implementation Examples	343
CLI Commands	343
user password encryption default	343
Command Syntax	343
Parameters	343
Default	343
Command Mode	343
Applicability	343
Examples	343
show user password encryption	344
Command Syntax	344
Parameters	344
Default	344
Command Mode	344
Applicability	344

Examples	344
User Management Command Reference	345
User Management	346
clear aaa local user lockout username	347
Command Syntax	347
Parameters	347
Command Mode	347
Applicability	347
Example	347
debug user-mgmt	348
Command Syntax	348
Parameters	348
Default	348
Command Mode	348
Applicability	348
Example	348
show user-account	349
Command Syntax	349
Parameters	349
Command Mode	349
Applicability	349
Example	349
username	350
Command Syntax	350
Parameters	350
Default	351
Command Mode	351
Applicability	351
Example	351
DHCP Configuration	352
DHCP Client Configuration	353
Overview	353
DHCP Client Configuration for IPv4	353
Validation Commands	354
DHCP Client Configuration for IPv6	354
Validation Commands	355
DHCP Server Configuration	357
Overview	357
DHCP Server Configuration for IPv4	357
Topology	357
Configuration	357
DHCP Server Configuration for IPv6	358
Topology	359
Configuration	359
Validation	360
DHCP Server Group	362

Overview	362
Feature Characteristics	363
Benefits	363
Configuration	363
Topology	363
DHCP Server-1 Configuration for IPv4	364
DHCP Server-2 Configuration for IPv4	366
DHCP Relay Agent Configuration for IPv4	367
DHCP Client Configuration for IPv4	369
DHCP Server-1 Configuration for IPv6	370
DHCP Server-2 Configuration for IPv6	371
DHCP Relay Agent Configuration for IPv6	372
DHCP Client Configuration for IPv6	374
New CLI Commands	375
ip dhcp relay server-group	377
ip dhcp relay server-select	378
ipv6 dhcp relay server-group	379
ipv6 dhcp relay server-select	380
server A.B.C.D	381
server X::X::X:X	382
DHCP Relay Agent Configuration	383
Overview	383
DHCP Relay for IPv4	383
DHCP Agent	383
Validation Commands	384
DHCP Relay for IPv6 Configuration	384
DHCP Agent	384
Validation Commands	385
DHCP Relay option 82	385
Topology	386
Physical Interface Configuration	386
Validation	387
Physical Interface Configuration with non-default VRF	388
Validation	389
VLAN Interface Configuration	391
DHCP-Relay with different VRFs	392
DHCP Relay for IPv4 with different VRFs	393
DHCP Relay for IPv6 Configuration with different VRFs	394
DHCP Agent	394
Validation Commands	395
DHCPv6 Prefix Delegation Configuration	396
Overview	396
Feature Characteristics	396
Benefits	396
Configuration	396
Topology	397
Configuring DHCP prefixes	397

Glossary	401
DHCPv6 Relay Prefix Delegation Route Injection Configuration	403
Overview	403
Topology	403
DHCP Relay - Delegating Router (DR)	403
Requesting Router (RR)	404
HOST	404
Linux Host	405
DHCP Server	405
Sample dhcpd6.conf file	405
Validation	405
DHCP Command Reference	408
Dynamic Host Configuration Protocol Client	410
feature dhcp	411
Command Syntax	411
Parameters	411
Default	411
Command Mode	411
Applicability	411
Examples	411
ip address dhcp	412
Command Syntax	412
Parameters	412
Default	412
Command Mode	412
Applicability	412
Examples	412
ip dhcp client request	413
Command Syntax	413
Parameters	413
Default	413
Command Mode	413
Applicability	413
Examples	413
ipv6 address dhcp	414
Command Syntax	414
Parameters	414
Default	414
Command Mode	414
Applicability	414
Examples	414
ipv6 dhcp address-prefix-length	415
Command Syntax	415
Parameters	415
Default	415
Command Mode	415

Applicability	415
Examples	415
ipv6 dhcp client request	416
Command Syntax	416
Parameters	416
Default	416
Command Mode	416
Applicability	417
Examples	417
ipv6 dhcp client	418
Command Syntax	418
Parameters	418
Default	418
Command Mode	418
Applicability	419
Examples	419
show ipv6 dhcp vendor-opts	420
Command Syntax	420
Parameters	420
Command Mode	420
Applicability	420
Examples	420
Dynamic Host Configuration Protocol Relay	421
clear ip dhcp relay option statistics	423
Command Syntax	423
Parameters	423
Command Mode	423
Applicability	423
Examples	423
clear ipv6 dhcp pd-route (vrf NAME)	424
Command Syntax	424
Parameters	424
Default	424
Command Mode	424
Applicability	424
Examples	424
clear ip dhcp relay statistics	425
Command Syntax	425
Parameters	425
Command Mode	425
Applicability	425
Examples	425
ip dhcp relay (configure mode)	426
Command Syntax	426
Parameters	426
Default	426
Command Mode	426

Applicability	426
Examples	426
ip dhcp relay (interface mode)	427
Command Syntax	427
Parameters	427
Default	427
Command Mode	427
Applicability	427
Examples	427
ip dhcp relay (L3VPN)	428
Command Syntax	428
Parameters	428
Default	428
Command Mode	428
Applicability	428
Examples	428
ip dhcp relay address	429
Command Syntax	429
Parameters	429
Default	429
Command Mode	429
Applicability	429
Examples	429
ip dhcp relay address global	430
Command Syntax	430
Parameters	430
Default	430
Command Mode	430
Applicability	430
Examples	430
ip dhcp relay information option	431
Command Syntax	431
Parameters	431
Default	431
Command Mode	431
Applicability	431
Examples	431
ip dhcp relay information option always-on	432
Command Syntax	432
Parameters	432
Default	432
Command Mode	432
Applicability	432
Examples	432
ip dhcp relay information source-ip	433
Command Syntax	433
Parameters	433

Default	433
Command Mode	433
Applicability	433
Example	433
ip dhcp relay server-group	434
Command Syntax	434
Parameters	434
Command Mode	434
Applicability	434
Examples	434
ip-dhcp-relay-server-select	435
Command Syntax	435
Parameters	435
Command Mode	435
Applicability	435
Examples	435
ipv6 dhcp relay (configure mode)	436
Command Syntax	436
Parameters	436
Default	436
Command Mode	436
Applicability	436
Examples	436
ipv6 dhcp relay (interface mode)	437
Command Syntax	437
Parameters	437
Default	437
Command Mode	437
Applicability	437
Examples	437
ipv6 dhcp relay (L3VPN)	438
Command Syntax	438
Parameters	438
Default	438
Command Mode	438
Applicability	438
Examples	438
ipv6 dhcp relay address	439
Command Syntax	439
Parameters	439
Default	439
Command Mode	439
Applicability	439
Examples	439
ipv6 dhcp relay address global	440
Command Syntax	440
Parameters	440

Default	440
Command Mode	440
Applicability	440
Examples	440
ipv6 dhcp relay pd-route-injection	441
Command Syntax	441
Parameters	441
Default	441
Command Mode	441
Applicability	441
Examples	441
ipv6 dhcp relay server-group	442
Command Syntax	442
Parameters	442
Command Mode	442
Applicability	442
Examples	442
ipv6 dhcp relay server-select	443
Command Syntax	443
Parameters	443
Command Mode	443
Applicability	443
Examples	443
ipv6 dhcp relay subscriber-id	444
Command Syntax	444
Parameters	444
Default	444
Command Mode	444
Applicability	444
Examples	444
server A.B.C.D	445
Command Syntax	445
Parameters	445
Command Mode	445
Applicability	445
Examples	445
server X::X::X:X	446
Command Syntax	446
Parameters	446
Command Mode	446
Applicability	446
Examples	446
show ip dhcp relay	447
Command Syntax	447
Parameters	447
Command Mode	447
Applicability	447

Examples	447
show ip dhcp relay address	448
Command Syntax	448
Parameters	448
Command Mode	448
Applicability	448
Examples	448
show ip dhcp relay option statistics	449
Command Syntax	449
Parameters	449
Command Mode	449
Applicability	449
Examples	449
show ip dhcp relay statistics	450
Command Syntax	450
Parameters	450
Command Mode	450
Applicability	450
Examples	450
show ipv6 dhcp pd-route	451
Command Syntax	451
Parameters	451
Command Mode	451
Applicability	451
Examples	451
show ipv6 dhcp relay	452
Command Syntax	452
Parameters	452
Command Mode	452
Applicability	452
Examples	452
show ipv6 dhcp relay address	453
Command Syntax	453
Parameters	453
Command Mode	453
Applicability	453
Examples	453
show running-config dhcp	454
Command Syntax	454
Parameters	454
Command Mode	454
Applicability	454
Examples	454
DHCPv6 Prefix Delegation Commands	455
ipv6 address	456
Command Syntax	456
Parameters	456

Default	456
Command Mode	456
Applicability	456
Examples	456
ipv6 address autoconfig	457
Command Syntax	457
Parameters	457
Default	457
Command Mode	457
Applicability	457
Examples	457
ipv6 dhcp client max-delegated-prefixes	458
Command Syntax	458
Parameters	458
Default	458
Command Mode	458
Applicability	458
Example	458
ipv6 dhcp prefix-delegation	459
Command Syntax	459
Parameters	459
Default	459
Command Mode	459
Applicability	459
Examples	459
show ipv6 dhcp interface	460
Command Syntax	460
Parameters	460
Command Mode	460
Applicability	460
Examples	460
DHCP Server Commands	461
address range low-address A.B.C.D	462
Command Syntax	462
Parameters	462
Default	462
Command Mode	462
Applicability	462
Examples	462
address range low-address X:X::X:X	463
Command Syntax	463
Parameters	463
Default	463
Command Mode	463
Applicability	463
Examples	463
boot-file	464

Command Syntax	464
Parameters	464
Default	464
Command Mode	464
Applicability	464
Examples	464
dns-server A.B.C.D	465
Command Syntax	465
Parameters	465
Default	465
Command Mode	465
Applicability	465
Examples	465
dns-server X:X::X:X	466
Command Syntax	466
Parameters	466
Default	466
Command Mode	466
Applicability	466
Examples	466
domain-name	467
Command Syntax	467
Parameters	467
Default	467
Command Mode	467
Applicability	467
Examples	467
host-name	468
Command Syntax	468
Parameters	468
Default	468
Command Mode	468
Applicability	468
Examples	468
ip dhcp server (interface mode)	469
Command Syntax	469
Parameters	469
Default	469
Command Mode	469
Applicability	469
Examples	469
ip dhcp server default-lease-time	470
Command Syntax	470
Parameters	470
Default	470
Command Mode	470
Applicability	470

Examples	470
ip dhcp server max-lease-time	471
Command Syntax	471
Parameters	471
Default	471
Command Mode	471
Applicability	471
Examples	471
ip dhcp server pool	472
Command Syntax	472
Parameters	472
Default	472
Applicability	472
Examples	472
ipv6 dhcp server (interface mode)	473
Command Syntax	473
Parameters	473
Default	473
Command Mode	473
Applicability	473
Examples	473
ipv6 dhcp server pool	474
Command Syntax	474
Parameters	474
Default	474
Command Mode	474
Applicability	474
Examples	474
ipv6 dhcp server preference	475
Command Syntax	475
Parameters	475
Default	475
Command Mode	475
Applicability	475
Examples	475
ipv6 dhcp server rapid-commit	476
Command Syntax	476
Parameters	476
Default	476
Command Mode	476
Applicability	476
Examples	476
log-server	477
Command Syntax	477
Parameters	477
Default	477
Command Mode	477

Applicability	477
Examples	477
network A.B.C.D netmask	478
Command Syntax	478
Parameters	478
Default	478
Command Mode	478
Applicability	478
Examples	478
network X:X::X:X netmask	479
Command Syntax	479
Parameters	479
Default	479
Command Mode	479
Applicability	479
Examples	479
ntp-server A.B.C.D	480
Command Syntax	480
Parameters	480
Default	480
Command Mode	480
Applicability	480
Examples	480
ntp-server X:X::X:X	481
Command Syntax	481
Parameters	481
Default	481
Command Mode	481
Applicability	481
Examples	481
prefix high-range	482
Command Syntax	482
Parameters	482
Default	482
Command Mode	482
Applicability	482
Example	482
routers A.B.C.D	483
Command Syntax	483
Parameters	483
Default	483
Command Mode	483
Applicability	483
Examples	483
temporary address X:X::X:X	484
Command Syntax	484
Parameters	484

Default	484
Command Mode	484
Applicability	484
Examples	484
tftp-server	485
Command Syntax	485
Parameters	485
Default	485
Command Mode	485
Applicability	485
Examples	485
vendor-options	486
Command Syntax	486
Parameters	486
Default	486
Command Mode	486
Applicability	486
Examples	486
DNS Configuration	487
DNS Configuration	488
Overview	488
In-band management over Default VRF	488
Topology	488
VRF Management Configuration-IPv4	488
Validation	489
VRF Management Configuration-IPv6	489
Validation	489
User Defined VRF Configuration-IPv4	489
Validation	490
User Defined Configuration-IPv6	490
Validation	490
DNS Command Reference	491
Domain Name System Commands	492
debug dns client	492
Command Syntax	492
Parameters	492
Default	492
Command Mode	493
Applicability	493
Examples	493
ip domain-list	493
Command Syntax	493
Parameters	493
Default	493
Command Mode	493
Applicability	493

Example	494
ip domain-lookup	494
Command Syntax	494
Parameters	494
Default	494
Command Mode	494
Applicability	494
Example	494
ip domain-name	494
Command Syntax	495
Parameters	495
Default	495
Command Mode	495
Applicability	495
Example	495
ip host	495
Command Syntax	495
Parameters	496
Default	496
Command Mode	496
Applicability	496
Examples	496
ip name-server	496
Command Syntax	496
Parameters	497
Default	497
Command Mode	497
Applicability	497
Examples	497
show hosts	497
Command Syntax	497
Parameters	497
Command Mode	497
Applicability	498
Example	498
show running-config dns	498
Command Syntax	498
Parameters	499
Command Mode	499
Applicability	499
Example	499
NTP Configuration Guide	500
NTP Client Configuration	501
Overview	501
In-band management via Default VRF	501
NTP Modes	501

Client	501
Server	501
Peer	501
Authentication	501
NTP Client Configuration with IPv4 Address	502
Topology	502
NTP Client for User Management	502
NTP Client for User Defined VRF	503
Maxpoll and Minpoll Configuration	503
NTP Authentication	504
NTP Client Configuration with IPv6 Address	505
Topology	506
Configuration of VRF Management	506
Configuration of User Defined VRF	506
Maxpoll and Minpoll Configuration	507
NTP Authentication	508
NTP Server Configuration	510
Topology	510
Configuration	510
NTP Master	510
NTP Client	511
Validation	511
Synchronization of more than one NTP clients with the NTP Master	511
Topology	511
VRF Management Configuration	512
User Defined VRF Configuration	513
Synchronization with Authentication	515
Topology	515
VRF Management Configuration	516
User Defined VRF Configuration	517
Synchronization of NTP Server and NTP Clients with NTP ACL	519
Topology	519
VRF Management Configuration	520
User Defined VRF Configuration	522
Synchronization of NTP Server and NTP Clients with NTP ACL configured as noserve	524
Topology	524
VRF Management Configuration	525
User Defined VRF Configuration	526
Synchronization of NTP Client with Stratum 2 NTP Master	528
Topology	528
Management VRF Configuration	528
User Defined VRF Configuration	530
NTP Command Reference	532
Network Time Protocol	533
clear ntp statistics	533
Command Syntax	534

Parameters	534
Command Mode	534
Applicability	534
Example	534
debug ntp	534
Command Syntax	534
Parameters	534
Command Mode	534
Applicability	534
Examples	535
feature ntp	535
Command Syntax	535
Parameters	535
Default	535
Command Mode	535
Applicability	535
Examples	535
ntp acl	535
Command Syntax	536
Parameters	536
Default	536
Command Mode	537
Applicability	537
Example	537
ntp authenticate	537
Command Syntax	537
Parameters	537
Default	537
Command Mode	537
Applicability	537
Example	537
ntp authentication-key	538
Command Syntax	538
Parameters	538
Default	538
Command Mode	538
Applicability	538
Example	538
ntp enable	538
Command Syntax	538
Parameters	539
Default	539
Command Mode	539
Applicability	539
Example	539
ntp discard	539
Command Syntax	539

Command Syntax	539
Default	539
Command Mode	540
Applicability	540
Example	540
ntp logging	540
Command Syntax	540
Parameters	540
Default	540
Command Mode	540
Applicability	540
Example	540
ntp master	541
Command Syntax	541
Parameters	541
Default	541
Command Mode	541
Applicability	541
Example	541
ntp master stratum	541
Command Syntax	541
Parameters	542
Default	542
Command Mode	542
Applicability	542
Example	542
ntp peer	542
Command Syntax	542
Parameters	542
Default	543
Command Mode	543
Applicability	543
Examples	543
ntp request-key	543
Command Syntax	544
Parameter	544
Default	544
Command Mode	544
Applicability	544
Example	544
ntp server	544
Command Syntax	544
Parameters	545
Default	545
Command Mode	545
Applicability	545
Examples	545

ntp sync-retry	546
Command Syntax	546
Parameter	546
Default	546
Command Mode	546
Applicability	546
Example	546
ntp trusted-key	546
Command Syntax	546
Parameter	546
Default	547
Command Mode	547
Applicability	547
Example	547
show ntp authentication-keys	547
Command Syntax	547
Parameters	547
Command Mode	547
Applicability	547
Example	547
show ntp authentication-status	548
Command Syntax	548
Parameters	548
Command Mode	548
Applicability	548
Example	548
show ntp logging-status	548
Command Syntax	548
Parameters	548
Command Mode	548
Applicability	549
Example	549
show ntp peer-status	549
Command Syntax	549
Parameters	549
Command Mode	549
Applicability	549
Example	549
show ntp peers	550
Command Syntax	550
Parameters	550
Command Mode	550
Applicability	550
Example	550
show ntp statistics	551
Command Syntax	551
Command Syntax	551

Command Mode	551
Applicability	551
Example	551
show ntp trusted-keys	553
Command Syntax	553
Command Syntax	553
Command Mode	553
Applicability	553
Example	553
show running-config ntp	553
Command Syntax	553
Command Syntax	553
Command Mode	553
Applicability	554
Example	554
Fault Management System Configuration	555
Fault Management System Configuration	556
Implementation Example	557
Enabling and Disabling the Fault Management System	557
Enabling FMS	557
Disabling FMS	557
Alarm Configuration File	557
Alarm Configuration File Template	557
Auto Generating the Alarm Configuration File	558
Alarm Configuration File Generation Steps	559
Sample oper_logs_list.yaml File	559
Alarm Descriptions	559
Event Manager	561
Overview	561
Feature Characteristics	561
Benefits	563
Configuration	563
Configuring Event Manager	563
Event Manager Commands	564
clear event-manager statistics	565
event-manager	566
event-manager action	567
event-manager event	568
show event-manager action	570
show event-manager event	572
show event-manager policy	574
show event-manager system-event-ids	575
Glossary	575
Fault Management System Command Reference	577
FMS Command Reference	578
fault-management (enable disable)	579

Command Syntax	579
Parameters	579
Default	579
Command Mode	579
Applicability	579
Example	579
fault-management close	580
Command Syntax	580
Parameters	580
Default	580
Command Mode	580
Applicability	580
Example	580
fault-management flush-db	582
Command Syntax	582
Parameters	582
Default	582
Command Mode	582
Applicability	582
Example	582
fault-management shelve	583
Command Syntax	583
Parameter	583
Default	583
Command Mode	583
Applicability	583
Examples	583
show alarm active	585
Command Syntax	585
Parameters	585
Default	585
Command Mode	585
Applicability	585
Example	585
show alarm closed	586
Command Syntax	586
Parameters	586
Default	586
Command Mode	586
Applicability	586
Example	586
show alarm history	587
Command Syntax	587
Parameters	587
Default	587
Command Mode	587
Applicability	587

Example	587
show alarm shelved	588
Command Syntax	588
Parameters	588
Default	588
Command Mode	588
Applicability	588
Example	588
show alarm statistics	589
Command Syntax	589
Parameters	589
Default	589
Command Mode	589
Applicability	589
Example	589
show alarm transitions	590
Command Syntax	590
Parameters	590
Default	590
Command Mode	590
Applicability	590
Example	590
show fms status	591
Command Syntax	591
Parameters	591
Default	591
Command Mode	591
Applicability	591
Example	591
show fms supported-alarm-types	592
Command Syntax	592
Parameters	592
Default	592
Command Mode	592
Applicability	592
Example	592
show running-config fault-management	593
Command Syntax	593
Parameters	593
Default	593
Command Mode	593
Applicability	593
Example	593
SNMP Configuration	594
Simple Network Management Protocol	595
Overview	595

Topology	596
VRP Management Standard Configuration	596
User Defined VRF Standard Configuration	596
Validation	597
SNMP GET Command	597
SNMP WALK Command	597
Complete SNMP WALK	598
SNMP Trap Server Configuration with IPv6 Address	598
Management VRF Configuration	598
Topology	598
SNMP Informs with IPv6 Address over User Defined VRF	600
Topology	600
SYSLOG MESSAGES OVER SNMP TRAPS	602
Topology	602
SNMP Traps Through different VRFs	604
SNMP Command Reference	606
Simple Network Management Protocol	607
debug snmp-server	609
Command Syntax	609
Parameters	609
Default	609
Command Mode	609
Applicability	609
Example	609
show running-config snmp	610
Command Syntax	610
Parameters	610
Command Mode	610
Applicability	610
Example	610
show snmp	611
Command Syntax	611
Parameters	611
Command Mode	611
Applicability	611
Examples	611
show snmp community	612
Command Syntax	612
Parameters	612
Command Mode	612
Applicability	612
Examples	612
show snmp context	613
Command syntax	613
Parameters	613
Command Mode	613

Applicability	613
Example	613
show snmp engine-id	614
Command Syntax	614
Parameters	614
Command Mode	614
Applicability	614
Examples	614
show snmp group	615
Command Syntax	615
Parameters	615
Command Mode	615
Applicability	615
Examples	615
show snmp host	616
Command Syntax	616
Parameters	616
Command Mode	616
Applicability	616
Examples	616
show snmp user	617
Command Syntax	617
Parameters	617
Command Mode	617
Applicability	617
Examples	617
show snmp view	618
Command Syntax	618
Parameters	618
Command Mode	618
Applicability	618
Examples	618
snmp context	619
Command Syntax	619
Parameters	619
Default	619
Command Mode	619
Applicability	619
Examples	619
snmp ent-ipi-iftable	620
Command Syntax	620
Parameters	620
Default	620
Command Mode	620
Applicability	620
Examples	620
snmp restart	621

Command Syntax	621
Parameters	621
Default	622
Command Mode	622
Applicability	622
Examples	622
snmp-server community	623
Command Syntax	623
Parameter	623
Default	624
Applicability	624
Examples	624
snmp-server community-map	625
Command Syntax	625
Parameters	625
Command Mode	625
Applicability	625
Examples	625
snmp-server contact	626
Command Syntax	626
Parameters	626
Default	626
Command Mode	626
Applicability	626
Examples	626
snmp-server context	627
Command Syntax	627
Parameters	627
Command Mode	627
Applicability	627
Examples	627
snmp-server disable default	628
Command Syntax	628
Parameter	628
Default	628
Command Mode	628
Applicability	628
Examples	628
snmp-server enable snmp	629
Command Syntax	629
Parameters	629
Default	629
Command Mode	629
Applicability	629
Examples	629
snmp-server enable traps	630
Command Syntax	630

Parameters	630
Default	631
Command Mode	631
Applicability	631
Examples	631
snmp-server engineID	632
Command Syntax	632
Command Syntax	632
Default	632
Command Mode	632
Applicability	632
Examples	632
snmp-server group	633
Command syntax	633
Parameters	633
Default	634
Command Mode	634
Applicability	634
Examples	634
snmp-server host	635
Command Syntax	635
Parameters	635
Default	636
Command Mode	636
Applicability	636
Examples	636
snmp-server location	637
Command Syntax	637
Parameters	637
Default	637
Command Mode	637
Applicability	637
Examples	637
snmp-server smux-port-disable	638
Command Syntax	638
Parameters	638
Default	638
Command Mode	638
Applicability	638
Examples	638
snmp-server tcp-session	639
Command Syntax	639
Parameters	639
Default	639
Command Mode	639
Applicability	639
Examples	639

snmp ent-ipi-iftable	640
Command Syntax	640
Parameter	640
Default	640
Command Mode	640
Applicability	640
Examples	640
snmp-server user	641
Command Syntax	641
Parameters	641
Default	641
Command Mode	642
Applicability	642
Examples	642
snmp-server view	643
Command Syntax	643
Parameters	643
Default	643
Command Mode	643
Applicability	643
Examples	643
Logging Server Configuration	645
Syslog Configuration	646
Overview	646
In-band Management over Default VRF	646
Syslog Configuration with IPv4 Address	646
Topology	646
Enabling rsyslog	646
Logging to a File	647
Logging to the Console	649
Logging to a Remote Server Via Management VRF	650
Logging to Remote Server via User-Defined VRF	650
Syslog Configuration with IPv6 Address	651
Topology	651
Enabling rsyslog	651
Logging to a File	652
Logging to Remote Server	652
Logging to Remote Server via Management VRF	653
Logging to Remote Server via User-Defined VRF	653
Custom Syslog Port Configuration	655
Overview	655
Support for In-band Management over default VRF	655
Features	655
Custom Syslog Configuration with IPv4 Address	655
Topology	656
Enabling rsyslog	656

Sample Output	657
Custom Syslog Configuration with IPv6 Address	657
Topology	658
Enabling rsyslog	658
Sample Output	659
Custom Syslog Configuration with HOSTNAME	659
Topology	660
Enabling rsyslog	660
Sample Output	661
Logging Server Command Reference	662
Syslog Commands	663
Syslog-Severities	664
Log File Rotation	665
clear logging logfile	667
Command Syntax	667
Parameters	667
Default	667
Command Mode	667
Applicability	667
Example	667
feature rsyslog	668
Command Syntax	668
Parameters	668
Default	668
Command Mode	668
Applicability	668
Example	668
logging console	669
Command Syntax	669
Parameters	669
Default	669
Command Mode	669
Applicability	669
Example	669
logging level	670
Command Syntax	670
Parameters	670
Default	671
Command Mode	671
Applicability	672
Examples	672
logging logfile	673
Command Syntax	673
Parameters	673
Default	673
Command Mode	673

Applicability	673
Examples	673
logging monitor	675
Command Syntax	675
Parameters	675
Default	675
Command Mode	675
Applicability	675
Example	675
logging remote facility	676
Command Syntax	676
Parameters	676
Default	676
Command Mode	676
Applicability	677
Examples	677
logging remote server	678
Command Syntax	678
Parameters	678
Default	679
Command Mode	679
Applicability	679
Examples	679
logging snmp-traps	680
Command Syntax	680
Parameters	680
Default	680
Command Mode	680
Applicability	680
Examples	680
logging timestamp	681
Command Syntax	681
Parameters	681
Default	681
Command Mode	681
Applicability	681
Examples	681
show logging	682
Command Syntax	682
Parameters	682
Command Mode	682
Applicability	682
Examples	682
show logging last	684
Command Syntax	684
Parameters	684
Command Mode	684

Applicability	684
Examples	684
show logging logfile	685
Command Syntax	685
Parameters	685
Command Mode	685
Applicability	685
Examples	685
show logging logfile last-index	686
Command Syntax	686
Parameters	686
Command Mode	686
Applicability	686
Examples	686
show logging logfile start-seqn end-seqn	687
Command Syntax	687
Parameters	687
Command Mode	687
Applicability	687
Examples	687
show logging logfile start-time end-time	688
Command Syntax	688
Parameters	688
Command Mode	688
Applicability	688
Examples	688
show running-config logging	690
Command Syntax	690
Parameters	690
Command Mode	690
Applicability	690
Examples	690
VLOG Commands	691
show vlog all	692
Command Syntax	692
Parameters	692
Default	692
Command Mode	692
Applicability	692
Example	692
show vlog clients	694
Command Syntax	694
Parameters	694
Default	694
Command Mode	694
Applicability	694
Example	694

show vlog terminals	695
Command Syntax	695
Parameters	695
Default	695
Command Mode	695
Applicability	695
Example	695
show vlog virtual-routers	696
Command Syntax	696
Parameters	696
Default	696
Command Mode	696
Applicability	696
Example	696
Monitor and Reporting Server Configuration	697
Software Monitoring and Reporting	698
Overview	698
Configuration	699
Validation	699
Configure sFlow for Single Collector	700
Overview	700
Topology	701
Configuration	701
sFlow Agent	701
Validation	701
Configure sFlow for Multiple Collectors	703
Overview	703
Feature Characteristics	703
Benefits	703
Prerequisites	703
sFlow Configuration	704
Topology	704
Validation	705
sFlow Multiple Collector Commands	705
sFlow Multiple Collector Commands with User Defined VRFs	706
Glossary	707
Control Plane Policing Configuration	708
Topology	708
Configuring CPU Queuing Lossless	711
Validation	711
Configuring CPU Queuing Lossy	712
Validation	712
Monitor and Reporting Server Command Reference	714
Software Monitoring and Reporting	716
clear cores	717
Command Syntax	717

Parameters	717
Default	717
Command Mode	717
Applicability	717
Example	717
copy core	718
Command Syntax	718
Parameters	718
Default	718
Command Mode	718
Applicability	718
Example	718
copy techsupport	720
Command Syntax	720
Parameters	720
Default	720
Command Mode	720
Applicability	720
Example	720
feature software-watchdog	722
Command Syntax	722
Parameters	722
Default	722
Command Mode	722
Applicability	722
Examples	722
remove file (techsupport)	723
Command Syntax	723
Parameter	723
Default	723
Command Mode	723
Applicability	723
Examples	723
show bootup-parameters	724
Command Syntax	724
Parameters	724
Command Mode	724
Applicability	724
Examples	724
show cores	725
Command Syntax	725
Parameters	725
Command Mode	725
Applicability	725
Examples	725
show running-config watchdog	726
Command Syntax	726

Parameters	726
Command Mode	726
Applicability	726
Examples	726
show software-watchdog status	727
Command Syntax	727
Parameters	727
Command Mode	727
Applicability	727
Examples	727
show system log	729
Command Syntax	729
Parameters	729
Command Mode	729
Applicability	729
Example	729
show system login	730
Command Syntax	730
Parameters	730
Command Mode	730
Applicability	730
Example	730
show system reboot-history	731
Command Syntax	731
Parameters	731
Command Mode	731
Applicability	731
Examples	731
show system resources	732
Command Syntax	732
Parameters	732
Command Mode	732
Applicability	732
Examples	732
show system uptime	734
Command Syntax	734
Parameters	734
Command Mode	734
Applicability	734
Examples	734
show techsupport	735
Command Syntax	735
Parameters	735
Default	736
Command Mode	736
Applicability	736
Example	737

show techsupport status	738
Command Syntax	738
Parameters	738
Command Mode	738
Applicability	738
Example	738
software-watchdog	739
Command Syntax	739
Default	740
Command Mode	740
Applicability	740
Examples	740
software-watchdog keep-alive-time	741
Command Syntax	741
Parameters	741
Default	741
Command Mode	741
Applicability	741
Examples	741
sFlow Commands	742
clear sflow statistics	743
Command Syntax	743
Parameter	743
Default	743
Command Mode	743
Applicability	743
Example	743
debug sflow	744
Command Syntax	744
Parameters	744
Default	744
Command Mode	744
Applicability	744
Example	744
feature sflow	745
Command Syntax	745
Parameters	745
Default	745
Command Mode	745
Applicability	745
Example	745
sflow agent-ip	746
Command Syntax	746
Parameter	746
Default	746
Command Mode	746
Applicability	746

Example	746
sflow collector	747
Command Syntax	747
Parameter	747
Default	747
Command Mode	747
Applicability	747
Example	748
sflow enable	749
Command Syntax	749
Parameters	749
Default	749
Command Mode	749
Applicability	749
Example	749
sflow poll-interval	750
Command Syntax	750
Parameters	750
Default	750
Command Mode	750
Applicability	750
Examples	750
sflow rate-limit	751
Command Syntax	751
Parameters	751
Default	751
Command Mode	751
Applicability	751
Examples	751
sflow sampling-rate	752
Command Syntax	752
Parameters	752
Default	752
Command Mode	752
Applicability	752
Examples	752
show sflow	754
Command Syntax	754
Parameters	754
Default	754
Command Mode	754
Applicability	754
Example	754
show sflow interface	756
Command Syntax	756
Parameters	756
Default	756

Command Mode	756
Applicability	756
Example	756
show sflow global	757
Command Syntax	757
Parameters	757
Default	757
Command Mode	757
Applicability	757
Example	757
show sflow statistics	758
Command Syntax	758
Parameters	758
Default	758
Command Mode	758
Applicability	758
Example	758
Control Plane Policing Commands	759
class-map type	760
Command Syntax	760
Parameter	760
Default	760
Command Mode	760
Applicability	760
Examples	760
class type copp	761
Command Syntax	761
Parameter	761
Default	761
Command Mode	761
Applicability	761
Examples	761
clear interface cpu counters	762
Command Syntax	762
Parameters	762
Default	762
Command Mode	762
Applicability	762
Example	762
copp service-policy	763
Command Syntax	763
Parameter	763
Default	763
Command Mode	763
Applicability	763
Examples	763
cpu-queue	764

Command Syntax	764
Parameters	764
Default	765
Command Mode	765
Applicability	765
Example	765
match access-group	767
Command Syntax	767
Parameter	767
Default	767
Command Mode	767
Applicability	767
Examples	767
ip copp access-list	768
Command Syntax	768
Parameters	768
Default	769
Command Mode	769
Applicability	769
Examples	769
ip copp access-list icmp	770
Command Syntax	770
Parameters	770
Default	773
Command Mode	773
Applicability	773
Examples	773
ip copp access-list tcp udp	774
Command Syntax	774
Parameters	775
Default	779
Command Mode	779
Applicability	779
Examples	779
police	780
Command Syntax	780
Parameter	780
Default	780
Command Mode	780
Applicability	780
Examples	780
policy-map	781
Command Syntax	781
Parameter	781
Default	781
Command Mode	781
Applicability	781

Examples	781
show interface cpu counters queue-stats	782
Command Syntax	782
Parameters	782
Default	782
Command Mode	782
Applicability	782
Example	782
show cpu-queue details	783
Command Syntax	783
Parameters	783
Default	783
Command Mode	783
Applicability	783
Example	783
Object Tracking Commands	785
track ip sla reachability	786
Command Syntax	786
Parameters	786
Command Mode	786
Applicability	786
Example	786
delay up down	787
Command Syntax	787
Parameters	787
Default	787
Command Mode	787
Applicability	787
Example	787
object tracking	788
Command Syntax	788
Parameters	788
Default	788
Command Mode	788
Applicability	788
Example	788
show track	790
Command Syntax	790
Parameters	790
Default	790
Command Mode	790
Applicability	790
Example	790
show track summary	791
Command Syntax	791
Parameters	791
Default	791

Command Mode	791
Applicability	791
Example	791
show running-config track	792
Command Syntax	792
Parameters	792
Default	792
Command Mode	792
Applicability	792
Example	792
IP Service Level Agreements Commands	793
clear ip sla statistics	794
Command Syntax	794
Parameters	794
Default	794
Command Mode	794
Applicability	794
Examples	794
frequency	795
Command Syntax	795
Parameters	795
Default	795
Command Mode	795
Applicability	795
Examples	795
icmp-echo	796
Command Syntax	796
Parameters	796
Default	796
Command Mode	796
Applicability	796
Examples	796
ip sla	797
Command Syntax	797
Parameters	797
Default	797
Command Mode	797
Applicability	797
Example	797
ip sla schedule	798
Command Syntax	798
Parameters	798
Default	798
Command Mode	798
Applicability	798
Examples	798
show ip sla statistics	799

Command Syntax	799
Parameters	799
Default	799
Command Mode	799
Applicability	799
Examples	799
show ip sla summary	801
Command Syntax	801
Parameters	801
Default	801
Command Mode	801
Applicability	801
Examples	801
show running-config ip sla	802
Command Syntax	802
Parameters	802
Default	802
Command Mode	802
Applicability	802
Examples	802
threshold	803
Command Syntax	803
Parameters	803
Default	803
Command Mode	803
Applicability	803
Examples	803
timeout	804
Command Syntax	804
Parameters	804
Default	804
Command Mode	804
Applicability	804
Examples	804
Hardware System Diagnose Configuration	805
Show Tech Support Configurations	806
Overview	806
Tech Support Samples	806
Ethernet Interface Loopback Support	808
Overview	808
Local Loopback	808
Tx PHY Loopback	808
Tx MAC Loopback	808
Remote Loopback	809
Rx PHY Loopback	809
Rx MAC Loopback	809

Topology	809
Configurations	809
Validation	811
Interface counters after configuring loopback tx phy	813
Removing the Loopback Configuration	813
Loopback tx mac	813
Validation	813
Interface counters before configuring on both the devices	815
Interface counters after configuring loopback tx phy	815
Hardware System Diagnose Command Reference	816
Chassis Management Module Commands	818
cpu-core-usage	819
Command Syntax	819
Parameters	819
Default	819
Command Mode	819
Applicability	819
Example	819
debug cmm	821
Command Syntax	821
Parameters	821
Command Mode	821
Applicability	821
Example	821
locator led	822
Command Syntax	822
Parameters	822
Default	822
Command Mode	822
Applicability	822
Example	822
show hardware-information	823
Command Syntax	823
Parameters	823
Default	823
Command Mode	823
Applicability	823
Example	823
show system-information	839
Command Syntax	839
Parameter	839
Default	839
Command Mode	839
Applicability	839
Example	839
system-load-average	844

Command Syntax	844
Parameters	844
Default	844
Command Mode	844
Applicability	844
Example	844
Modifying Temperature Sensor Threshold Value	846
Overview	846
Feature Characteristics	846
Benefits	846
Prerequisites	846
temperature threshold	846
emer-max	848
emer-min	848
alrt-max	849
alrt-min	850
crit-max	851
crit-min	851
temperature policy (sys-reboot sys-halt none)	852
temperature policy (sys-reboot sys-halt none)	853
Command Syntax	853
Parameters	853
Default	853
Command Mode	853
Applicability	853
Examples	854
Glossary	854
Digital Diagnostic Monitoring Commands	855
clear ddm transceiver alarm	856
Command Syntax	856
Parameters	856
Default	856
Command Mode	856
Applicability	856
Example	856
clear ddm transceiver alarm all	857
Command Syntax	857
Parameters	857
Default	857
Command Mode	857
Applicability	857
Example	857
ddm monitor	858
Command Syntax	858
Parameters	858
Default	858
Command Mode	858

Applicability	858
Example	858
ddm monitor all	859
Command Syntax	859
Parameters	859
Default	859
Command Mode	859
Applicability	859
Example	859
ddm monitor interval	860
Command Syntax	860
Parameters	860
Default	860
Command Mode	860
Applicability	860
Example	860
ddm raise	861
Command Syntax	861
Parameters	861
Default	861
Command Mode	861
Applicability	861
Example	861
debug ddm	862
Command Syntax	862
Parameters	862
Default	862
Command Mode	862
Applicability	862
Example	862
service unsupported-transceiver	863
Command Syntax	863
Parameters	863
Default	863
Command Mode	863
Applicability	863
Example	863
show controller details	864
Command Syntax	864
Parameters	864
Default	864
Command Mode	864
Applicability	864
Example	864
show interface all transceiver detail	865
Command Syntax	865
Parameters	865

Default	865
Command Mode	865
Applicability	865
Example	865
show interface controller details	866
Command Syntax	866
Parameters	866
Default	866
Command Mode	866
Applicability	866
Example	866
show interface frequency grid	868
Command Syntax	868
Parameters	868
Default	868
Command Mode	868
Applicability	868
Example	868
show interface transceiver details	870
Command Syntax	870
Parameters	870
Default	870
Command Mode	870
Applicability	870
Example	870
show interface transceiver detail remote	873
Command Syntax	873
Parameters	873
Default	873
Command Mode	873
Applicability	873
Example	873
show interface transceiver protocol	874
Command Syntax	874
Parameters	874
Default	874
Command Mode	874
Applicability	874
Example	874
show interface transceiver protocol remote	875
Command Syntax	875
Parameters	875
Default	875
Command Mode	875
Applicability	875
Example	875
show interface transceiver protocol stats	876

Command Syntax	876
Parameters	876
Default	876
Command Mode	876
Applicability	876
Example	876
show interface transceiver remote	877
Command Syntax	877
Parameters	877
Default	877
Command Mode	877
Applicability	877
Example	877
show interface transceiver threshold violations remote	878
Command Syntax	878
Parameters	878
Default	878
Command Mode	878
Applicability	878
Example	878
show supported-transceiver	879
Command Syntax	879
Parameters	879
Default	879
Command Mode	879
Applicability	879
Example	879
tx-disable	880
Command Syntax	880
Parameters	880
Default	880
Command Mode	880
Applicability	880
Example	880
xcvr <IFNAME> tx-disable <1-256> remote	881
Command Syntax	881
Parameters	881
Default	881
Command Mode	881
Applicability	881
Example	881
xcvr <IFNAME> reset remote	882
Command Syntax	882
Command Syntax	882
Default	882
Command Mode	882
Applicability	882

Example	882
xcvr loopback	883
Command Syntax	883
Parameters	883
Default	883
Command Mode	883
Applicability	883
Example	883
wavelength	884
Command Syntax	884
Parameters	884
Default	884
Command Mode	884
Applicability	884
Example	884
Link Configuration Guide	885
Trigger Failover Configuration	886
Basic Configuration	886
Switch	886
Validation	887
Port-Channel Configuration	887
Topology	887
Validation	889
Link Detection Debounce Timer	891
Topology	891
Configuration	891
RTR1	891
RTR2	892
Validation	892
Log Messages	892
Example Log Messages	892
Link Command Reference	894
Trigger Failover Commands	895
clear tfo counter	895
Command Syntax	895
Parameters	895
Default	895
Command Mode	895
Applicability	895
Example	895
fog	895
Command Syntax	896
Parameters	896
Default	896
Command Mode	896
Applicability	896

Example	896
fog tfc	896
Command Syntax	897
Parameters	897
Default	897
Command Mode	897
Applicability	897
Example	897
fog type	897
Command Syntax	897
Parameters	897
Default	898
Command Mode	898
Applicability	898
Example	898
link-type	898
Command Syntax	898
Parameters	898
Default	898
Command Mode	898
Applicability	898
Example	898
show tfo	899
Command Syntax	899
Parameters	899
Default	899
Command Mode	899
Applicability	899
Example	899
tfo	900
Command Syntax	900
Parameters	900
Default	900
Command Mode	900
Applicability	900
Example	900
QSFP-DD Configuration Guide	901
QSFP-DD Configuration	902
Overview	902
System Description	902
Host Interface (Device to device interconnection)	902
Media Interface (Device to media interconnection)	902
Objectives	902
Topology	902
Loopback	903
Media Input Loopback	903

Media Output Loopback	903
Media Both Loopback	904
Validation of Media Both Loopback	904
Host Input Loopback	904
Host Output Loopback	905
Host Both Loopback	905
PRBS	906
PRBS Host Checker & Generator	906
Unconfigure PRBS Host Checker & Generator	907
PRBS Media Checker & Generator	909
Unconfigure PRBS Media Checker & Generator	910
EEPROM Details for a ZR+ Optics	912
Application	912
Configuration	913
Custom Application	915
Overview	915
Configurations	915
Validation	916
Implementation Examples	916
Custom Application Advertisement Details	916
Laser Tuning	917
Laser Grid Configuration	917
Laser Grid Unconfiguration	918
Laser Channel Configuration	918
Laser Channel Unconfiguration	919
Laser Fine-tune-freq Configuration	919
Laser Fine-tune-freq Unconfiguration	920
Laser Output-power Configuration	920
Laser Output-power Unconfiguration	921
Laser Grid at Media-lane Configuration	921
Laser Grid at Media-lane Unconfiguration	922
Laser Channel at Media-lane Configuration	922
Laser Channel at Media-lane Unconfiguration	923
Laser Fine-tune-freq at Media-lane Configuration	923
Laser Fine-tune-freq at Media-lane Unconfiguration	924
Laser Output-power at Media-lane Configuration	924
Laser Output-power at Media-lane Unconfiguration	925
QSFP-DD Monitored Alarms	925
Example	928
Remote Fault and Local Fault Alarms	932
Overview	932
Validation	932
Signal Integrity in QSFP-DD	950
Overview	950
Configuration	951
400G PM Alarm	979
Overview	979

Feature Characteristics	979
Benefits	979
Prerequisites	979
Configuration	980
Topology	980
Media-lane Configuration	980
Host-lane Configuration	981
Global Threshold Configuration	983
New CLI Commands	985
ha	987
hw	988
la	989
lw	990
show qsf-p-dd user-threshold status	991
threshold (host-lane mode)	993
threshold (media-lane mode)	994
threshold (QSFP-DD mode)	996
Abbreviations	998
QSFP-DD Command Reference	999
QSFP-DD Commands	1001
application	1003
Command Syntax	1005
Parameters	1005
Command Mode	1005
Default	1005
Applicability	1005
Example	1005
ha	1007
Command Syntax	1007
Parameters	1007
Command Mode	1007
Applicability	1007
Example	1007
hw	1008
Command Syntax	1008
Parameters	1008
Command Mode	1008
Applicability	1008
Example	1008
la	1009
Command Syntax	1009
Parameters	1009
Command Mode	1009
Applicability	1009
Example	1009
laser channel	1010

Command Syntax	1010
Parameters	1010
Default	1010
Command Mode	1010
Applicability	1010
Examples	1010
laser grid	1011
Command Syntax	1011
Parameters	1011
Default	1011
Command Mode	1011
Applicability	1011
Examples	1012
laser fine-tune-freq	1013
Command Syntax	1013
Parameters	1013
Default	1013
Command Mode	1013
Applicability	1013
Examples	1013
laser output-power	1014
Command Syntax	1014
Parameters	1014
Default	1014
Command Mode	1014
Applicability	1014
Examples	1014
loopback	1015
Command Syntax	1015
Parameters	1015
Command Mode	1015
Applicability	1015
Example	1015
lw	1016
Command Syntax	1016
Parameters	1016
Command Mode	1016
Applicability	1016
Example	1016
prbs	1017
Command Syntax	1017
Parameters	1017
Command Mode	1018
Applicability	1018
Example	1018
qsfp-dd	1019
Command Syntax	1019

Parameters	1019
Command Mode	1019
Applicability	1019
Example	1019
rx-output eq-pre-cursor-target	1020
Command Syntax	1020
Parameters	1020
Default	1020
Command Mode	1020
Applicability	1020
Example	1020
rx-output eq-post-cursor-target	1021
Command Syntax	1021
Parameters	1021
Default	1021
Command Mode	1021
Applicability	1021
Example	1021
rx-output amp-target	1022
Command Syntax	1022
Parameters	1022
Default	1022
Command Mode	1022
Applicability	1022
Example	1022
rx cdr-bypass	1023
Command Syntax	1023
Parameters	1023
Command Mode	1023
Applicability	1023
Example	1023
show qsfdd advertisement applications	1024
Command Syntax	1024
Parameters	1024
Command Mode	1024
Applicability	1024
Example	1024
show qsfdd advertisement controls	1029
Command Syntax	1029
Parameters	1029
Command Mode	1029
Applicability	1029
Example	1029
show qsfdd advertisement diagnostics host	1030
Command Syntax	1030
Parameters	1030
Command Mode	1030

Applicability	1030
Example	1030
show qsf-p-dd advertisement diagnostics media	1031
Command Syntax	1031
Parameters	1031
Command Mode	1031
Applicability	1031
Example	1031
show qsf-p-dd advertisement diagnostics module	1032
Command Syntax	1032
Parameters	1032
Command Mode	1032
Applicability	1032
Example	1032
show qsf-p-dd advertisement durations	1033
Command Syntax	1033
Parameters	1033
Command Mode	1033
Applicability	1033
Example	1033
show qsf-p-dd advertisement laser	1034
Command Syntax	1034
Parameters	1034
Command Mode	1034
Applicability	1034
Example	1034
show qsf-p-dd advertisement monitors host	1035
Command Syntax	1035
Parameters	1035
Command Mode	1035
Applicability	1035
Example	1035
show qsf-p-dd advertisement monitors media	1036
Command Syntax	1036
Parameters	1036
Command Mode	1036
Applicability	1036
Example	1036
show qsf-p-dd advertisement monitors module	1038
Command Syntax	1038
Parameters	1038
Command Mode	1038
Applicability	1038
Example	1038
show qsf-p-dd advertisement pages	1039
Command Syntax	1039
Parameters	1039

Command Mode	1039
Applicability	1039
Example	1039
show qsfdd advertisement si	1040
Command Syntax	1040
Parameters	1040
Command Mode	1040
Applicability	1040
Example	1040
show qsfdd si status	1042
Command Syntax	1042
Parameters	1042
Command Mode	1042
Applicability	1042
Example	1042
show qsfdd application	1044
Command Syntax	1044
Parameters	1044
Command Mode	1044
Applicability	1044
Example	1044
show qsfdd diagnostics host	1045
Command Syntax	1045
Parameters	1045
Command Mode	1045
Applicability	1045
Example	1045
show qsfdd diagnostics media	1047
Command Syntax	1047
Parameters	1047
Command Mode	1047
Applicability	1047
Example	1047
show qsfdd eeprom	1048
Command Syntax	1048
Parameters	1048
Command Mode	1048
Applicability	1048
Example	1048
show qsfdd laser grid	1049
Command Syntax	1049
Parameters	1049
Default	1049
Command Mode	1049
Applicability	1049
Example	1049
show qsfdd laser status	1051

Command Syntax	1051
Parameters	1051
Default	1051
Command Mode	1051
Applicability	1051
Example	1051
show qsf-p-dd monitors host	1052
Command Syntax	1052
Parameters	1052
Command Mode	1052
Applicability	1052
Example	1052
show qsf-p-dd monitors media	1054
Command Syntax	1054
Parameters	1054
Command Mode	1054
Applicability	1054
Example	1054
show qsf-p-dd monitors module	1056
Command Syntax	1056
Parameters	1056
Command Mode	1056
Applicability	1056
Example	1056
show qsf-p-dd state	1057
Command Syntax	1057
Parameters	1057
Command Mode	1057
Applicability	1057
Example	1057
show qsf-p-dd user-threshold status	1058
Command Syntax	1058
Parameters	1058
Command Mode	1058
Applicability	1058
Example	1058
tx-input eq-target	1060
Command Syntax	1060
Parameters	1060
Default	1060
Command Mode	1060
Applicability	1060
Example	1060
tx cdr-bypass	1061
Command Syntax	1061
Parameters	1061
Command Mode	1061

Applicability	1061
Example	1061
threshold (host-lane mode)	1062
Command Syntax	1062
Parameters	1062
Command Mode	1062
Applicability	1062
Example	1062
threshold (media-lane mode)	1063
Command Syntax	1063
Parameters	1063
Command Mode	1063
Applicability	1063
Example	1063
threshold (QSFP-DD mode)	1065
Command Syntax	1065
Parameters	1065
Command Mode	1065
Applicability	1065
Example	1065
EDFA Configuration Guide	1067
Erbium-Doped Fiber Amplifier (EDFA) Configuration	1068
Overview	1068
System Description	1068
Automatic Power Control	1068
Automatic Gain Control	1068
Objectives	1068
Topology	1069
Configuration	1069
R1	1069
Validation	1070
Verify R1 Router for AGC Mode	1070
Verify R1 Router for APC Mode	1070
EDFA Command Reference	1072
Erbium-doped Fiber Amplifier Commands	1073
edfa operating-mode	1074
Command Syntax	1074
Parameters	1074
Default	1074
Command Mode	1074
Applicability	1074
Example	1074
edfa target-gain	1075
Command Syntax	1075
Parameters	1075
Default	1075

Command Mode	1075
Applicability	1075
Example	1075
edfa target-outpwr	1076
Command Syntax	1076
Parameters	1076
Default	1076
Command Mode	1076
Applicability	1076
Example	1076
show edfa operating-mode	1077
Command Syntax	1077
Parameters	1077
Default	1077
Command Mode	1077
Applicability	1077
Example	1077
show interface transceiver detail	1078
Command Syntax	1078
Parameters	1078
Default	1078
Command Mode	1078
Applicability	1078
Example	1078
show interface transceiver threshold violations	1080
Command Syntax	1080
Parameters	1080
Default	1080
Command Mode	1080
Applicability	1080
Example	1080
show interface transceiver	1081
Command Syntax	1081
Parameters	1081
Default	1081
Command Mode	1081
Applicability	1081
Example	1081
show interface all transceiver	1083
Command Syntax	1083
Parameters	1083
Default	1083
Command Mode	1083
Applicability	1083
Example	1083
show interface all transceiver detail	1084
Command Syntax	1084

Parameters	1084
Default	1084
Command Mode	1084
Applicability	1084
Example	1084
show interface all transceiver threshold violations	1085
Command Syntax	1085
Parameters	1085
Default	1085
Command Mode	1085
Applicability	1085
Example	1085
NetConf Configuration	1086
NetConf Call Home Configuration	1087
User Management VRF Configuration	1087
Validation	1087
User Defined VRF Configuration	1088
Validation	1088
Start the Call Home Server	1089
NetConf sget Output	1089
Stop the Call Home Server	1089
NetConf Port Access Control	1091
Overview	1091
Feature Characteristics	1091
Benefits	1091
Configuration	1091
Topology	1092
Enable Netconf-ssh on the default and vrf management port	1092
Enable Netconf-tls on the default and vrf management port	1092
Disable netconf-ssh via default and vrf management port	1095
Disable netconf-tls via default port and vrf management port	1095
Configuring NetConf Port	1095
Ping between two nodes via Yang CLI	1097
ACL Rule with IPv4 Configuration	1099
R2	1101
R3	1101
Implementation Examples	1104
Accessing R1 from R2 with default port	1104
Accessing R1 from R2 with user defined port	1104
Applying ACL rule to permit or deny any Node	1104
New CLI Commands	1105
feature netconf-ssh	1106
feature netconf-tls	1107
netconf-ssh port	1109
netconf-tls port	1110
show netconf server	1111

show running-config netconf server	1112
Revised CLI Commands	1113
ip access-list tcp udp	1113
Abbreviations	1113
NetConf Command Reference	1114
NetConf Call Home Commands	1115
callhome server	1116
Command Syntax	1116
Parameters	1116
Default	1116
Command Mode	1116
Applicability	1116
Example	1116
debug callhome	1118
Command Syntax	1118
Parameters	1118
Default	1118
Command Mode	1118
Applicability	1118
Example	1118
feature netconf callhome	1120
management-port	1122
Command Syntax	1122
Parameters	1122
Default	1122
Command Mode	1122
Applicability	1122
Example	1122
netconf callhome	1124
Command Syntax	1124
Command Mode	1124
Applicability	1124
Example	1124
reconnect	1125
Command Syntax	1125
Parameters	1125
Default	1125
Command Mode	1125
Applicability	1125
Example	1125
retry-interval	1127
Command Syntax	1127
Parameters	1127
Default	1127
Mode	1127
Applicability	1127

Example	1127
retry-max-attempts	1129
Command Syntax	1129
Parameters	1129
Default	1129
Command Mode	1129
Applicability	1129
Example	1129
show (xml) running-config netconf-callhome	1131
Command Syntax	1131
Parameters	1131
Command Mode	1131
Applicability	1131
Example	1131
Security Management Configuration	1132
Access Control Lists Configurations	1134
Overview	1134
Topology	1134
IPv4 ACL Configuration	1134
Validation	1135
ICMP ACL Configuration	1135
Validation	1136
Access List Entry Sequence Numbering	1136
Validation	1136
IPv6 ACL Configuration	1137
Validation	1137
MAC ACL Configuration	1138
Validation	1138
Management ACL Overview	1139
Topology	1139
Management ACL Configuration	1139
Validation	1140
ARP ACL Overview	1143
Topology	1143
ARP ACL Configuration	1143
Validation	1144
ACL OVER LOOPBACK	1144
Topology	1144
Loopback ACL Configuration	1144
Validation	1145
ACL OVER VTY	1146
Topology	1147
VTY ACL Configuration	1147
Validation	1147
Implementation Examples	1148
Timed ACL	1148

Topology	1148
Configuration with ipv4 Address	1148
Configuration with ipv6 Address	1149
Configuration with mac	1149
Validation	1149
ACL on IRB Interface over VXLAN EVPN	1151
Topology	1151
ACLs Configuration on IRB	1151
Configuration Snapshot	1153
Validation	1157
Dynamic ARP Inspection	1159
Overview	1159
Topology	1159
Enable/Disable the Ingress DHCP-snoop TCAM group	1159
Enable/Disable the Ingress DHCP-snoop-IPv6 TCAM group	1160
Enable DHCP Snooping and DAI Globally	1160
Enable DHCP Snooping and DAI on a VLAN	1160
Validation	1160
Enable/Disable IP DHCP Snooping ARP-inspection Validate	1161
Configuring the Ports Connected to DHCP Server and DHCP Client	1161
Configuring Trusted and Un-trusted Ports	1162
Validation	1162
Proxy ARP and Local Proxy ARP	1163
Overview	1163
Topology	1163
Host A	1163
Host B	1163
Enable Proxy ARP	1164
Validation	1164
Local Proxy ARP Overview	1165
Topology	1165
Validation	1167
DHCP Snooping	1168
Overview	1168
Topology	1169
Configuration	1169
Procedures	1169
Enable DHCP Snooping Globally	1169
Enable DHCP Snooping on a VLAN	1170
Validation	1170
Configuring the Ports Connected to DHCP Server and DHCP Client	1171
Configuring Trusted and Un-trusted Ports	1172
IDHCP Snooping Operation	1173
Validation	1173
DHCP Snooping with Option-82	1175
Procedures	1176
Enable DHCP Snooping Globally	1176

Enable DHCP Snooping on a VLAN	1176
Configure Ports connected to DHCP Server and DHCP Client	1176
Configure Trusted and Untrusted Ports	1176
Enable option-82	1177
Validation	1178
Sample server dhcpd.conf for option-82	1180
DHCP Snooping IP Source Guard	1181
Overview	1181
Topology	1181
Configuring the Ports Connected to DHCP Server and DHCP Client	1182
Validation	1183
Configuring Trusted and Un-trusted Ports	1184
Validation	1184
Configuring IP Source Guard on LAG Port	1185
Validation	1186
DHCP Snooping over MLAG	1187
Overview	1187
Configuration	1188
Topology	1188
Configuring DHCP snooping over MLAG	1188
Static MLAG configuration for TOR1 and TOR2	1193
Validation	1194
No IP Unreachable	1199
Overview	1199
Supported ICMP Unreachable Codes	1199
Supported ICMPv6 Unreachable Codes	1200
Feature Characteristics	1200
Benefits	1200
Configuration	1200
Example for Suppressing the ICMP Destination Host Unreachable Message	1201
Example for Suppressing the ICMP Destination Network Unreachable Message	1201
Example for Suppressing the ICMP Fragmentation Needed Message	1201
Topology	1202
Configurations	1202
Configuring No IP/IPv6 Unreachable	1202
Validation	1203
No IP Unreachable Unconfiguration	1203
Validation	1203
No IPv6 Unreachable Unconfiguration	1204
CLI Commands	1204
no ip unreachable	1204
no ipv6 unreachable	1205
Port Breakout Configuration	1206
VLAN Port Breakout Configuration	1207
Overview	1207
Terminology	1207
Prerequisite	1208

Configure VLAN Reservation	1208
Configure Port Breakout	1209
Configure Port Breakout at Global Configuration Level	1209
Unconfigure VLAN Reservation	1211
Unconfigure Port Breakout	1211
Port Breakout (100G and 400G) on Tomahawk and Trident Series Platforms	1215
Overview	1215
Feature Characteristics	1216
Benefits	1216
Platform-Specific Details 100G Port	1217
Platform-Specific Details 400G Port	1218
Key Considerations	1219
Configuration	1220
Configuration for Global-Level Breakout (No Reload Required)	1221
Unconfigure Port Breakout through Global Level	1222
Configuration for Interface-Level Breakout	1223
Unconfigure Port Breakout through Interface Level	1224
Security Management Command Reference	1225
Access Control List Commands (XGS)	1228
access-list logging cache-size	1230
Command Syntax	1230
Parameters	1230
Default	1230
Command Mode	1230
Applicability	1230
Examples	1230
access-list logging rate-limit	1231
Command Syntax	1231
Parameters	1231
Default	1231
Command Mode	1231
Applicability	1231
Examples	1231
arp access-group	1232
Command Syntax	1232
Parameters	1232
Command Mode	1232
Applicability	1232
Example	1232
arp access-list	1233
Command Syntax	1233
Parameters	1233
Command Mode	1233
Applicability	1233
Example	1233
arp access-list filter	1234

Command Syntax	1234
Parameters	1234
Command Mode	1235
Applicability	1235
Example	1235
arp access-list remark	1236
Command Syntax	1236
Parameters	1236
Command Mode	1236
Applicability	1236
Example	1236
arp access-list request	1237
Command Syntax	1237
Parameters	1237
Command Mode	1238
Applicability	1238
Examples	1238
arp access-list resequence	1239
Command Syntax	1239
Parameters	1239
Command Mode	1239
Applicability	1239
Example	1239
arp access-list response	1240
Command Syntax	1240
Parameters	1240
Command Mode	1241
Applicability	1241
Example	1241
clear access-list	1242
Command Syntax	1242
Parameters	1242
Command Mode	1242
Applicability	1242
Examples	1242
clear access-list log-cache	1243
Command Syntax	1243
Parameters	1243
Command Mode	1243
Applicability	1243
Examples	1243
clear arp access-list	1244
Command Syntax	1244
Parameters	1244
Command Mode	1244
Applicability	1244
Example	1244

clear ip access-list	1245
Command Syntax	1245
Parameters	1245
Command Mode	1245
Applicability	1245
Examples	1245
clear ipv6 access-list	1246
Command Syntax	1246
Parameters	1246
Command Mode	1246
Applicability	1246
Examples	1246
clear mac access-list	1247
Command Syntax	1247
Parameters	1247
Command Mode	1247
Applicability	1247
Examples	1247
ip access-group	1248
Command Syntax	1248
Parameter	1248
Command Mode	1248
Applicability	1248
Examples	1248
ip access-list	1251
Command Syntax	1251
Parameters	1251
Default	1251
Command Mode	1251
Applicability	1251
Examples	1251
ip access-list default	1252
Command Syntax	1252
Parameters	1252
Default	1252
Command Mode	1252
Applicability	1252
Examples	1252
ip access-list filter	1253
Command Syntax	1253
Parameters	1253
Default	1256
Command Mode	1256
Applicability	1256
Examples	1256
ip access-list fragments	1257
Command Syntax	1257

Parameters	1257
Command Mode	1257
Applicability	1257
Examples	1257
ip access-list icmp	1258
Command Syntax	1258
Parameters	1258
Default	1263
Command Mode	1263
Applicability	1263
Examples	1263
ip access-list remark	1264
Command Syntax	1264
Parameters	1264
Default	1264
Command Mode	1264
Applicability	1264
Examples	1264
ip access-list resequence	1265
Command Syntax	1265
Parameters	1265
Default	1265
Command Mode	1265
Applicability	1265
Examples	1265
ip access-list tcp udp	1266
Command Syntax	1266
Parameters	1267
Default	1273
Command Mode	1273
Applicability	1273
Examples	1273
ipv6 access-group	1274
Command Syntax	1274
Parameters	1274
Default	1274
Command Mode	1274
Applicability	1274
Examples	1275
ipv6 access-list	1276
Command Syntax	1276
Parameters	1276
Default	1276
Command Mode	1276
Applicability	1277
Examples	1277
ipv6 access-list default	1278

Command Syntax	1278
Parameter	1278
Default	1278
Command Mode	1278
Applicability	1278
Examples	1278
ipv6 access-list filter	1279
Command Syntax	1279
Parameters	1279
Default	1282
Command Mode	1282
Applicability	1282
Examples	1282
ipv6 access-list fragments	1283
Command Syntax	1283
Parameters	1283
Command Mode	1283
Applicability	1283
Examples	1283
ipv6 access-list icmpv6	1284
Command Syntax	1284
Parameters	1284
Default	1287
Command Mode	1288
Applicability	1288
Examples	1288
ipv6 access-list remark	1289
Command Syntax	1289
Command Syntax	1289
Default	1289
Command Mode	1289
Applicability	1289
Examples	1289
ipv6 access-list resequence	1290
Command Syntax	1290
Parameter	1290
Default	1290
Command Mode	1290
Applicability	1290
Examples	1290
ipv6 access-list sctp	1291
Command Syntax	1291
Parameters	1291
Default	1293
Command Mode	1294
Applicability	1294
Examples	1294

ipv6 access-list tcp udp	1295
Command Syntax	1295
Parameters	1296
Default	1302
Command Mode	1302
Applicability	1303
Examples	1303
line vty	1304
Command Syntax	1304
Parameters	1304
Command Mode	1304
Applicability	1304
Examples	1304
mac access-group	1305
Command Syntax	1305
Parameters	1305
Default	1306
Command Mode	1306
Applicability	1306
Examples	1306
mac access-list	1307
Command Syntax	1307
Parameters	1307
Default	1307
Command Mode	1307
Applicability	1307
Examples	1307
mac access-list default	1308
Command Syntax	1308
Parameters	1308
Default	1308
Command Mode	1308
Applicability	1308
Examples	1308
mac access-list filter	1309
Command Syntax	1309
Parameter	1309
Default	1311
Command Mode	1311
Applicability	1311
Examples	1311
mac access-list remark	1312
Command Syntax	1312
Parameters	1312
Default	1312
Command Mode	1312
Applicability	1312

Examples	1312
mac access-list resequence	1313
Command Syntax	1313
Parameters	1313
Default	1313
Command Mode	1313
Applicability	1313
Examples	1313
show access-list log-cache	1314
Command Syntax	1314
Parameters	1314
Command Mode	1314
Applicability	1314
Example	1314
show access-lists	1315
Command Syntax	1315
Parameters	1315
Default	1315
Command Mode	1315
Applicability	1315
Example	1315
show arp access-lists	1317
Command Syntax	1317
Parameters	1317
Command Mode	1317
Applicability	1317
Example	1317
show ip access-lists	1318
Command Syntax	1318
Parameters	1318
Default	1318
Command Mode	1318
Applicability	1318
Example	1318
show ipv6 access-lists	1319
Command Syntax	1319
Parameters	1319
Default	1319
Command Mode	1319
Applicability	1319
Example	1319
show mac access-lists	1320
Command Syntax	1320
Parameters	1320
Default	1320
Command Mode	1320
Applicability	1320

Example	1320
show running-config access-list	1321
Command Syntax	1321
Parameters	1321
Default	1321
Command Mode	1321
Applicability	1321
Example	1321
show running-config aclmgr	1322
Command Syntax	1322
Parameters	1322
Default	1322
Command Mode	1322
Applicability	1322
Example	1322
show running-config ipv6 access-list	1323
Command Syntax	1323
Parameters	1323
Default	1323
Command Mode	1323
Applicability	1323
Example	1323
Access Control List Commands (Standard)	1324
ip access-list standard	1325
Command Syntax	1325
Parameter	1325
Default	1325
Command Mode	1325
Applicability	1325
Examples	1325
ip access-list standard filter	1326
Command Syntax	1326
Parameter	1326
Default	1326
Command Mode	1326
Applicability	1326
Examples	1326
Ipv6 access-list standard	1327
Command Syntax	1327
Parameter	1327
Default	1327
Command Mode	1327
Applicability	1327
Examples	1327
ipv6 access-list standard filter	1328
Command Syntax	1328
Parameters	1328

Default	1328
Command Mode	1328
Applicability	1328
Examples	1328
DHCP Snooping Commands	1329
debug ip dhcp snooping	1330
Command Syntax	1330
Parameters	1330
Default	1330
Command Mode	1330
Applicability	1330
Example	1330
ip dhcp snooping arp-inspection validate	1331
Command Syntax	1331
Parameters	1331
Default	1331
Command Mode	1331
Applicability	1331
Examples	1331
ip dhcp snooping binding bridge	1333
Command Syntax	1333
Parameters	1333
Default	1333
Command Mode	1333
Applicability	1333
Example	1333
ip dhcp snooping database	1335
Command Syntax	1335
Parameters	1335
Default	1335
Command Mode	1335
Applicability	1335
Example	1335
renew ip dhcp snooping binding database	1336
Command Syntax	1336
Parameters	1336
Default	1336
Command Mode	1336
Applicability	1336
Example	1336
show debugging ip dhcp snooping	1337
Command Syntax	1337
Parameters	1337
Command Mode	1337
Applicability	1337
Example	1337
show ip dhcp snooping arp-inspection statistics bridge	1338

Command Syntax	1338
Parameters	1338
Command Mode	1338
Applicability	1338
Examples	1338
show ip dhcp snooping bridge	1339
Command Syntax	1339
Parameters	1339
Command Mode	1339
Applicability	1339
Example	1339
show ip dhcp snooping binding bridge	1341
Command Syntax	1341
Parameters	1341
Command Mode	1341
Applicability	1341
Example	1341
IP Source Guard Commands	1343
hardware-profile filter ipsg	1344
Command Syntax	1344
Parameters	1344
Default	1344
Command Mode	1344
Applicability	1344
Examples	1344
hardware-profile filter ipsg-ipv6	1345
Command Syntax	1345
Parameters	1345
Default	1345
Command Mode	1345
Applicability	1345
Examples	1345
ip verify source dhcp-snooping-vlan	1346
Command Syntax	1346
Parameters	1346
Default	1346
Command Mode	1346
Applicability	1346
Examples	1346
Internet Protocol Security Commands	1347
crypto ipsec transform-set	1348
Command Syntax	1348
Parameters	1348
Command Mode	1349
Applicability	1349
Example	1350
crypto map	1351

Command Syntax	1351
Parameters	1351
Command Mode	1351
Applicability	1351
Example	1351
mode	1352
Command Syntax	1352
Parameters	1352
Default	1352
Command Mode	1352
Applicability	1352
Example	1352
set peer	1353
Command syntax	1353
Parameters	1353
Default	1353
Command Mode	1353
Applicability	1353
Examples	1353
set session-key	1354
Command syntax	1354
Parameters	1354
Default	1354
Command Mode	1354
Applicability	1354
Examples	1354
set transform-set	1356
Command syntax	1356
Parameters	1356
Default	1356
Command Mode	1356
Applicability	1356
Examples	1356
sequence	1357
Command syntax	1357
Parameters	1357
Default	1357
Command Mode	1357
Applicability	1357
Examples	1357
show crypto ipsec transform-set	1358
Command syntax	1358
Parameters	1358
Default	1358
Command Mode	1358
Applicability	1358
Examples	1358

System Management Configuration	1359
LAG with RTAG7 Hashing	1360
Overview	1360
Topology	1360
Dynamic LAG with RTAG7	1360
SW1	1360
SW2	1361
Static LAG with RTAG7	1362
SW1	1362
SW2	1363
System Management Command Reference	1365
Basic Commands	1372
banner motd	1374
Command Syntax	1374
Parameters	1374
Default	1374
Command Mode	1374
Applicability	1374
Examples	1374
cli timestamp	1375
Command Syntax	1375
Parameters	1375
Default	1375
Command Mode	1375
Applicability	1375
Example	1375
Validation Example	1375
clock set	1376
Command Syntax	1376
Parameters	1376
Default	1376
Command Mode	1376
Applicability	1376
Examples	1376
clock timezone	1377
Command Syntax	1377
Parameters	1377
Default	1377
Command Mode	1377
Applicability	1377
Examples	1377
configure terminal	1378
Command Syntax	1378
Parameters	1378
Default	1378
Command Mode	1378

Applicability	1378
Example	1378
configure terminal force	1379
Command Syntax	1379
Parameters	1379
Default	1379
Command Mode	1379
Applicability	1379
Example	1379
copy empty-config startup-config	1380
Command Syntax	1380
Parameters	1380
Default	1380
Command Mode	1380
Applicability	1380
Example	1380
copy running-config startup-config	1381
Command Syntax	1381
Parameters	1381
Default	1381
Command Mode	1381
Applicability	1381
Example	1381
crypto pki generate rsa common-name ipv4	1382
Command Syntax	1382
Parameters	1382
Default	1382
Command Mode	1382
Applicability	1382
Examples	1382
debug nsm	1383
Command Syntax	1383
Parameters	1383
Default	1383
Command Mode	1383
Applicability	1384
Examples	1384
debug vm-events	1385
Command Syntax	1385
Parameters	1385
Default	1385
Command Mode	1385
Applicability	1385
Examples	1385
disable	1386
Command Syntax	1386
Parameters	1386

Default	1386
Command Mode	1386
Applicability	1386
Example	1386
do	1387
Command Syntax	1387
Parameters	1387
Default	1387
Command Mode	1387
Applicability	1387
Example	1387
enable	1388
Command Syntax	1388
Parameters	1388
Default	1388
Command Mode	1388
Applicability	1388
Example	1388
enable password	1389
Command Syntax	1389
Parameters	1389
Default	1389
Command Mode	1389
Applicability	1389
Examples	1389
end	1390
Command Syntax	1390
Parameters	1390
Default	1390
Command Mode	1390
Applicability	1390
Example	1390
exec-timeout	1391
Command Syntax	1391
Parameters	1391
Default	1391
Command Mode	1391
Applicability	1391
Example	1391
exit	1392
Command Syntax	1392
Parameters	1392
Default	1392
Command Mode	1392
Applicability	1392
Examples	1392
help	1393

Command Syntax	1393
Parameters	1393
Default	1393
Command Mode	1393
Applicability	1393
Example	1393
history	1394
Command Syntax	1394
Parameters	1394
Default	1394
Command Mode	1394
Applicability	1394
Examples	1394
hostname	1395
Command Syntax	1395
Parameter	1395
Default	1395
Command Mode	1395
Applicability	1395
Example	1395
line console	1396
Command Syntax	1396
Parameters	1396
Default	1396
Command Mode	1396
Applicability	1396
Example	1396
line vty (all line mode)	1397
Command Syntax	1397
Parameters	1397
Default	1397
Command Mode	1397
Applicability	1397
Example	1397
line vty (line mode)	1398
Command Syntax	1398
Parameters	1398
Default	1398
Command Mode	1398
Applicability	1398
Example	1398
logging cli	1399
Command Syntax	1399
Parameters	1399
Default	1399
Command Mode	1399
Applicability	1399

Example	1399
logout	1400
Command Syntax	1400
Parameters	1400
Default	1400
Command Mode	1400
Applicability	1400
Example	1400
max-session	1401
Command syntax	1401
Parameters	1401
Default	1401
Command Mode	1401
Applicability	1401
Example	1401
ping	1402
Command Syntax	1402
Parameters	1402
Default	1403
Command Mode	1403
Applicability	1403
Examples	1403
ping (interactive)	1405
Command Syntax	1405
Parameters	1405
Default	1405
Command Mode	1405
Applicability	1405
Examples	1405
port breakout	1407
Command Syntax	1407
Parameters	1407
Default	1408
Command Mode	1408
Applicability	1408
Examples	1408
quit	1409
Command Syntax	1409
Parameters	1409
Default	1409
Command Mode	1409
Applicability	1409
Examples	1409
reload	1410
Command Syntax	1410
Parameters	1410
Default	1410

Command Mode	1410
Applicability	1410
Examples	1410
service advanced-vty	1411
Command Syntax	1411
Parameters	1411
Default	1411
Command Mode	1411
Applicability	1411
Examples	1411
service password-encryption	1412
Command Syntax	1412
Parameters	1412
Default	1412
Command Mode	1412
Applicability	1412
Example	1412
service terminal-length	1413
Command Syntax	1413
Parameters	1413
Default	1413
Command Mode	1413
Applicability	1413
Example	1413
show clock	1414
Command Syntax	1414
Parameters	1414
Command Mode	1414
Applicability	1414
Examples	1414
show cli	1415
Command Syntax	1415
Parameters	1415
Default	1415
Command Mode	1415
Applicability	1415
Example	1415
show cli history	1416
Command Syntax	1416
Command Mode	1416
Applicability	1416
Examples	1416
show cli list	1417
Command Syntax	1417
Parameters	1417
Default	1417
Command Mode	1417

Applicability	1417
Examples	1417
show cli list all	1418
Command Syntax	1418
Parameters	1418
Default	1418
Command Mode	1418
Applicability	1418
Example	1418
show cli modes	1420
Command Syntax	1420
Parameters	1420
Default	1420
Command Mode	1420
Applicability	1420
Examples	1420
show crypto csr	1422
Command Syntax	1422
Parameters	1422
Default	1422
Command Mode	1422
Applicability	1422
Example	1422
show debugging nsm	1423
Command Syntax	1423
Parameters	1423
Default	1423
Command Mode	1423
Applicability	1423
Examples	1423
show debugging vm-events	1424
Command Syntax	1424
Parameters	1424
Default	1424
Command Mode	1424
Applicability	1424
Examples	1424
show logging cli	1425
Command Syntax	1425
Parameters	1425
Default	1425
Command Mode	1425
Applicability	1425
Example	1425
show nsm client	1426
Command Syntax	1426
Parameters	1426

Default	1426
Command Mode	1426
Applicability	1426
Examples	1426
show process	1427
Command Syntax	1427
Parameters	1427
Command Mode	1427
Applicability	1427
Examples	1427
show running-config	1428
Command Syntax	1428
Parameters	1428
Command Mode	1428
Applicability	1428
Examples	1428
show running-config switch	1429
Command Syntax	1429
Parameters	1429
Default	1429
Command Mode	1429
Applicability	1429
Example	1430
show startup-config	1431
Command Syntax	1431
Parameters	1431
Default	1431
Command Mode	1431
Applicability	1431
Examples	1431
show tcp	1432
Command Syntax	1432
Parameters	1432
Command Mode	1432
Applicability	1432
Examples	1432
show timezone	1434
Command Syntax	1434
Parameters	1434
Default	1435
Command Mode	1435
Applicability	1435
Examples	1435
show users	1437
Command Syntax	1437
Parameters	1437
Command Mode	1437

Applicability	1437
Example	1437
show version	1439
Command Syntax	1439
Parameters	1439
Default	1439
Command Mode	1439
Applicability	1439
Examples	1439
sys-reload	1441
Command Syntax	1441
Parameters	1441
Default	1441
Command Mode	1441
Applicability	1441
Examples	1441
sys-shutdown	1442
Command Syntax	1442
Parameters	1442
Default	1442
Command Mode	1442
Applicability	1442
Examples	1442
terminal width	1443
Command Syntax	1443
Parameters	1443
Default	1443
Command Mode	1443
Applicability	1443
Examples	1443
terminal length	1444
Command Syntax	1444
Parameters	1444
Default	1444
Command Mode	1444
Applicability	1444
Examples	1444
terminal monitor	1445
Command Syntax	1445
Parameters	1445
Default	1445
Command Mode	1445
Applicability	1445
Examples	1445
terminal monitor default	1446
Command Syntax	1446
Parameters	1446

Default	1446
Command Mode	1446
Applicability	1446
Examples	1446
terminal timestamping	1447
Command Syntax	1447
Command Mode	1447
Applicability	1447
Examples	1447
terminal default timestamping	1447
Command Syntax	1447
Command Mode	1448
Applicability	1448
Examples	1448
traceroute	1449
Command Syntax	1449
Parameters	1449
Default	1449
Command Mode	1449
Applicability	1449
Examples	1449
watch static-mac-movement	1450
Command Syntax	1450
Command Syntax	1450
Default	1450
Command Mode	1450
Applicability	1450
Examples	1450
write	1451
Command Syntax	1451
Parameters	1451
Default	1451
Command Mode	1451
Applicability	1451
Examples	1451
write terminal	1452
Command Syntax	1452
Parameters	1452
Default	1452
Command Mode	1452
Applicability	1452
Example	1452
Multi-Line Banner Support	1453
Overview	1453
Options to Configure Multi-Banner Message	1453
Multi-Banner Message Command	1453
banner motd file URL	1453

Command Syntax	1454
Parameters	1454
Default	1454
Command Mode	1454
Applicability	1454
Examples	1455
Common Management Layer Commands	1456
abort transaction	1458
Command Syntax	1458
Parameters	1458
Default	1458
Command Mode	1458
Applicability	1458
Examples	1458
cancel-commit (WORD)	1459
Command Syntax	1459
Parameters	1459
Default	1459
Command Mode	1459
Applicability	1459
Example	1459
clear cml commit-history (WORD)	1462
Command Syntax	1462
Parameters	1462
Default	1462
Command Mode	1462
Applicability	1462
Example	1462
cml auto-config-sync	1463
Command Syntax	1463
Parameters	1463
Default	1463
Config Mode	1463
Applicability	1463
Example	1463
cml bulk-config	1464
Command Syntax	1464
Parameters	1464
Default	1464
Config Mode	1464
Applicability	1464
Example	1464
cml commit-history	1465
Command Syntax	1465
Parameters	1465
Default	1465
Command Mode	1465

Applicability	1465
Examples	1465
cml commit-id rollover	1467
Command Syntax	1467
Parameters	1467
Default	1467
Command Mode	1467
Applicability	1467
Example	1467
cml config-sync check	1468
Command Syntax	1468
Parameters	1468
Default	1468
Config Mode	1468
Applicability	1468
Example	1468
cml force-unlock config-datastore	1469
Command Syntax	1469
Parameters	1469
Default	1469
Command Mode	1469
Applicability	1469
Example	1469
cml lock config-datastore	1470
Command Syntax	1470
Parameters	1470
Default	1470
Command Mode	1470
Applicability	1470
Example	1470
cml logging	1472
Command Syntax	1472
Parameters	1472
Default	1472
Command Mode	1472
Applicability	1472
Example	1472
cml netconf translation	1473
Command Syntax	1473
Parameters	1473
Default	1473
Command Mode	1473
Applicability	1473
cml notification	1474
Command Syntax	1474
Parameters	1474
Default	1474

Command Mode	1474
Applicability	1474
Example	1474
cml unlock config-datastore	1475
Command Syntax	1475
Parameters	1475
Default	1475
Command Mode	1475
Applicability	1475
Example	1475
cmlsh cli-format	1476
Command Syntax	1476
Parameters	1476
Default	1476
Command Mode	1476
Applicability	1476
Example	1476
cmlsh multiple-config-session	1477
Command Syntax	1477
Parameters	1477
Default	1477
Command Mode	1477
Applicability	1477
Example	1477
Usage	1477
cmlsh notification	1479
Command Syntax	1479
Parameters	1479
Default	1479
Command Mode	1479
Applicability	1479
Example	1479
cmlsh transaction	1480
Command Syntax	1480
Parameters	1480
Default	1480
Command Mode	1480
Applicability	1480
Example	1480
cmlsh transaction limit	1481
Command Syntax	1481
Parameters	1481
Default	1481
Command Mode	1481
Applicability	1481
Example	1481
commit	1482

Command Syntax	1482
Parameters	1482
Default	1482
Command Mode	1483
Applicability	1483
Example	1483
Usage	1483
confirm-commit (WORD)	1484
Command Syntax	1484
Parameters	1484
Default	1484
Command Mode	1485
Applicability	1485
Example	1485
commit dry-run	1488
Command Syntax	1488
Parameters	1488
Default	1488
Command Mode	1488
Applicability	1488
Example	1488
commit-rollback	1489
Command Syntax	1489
Parameters	1489
Command Mode	1489
Applicability	1489
Example	1489
debug cml	1491
Command Syntax	1491
Parameters	1491
Default	1491
Command Mode	1491
Applicability	1491
Example	1491
module notification	1492
Command Syntax	1492
Parameters	1492
Command Mode	1492
Applicability	1492
Example	1492
netconf translation openconfig	1494
Command Syntax	1494
Parameters	1494
Default	1494
Command Mode	1494
Applicability	1494
Example	1494

save cml commit-history WORD	1495
Prerequisites	1495
Command Syntax	1495
Parameters	1495
Default	1495
Command Mode	1495
Applicability	1495
Example	1495
show cml auto-config-sync state	1497
Command Syntax	1497
Parameters	1497
Default	1497
Command Mode	1497
Applicability	1497
Example	1497
show cml bulk limit cpu state	1498
Command Syntax	1498
Parameters	1498
Default	1498
Command Mode	1498
Applicability	1498
Example	1498
show cml cli-error status	1499
Command Syntax	1499
Parameters	1499
Default	1499
Command Mode	1499
Applicability	1499
Example	1499
show cml commit-history state	1500
Command Syntax	1500
Parameters	1500
Default	1500
Command Mode	1500
Applicability	1500
Example	1500
show cml commit-id rollover state	1501
Command Syntax	1501
Parameters	1501
Default	1501
Command Mode	1501
Applicability	1501
Example	1501
show cml config-sync detail	1502
Command Syntax	1502
Parameters	1502
Default	1502

Command Mode	1502
Applicability	1502
Example	1502
show cml database-dump	1503
Command Syntax	1503
Parameters	1503
Default	1503
Command Mode	1503
Applicability	1503
Example	1503
show cml config-datastore lock status	1504
Command Syntax	1504
Parameters	1504
Default	1504
Command Mode	1504
Applicability	1504
Example	1504
show cml notification status	1505
Command Syntax	1505
Parameters	1505
Command Mode	1505
Applicability	1505
Example	1505
show cmlsh multiple-config-session status	1506
Command Syntax	1506
Parameters	1506
Default	1506
Command Mode	1506
Applicability	1506
Example	1506
show cmlsh notification status	1507
Command Syntax	1507
Parameters	1507
Command Mode	1507
Applicability	1507
Example	1507
show commit list	1507
Command Syntax	1507
Parameters	1507
Command Mode	1507
Applicability	1507
Example	1508
show json/xml commit config WORD	1509
Prerequisites	1509
Command Syntax	1509
Parameters	1509
Default	1509

Command Mode	1509
Applicability	1509
Example	1509
show json/xml commit diff WORD WORD	1510
Prerequisites	1510
Command Syntax	1510
Parameters	1510
Default	1510
Command Mode	1510
Applicability	1510
Example	1510
show max-transaction limit	1512
Command Syntax	1512
Parameters	1512
Default	1512
Command Mode	1512
Applicability	1512
Example	1512
show module-info	1513
Command Syntax	1513
Parameters	1513
Command Mode	1513
Applicability	1513
Example	1513
show running-config notification	1515
Command Syntax	1515
Parameters	1515
Command Mode	1515
Applicability	1515
Example	1515
show system restore failures	1516
Command Syntax	1516
Parameters	1516
Command Mode	1516
Applicability	1516
Example	1516
show transaction current	1517
Command Syntax	1517
Parameters	1517
Default	1517
Command Mode	1517
Applicability	1517
Example	1517
show transaction last-aborted	1518
Command Syntax	1518
Parameters	1518
Default	1518

Command Mode	1518
Applicability	1518
Example	1518
show xml/json OBJECT_NAME	1519
Command Syntax	1519
Parameters	1519
Command Mode	1519
Applicability	1519
Example	1519
Remote Management Commands	1522
copy running-config	1524
Command Syntax	1524
Parameters	1524
Command Mode	1524
Applicability	1524
Example	1524
copy running-config (interactive)	1525
Command Syntax	1525
Parameters	1525
Command Mode	1525
Applicability	1525
Example	1525
copy startup-config	1526
Command Syntax	1526
Parameters	1526
Command Mode	1526
Applicability	1526
Examples	1526
copy startup-config (interactive)	1527
Command Syntax	1527
Parameters	1527
Command Mode	1527
Applicability	1527
Examples	1527
copy system file	1528
Command Syntax	1528
Parameters	1528
Command Mode	1528
Applicability	1529
Examples	1529
copy system file (interactive)	1530
Command Syntax	1530
Parameters	1530
Command Mode	1531
Applicability	1531
Examples	1531
copy ftp startup-config	1532

Command Syntax	1532
Parameters	1532
Command Mode	1532
Applicability	1532
Examples	1532
copy scp filepath	1533
Command Syntax	1533
Parameters	1533
Command Mode	1533
Applicability	1533
Examples	1533
copy scp startup-config	1534
Command Syntax	1534
Parameters	1534
Command Mode	1534
Applicability	1534
Examples	1534
copy sftp startup-config	1535
Command Syntax	1535
Parameters	1535
Command Mode	1535
Applicability	1535
Examples	1535
copy tftp startup-config	1536
Command Syntax	1536
Parameters	1536
Command Mode	1536
Applicability	1536
Examples	1536
copy http startup-config	1537
Command Syntax	1537
Parameters	1537
Command Mode	1537
Applicability	1537
Examples	1537
copy ftp startup-config (interactive)	1538
Command Syntax	1538
Parameters	1538
Default	1538
Command Mode	1538
Applicability	1538
Example	1538
copy scp startup-config (interactive)	1539
Command Syntax	1539
Parameters	1539
Default	1539
Command Mode	1539

Applicability	1539
Examples	1539
copy sftp startup-config (interactive)	1540
Command Syntax	1540
Parameters	1540
Default	1540
Command Mode	1540
Applicability	1540
Examples	1540
copy tftp startup-config (interactive)	1541
Command Syntax	1541
Parameters	1541
Default	1541
Command Mode	1541
Applicability	1541
Examples	1541
copy http startup-config (interactive)	1542
Command Syntax	1542
Parameters	1542
Default	1542
Command Mode	1542
Applicability	1542
Examples	1542
copy file startup-config	1543
Command Syntax	1543
Parameters	1543
Default	1543
Command Mode	1543
Applicability	1543
Examples	1543
load-config	1544
Command Syntax	1544
Parameters	1544
Default	1544
Command Mode	1544
Applicability	1544
Example	1544
Interface Commands	1545
admin-group	1548
Command Syntax	1548
Parameters	1548
Default	1548
Command Mode	1548
Applicability	1548
Example	1548
bandwidth	1549
Command Syntax	1549

Parameters	1549
Default	1549
Command Mode	1549
Applicability	1549
Example	1549
bandwidth-measurement static uni-available-bandwidth	1550
Command Syntax	1550
Parameters	1550
Command Mode	1550
Applicability	1550
Examples	1550
bandwidth-measurement static uni-residual-bandwidth	1551
Command Syntax	1551
Parameters	1551
Command Mode	1551
Applicability	1551
Examples	1551
bandwidth-measurement static uni-utilized-bandwidth	1552
Command Syntax	1552
Parameters	1552
Command Mode	1552
Applicability	1552
Examples	1552
clear hardware-discard-counters	1553
Command Syntax	1553
Parameters	1553
Default	1553
Command Mode	1553
Applicability	1553
Examples	1553
clear interface counters	1554
Command Syntax	1554
Parameters	1554
Command Mode	1554
Applicability	1554
Example	1554
clear interface cpu counters	1555
Command Syntax	1555
Parameters	1555
Default	1555
Command Mode	1555
Applicability	1555
Example	1555
clear interface fec	1556
Command Syntax	1556
Parameter	1556
Default	1556

Command Mode	1556
Applicability	1556
Example	1556
clear ip prefix-list	1557
Command Syntax	1557
Parameters	1557
Default	1557
Command Mode	1557
Applicability	1557
Example	1557
clear ipv6 neighbors	1558
Command Syntax	1558
Parameters	1558
Default	1558
Command Mode	1558
Applicability	1558
Example	1558
clear ipv6 prefix-list	1559
Command Syntax	1559
Parameters	1559
Default	1559
Command Mode	1559
Applicability	1559
Example	1559
debounce-time	1560
Command Syntax	1560
Parameters	1560
Default	1560
Command Mode	1560
Applicability	1560
Example	1561
delay-measurement dynamic twamp	1562
Command Syntax	1562
Parameters	1562
Default	1563
Command Mode	1563
Applicability	1563
Example	1563
delay-measurement a-bit-min-max-delay-threshold	1564
Command Syntax	1564
Parameters	1564
Default	1564
Command Mode	1564
Applicability	1564
Examples	1564
delay-measurement static	1565
Command Syntax	1565

Parameters	1565
Default	1565
Command Mode	1565
Applicability	1565
Examples	1565
delay-measurement a-bit-delay-threshold	1567
Command Syntax	1567
Parameters	1567
Default	1567
Command Mode	1567
Applicability	1567
Examples	1567
default-interface l2protocol	1567
Command Syntax	1568
Parameter	1568
Default	1568
Command Mode	1568
Applicability	1568
Example	1568
default-interface load-interval	1569
Command Syntax	1569
Parameter	1569
Default	1569
Command Mode	1569
Applicability	1569
Example	1569
default-interface type mtu	1569
Command Syntax	1569
Parameter	1570
Default	1570
Command Mode	1570
Applicability	1570
Example	1570
description	1571
Command Syntax	1571
Parameter	1571
Default	1571
Command Mode	1571
Applicability	1571
Examples	1571
duplex	1572
Command Syntax	1572
Parameters	1572
Default	1572
Command Mode	1572
Applicability	1572
Examples	1572

fec	1573
Command Syntax	1573
Parameters	1573
Default	1573
Command Mode	1573
Applicability	1573
Examples	1574
flowcontrol	1575
Command Syntax	1575
Parameters	1575
Default	1575
Command Mode	1575
Applicability	1575
Examples	1575
hardware-profile portmode	1577
Command Syntax	1577
Parameters	1577
Default	1577
Command Mode	1577
Applicability	1577
Examples	1577
if-arbiter	1578
Command Syntax	1578
Parameters	1578
Default	1578
Command Mode	1578
Applicability	1578
Example	1578
interface	1579
Command Syntax	1579
Parameter	1579
Default	1579
Command Mode	1579
Applicability	1579
Example	1579
ip address A.B.C.D/M	1580
Command Syntax	1580
Parameters	1580
Default	1580
Command Mode	1580
Applicability	1580
Examples	1580
ip address dhcp	1581
Command Syntax	1581
Parameters	1581
Default	1581
Command Mode	1581

Applicability	1581
Examples	1581
ip forwarding	1582
Command Syntax	1582
Parameters	1582
Default	1582
Command Mode	1582
Applicability	1582
Examples	1582
ip prefix-list	1583
Command Syntax	1583
Parameters	1583
Default	1584
Command Mode	1584
Applicability	1584
Examples	1584
ip proxy-arp	1585
Command Syntax	1585
Parameters	1585
Default	1585
Command Mode	1585
Applicability	1585
Example	1585
ip remote-address	1586
Command Syntax	1586
Command Syntax	1586
Default	1586
Command Mode	1586
Applicability	1586
Example	1586
ip unnumbered	1587
Command Syntax	1587
Parameters	1587
Command Mode	1587
Applicability	1587
Examples	1587
ip vrf forwarding	1588
Command Syntax	1588
Parameters	1588
Default	1588
Command Mode	1588
Applicability	1588
Example	1588
ipv6 address	1589
Command Syntax	1589
Parameters	1589
Default	1589

Command Mode	1589
Applicability	1589
Examples	1589
ipv6 forwarding	1590
Command Syntax	1590
Parameters	1590
Default	1590
Command Mode	1590
Applicability	1590
Example	1590
ipv6 prefix-list	1591
Command Syntax	1591
Parameters	1591
Default	1592
Command Mode	1592
Applicability	1592
Examples	1592
ipv6 unnumbered	1593
Command Syntax	1593
Parameters	1593
Default	1593
Command Mode	1593
Applicability	1593
Example	1593
link-debounce-time	1594
Command Syntax	1594
Parameters	1594
Default	1594
Command Mode	1594
Applicability	1594
Example	1594
load interval	1595
Command Syntax	1595
Parameters	1595
Default	1595
Command Mode	1595
Applicability	1595
Example	1595
loopback	1596
Command Syntax	1596
Parameters	1596
Default	1596
Command Mode	1596
Applicability	1596
Example	1596
loss-measurement dynamic	1597
Command Syntax	1597

Parameters	1597
Default	1597
Command Mode	1597
Applicability	1597
Example	1597
loss-measurement uni-link-loss	1598
Command Syntax	1598
Parameters	1598
Default	1598
Command Mode	1598
Applicability	1598
Examples	1598
mac-address	1599
Command Syntax	1599
Parameters	1599
Default	1599
Command mode	1599
Applicability	1599
Examples	1599
monitor speed	1600
Command Syntax	1600
Parameters	1600
Default	1600
Command Mode	1600
Applicability	1600
Example	1600
monitor queue-drops	1601
Command Syntax	1601
Parameters	1601
Default	1601
Command Mode	1601
Applicability	1601
Example	1601
monitor speed threshold	1602
Command Syntax	1602
Parameters	1602
Default	1602
Command Mode	1602
Applicability	1602
Example	1602
mtu	1603
Limitation for MTU configuration on Label-Switching	1603
Command Syntax	1603
Parameters	1603
Default	1603
Command Mode	1604
Applicability	1604

Example	1604
multicast	1605
Command Syntax	1605
Parameters	1605
Default	1605
Command Mode	1605
Applicability	1605
Example	1605
show flowcontrol	1606
Command Syntax	1606
Parameters	1606
Default	1606
Command Mode	1606
Applicability	1606
Example	1606
show hardware-discard-counters	1608
Command Syntax	1608
Parameters	1608
Default	1608
Command Mode	1608
Applicability	1608
Examples	1608
show interface	1610
Command Syntax	1610
Parameters	1610
Default	1610
Command Mode	1610
Applicability	1610
Example	1610
show interface capabilities	1613
Command Syntax	1613
Parameters	1613
Default	1613
Command Mode	1613
Applicability	1613
Example	1613
show interface counters	1615
Command Syntax	1615
Parameters	1615
Command Mode	1615
Applicability	1615
Example	1615
show interface counters drop-stats	1618
Command Syntax	1618
Parameters	1618
Default	1618
Command Mode	1618

Applicability	1618
Example	1618
show interface counters error-stats	1621
Command Syntax	1621
Parameters	1621
Default	1621
Command Mode	1621
Applicability	1621
Example	1621
show interface counters (indiscard-stats outdiscard-stats)	1623
Command Syntax	1623
Parameters	1623
Default	1623
Command Mode	1623
Applicability	1623
Examples	1623
show interface counters protocol	1626
Command Syntax	1626
Parameters	1626
Default	1626
Command Mode	1626
Applicability	1626
Example	1626
show interface counters queue-drop-stats	1627
Command Syntax	1627
Parameters	1627
Default	1627
Command Mode	1627
Applicability	1627
Example	1627
show interface counters queue-stats	1628
Command Syntax	1628
Parameters	1628
Default	1628
Command Mode	1628
Applicability	1628
Example	1628
show interface counters rate	1630
Command Syntax	1630
Parameters	1630
Default	1630
Command Mode	1630
Applicability	1630
Example	1630
show interface counters speed	1632
Command Syntax	1632
Parameters	1632

Default	1632
Command Mode	1632
Applicability	1632
Example	1632
show interface counters summary	1633
Command Syntax	1633
Parameters	1633
Default	1633
Command Mode	1633
Applicability	1633
Example	1633
show interface fec	1635
Command Syntax	1635
Parameters	1635
Default	1635
Command Mode	1635
Applicability	1635
Example	1635
show ip forwarding	1637
Command Syntax	1637
Parameters	1637
Default	1637
Command Mode	1637
Applicability	1637
Example	1637
show ip interface	1638
Command Syntax	1638
Parameters	1638
Default	1638
Command Mode	1638
Applicability	1638
Example	1638
show ip prefix-list	1640
Command Syntax	1640
Parameters	1640
Default	1640
Command Mode	1640
Applicability	1640
Example	1640
show ip route	1642
Command Syntax	1642
Parameters	1642
Default	1643
Command Mode	1643
Applicability	1643
Example	1643
show ip route A.B.C.D/M longer-prefixes	1644

Command Syntax	1644
Parameters	1644
Default	1644
Command Mode	1644
Applicability	1644
Example	1644
show ip vrf	1652
Command Syntax	1652
Parameters	1652
Default	1652
Command Mode	1652
Applicability	1652
Example	1652
show ipv6 forwarding	1653
Command Syntax	1653
Parameters	1653
Default	1653
Command Mode	1653
Applicability	1653
Example	1653
show ipv6 interface brief	1654
Command Syntax	1654
Parameters	1654
Default	1654
Command Mode	1654
Applicability	1654
Example	1654
show ipv6 route	1656
Command Syntax	1656
Parameters	1656
Default	1657
Command Mode	1657
Applicability	1657
Examples	1657
show ipv6 prefix-list	1658
Command Syntax	1658
Parameters	1658
Default	1658
Command Mode	1658
Applicability	1658
Example	1658
show hosts	1660
Command Syntax	1660
Parameters	1660
Default	1660
Command Mode	1660
Applicability	1660

Example	1660
show running-config interface	1662
Command Syntax	1662
Parameter	1662
Default	1663
Command Mode	1663
Applicability	1663
Example	1663
show running-config interface ip	1664
Command Syntax	1664
Parameters	1664
Default	1664
Command Mode	1664
Applicability	1664
Example	1664
show running-config interface ipv6	1665
Command Syntax	1665
Parameters	1665
Default	1665
Command Mode	1665
Applicability	1665
Example	1665
show running-config ip	1666
Command Syntax	1666
Parameters	1666
Default	1666
Command Mode	1666
Applicability	1666
Example	1666
show running-config ipv6	1667
Command Syntax	1667
Parameters	1667
Default	1667
Command Mode	1667
Applicability	1667
Example	1667
show running-config prefix-list	1668
Command Syntax	1668
Parameters	1668
Default	1668
Command Mode	1668
Applicability	1668
Example	1668
shutdown	1669
Command Syntax	1669
Parameters	1669
Default	1669

Command Mode	1669
Applicability	1669
Examples	1669
speed	1670
Command Syntax	1671
Parameters	1671
Default	1672
Command Mode	1672
Applicability	1672
Example	1672
switchport	1673
Command Syntax	1673
Parameters	1673
Default	1673
Command Mode	1673
Applicability	1673
Examples	1673
switchport allowed ethertype	1675
Command Syntax	1675
Parameters	1675
Default	1675
Command Mode	1675
Applicability	1675
Example	1675
switchport protected	1676
Command Syntax	1676
Parameters	1676
Default	1676
Command Mode	1676
Applicability	1676
Example	1676
transceiver	1677
Command Syntax	1677
Parameters	1677
Default	1678
Command Mode	1678
Applicability	1678
Examples	1678
tx cdr-bypass	1679
Command Syntax	1679
Parameters	1679
Default	1679
Command Mode	1679
Applicability	1679
Examples	1679
rx cdr-bypass	1680
Command Syntax	1680

Parameters	1680
Default	1680
Command Mode	1680
Applicability	1680
Examples	1680
Time Range Commands	1681
end-time (absolute)	1682
Command Syntax	1682
Parameters	1682
Default	1682
Command Mode	1683
Applicability	1683
Example	1683
end-time after (relative)	1684
Command Syntax	1684
Parameters	1684
Default	1684
Command Mode	1684
Applicability	1684
Example	1684
frequency	1685
Command Syntax	1685
Parameters	1685
Default	1685
Command Mode	1685
Applicability	1685
Example	1685
frequency days (specific days)	1686
Command Syntax	1686
Parameters	1686
Default	1686
Command Mode	1686
Applicability	1686
Example	1686
start-time (absolute)	1687
Command Syntax	1687
Parameters	1687
Default	1687
Command Mode	1688
Applicability	1688
Example	1688
start-time after (relative)	1689
Command Syntax	1689
Parameters	1689
Default	1689
Command Mode	1689
Applicability	1689

Example	1689
start-time now (current)	1690
Command Syntax	1690
Parameters	1690
Default	1690
Command Mode	1690
Applicability	1690
Example	1690
time-range	1691
Command Syntax	1691
Parameters	1691
Default	1691
Command Mode	1691
Applicability	1691
Example	1691
System Configure Mode Commands	1692
delay-profile interfaces	1693
Command Syntax	1693
Parameters	1693
Command Mode	1693
Applicability	1693
Examples	1693
delay-profile interfaces subcommands	1694
Command Syntax	1694
Parameters	1694
Command Mode	1694
Default	1695
Applicability	1695
Examples	1695
forwarding custom-profile	1696
Command Syntax	1696
Parameters	1696
Default	1697
Command Mode	1697
Applicability	1697
Examples	1697
forwarding profile	1698
Command Syntax	1698
Parameters	1698
Default	1698
Command Mode	1698
Applicability	1699
Examples	1699
ip redirects	1700
Command Syntax	1700
Parameters	1700
Default	1700

Command Mode	1700
Applicability	1700
Example	1700
load-balance enable	1701
Command Syntax	1701
Parameter	1701
Command Mode	1703
Applicability	1703
Examples	1703
hardware-profile filter (XGS)	1704
Command Syntax	1704
Parameter	1704
Default	1705
Command Mode	1705
Applicability	1705
Examples	1705
load-balance rtag7	1706
Command Syntax	1706
Parameters	1706
Command Mode	1708
Applicability	1708
Examples	1708
load-balance rtag7 all-lag-if	1708
Command Syntax	1708
Parameter	1708
Command Mode	1708
Applicability	1708
Examples	1708
load-balance rtag7 hash	1709
Command Syntax	1709
load-balance rtag7 macro-flow	1710
Command Syntax	1710
show forwarding profile limit	1711
Command Syntax	1711
Parameters	1711
Default	1711
Command Mode	1711
Applicability	1711
Examples	1711
show hardware-profile filters	1713
Command Syntax	1713
Parameters	1713
Default	1713
Command Mode	1713
Applicability	1713
Examples	1713
Linux Shell Commands	1715

Commit Rollback	1716
Overview	1716
Commit Rollback Characteristics	1716
Benefits	1716
Prerequisites	1716
show commit list	1716
Command Syntax	1717
Parameters	1717
Command Mode	1717
Applicability	1717
Example	1717
commit-rollback	1717
Command Syntax	1717
Parameter	1717
Command Mode	1718
Applicability	1718
Example	1718
clear cml commit-history (WORD)	1719
Command Syntax	1719
Parameters	1719
Default	1719
Command Mode	1719
Applicability	1719
Example	1719
cml commit-history	1720
Command Syntax	1720
Parameters	1720
Default	1720
Command Mode	1720
Applicability	1720
Examples	1720
cml commit-id rollover	1722
Command Syntax	1722
Parameters	1722
Default	1722
Command Mode	1722
Applicability	1722
Example	1722
Index	1723

PREFACE

About this Guide

This guide describes how to configure System Management in OcNOS.

IP Maestro Support

Monitor devices running OcNOS Release 6.3.4-70 and above using IP Maestro software.

Audience

This guide is intended for network administrators and other engineering professionals who configure OcNOS.

Conventions

The [Table 1](#) table shows the conventions used in this guide.

Table 1. Conventions

Convention	Description
Italics	Emphasized terms; titles of books
 Note:	Special instructions, suggestions, or warnings
<code>monospaced type</code>	Code elements such as commands, parameters, files, and directories

Chapter Organization

The chapters in command references are organized as described in [Command Description Format \(page 134\)](#).

The chapters in configuration guides are organized into these major sections:

- An overview that explains a configuration in words
- Topology with a diagram that shows the devices and connections used in the configuration
- Configuration steps in a table for each device where the left-hand side shows the commands you enter and the right-hand side explains the actions that the commands perform
- Validation which shows commands and their output that verify the configuration

Related Documentation

For information about installing OcNOS, see the *Installation Guide* for your platform.

Feature Availability

The features described in this document that are available depend upon the OcNOS SKU that you purchased. See the [Feature Matrix](#) for a description of the OcNOS SKUs.

Migration Guide

Check the *Migration Guide* for configuration changes to make when migrating from one version of OcNOS to another.

Support

For support-related questions, contact support@ipinfusion.com.

Comments

If you have comments, or need to report a problem with the content, contact techpubs@ipinfusion.com.

Command Line Interface

This chapter introduces the OcNOS Command Line Interface (CLI) and how to use its features.

Command Line Interface Help	130
Command Completion	131
Command Abbreviations	131
Command Line Errors	131
Syntax Conventions	132
Variable Placeholders	133
Command Description Format	134
Keyboard Operations	134
Show Command Modifiers	135
String Parameters	137
Command Modes	137
Transaction-based Command-line Interface	139

Command Line Interface Help

You access the CLI help by entering a full or partial command string and a question mark “?”. The CLI displays the command keywords or parameters along with a short description. For example, at the CLI command prompt, type:

```
> show ?
```

The CLI displays this keyword list with short descriptions for each keyword:

```
show ?
  application-priority      Application Priority
  arp                      Internet Protocol (IP)
  bfd                      Bidirectional Forwarding Detection (BFD)
  bgp                      Border Gateway Protocol (BGP)
  bi-lsp                   Bi-directional lsp status and configuration
  bridge                   Bridge group commands
  ce-vlan                  COS Preservation for Customer Edge VLAN
  class-map                Class map entry
  cli                     Show CLI tree of current mode
  clns                    Connectionless-Mode Network Service (CLNS)
  control-adjacency        Control Adjacency status and configuration
  control-channel          Control Channel status and configuration
  cspf                    CSPF Information
  customer                 Display Customer spanning-tree
  cvlan                   Display CVLAN information
  debugging                Debugging functions
  etherchannel             LACP etherchannel
  ethernet                 Layer-2
  ...
```

If you type the ? in the middle of a keyword, the CLI displays help for that keyword only.

```
> show de?
debugging Debugging functions
```

If you type the ? in the middle of a keyword, but the incomplete keyword matches several other keywords, OcNOS displays help for all matching keywords.

```
> show i? (CLI does not display the question mark).
interface  Interface status and configuration
ip         IP information
isis      ISIS information
```

Command Completion

The CLI can complete the spelling of a command or a parameter. Begin typing the command or parameter and then press the tab key. For example, at the CLI command prompt type **sh**:

```
> sh
```

Press the tab key. The CLI displays:

```
> show
```

If the spelling of a command or parameter is ambiguous, the CLI displays the choices that match the abbreviation. Type **show i** and press the tab key. The CLI displays:

```
> show i
interface ip      ipv6      isis
> show i
```

The CLI displays the **interface** and **ip** keywords. Type **n** to select **interface** and press the tab key. The CLI displays:

```
> show in
> show interface
```

Type **?** and the CLI displays the list of parameters for the **show interface** command.

```
> show interface
IFNAME  Interface name
|       Output modifiers
>       Output redirection
<cr>
```

The CLI displays the only parameter associated with this command, the **IFNAME** parameter.

Command Abbreviations

The CLI accepts abbreviations that uniquely identify a keyword in commands. For example:

```
> sh int xe0
```

is an abbreviation for:

```
> show interface xe0
```

Command Line Errors

Any unknown spelling causes the CLI to display the error **Unrecognized command** in response to the ?. The CLI displays the command again as last entered.

```
> show dd?
```

```
% Unrecognized command
> show dd
```

When you press the Enter key after typing an invalid command, the CLI displays:

```
(config)#router ospf here
                        ^
% Invalid input detected at '^' marker.
```

where the ^ points to the first character in error in the command.

If a command is incomplete, the CLI displays the following message:

```
> show
% Incomplete command.
```

Some commands are too long for the display line and can wrap mid-parameter or mid-keyword, as shown below. This does *not* cause an error and the command performs as expected:

```
area 10.10.0.18 virtual-link 10.10.0.19 authentication-key 57393
```

Command Negation

Many commands have a **no** form that resets a feature to its default value or disables the feature. For example:

- The **ip address** command assigns an IPv4 address to an interface
- The **no ip address** command removes an IPv4 address from an interface

Syntax Conventions

[Table 2](#) describes the conventions used to represent command syntax in this reference.

Table 2. Syntax conventions

Convention	Description	Example
monospaced font	Command strings entered on a command line	show ip ospf
lowercase	Keywords that you enter exactly as shown in the command syntax.	show ip ospf
UPPERCASE	See Variable Placeholders (page 133)	IFNAME
()	Optional parameters, from which you must select one. Vertical bars delimit the selections. Do not enter the parentheses or vertical bars as part of the command.	(A.B.C.D <0-4294967295>)
()	Optional parameters, from which you select one or none. Vertical bars delimit the selections. Do not enter the parentheses or vertical bars as part of the command.	(A.B.C.D <0-4294967295>)
()	Optional parameter which you can specify or omit. Do not enter the parentheses or vertical bar as part of the command.	(IFNAME)

Table 2. Syntax conventions (continued)

Convention	Description	Example
{ }	Optional parameters, from which you must select one or more. Vertical bars delimit the selections. Do not enter the braces or vertical bars as part of the command.	<code>{intra-area <1-255> inter-area <1-255> external <1-255>}</code>
[]	Optional parameters, from which you select zero or more. Vertical bars delimit the selections. Do not enter the brackets or vertical bars as part of the command.	<code>[<1-65535> AA:NN internet local-AS no-advertise no-export]</code>
?	Nonrepeatable parameter. The parameter that follows a question mark can only appear once in a command string. Do not enter the question mark as part of the command.	<code>?route-map WORD</code>
.	Repeatable parameter. The parameter that follows a period can be repeated more than once. Do not enter the period as part of the command.	<code>set as-path prepend .<1-65535></code>

Variable Placeholders

Table 3 shows the tokens used in command syntax use to represent variables for which you supply a value.

Table 3. Variable placeholders

Token	Description
WORD	A contiguous text string (excluding spaces)
LINE	A text string, including spaces; no other parameters can follow this parameter
IFNAME	Interface name whose format varies depending on the platform; examples are: eth0 , Ethernet0 , ethernet0 , xe0
A.B.C.D	IPv4 address
A.B.C.D/M	IPv4 address and mask/prefix
X:X::X:X	IPv6 address
X:X::X:X/M	IPv6 address and mask/prefix
HH:MM:SS	Time format
AA:NN	BGP community value
XX:XX:XX:XX:XX:XX	MAC address
<1-5> <1-65535> <0-2147483647> <0-4294967295>	Numeric range

Command Description Format

The [Table 4](#) table explains the sections used to describe each command in this reference.

Table 4. Command descriptions

Section	Description
Command Name	The name of the command, followed by what the command does and when should it be used
Command Syntax	The syntax of the command
Parameters	Parameters and options for the command
Default	The state before the command is executed
Command Mode	The mode in which the command runs; see Command Modes (page 137)
Example	An example of the command being executed

Keyboard Operations

The [Table 5](#) table lists the operations you can perform from the keyboard.

Table 5. Keyboard operations

Key combination	Operation
Left arrow or Ctrl+b	Moves one character to the left. When a command extends beyond a single line, you can press left arrow or Ctrl+b repeatedly to scroll toward the beginning of the line, or you can press Ctrl+a to go directly to the beginning of the line.
Right arrow or Ctrl-f	Moves one character to the right. When a command extends beyond a single line, you can press right arrow or Ctrl+f repeatedly to scroll toward the end of the line, or you can press Ctrl+e to go directly to the end of the line.
Esc, b	Moves back one word
Esc, f	Moves forward one word
Ctrl+e	Moves to end of the line
Ctrl+a	Moves to the beginning of the line
Ctrl+u	Deletes the line
Ctrl+w	Deletes from the cursor to the previous whitespace
Alt+d	Deletes the current word
Ctrl+k	Deletes from the cursor to the end of line
Ctrl+y	Pastes text previously deleted with Ctrl+k, Alt+d, Ctrl+w, or Ctrl+u at the cursor
Ctrl+t	Transposes the current character with the previous character
Ctrl+c	Ignores the current line and redisplay the command prompt
Ctrl+z	Ends configuration mode and returns to exec mode
Ctrl+l	Clears the screen

Table 5. Keyboard operations (continued)

Key combination	Operation
Up Arrow or Ctrl+p	Scroll backward through command history
Down Arrow or Ctrl+n	Scroll forward through command history

Show Command Modifiers

You can use two tokens to modify the output of a **show** command. Enter a question mark to display these tokens:

```
# show users ?
| Output modifiers
> Output redirection
```

You can type the | (vertical bar character) to use output modifiers. For example:

```
> show rsvp | ?
begin      Begin with the line that matches
exclude    Exclude lines that match
include    Include lines that match
last       Last few lines
redirect   Redirect output
```

Begin Modifier

The **begin** modifier displays the output beginning with the first line that contains the input string (everything typed after the **begin** keyword). For example:

```
# show running-config | begin xe1
...skipping
interface xe1
ipv6 address fe80::204:75ff:fee6:5393/64
!
interface xe2
ipv6 address fe80::20d:56ff:fe96:725a/64
!
line con 0
login
!
end
```

You can specify a regular expression after the **begin** keyword. This example begins the output at a line with either “xe2” or “xe4”:

```
# show running-config | begin xe[2-4]

...skipping
interface xe2
 shutdown
!
interface xe4
 shutdown
!
interface svlan0.1
 no shutdown
!
route-map myroute permit 2
!
route-map mymap1 permit 10
!
route-map rmap1 permit 2
```

```
!
line con 0
  login
line vty 0 4
  login
!
end
```

Include Modifier

The **include** modifier includes only those lines of output that contain the input string. In the output below, all lines containing the word “input” are included:

```
# show interface xe1 | include input
  input packets 80434552, bytes 2147483647, dropped 0, multicast packets 0
  input errors 0, length 0, overrun 0, CRC 0, frame 0, fifo 1, missed 0
```

You can specify a regular expression after the **include** keyword. This examples includes all lines with “input” or “output”:

```
#show interface xe0 | include (in|out)put
  input packets 597058, bytes 338081476, dropped 0, multicast packets 0
  input errors 0, length 0, overrun 0, CRC 0, frame 0, fifo 0, missed 0
  output packets 613147, bytes 126055987, dropped 0
  output errors 0, aborted 0, carrier 0, fifo 0, heartbeat 0, window 0
```

Exclude Modifier

The **exclude** modifier excludes all lines of output that contain the input string. In the following output example, all lines containing the word “input” are excluded:

```
# show interface xe1 | exclude input
Interface xe1
  Scope: both
  Hardware is Ethernet, address is 0004.75e6.5393
  index 3 metric 1 mtu 1500 <UP,BROADCAST,RUNNING,MULTICAST>
  VRF Binding: Not bound
  Administrative Group(s): None
  DSTE Bandwidth Constraint Mode is MAM
  inet6 fe80::204:75ff:fee6:5393/64
    output packets 4438, bytes 394940, dropped 0
    output errors 0, aborted 0, carrier 0, fifo 0, heartbeat 0, window 0
    collisions 0
```

You can specify a regular expression after the **exclude** keyword. This example excludes lines with “output” or “input”:

```
show interface xe0 | exclude (in|out)put
Interface xe0
  Scope: both
  Hardware is Ethernet Current HW addr: 001b.2139.6c4a
  Physical:001b.2139.6c4a Logical:(not set)
  index 2 metric 1 mtu 1500 duplex-full arp ageing timeout 3000
  <UP,BROADCAST,RUNNING,MULTICAST>
  VRF Binding: Not bound
  Bandwidth 100m
  DHCP client is disabled.
  inet 10.1.2.173/24 broadcast 10.1.2.255
  VRRP Master of : VRRP is not configured on this interface.
  inet6 fe80::21b:21ff:fe39:6c4a/64
    collisions 0
```

Redirect Modifier

The **redirect** modifier writes the output into a file. The output is not displayed.

```
# show cli history | redirect /var/frame.txt
```

The output redirection token (>) does the same thing:

```
# show cli history >/var/frame.txt
```

Last Modifier

The **last** modifier displays the output of last few number of lines (As per the user input). The last number ranges from 1 to 9999.

For example:

```
#show running-config | last 10
```

String Parameters

The restrictions in [Table 6](#) apply for all string parameters used in OcNOS commands, unless some other restrictions are noted for a particular command.

Table 6. String parameter restrictions

Restriction	Description
Input length	1965 characters or less
Restricted special characters	“?”, “”, “>”, “ ”, and “=” The “ ” character is allowed only for the description command in interface mode.

Command Modes

Commands are grouped into modes arranged in a hierarchy. Each mode has its own set of commands. The table below lists the command modes common to all protocols.

Table 7. Common Command Modes

Name	Description
Execution mode	Also called <i>view</i> mode, this is the first mode to appear after you start the CLI. It is a base mode from where you can perform basic commands such as show, exit, quit, help, and enable.
Privileged execution mode	Also called <i>enable</i> mode, in this mode you can run additional basic commands such as debug, write, and show.
Configure mode	Also called <i>configure terminal</i> mode, in this mode you can run configuration commands and go into other modes such as interface, router, route map, key chain, and address family. Configure mode is single user. Only one user at a time can be in configure mode.

Table 7. Common Command Modes (continued)

Name	Description
Interface mode	In this mode you can configure protocol-specific settings for a particular interface. Any setting you configure in this mode overrides a setting configured in router mode.
Router mode	This mode is used to configure router-specific settings for a protocol such as BGP or OSPF.

Command Mode Tree

The diagram below shows the common command mode hierarchy.

Figure 1. Common command modes

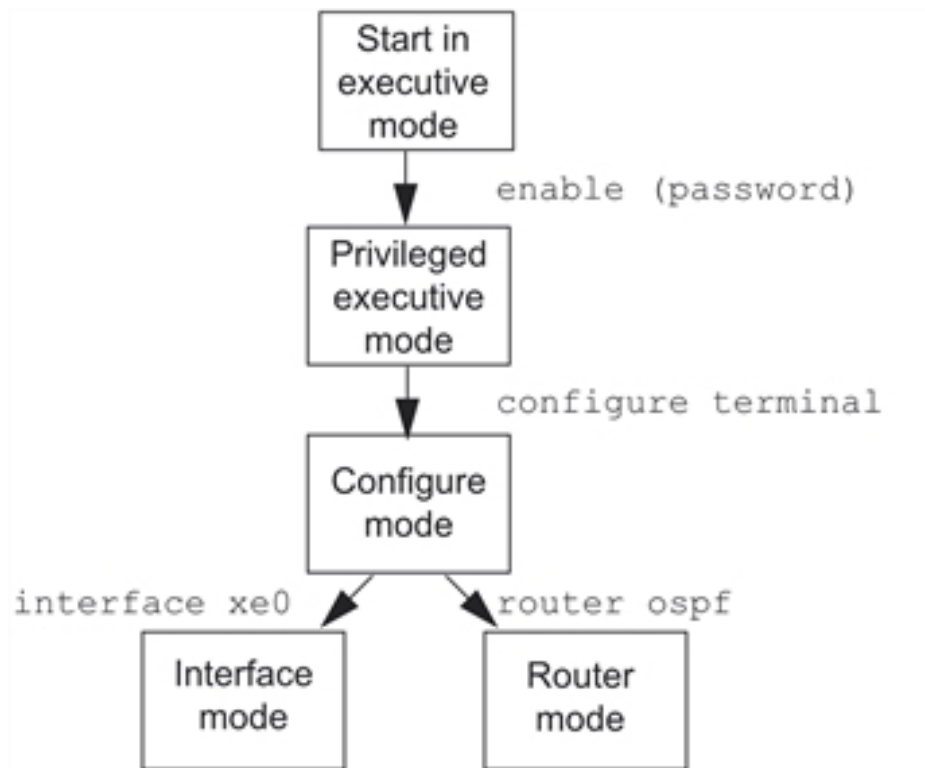

To change modes:

1. Enter privileged executive mode by entering **enable** in Executive mode.
2. Enter configure mode by entering **configure terminal** in Privileged Executive mode.

The example below shows moving from executive mode to privileged executive mode to configure mode and finally to router mode:

```

> enable mypassword
# configure terminal
Enter configuration commands, one per line. End with CNTL/Z.
(config)# router ospf
(config-router)#
  
```



Note: Each protocol can have modes in addition to the common command modes. See the command reference for the respective protocol for details.

Transaction-based Command-line Interface

The OcNOS command line interface is transaction based:

- Any changes done in configure mode are stored in a separate *candidate* configuration that you can view with the command.
- When a configuration is complete, apply the candidate configuration to the running configuration with the command.
- If a fails, no configuration is applied as the entire transaction is considered failed. You can continue to change the candidate configuration and then retry the .
- Discard the candidate configuration with the `abort transaction` command.
- Check the last aborted transaction with the `show transaction last-aborted` command.
- Multiple configurations cannot be removed with a single . You must remove each configuration followed by a `commit`.



Note: All commands MUST be executed only in the default CML shell (`cm1sh`). If you log in as root and start `imish`, then the system configurations will go out of sync. The `imish` shell is not supported and should not be started manually.

AUTHENTICATION MANAGEMENT CONFIGURATION

AAA Configuration for Console Connection	142
Overview	142
Configuration	142
Glossary	145
Restricted Access to Privilege Mode based on User Role	146
Overview	146
Prerequisites	146
Configuration	146
RADIUS Client Configuration	149
Overview	149
RADIUS Authorization Configuration	149
RADIUS Server Authentication Configuration	153
RADIUS Server Accounting	160
Fall Back Option for RADIUS Authentication	162
TACACS Client Configuration	164
Overview	164
TACACS Server Authentication	164
TACACS Server Accounting	173
TACACS Server Authorization	175
Role-Based Access Control	177
Overview	177
Benefits	178
Prerequisites	178
RBAC Configuration	178
Implementation Examples	180
RBAC Commands	180
Troubleshooting	190

AAA Configuration for Console Connection

Overview

OcNOS uses the Accounting, Authentication, Authorization (AAA) protocol to authenticate the user through **RADIUS**¹ or **TACACS**²+ remote servers or Local authentication server to give access to the device. The console port of the OcNOS is accessible (ssh or Telnet) only through the default **VRF**³ or VRF management port only. If the user attempts to access the device using the non VRF interface the access is denied.

The AAA authentication from console port via default VRF or VRF management is enhanced to reach the remote authentication servers through the non VRF interface.

Feature Characteristics

TACACS/RADIUS client can reach the OcNOS in both default and management VRF or non VRF interface for authentication.

Following are the features supported:

- Default VRF to reach the remote authentication (TACACS/RADIUS) server in Management VRF
- Management VRF to reach the loopback interface in Default VRF
- The AAA using servers are defined in default and management VRF
- When AAA server is not reachable, the authentication, authorization and accounting is performed via the local authentication server.
- AAA solution is performed based on the configuration only, not on the source of VRF.

Configuration

The following configuration uses the TACACS+ remote server for authentication. The same configurations are holds good for RADIUS authentication server.

Perform the following configurations on host.

1. Configure TACACS client using the configuration provided in [TACACS Client Configuration \(page 164\)](#) or [RADIUS Client Configuration \(page 149\)](#) section.
2. In the above configuration, configure the TACACS or RADIUS server in both management and default VRF. A sample configuration is provided below:

```
feature tacacs+ vrf management
tacacs-server login host 10.12.97.208 vrf management seq-num 1 key 7
0x67efdb4ad9d771c3ed8312b2bc74cedb
feature tacacs+
tacacs-server login host 40.40.40.1 seq-num 1 key 7 0x67efdb4ad9d771c3ed8312b2bc74cedb
tacacs-server login host 30.30.30.1 seq-num 2 key 7 0x67efdb4ad9d771c3ed8312b2bc74cedb
```

¹Remote Authentication Dial-In User Service

²Terminal Access Controller Access Control System

³Virtual Routing and Forwarding

3. Create server group for management VRF using the following CLI. This command changes the configure mode to server group (config-tacacs)#.

```
aaa group server tacacs+ TACACS_VRF_MGMT vrf management
```



Note: An AAA server group name configured in a VRF cannot be used to configure another VRF. For example, if the **TACACS_VRF_MGMT** server group is configured in the VRF management, you cannot configure an AAA server with the same name in any other VRFs.

4. Make the TACAC+S server 10.12.30.86 part of the group TACACS_VRF_MGMT for default VRF.

```
server 10.12.30.86
```

5. Configure the authentication behavior for TACACS+ server with default VRF management, non VRF and fall-back to local authentication server if none configured for management VRF.

```
aaa authentication login default vrf management group TACACS_VRF_MGMT TACACS_NON_VRF_MGMT local
```

6. Configure AAA behavior for management VRF using the following CLIs.

```
aaa accounting default vrf management group TACACS_VRF_MGMT TACACS_NON_VRF_MGMT local
aaa authorization default vrf management group TACACS_VRF_MGMT TACACS_NON_VRF_MGMT local
aaa authentication login default fallback error local non-existent-user vrf management
```

7. Create a server group for non VRF management using the following CLI. This command changes the configure mode to server group (config-tacacs)#.

```
aaa group server tacacs+ TACACS_NON_VRF_MGMT
server 40.40.40.1
server 30.30.30.1
```

8. Configure the authentication behavior for TACACS+ server with console VRF management, non VRF and fall-back to local authentication server if none configured for management VRF.

9. Configure AAA behavior for non management VRF using the following CLIs.

```
aaa authentication login console group TACACS_VRF_MGMT TACACS_NON_VRF_MGMT local
aaa accounting console group TACACS_VRF_MGMT TACACS_NON_VRF_MGMT local
aaa authorization console group TACACS_VRF_MGMT TACACS_NON_VRF_MGMT local
aaa authentication login console fallback error local non-existent-user
```



Note: If both management and default VRF is configured, then the default VRF is used to reach the TACACS/RADIUS server. If it is not reachable, then the management VRF is used.

Validation

Following is the sample validation show output for TACACS server with default management VRF and non VRF interface.

Following output shows the interface configured for server group.

```
OcNOS# sh tacacs-server groups
VRF: default
group tacacs+:
  server: all configured tacacs servers

group TACACS_NON_VRF_MGMT:
  server 40.40.40.1
  seq-num 1
```

```

port is 49
key is *****

server 30.30.30.1
seq-num 2
port is 49
key is *****

```

Following output shows the TACACS+ server configurations:

```

OcNOS#sh tacacs-server vrf management
VRF: management

total number of servers:1

Tacacs+ Server           : 10.12.97.208/49
  Sequence Number       : 1
  Failed Auth Attempts  : 0
  Success Auth Attempts : 0
  Failed Connect Attempts : 0
  Last Successful authentication:

```

(*) indicates last active.

```

OcNOS#sh tacacs-server
VRF: default

total number of servers:2

Tacacs+ Server           : 40.40.40.1/49
  Sequence Number       : 1
  Failed Auth Attempts  : 0
  Success Auth Attempts : 0
  Failed Connect Attempts : 0
  Last Successful authentication:

Tacacs+ Server           : 30.30.30.1/49
  Sequence Number       : 2
  Failed Auth Attempts  : 0
  Success Auth Attempts : 0
  Failed Connect Attempts : 0
  Last Successful authentication:

```

(*) indicates last active.

```

OcNOS#
OcNOS#show running-config tacacs+
feature tacacs+ vrf management
tacacs-server login host 10.12.97.208 vrf management seq-num 1 key 7
0x67efdb4ad9d771c3ed8312b2bc74cedb

```

```

feature tacacs+
tacacs-server login host 40.40.40.1 seq-num 1 key 7 0x67efdb4ad9d771c3ed8312b2bc74cedb
tacacs-server login host 30.30.30.1 seq-num 2 key 7 0x67efdb4ad9d771c3ed8312b2bc74cedb
Following output shows the AAA configurations:

```

```

OcNOS#show running-config aaa
aaa group server tacacs+ TACACS_VRF_MGMT vrf management
  server 10.12.97.208

aaa authentication login default vrf management group TACACS_VRF_MGMT TACACS_NON_VRF_MGMT local
aaa accounting default vrf management group TACACS_VRF_MGMT TACACS_NON_VRF_MGMT local
aaa authorization default vrf management group TACACS_VRF_MGMT TACACS_NON_VRF_MGMT local
aaa authentication login default fallback error local non-existent-user vrf management
aaa group server tacacs+ TACACS_NON_VRF_MGMT
  server 40.40.40.1
  server 30.30.30.1

```

```
aaa authentication login console group TACACS_VRF_MGMT TACACS_NON_VRF_MGMT local
aaa accounting console group TACACS_VRF_MGMT TACACS_NON_VRF_MGMT local
aaa authorization console group TACACS_VRF_MGMT TACACS_NON_VRF_MGMT local
aaa authentication login console fallback error local non-existent-user
```

Glossary

Key Terms/Acronym	Description
TACACS	Terminal Access Controller Access Control System

Restricted Access to Privilege Mode based on User Role

Overview

The Remote Authentication server is enhanced to provide access to execute mode or privilege level execute mode based on the network user's role. The authentication server can be Remote Authentication Dial-In User Service (**RADIUS**¹) or the Terminal Access Controller Access Control System (**TACACS**²) server.

This authorization behavior is enhanced to enable privilege level mode based on the user role specified in the RADIUS/TACACS server. A new CLI `disable default auto-enable` is introduced to implement it. Executing this CLI removes the default access to the privilege execute mode to any user.

Feature Characteristics

Removed the default login behavior of network-admin role and authenticate the user based on difference privilege level defined in the remote authentication

The authentications assumes the following:.

- If no privilege-level is specified in the authentication server, the default user role is "network-user".
- All the user logged into the privilege exec mode by default.
- Executing the `disable default auto-enable` CLI decides the execution mode only for "network-user" role based on the privilege level.
- The user role is deter

Prerequisites

The following is mandatory before issuing the `disable default auto-enable` CLI:

- Specify the RADIUS/TACACS server to authenticate the remote user login and enable the RADIUS/TACACS authentication.

```
radius-server login host 1.2.7.4 vrf management seq-num 1 key 7
0x67efdb4ad9d771c3ed8312b2bc74cedb
aaa authentication login default vrf management group radius
```

Configuration

Perform the following configurations on host to disable the privilege execute mode based the user role.

1. Configure **RADIUS**³/**TACACS**⁴ server using the configuration provided in [RADIUS Authorization Configuration \(page 149\)](#) or [TACACS Server Authentication \(page 164\)](#) section.

¹Remote Authentication Dial-In User Service

²Terminal Access Controller Access Control System

³Remote Authentication Dial-In User Service

⁴Terminal Access Controller Access Control System

- In the above configuration after enabling the authentication, execute **disable default auto-enable CLI** to get into network user executive mode based on user role.

```
(config)#radius-server login host 10.12.97.42 vrf management seq-num 1 key 0 testing123
OcNOS(config)#aaa authentication login default vrf management group radius
OcNOS(config)#disable default auto-enable
```



Note: By default this command is disabled.

Validation

Without configuring the **disable default auto-enable CLI**, if you login as remote user, user will be entered into privileged exec-mode.

```
radius-server login host 10.12.97.42 vrf management seq-num 1 key 7 0x67efdb4ad9
d771c3ed8312b2bc74cedb
```

```
root@instance-00000759:/home/ZebOS8NG# ssh ipil@10.12.159.128
ipil@10.12.159.128's password:
Linux OcNOS 4.19.91-ga6f5ae56f #1 SMP Sun Feb 11 13:19:33 UTC 2024 x86_64
Last login: Thu Feb 14 11:43:28 2019 from 10.12.43.197
OcNOS version UFI_S9500-30XS-XP-6.5.0 02/28/2024 07:28:24
```

```
OcNOS#show users
Current user : (*). Lock acquired by user : (#).
CLI user : [C]. Netconf users : [N].
Location : Applicable to CLI users.
Session : Applicable to NETCONF users.
```

```
Line User Idle Location/Session PID TYPE Role
(#) 0 con 0 [C]root 0d00h01m ttyS0 5093 Local network-admin
(*) 130 vty 0 [C]ipil 0d00h00m pts/0 5168 Remote network-user
```

After configuring the **disable default auto-enable CLI**, if you login as remote user with privilege level 0, user will be entered into exec-mode.

```
root@instance-00000759:/home/ZebOS8NG# ssh ipil@10.12.159.128
ipil@10.12.159.128's password:
Linux OcNOS 4.19.91-ga6f5ae56f #1 SMP Sun Feb 11 13:19:33 UTC 2024 x86_64
Last login: Thu Feb 14 14:02:48 2019 from 10.12.43.197
OcNOS version UFI_S9500-30XS-XP-6.5.0 02/28/2024 07:28:24
```

```
OcNOS>en
OcNOS#show users
Current user : (*). Lock acquired by user : (#).
CLI user : [C]. Netconf users : [N].
Location : Applicable to CLI users.
Session : Applicable to NETCONF users.
```

```
Line User Idle Location/Session PID TYPE Role
(#) 0 con 0 [C]root 0d00h00m ttyS0 5093 Local network-admin
(*) 130 vty 0 [C]ipil 0d00h00m pts/0 5207 Remote network-user
```

After configuring the **disable default auto-enable CLI**, if you login as remote user with privilege level 1-15, the user will be entered into privileged execution mode.

```
root@instance-00000759:/home/ZebOS8NG# ssh ipi@10.12.159.128
ipi@10.12.159.128's password:
Linux OcNOS 4.19.91-ga6f5ae56f #1 SMP Sun Feb 11 13:19:33 UTC 2024 x86_64
OcNOS version UFI_S9500-30XS-XP-6.5.0 02/28/2024 07:28:24
```

```
OcNOS#show users
```

```
Current user : (*). Lock acquired by user : (#).
CLI user : [C]. Netconf users : [N].
Location : Applicable to CLI users.
Session : Applicable to NETCONF users.

Line User Idle Location/Session PID TYPE Role
(#) 0 con 0 [C]root 0d00h01m ttyS0 5093 Local network-admin
(*) 130 vty 0 [C]ipi 0d00h00m pts/0 5239 Remote network-engineer
```

CLI Commands

RADIUS authentication introduces the following configuration commands starting from OcNOS version 6.5.1. For more details, refer to the [disable default auto-enable \(page 205\)](#) topic.

Glossary

Key Terms/Acronym	Description
RADIUS	Remote Authentication Dial-In User Service
TACACS	Terminal Access Controller Access Control System server

RADIUS Client Configuration

Overview

Remote Authentication Dial In User Service (**RADIUS**¹) is a remote authentication protocol that is used to communicate with an authentication server. A RADIUS server is responsible for receiving user connection requests, authenticating the user, and then returning all configuration information necessary for the client to deliver service to the user.

The OcNOS device, acting as a RADIUS client, sends the user's credentials to the RADIUS server requesting authentication. The RADIUS server validates the received user's credentials and authenticates it. After the authentication, it authorizes the user's privilege level and shares it with the OcNOS. Thus, the user role is decided based on the received privilege level.

The key points for RADIUS authentication are:

- Transactions between client and server are authenticated through the use of a shared key and this key is never sent over the network.
- The password is encrypted before sending it over the network.
- A maximum of eight RADIUS servers can be configured.

Limitation

- If the privilege level is not specified in the radius server's user config file, the default role is considered "network-user."
- By default, the Privileged Exec mode is given to all the users

In OcNOS version 6.4.1, the RADIUS is not present on radius server or authentication fails from RADIUS server

To implement the above requirements, the existing CLI [Authentication, Authorization and Accounting \(page 193\)](#) is used to enable fallback to local authentication server. This is disabled by default.

By default, the fallback to local authentication is applied when the Radius server is unreachable. For other scenarios, enable the fallback using the CLI.



Note: For invalid secret key there is no fallback local authentication. Console authentication is not supported for Radius.

In OcNOS version 6.4.2, the RADIUS Authorization is supported.

RADIUS Authorization Configuration

Benefits

Based on the privilege level received from the **RADIUS**² server user role is determined.

¹Remote Authentication Dial-In User Service

²Remote Authentication Dial-In User Service

Prerequisites

RADIUS server process must be up and running.

Configuration

Topology

Following is the RADIUS client and server network topology.

Figure 2. RADIUS Server Client Configuration



IPv4 Address

RADIUS server address is configured in IPv4 address format.

RADIUS Client (Host)

<pre>(config)#radius-server login host 10.12.33.211 vrf management seq-num 1 key 0 testing123</pre>	Specify the radius server ipv4 address to be configured with shared local key for management vrf. The same key should be present on the server config file.
<pre>(config)#radius-server login host 1.1.1.2 seq-num 1 key 0 testing123</pre>	Specify the radius server ipv4 address to be configured with shared local key for default vrf. The same key should be present on the server config file.
<pre>(config)#aaa authentication login default vrf management group radius</pre>	Enable authentication for radius server configured for management VRF ¹ . Authorization is also enabled by default.
<pre>(config)#aaa authentication login console group radius</pre>	Enable authentication for radius server . Authorization is also enabled by console
<pre>(config)#aaa authentication login default vrf management group radius local</pre>	Enable authentication for radius server and fallback to local configured for management VRF. Authorization is also enabled by default
<pre>(config)#aaa authentication login console group radius local</pre>	Enable authentication for radius server and fallback to local configured for default vrf. Authorization is also enabled by default

¹Virtual Routing and Forwarding

Specifies privilege level in `radius server` configuration file. The RADIUS client fetch the network operator privilege level from this file. The Privilege level range is between 0-15.

Table 8. Role/privilege level mapping

Role	Privilege level
Network-admin	15
Network engineer	14
RBAC-customized-role	13
Network operator	1 to 12
Network user	0 or any other values (>15 or negative values or any character)

Validation

To verify the RADIUS authorization process, login from the host machine to Host IP with the authenticating user credentials and provide a RADIUS server password.

Execute following show commands to verify the Radius authorization status.

```
OcnOS#sh running-config aaa
aaa authentication login default vrf management group radius
aaa authentication login console group radius
aaa authentication login default vrf management group radius local
aaa authentication login console group radius local

OcnOS#sh running-config radius
radius-server login host 10.12.33.211 vrf management seq-num 1 key 7
0x67efdb4ad9d771c3ed8312b2bc74cedb

radius-server login host 1.1.1.1 seq-num 1 key 7 0x67efdb4ad9d771c3ed8312b2bc74cedb

OcnOS#sh radius-server vrf management
timeout value: 5

Total number of servers:1

VRF: management
Following RADIUS servers are configured:
Radius Server           : 10.12.33.211 (*)
  Sequence Number       : 1
  available for authentication on port : 1812
  available for accounting on port    : 1813
  RADIUS shared secret   : *****
  Failed Authentication count         : 3
  Successful Authentication count    : 13
  Failed Connection Request          : 3
  Last Successful authentication     : 2023 November 30, 06:25:07

OcnOS#sh radius-server vrf management
timeout value: 5

Total number of servers:1

VRF: management
Following RADIUS servers are configured:
Radius Server           : 1.1.1.1 (*)
  Sequence Number       : 1
  available for authentication on port : 1812
  available for accounting on port    : 1813
  RADIUS shared secret   : *****
  Failed Authentication count         : 3
```

```

Successful Authentication count      : 10
Failed Connection Request          : 0
Last Successful authentication      : 2023 November 30, 06:28:07

```

```

OcNOS#sh users
Current user      : (*). Lock acquired by user : (#).
CLI user         : [C]. Netconf users         : [N].
Location        : Applicable to CLI users.
Session         : Applicable to NETCONF users.

```

Line	User	Idle	Location/Session	PID	TYPE	Role
(*) 0 con 0	[C]ocnos	0d00h00m	ttyS0	5251	Local	network-admin
130 vty 0	[C]ocnos	0d00h00m	pts/0	5288	Remote	network-user
131 vty 1	[C]abc	0d00h00m	pts/1	5340	Remote	network-engineer
132 vty 2	[C]ipi	0d00h00m	pts/2	5350	Remote	network-operator

IPv6 Address

RADIUS server address is configured in IPv6 address.

RADIUS Client (Host)

OcNOS(config)#radius-server login host 2001:db8:100::2 vrf management seq-num 1 key 0 testing123	Configure radius server with IPv6 address
OcNOS(config)#aaa authentication login default vrf management group radius local	Configure AAA authentication
(config)#interface eth0	Navigate to the interface mode
(config-if)#ipv6 address 2001:db8:100::5/64	Configure IPv6 address on the eth0 interface
(config-if)#exit	Exit interface configure mode
(config)#commit	Commit the configuration
(config)#exit	Exit configure mode

Validation

To verify the RADIUS authorization process, login from the host machine to Host IP with the authenticating user credentials and provide a RADIUS server password.

Execute following show commands to verify the Radius authorization status.

```

#show running-config radius
radius-server login host 2001:db8:100::2 vrf management seq-num 1 key 7
0x67efdb4ad9d771c3ed8312b2bc74cedb

#show running-config aaa
aaa authentication login default vrf management group radius

#show ipv6 interface eth0 brief
Interface      IPv6-Address      Admin-Status
eth0           2001:db8:100::5fe80::218:23ff:fe30:e6ba  [up/up]

```

Implementation Examples

Following is an example for **radius-server** configuration file:

```

ipi Cleartext-Password := "ipi123"
  Management-Privilege-Level := 12
ocnos Cleartext-Password := "ocnos"
  Management-Privilege-Level := 0
abc Cleartext-password :="AC123"
  Management-Privilege-Level := 14
    
```

RADIUS Server Authentication Configuration

IPv4 Address

Radius server address is configured as IPv4 address.

Topology

Figure 3. RADIUS¹ Server Host Configuration



Host

#configure terminal	Enter configure mode.
(config)#radius-server login key testing101 vrf management	Specify the global key for radius servers that are not configured with their respective keys for management vrf. This key should match the one present in the config file of tacacs server.
(config)#radius-server login key testing101	Specify the global key for radius servers that are not configured with their respective keys for default vrf. This key should match the one present in the config file of tacacs server
(config)#radius-server login host 10.12.17.13 vrf management seq-num 1 key testing123	Specify the radius server ipv4 address to be configured with shared local key for management vrf. The same key should be present on the server config file.
(config)#radius-server login host 10.12.17.13 seq-num 2 key testing123	Specify the radius server ipv4 address to be configured with shared local key for default vrf. The same key should be present on the server config file.
(config)#radius-server login host 10.12.17.11 vrf management seq-num 1 auth-port 1045	Specify the radius server ipv4 address to be configured with port number for management vrf. The

¹Remote Authentication Dial-In User Service

	radius server should be started with same port number.
<pre>(config)#radius-server login host 10.12.17.11 seq- num 1 auth-port 1045</pre>	Specify the radius server ipv4 address to be configured with port number for default vrf. The radius server should be started with same port number
<pre>(config)#radius-server login host 10.12.17.11 vrf management seq-num 1 key 7 wawyanb123 auth-port 60000 acct-port 60000 timeout 6</pre>	Specify the radius server ipv4 address to be configured with authentication port number, accounting port number, shared key for management vrf. The radius server should be started with same port number.
<pre>(config)#radius-server login host 10.12.17.11 seq- num 1 key 7 wawyanb123 auth-port 60000 acct-port 60000 timeout 6</pre>	Specify the radius server ipv4 address to be configured with authentication port number, accounting port number, shared key for default vrf. The radius server should be started with same port number. The radius server should be started with same port number
<pre>(config)#radius-server login host Radius-Server-1 vrf management seq-num 2 key 7 wawyanb123 auth-port 60000 acct-port 60000 timeout 2</pre>	Specify the radius server configured with hostname, key authentication port number, accounting port number, for management VRF ¹ . The radius server should be started with same port number
<pre>(config)#radius-server login host Radius-Server-1 seq-num 2 key 7 wawyanb123 auth-port 60000 acct- port 60000 timeout 2</pre>	Specify the radius server configured with hostname sequence number, key and port number for default VRF. The radius server should be started with same port number.
<pre>(config)#aaa authentication login default vrf management group radius</pre>	Enable authentication for radius server configured for management VRF. Authorization is also enabled by default
<pre>(config)#aaa authentication login default group radius</pre>	Enable authentication for radius server configured for default vrf. Authorization is also enabled by default.
<pre>(config)#aaa authentication login default vrf management group radius local</pre>	Enable authentication for radius server and fallback to local configured for management VRF. Authorization is also enabled by default
<pre>(config)#aaa authentication login default group radius local</pre>	Enable authentication for radius server and fallback to local configured for default vrf. Authorization is also enabled by default
<pre>(config)#aaa authentication login default vrf management group radius local none</pre>	Enable authentication for radius server, fallback to local followed by fallback to none, configured for management VRF. Authorization is also enabled by default
<pre>(config)#aaa authentication login default radius local none</pre>	Enable authentication for radius server, fallback to local followed by fallback to none, configured for default vrf. Authorization is also enabled by default

¹Virtual Routing and Forwarding

(config)#aaa authentication login default vrf management group radius none	Enable authentication for radius, fallback to none, configured for management VRF. Authorization is also enabled by default
(config)#aaa authentication login default group radius none	Enable authentication for radius, fallback to none, configured for default VRF. Authorization is also enabled by default
(config)#aaa group server radius G1 vrf management	Create aaa radius group G1 for management vrf
(config)#aaa group server radius G1	Create AAA radius group G1 for default VRF
(config-radius)#server 10.12.17.11	Make the radius server 10.12.30.86 a part of this group G1 for default VRF
(config-radius)#server Radius-Server-1	Make Radius-Server-1 a part of this group G1
(config-radius)#exit	Exit radius mode
(config)#commit	Commit the configuration
(config)#aaa group server radius G1	Enter radius mode
(config-radius)#server 10.12.17.11	Make the radius server 10.12.30.86 a part of this group G1 for default vrf
(config-radius)#server Radius-Server-1	Make Radius-Server-1 a part of this group G1
(config-radius)#exit	Exit radius mode.
(config)#commit	Commit the configuration
(config)#aaa authentication login default vrf management group G1	Authenticate the tacacs+ group G1 with aaa authentication for management vrf
(config)#aaa authentication login default group G1	Authenticate the tacacs+ group G1 with aaa authentication for default vrf
(config)#commit	Commit the configuration

Validation

To verify the RADIUS authentication process, use SSH or Telnet from the host machine to Host IP with the authenticating user created, and provide a RADIUS server password and check whether the client validates the user with the corresponding username and password.

```
#show radius-server vrf management
      VRF: management
timeout value: 5

Total number of servers:2

Following RADIUS servers are configured:
Radius Server      : 10.12.17.13
  Sequence Number  : 1
  available for authentication on port : 60000
  available for accounting on port    : 60000
  timeout          : 2
  RADIUS shared secret : *****
  Failed Authentication count : 0
  Successful Authentication count : 2
  Failed Connection Request : 2
  Last Successful authentication : 2000 January 05, 20:55:44
Radius Server      : 10.12.17.11 (*)
  Sequence Number  : 2
```

```

available for authentication on port : 60000
available for accounting on port    : 60000
timeout                             : 2
RADIUS shared secret                : *****
Failed Authentication count         : 1
Successful Authentication count     : 1
Failed Connection Request          : 0
Last Successful authentication      : 2000 January 05, 20:58:33

#show radius-server
    VRF: default
timeout value: 5

Total number of servers:4

Following RADIUS servers are configured:
Radius Server                       : 192.168.1.1
    Sequence Number                  : 1
    available for authentication on port : 60000
    available for accounting on port    : 60000
    timeout                           : 2
    RADIUS shared secret              : *****
    Failed Authentication count        : 0
    Successful Authentication count    : 1
    Failed Connection Request         : 2
    Last Successful authentication     : 2000 January 05, 20:45:09

Radius Server                       : 100.0.0.1 (*)
    Sequence Number                  : 2
    available for authentication on port : 60000
    available for accounting on port    : 60000
    timeout                           : 2

Radius Server                       : 100.0.0.1 (*)
    Sequence Number                  : 2
    available for authentication on port : 60000
    available for accounting on port    : 60000
    timeout                           : 2
    RADIUS shared secret              : *****
    Failed Authentication count        : 1
    Successful Authentication count    : 1
    Failed Connection Request         : 0
    Last Successful authentication     : 2000 January 05, 20:46:36

#show radius-server vrf management
    VRF: management
timeout value: 5

Total number of servers:2

Following RADIUS servers are configured:
Radius Server                       : 10.12.17.13
    Sequence Number                  : 1
    available for authentication on port : 60000
    available for accounting on port    : 60000
    timeout                           : 2
    RADIUS shared secret              : *****
    Failed Authentication count        : 0
    Successful Authentication count    : 2
    Failed Connection Request         : 2
    Last Successful authentication     : 2000 January 05, 20:55:44
Radius Server                       : 10.12.17.11 (*)
    Sequence Number                  : 2
    available for authentication on port : 60000
    available for accounting on port    : 60000
    timeout                           : 2
    RADIUS shared secret              : *****
    Failed Authentication count        : 1

```

```

    Successful Authentication count      : 1
    Failed Connection Request           : 0
    Last Successful authentication      : 2000 January 05, 20:58:33

#show radius-server
    VRF: default
    timeout value: 5

Total number of servers:4

Following RADIUS servers are configured:
Radius Server                          : 192.168.1.1
    Sequence Number                     : 1
    available for authentication on port : 60000
    available for accounting on port    : 60000
    timeout                             : 2
    RADIUS shared secret                : *****
    Failed Authentication count         : 0
    Successful Authentication count     : 1
    Failed Connection Request           : 2
    Last Successful authentication      : 2000 January 05, 20:45:09

Radius Server                          : 100.0.0.1 (*)
    Sequence Number                     : 2
    available for authentication on port : 60000
    available for accounting on port    : 60000
    timeout                             : 2

Radius Server                          : 100.0.0.1 (*)
    Sequence Number                     : 2
    available for authentication on port : 60000
    available for accounting on port    : 60000
    timeout                             : 2
    RADIUS shared secret                : *****
    Failed Authentication count         : 1
    Successful Authentication count     : 1
    Failed Connection Request           : 0
    Last Successful authentication      : 2000 January 05, 20:46:36

#show radius-server vrf all
    VRF: management
    timeout value: 5

Total number of servers:2

Following RADIUS servers are configured:
Radius Server                          : 10.12.17.13
    Sequence Number                     : 1
    available for authentication on port : 60000
    available for accounting on port    : 60000
    timeout                             : 2
    RADIUS shared secret                : *****
    Failed Authentication count         : 0
    Successful Authentication count     : 2
    Failed Connection Request           : 2
    Last Successful authentication      : 2000 January 05, 20:55:44
Radius Server                          : 10.12.17.11 (*)
    Sequence Number                     : 2
    available for authentication on port : 60000
    available for accounting on port    : 60000
    timeout                             : 2
    RADIUS shared secret                : *****
    Failed Authentication count         : 1
    Successful Authentication count     : 1
    Failed Connection Request           : 0
    Last Successful authentication      : 2000 January 05, 20:58:33

    VRF: default

```

```

timeout value: 5

Total number of servers:4

Following RADIUS servers are configured:
Radius Server           : 192.168.1.1
  Sequence Number       : 1
  available for authentication on port : 60000
  available for accounting on port    : 60000
  timeout                : 2
  RADIUS shared secret   : *****
  Failed Authentication count         : 0
  Successful Authentication count    : 1
  Failed Connection Request          : 2
  Last Successful authentication    : 2000 January 05, 20:45:09

Radius Server           : 100.0.0.1 (*)
  Sequence Number       : 2
  available for authentication on port : 60000
  available for accounting on port    : 60000
  timeout                : 2
  RADIUS shared secret   : *****
  Failed Authentication count         : 1
  Successful Authentication count    : 1
  Failed Connection Request          : 0
  Last Successful authentication    : 2000 January 05, 20:46:36

#show running-config radius
radius-server login key 7 0x6f32ba3f9e05a3db vrf management
radius-server login host 10.12.17.13 vrf management seq-num 1 key 7
0x67efdb4ad9d771c3ed8312b2bc74cedb

#show running-config aaa
aaa authentication login default vrf management group radius
aaa group server radius rad1 vrf management
  server Radius-Server-1 vrf management
  server 100.0.0.1 vrf management

aaa authentication login default group radius
aaa group server radius rad1
  server Radius-Server-1
  server 100.0.0.1

#show running-config aaa all
aaa authentication login default vrf management group radius
aaa authentication login console local
aaa accounting default vrf management local
no aaa authentication login default fallback error local vrf management
no aaa authentication login console fallback error local
no aaa authentication login error-enable vrf management
aaa local authentication attempts max-fail 3
aaa local authentication unlock-timeout 1200
aaa group server radius rad1 vrf management
  server Radius-Server-1 vrf management
  server 100.0.0.1 vrf management

aaa authentication login default group radius
aaa authentication login console local
aaa accounting default local
no aaa authentication login default fallback error local
no aaa authentication login console fallback error local
no aaa authentication login error-enable
aaa local authentication attempts max-fail 3
aaa local authentication unlock-timeout 1200
aaa group server radius rad1
  server Radius-Server-1
  server 100.0.0.1

```

IPv6 Address

Radius server address is configured as IPv6 address. Authentication messages are transmitted to radius server from the Router using IPv6 address.

Topology

[Figure 4. RADIUS topology \(page 159\)](#) shows the sample configuration of Radius server.

Figure 4. RADIUS¹ topology



R1

<code>#configure terminal</code>	Enter configure mode.
<code>(config)#radius-server login host 2001:db8:100::2 vrf management seq-num 1 key 0 testing123</code>	Configure radius server with IPv6 address
<code>(config)#aaa authentication login default vrf management group radius</code>	Configure AAA authentication
<code>(config)#aaa authentication login error-enable vrf management</code>	Configure AAA authentication login error-enable
<code>(config)#interface eth0</code>	Navigate to the interface mode
<code>(config-if)#ipv6 address 2001:db8:100::5/64</code>	Configure IPv6 address on the eth0 interface
<code>(config-if)#exit</code>	Exit interface configure mode
<code>(config)#commit</code>	Commit the configuration
<code>(config)#exit</code>	Exit configure mode

Validation

Perform TELNET to the Router R1. Provide the username mentioned in the radius server "users" file as telnet username. Check that R1 sends radius request to the radius server using IPv6 address.

```
#show running-config radius
radius-server login host 2001:db8:100::2 vrf management seq-num 1 key 7 0x67efdb
4ad9d771c3ed8312b2bc74cedb
```

¹Remote Authentication Dial-In User Service

```
#show running-config aaa
aaa authentication login default vrf management group radius
aaa authentication login error-enable vrf management

#show ipv6 interface eth0 brief
Interface          IPv6-Address          Admin-Sta
tus
eth0                2001:db8:100::5
                   fe80::218:23ff:fe30:e6ba          [up/up]
```

RADIUS Server Accounting

You can configure accounting to measure the resources that another user consumes during access.

User

#configure terminal	Enter configure mode.
(config)#radius-server login host 10.12.17.11 vrf management key 7 seq-num 1 wawyanb123 auth-port 60000 acct-port 60000 timeout 6	Specify the radius server ipv4 address to be configured with authentication port number, accounting port number, shared key for management vrf. The radius server should be started with same port number.
(config)#radius-server login host 10.12.17.11 seq-num 2 key 7 wawyanb123 auth-port 60000 acct-port 60000 timeout 6	Specify the radius server ipv4 address to be configured with port number for default vrf. The radius server should be started with same port number
(config)#aaa accounting default vrf management group radius	Enable accounting for radius server configured for vrf management
(config)#aaa accounting default group radius	Enable accounting for radius server configured for default vrf
(config)#commit	Commit the candidate configuration to the running configuration

Validation

```
#show aaa accounting vrf management
VRF: management
default: group radius

#show aaa accounting vrf all
VRF: management
default: group radius

VRF: default
default: group radius

#show aaa accounting
VRF: default
default: group radius
#
#show running-config aaa
aaa authentication login default vrf management group radius
aaa accounting default vrf management group radius
aaa group server radius rad1 vrf management
server Radius-Server-1 vrf management
server 100.0.0.1 vrf management
```

```
aaa authentication login default group radius
aaa accounting default group radius
aaa group server radius rad1
    server Radius-Server-1
    server 100.0.0.1
```

Sample Radius Clients.conf File

```
client 10.12.58.20 {
    secret      = testing123
    shortname = localhost
}
client 192.168.1.2 {
    secret      = testing123
    shortname = localhost
}
client 10.12.37.196 {
    secret      = testing123
}
client 100.0.0.2 {
    secret      = testing123
    shortname = localhost
}

# IPv6 Client
#client ::1 {
#    secret      = testing123
#    shortname = localhost
#}
#
# All IPv6 Site-local clients
#client fe80::/16 {
#    secret      = testing123
#    shortname = localhost
#}
```

Sample Radius Users Configuration File

```
#
#DEFAULT
#    Service-Type = Login-User,
#    Login-Service = Rlogin,
#    Login-IP-Host = shellbox.ispdomain.com

# #
# # Last default: shell on the local terminal server.
# #
# DEFAULT
#    Service-Type = Administrative-User

# On no match, the user is denied access.

selftest Cleartext-Password := "password"
testuser1 Cleartext-Password := "user1@101"
testuser2 Cleartext-Password := "user2@202"
testuser3 Cleartext-Password := "user3@303"
```

Fall Back Option for RADIUS Authentication

Overview

Currently, the Remote Authentication Dial-In User Service (**RADIUS**¹) server authentication fallback to the local authentication server only when the RADIUS server is not reachable.

This behavior is modified to forward the authentication request to the local authentication server when the RADIUS authentication is failed or not reachable.

Feature Characteristics

The RADIUS authentication mechanism is enhanced to fallback to local authentication server when the user

- is not present on RADIUS server or
- authentication fails from RADIUS server

To implement the above requirements, the existing CLI `aaa authentication login default fallback error local non-existent-user vrf management` is used to enable fallback to local authentication server. This is disabled by default.



Note: For invalid secret key there is no fallback local authentication. Console authentication is not supported for RADIUS.

Benefits

By default, the fallback to local authentication is applied when the RADIUS server is unreachable. For other scenarios, enable the fallback using the CLI.

Configuration

Below is the existing CLI used to enable the fallback local authentication server.

```
aaa authentication login default fallback error local non-existent-user vrf management
```

Refer to [Authentication, Authorization and Accounting \(page 193\)](#) section in the OcNOS System Management Configuration Guide.

Validation

Configure `aaa authentication` console and verify console authentication:

```
OcNOS#con t
Enter configuration commands, one per line. End with CNTL/Z.
OcNOS(config)#radius-server login host 1.1.1.2 seq-num 1 key 0 kumar
OcNOS(config)#commit
OcNOS(config)#aaa authentication login console group radius
OcNOS(config)#commit
OcNOS(config)#exit
OcNOS#exit

OcNOS#show users
Current user      : (*). Lock acquired by user : (#).
CLI user         : [C]. Netconf users          : [N].
```

¹Remote Authentication Dial-In User Service

```
Location : Applicable to CLI users.  
Session  : Applicable to NETCONF users.
```

Line	User	Idle	Location/Session	PID	TYPE	Role
(*) 0 con 0	[C]ocnos	0d00h00m	ttyS0	5531	Remote	network-admin

Enabled RADIUS local fallback and verify the authentication:

```
OcNOS(config)#aaa authentication login console group radius local  
OcNOS(config)#commit  
OcNOS(config)#exit  
OcNOS#exit  
OcNOS>exit
```

```
OcNOS>enable
```

```
OcNOS#show users
```

```
Current user      : (*). Lock acquired by user : (#).
```

```
CLI user         : [C]. Netconf users       : [N].
```

```
Location : Applicable to CLI users.
```

```
Session  : Applicable to NETCONF users.
```

Line	User	Idle	Location/Session	PID	TYPE	Role
(*) 0 con 0	[C]test	0d00h00m	ttyS0	5713	Local	network-engineer
130 vty 0	[C]test	0d00h01m	pts/0	5688	Local	network-engineer

```
OcNOS#
```

TACACS Client Configuration

Overview

Terminal Access Controller Access Control System (**TACACS¹**) is a remote authentication protocol that is used to communicate with an authentication server. With TACACS, a network device communicates to an authentication server to determine whether a particular user should be allowed access to the device. TACACS+ listens at port 49.

TACACS Server Authentication

IPv4 Address Configuration

This section shows a **TACACS²** server is configured with an IPv4 address. Authentication messages are transmitted to TACACS+ server from the device using an IPv4 address.

Topology

Figure 5 shows the sample configuration of TACACS+ server.

Figure 5. TACACS Server Host Configuration

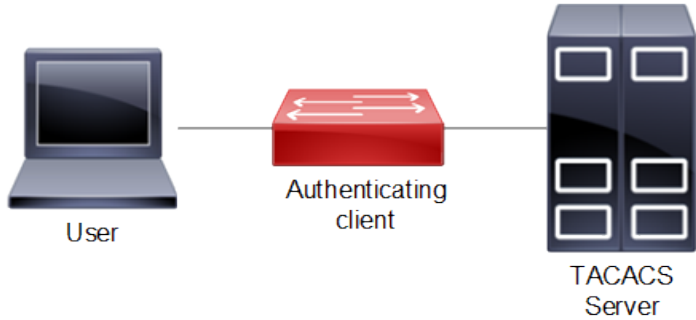

Authenticating Client

<code>#configure terminal</code>	Enter configure mode.
<code>(config)#feature tacacs+ vrf management</code>	Enable the feature TACACS+ for management vrf
<code>(config)#feature tacacs+</code>	Enable the feature TACACS+. for default vrf
<code>(config)#tacacs-server login key 0 testing101 vrf management</code>	Specify the global key for tacacs servers that are not configured with their respective keys for management vrf This key should match the one present in the config file of tacacs server
<code>(config)#tacacs-server login key 0 testing101</code>	Specify the global key for tacacs servers that are not configured with their respective keys for default vrf This

¹Terminal Access Controller Access Control System

²Terminal Access Controller Access Control System

	key should match the one present in the config file of tacacs server
<pre>(config)#tacacs-server login host 10.16.19.2 vrf management seq-num 1 key 0 testing123</pre>	Specify the tacacs server ipv4 address to be configured with shared key. The same key should be present on the server config file
<pre>(config)#tacacs-server login host 10.16.19.2 seq- num 3 key 0 testing123</pre>	Specify the tacacs server ipv4 address to be configured with shared local key for default vrf The same key should be present on the server config file.
<pre>(config)#tacacs-server login host 10.12.30.86 vrf management seq-num 4 port 1045</pre>	Specify the tacacs server ipv4 address to be configured with the sequence and port number. The tacacs server should be started with same port number
<pre>config)#tacacs-server login host 10.12.30.86 seq- num 2 port 1045</pre>	Specify the tacacs server ipv4 address to be configured with the sequence and port number for default vrf. The tacacs server should be started with same port number
<pre>(config)#tacacs-server login host 10.12.17.11 vrf management seq-num 8 key 7 65535 port 65535</pre>	Specify the tacacs server ipv4 address to be configured with the sequence, key and port number for management vrf. The tacacs server should be started with same port number.
<pre>(config)#tacacs-server login host 10.12.17.11 seq-num 8 key 7 65535 port 65535</pre>	Specify the tacacs server ipv4 address to be configured with the sequence, key and port number for default vrf. The tacacs server should be started with same port number.
<pre>(config)#tacacs-server login host Tacacs-Server-1 vrf management seq-num 7 key 7 65535 port 65535</pre>	Specify the tacacs server configured with host-name sequence number key and port number for management vrf. The tacacs server should be started with same port number
<pre>(config)#tacacs-server login host Tacacs-Server-1 seq-num 7 key 7 65535 port 65535</pre>	Specify the tacacs server configured with host-name sequence number key and port number for default vrf. The tacacs server should be started with same port number
<pre>(config)#aaa authentication login default vrf management group tacacs+</pre>	Enable authentication for TACACS+ server configured for management vrf. Authorization is also enabled by default
<pre>(config)#aaa authentication login default group tacacs+</pre>	Enable authentication for TACACS+ server configured for default vrf. Authorization is also enabled by default.
<pre>(config)#aaa authentication login default vrf management group tacacs+ local</pre>	Enable authentication for TACACS+ and fall-back to local configured for management vrf. Authorization is also enabled by default
<pre>(config)#aaa authentication login default vrf management group tacacs+ local none</pre>	Enable authentication for TACACS+ fall-back to local followed by fall-back to none configured for management vrf. Authorization is also enabled by default
<pre>(config)#aaa authentication login default vrf management group tacacs+ none</pre>	Enable authentication for TACACS+ fall-back to none configured for management vrf. Authorization is also enabled by default

(config)#aaa authentication login default group tacacs+ none	Enable authentication for TACACS+ fall-back to none , configured for default vrf. Authorization is also enabled by default
(config)#aaa group server tacacs+ G1 vrf management	Create aaa group G1 for management vrf
(config-tacacs)#server 10.12.30.86 vrf management	Make the tacacs-server 10.12.30.86 a part of this group G1 for default vrf
(config-tacacs)#server Tacacs-Server-1	Make the tacacs-server Tacacs-Server-1 a part of this group G1 for management vrf
(config-tacacs)#exit	Exit the tacacs-config
(config)#commit	Commit the configuration
(config)#aaa group server tacacs+ G1	Create aaa group G1 for default vrf
(config-tacacs)server 10.12.30.86	Make the tacacs-server 10.12.30.86 a part of this group G1 for default vrf
(config-tacacs)#server Tacacs-Server-1	Make the tacacs-server Tacacs-Server-1 a part of this group G1 for management vrf
(config-tacacs)#exit	Exit the tacacs-config mode
(config)#commit	Commit the configuration
(config)#aaa authentication login default vrf management group G1	Authenticate the tacacs+ group G1 with aaa authentication for management vrf
(config)#aaa authentication login default group G1	Authenticate the tacacs+ group G1 with aaa authentication for default vrf
(config)#commit	Commit the configuration

Users are mapped as shown in [Table 9](#):

Table 9. Role/privilege level mapping

Role	Privilege level
Network administrator	15
Network engineer	14
Network operator	1 to 12
RBAC-customized-role	13
Network user	0 or any other values (>15 or negative values or any character)

Validation

```
Leaf1#show tacacs-server vrf management
      VRF: management
total number of servers:4

Tacacs+ Server           : 10.16.19.2/49
      Sequence Number    : 1
```

```

    Failed Auth Attempts      : 0
    Success Auth Attempts    : 0
    Failed Connect Attempts  : 0
    Last Successful authentication:

Tacacs+ Server               : 10.12.30.86/1045
    Sequence Number          : 2
    Failed Auth Attempts    : 0
    Success Auth Attempts   : 0
    Failed Connect Attempts : 0
    Last Successful authentication:

Tacacs+ Server               : Tacacs-Server-1/65535
    Sequence Number          : 7
    Failed Auth Attempts    : 0
    Success Auth Attempts   : 0
    Failed Connect Attempts : 0
    Last Successful authentication:

Tacacs+ Server               : 10.12.17.11/65535
    Sequence Number          : 8
    Failed Auth Attempts    : 0
    Success Auth Attempts   : 0
    Failed Connect Attempts : 0
    Last Successful authentication:

Leaf1#show tacacs-server
    VRF: default
total number of servers:4

Tacacs+ Server               : 10.16.19.2/49
    Sequence Number          : 1
    Failed Auth Attempts    : 0
    Success Auth Attempts   : 0
    Failed Connect Attempts : 0
    Last Successful authentication:

Tacacs+ Server               : 10.12.30.86/1045
    Sequence Number          : 2
    Failed Auth Attempts    : 0
    Success Auth Attempts   : 0
    Failed Connect Attempts : 0
    Last Successful authentication:

Tacacs+ Server               : Tacacs-Server-1/65535
    Sequence Number          : 7
    Failed Auth Attempts    : 0
    Success Auth Attempts   : 0
    Failed Connect Attempts : 0
    Last Successful authentication:

Tacacs+ Server               : 10.12.17.11/65535
    Sequence Number          : 8
    Failed Auth Attempts    : 0
    Success Auth Attempts   : 0
    Failed Connect Attempts : 0
    Last Successful authentication:

(*) indicates last active.

#show tacacs-server vrf all
    VRF: management
total number of servers:2
Tacacs+ Server               : Tacacs-Server-1/65535 (*)
    Sequence Number          : 7
    Failed Auth Attempts    : 0
    Success Auth Attempts   : 1
    Failed Connect Attempts : 0

```

```
Last Successful authentication: 2018 October 30, 10:10:22
```

```
Tacacs+ Server          : 10.12.17.11/65535
  Sequence Number       : 8
  Failed Auth Attempts  : 0
  Success Auth Attempts : 0
  Failed Connect Attempts : 0
  Last Successful authentication:
```

```
VRF: default
total number of servers:2
```

```
Tacacs+ Server          : Tacacs-Server-1/2222
  Sequence Number       : 7
  Failed Auth Attempts  : 0
  Success Auth Attempts : 0
  Failed Connect Attempts : 0
  Last Successful authentication:
```

```
Tacacs+ Server          : 100.0.0.1/2222
  Sequence Number       : 8
  Failed Auth Attempts  : 0
  Success Auth Attempts : 0
  Failed Connect Attempts : 0
  Last Successful authentication:
```

(*) indicates last active.

```
#show tacacs-server
  VRF: default
total number of servers:2
```

```
Tacacs+ Server          : Tacacs-Server-1/2222
  Sequence Number       : 7
  Failed Auth Attempts  : 0
  Success Auth Attempts : 0
  Failed Connect Attempts : 0
  Last Successful authentication:
```

```
Tacacs+ Server          : 100.0.0.1/2222
  Sequence Number       : 8
  Failed Auth Attempts  : 0
  Success Auth Attempts : 0
  Failed Connect Attempts : 0
  Last Successful authentication:
```

(*) indicates last active.

```
#show tacacs-server vrf management groups G1
  VRF: management
```

```
group G1:
  server Tacacs-Server-1:
    seq-num 7
    port is 65535
    key is *****

  server 10.12.17.11:
    seq-num 8
    port is 65535
    key is *****
```

```
#show tacacs-server vrf all groups G1
  VRF: management
```

```
group G1:
```

```

server Tacacs-Server-1:
seq-num 7
port is 65535
key is *****

server 10.12.17.11:
seq-num 8
port is 65535
key is *****

VRF: default

group G1:
server Tacacs-Server-1:
seq-num 7
port is 2222
key is *****

server 100.0.0.1:
seq-num 8
port is 2222
key is *****

#show tacacs-server groups G1
VRF: default
group G1:
server Tacacs-Server-1:
seq-num 7
port is 2222
key is *****

server 100.0.0.1:
seq-num 8
port is 2222
key is *****

#show tacacs vrf management
VRF: management
total number of servers:2

Tacacs+ Server           : Tacacs-Server-1/65535(*)
  Sequence Number       : 7
  Failed Auth Attempts  : 0
  Success Auth Attempts : 1
  Failed Connect Attempts : 0
  Last Successful authentication: 2018 October 30, 10:10:22

Tacacs+ Server           : 10.12.17.11/65535
  Sequence Number       : 8
  Failed Auth Attempts  : 0
  Success Auth Attempts : 0
  Failed Connect Attempts : 0
  Last Successful authentication:

(*) indicates last active.

#show tacacs vrf all
VRF: management
total number of servers:2

Tacacs+ Server           : Tacacs-Server-1/65535(*)
  Sequence Number       : 7
  Failed Auth Attempts  : 0
  Success Auth Attempts : 1
  Failed Connect Attempts : 0
  Last Successful authentication: 2018 October 30, 10:10:22

Tacacs+ Server           : 10.12.17.11/65535

```



```
Sequence Number      : 8
Failed Auth Attempts : 0
Success Auth Attempts : 0
Failed Connect Attempts : 0
Last Successful authentication:
```

```
VRF: default
total number of servers:2
```

```
Tacacs+ Server      : Tacacs-Server-1/2222 (*)
Sequence Number     : 7
Failed Auth Attempts : 0
Success Auth Attempts : 1
Failed Connect Attempts : 0
Last Successful authentication: 2018 October 30, 10:32:52
```

```
Tacacs+ Server      : 100.0.0.1/2222
Sequence Number     : 8
Failed Auth Attempts : 0
Success Auth Attempts : 0
Failed Connect Attempts : 0
Last Successful authentication:
```

(*) indicates last active.

```
#show tacacs
VRF: default
total number of servers:2
```

```
Tacacs+ Server      : Tacacs-Server-1/2222 (*)
Sequence Number     : 7
Failed Auth Attempts : 0
Success Auth Attempts : 1
Failed Connect Attempts : 0
Last Successful authentication: 2018 October 30, 10:32:52
```

```
Tacacs+ Server      : 100.0.0.1/2222
Sequence Number     : 8
Failed Auth Attempts : 0
Success Auth Attempts : 0
Failed Connect Attempts : 0
Last Successful authentication:
```

(*) indicates last active.

```
#show tacacs vrf management
VRF: management
total number of servers:2
```

```
Tacacs+ Server      : Tacacs-Server-1/65535 (*)
Sequence Number     : 7
Failed Auth Attempts : 0
Success Auth Attempts : 1
Failed Connect Attempts : 0
Last Successful authentication: 2018 October 30, 10:10:22
```

```
Tacacs+ Server      : 10.12.17.11/65535
Sequence Number     : 8
Failed Auth Attempts : 0
Success Auth Attempts : 0
Failed Connect Attempts : 0
Last Successful authentication:
```

(*) indicates last active.

```
#show tacacs vrf all
```

```

VRF: management
total number of servers:2

Tacacs+ Server           : Tacacs-Server-1/65535(*)
  Sequence Number       : 7
  Failed Auth Attempts  : 0
  Success Auth Attempts : 1
  Failed Connect Attempts : 0
  Last Successful authentication: 2018 October 30, 10:10:22

Tacacs+ Server           : 10.12.17.11/65535
  Sequence Number       : 8
  Failed Auth Attempts  : 0
  Success Auth Attempts : 0
  Failed Connect Attempts : 0
  Last Successful authentication:

```

```

VRF: default
total number of servers:2

Tacacs+ Server           : Tacacs-Server-1/2222(*)
  Sequence Number       : 7
  Failed Auth Attempts  : 0
  Success Auth Attempts : 1
  Failed Connect Attempts : 0
  Last Successful authentication: 2018 October 30, 10:32:52

Tacacs+ Server           : 100.0.0.1/2222
  Sequence Number       : 8
  Failed Auth Attempts  : 0
  Success Auth Attempts : 0
  Failed Connect Attempts : 0
  Last Successful authentication:

```

(*) indicates last active.

```

#show tacacs
VRF: default
total number of servers:2

Tacacs+ Server           : Tacacs-Server-1/2222(*)
  Sequence Number       : 7
  Failed Auth Attempts  : 0
  Success Auth Attempts : 1
  Failed Connect Attempts : 0
  Last Successful authentication: 2018 October 30, 10:32:52

Tacacs+ Server           : 100.0.0.1/2222
  Sequence Number       : 8
  Failed Auth Attempts  : 0
  Success Auth Attempts : 0
  Failed Connect Attempts : 0
  Last Successful authentication:

```

(*) indicates last active.

```

#show aaa authentication vrf management
VRF: management
default: group G1
console: local

```

```

#show aaa authentication vrf all
VRF: management
default: group G1
console: local

```

```

    VRF: default
default: group tacacs+
console: local

#show aaa authentication
    VRF: default
default: group tacacs+
console: local

# show aaa groups vrf management
    VRF: management
radius
tacacs+
G1

# show aaa groups vrf all
    VRF: management
radius
tacacs+
G1

    VRF: default
radius
tacacs+
G1

#show aaa groups
    VRF: default
radius
tacacs+
G1

#show running-config tacacs+
feature tacacs+ vrf management
tacacs-server login host Tacacs-Server-1 vrf management seq-num 7 key 7 65535 po
rt 65535
tacacs-server login host 10.12.17.11 vrf management seq-num 8 key 7 65535 port 6
5535

feature tacacs+
tacacs-server login host Tacacs-Server-1 seq-num 7 key 7 65535 port 2222
tacacs-server login host 100.0.0.1 seq-num 8 key 7 65535 port 2222

#show running-config aaa
aaa authentication login default vrf management group G1
aaa group server tacacs+ G1 vrf management
server Tacacs-Server-1 vrf management
server 10.12.17.11 vrf management

aaa authentication login default group tacacs+
aaa group server tacacs+ G1
server Tacacs-Server-1
server 100.0.0.1

#show running-config aaa all
aaa authentication login default vrf management group G1
aaa authentication login console local
aaa accounting default vrf management local
no aaa authentication login default fallback error local vrf management
no aaa authentication login console fallback error local
no aaa authentication login error-enable vrf management
aaa local authentication attempts max-fail 3
aaa local authentication unlock-timeout 1200
aaa group server tacacs+ G1 vrf management
server Tacacs-Server-1 vrf management
server 10.12.17.11 vrf management

aaa authentication login default group tacacs+
```

```

aaa authentication login console local
aaa accounting default local
no aaa authentication login default fallback error local
no aaa authentication login console fallback error local
no aaa authentication login error-enable
aaa local authentication attempts max-fail 3
aaa local authentication unlock-timeout 1200
aaa group server tacacs+ G1
    server Tacacs-Server-1
    server 100.0.0.1

```

TACACS Server Accounting

After authentication, the user can configure accounting to measure the resources that the user consumes during access.

Authenticating Device

<code>#configure terminal</code>	Enter configure mode.
<code>(config)#feature tacacs+ vrf management</code>	Enable the feature TACACS¹ + for vrf management
<code>(config)#feature tacacs+</code>	Enable the feature TACACS+ for default vrf
<code>(config)#tacacs-server login host 10.16.19.2 vrf management seq-num 1 key 0 testing123</code>	Specify the TACACS server IPv4 address to be configured with shared key for vrf management. The same key should be present in the server configuration file.
<code>(config)#tacacs-server login host 10.16.19.2 seq-num 3 key 0 testing123</code>	Specify the TACACS server IPv4 address to be configured with shared key default vrf. The same key should be present in the server configuration file.
<code>(config)#aaa accounting default vrf management group tacacs+</code>	Enable accounting for TACACS server configured for vrf management.
<code>(config)#aaa accounting default group tacacs+</code>	Enable accounting for TACACS server configured for default vrf
<code>(config)#commit</code>	Commit the configuration
<code>(config)#exit</code>	Exit configure mode
<code>#clear tacacs-server counters vrf management</code>	Clear tacacs server counters for management vrf
<code>#clear tacacs-server counters vrf all</code>	Clear tacacs server counters for management and default vrf
<code>#clear tacacs-server counters</code>	Clear tacacs server counters for default vrf

To verify the TACACS accounting process, connect using SSH or Telnet from the host to the client with the user created and provided TACACS server password, and check whether the client validates the user with corresponding username and password.

Validation Commands

show tacacs-server, show aaa accounting, show aaa accounting

¹Terminal Access Controller Access Control System

```
#show aaa accounting vrf management
      VRF: management
      default: group tacacs+
#

#show aaa accounting vrf all
      VRF: management
      default: group tacacs+

      VRF: default
      default: group tacacs+

#show aaa accounting
      VRF: default
      default: group tacacs+
#

#show running-config aaa
aaa authentication login default vrf management group G1
aaa accounting default vrf management group tacacs+
aaa group server tacacs+ G1 vrf management
  server Tacacs-Server-1 vrf management
  server 10.12.17.11 vrf management

aaa authentication login default group tacacs+
aaa accounting default group tacacs+
aaa group server tacacs+ G1
  server Tacacs-Server-1
  server 100.0.0.1
```

Sample TACACS Config File Contents

```
#tacacs configuration file
#set the key

key = "testing123"
accounting file = /var/log/tac_acc.log

user = test1 {
  default service = permit
  login = cleartext "12345"
}

group = netadmin {
  service = ppp protocol = ip {
    priv-lvl = 1
  }
}

user = test2 {
  default service = permit
  login = cleartext "12345"
  member = netadmin
}

user = test3 {
  default service = permit
  login = cleartext "12345"
  service = ppp protocol = ip {
    priv-lvl = 15
  }
}
```

TACACS Server Authorization

Authorization is realized by mapping the authenticated users to one of the existing predefined roles as shown in [Table 9](#).

The privilege information from the **TACACS¹** server is retrieved for the authenticated users and is mapped onto one of the roles as shown in [Table 9](#).

Each authenticated user is mapped to one of the pre-defined privilege level.

Users with priv-level <=0 and priv-level > 15 are treated as read-only user mapped onto the pre-defined network-user role.

There is no command to enable authorization. Authorization functionality is enabled by default when remote authentication is enabled with TACACS+.

Authorization is “auto-enabled”. After successful authentication, a user can enter into privilege exec mode, irrespective of its privilege level and such user is not prompted with enable mode password, if configured. However based on their role, commands are rejected if not allowed to perform certain operations.

Example

A network-user has read-only access and can only execute show commands. A network-user cannot enter configure mode. An error message is displayed upon executing any command which is not allowed.

```
#write
% Access restricted for user %
#configure terminal
% Access restricted for user %
```

The following attribute value pair in TACACS+ server is used to fetch user privilege information.

```
service = ppp protocol = ip {
    priv-lvl = <0..15>
}
```

Sample TACACS+ Configuration File

```
#tacacs configuration file from "tac_plus version F4.0.3.alpha "
#set the key

key = "testing123"
accounting file = /var/log/tac_acc.log

#Read only user "test1", without any priv-lvl, mapped to role "network-user"
user = test1 {
    default service = permit
    login = cleartext "12345"
}

#We can create a group of users mapped to a privilege
group = netadmin {
    service = ppp protocol = ip {
        priv-lvl = 15
    }
}

#User "test2" with highest priv-lvl=15, mapped to role "network-admin"
user = test2 {
```

¹Terminal Access Controller Access Control System

```
default service = permit
login = cleartext "12345"
member = netadmin
}

#User "test3" with priv-lvl= 1..13, mapped to role "network-operator"
user = test3 {
default service = permit
login = cleartext "12345"
service = ppp protocol = ip {
priv-lvl = 10
}
}
#User "test4" with priv-lvl=14, mapped to role "network-engineer" user = test4 {
default service = permit
login = cleartext "12345"
service = ppp protocol = ip {
priv-lvl = 14
}
}
```

Role-Based Access Control

Overview

The **Role-Based Access Control (RBAC)**¹ feature in OcNOS allows the creation of custom user roles locally. This provides administrators with the flexibility to define specific groups of commands that can be allowed or denied for each role. Users can then be assigned to these user roles on a per-switch basis or by utilizing a **TACACS**²+ server.

Feature Characteristics

RBAC offers the capability to restrict or permit users from executing CLI commands in OcNOS and command authorization is entirely handled within OcNOS. With Role-Based Command Authorization, administrators can create the following entities:

- **Policy**³
- **User Role**⁴
- User Name

Policy

A policy is a collection of rules that determine which commands are permitted or denied. The maximum number of policies that can be configured is 20.

User Role

User roles group users together, allowing restrictions to be applied based on the policies associated with the role. When creating a User Role, a default policy should be specified. This default policy determines whether all commands are permitted or denied by default. One or more policies can be attached to a User Role. The maximum number of roles that can be configured is 14.

User Name

Users can be assigned to predefined user roles or customized roles. Some predefined roles include:

- Network-Administrator
- Network-Operator
- Network-Engineer
- Network-User

Multiple users can be assigned the same User Role.

RBAC user accounts will not be deleted when a corresponding RBAC-role is deleted or when the dynamic-RBAC feature is disabled. If an RBAC-user is authenticated but the associated role is not present, the user privilege will

¹A security paradigm that restricts system access based on roles assigned to users.

²Terminal Access Controller Access Control System

³A set of rules determining which actions are permitted or denied for a specific user role.

⁴A predefined or customized grouping of permissions assigned to users.

default to network-user privilege, and the role will be displayed as RBAC-customized-role in the `show users` command.

Benefits

RBAC ensures secure and controlled access to CLI commands, streamlining network management.

Prerequisites

Ensure there is a supported OcNOS router with management interface access.

RBAC Configuration

Here is the example configurations for the RBAC feature. For TACACS+ configurations, see the [TACACS Client Configuration](#) chapter in the System Management guide.



Note: When implemented, users will have visibility into the imposed restrictions through the `show running-config` command. Additionally, both the configured policy and role specifics can be observed using the `show running-config` command.

Example 1

In the provided example, RBAC is employed to define user roles and policies that restrict command access for enhanced security and control. Here is the configuration steps:

```
OcNOS#show running-config rbac
feature dynamic-rbac
policy p1
  permit "enable"
  permit "configure terminal"
  Permit "snmp-server .*"
role custom
default deny-all
add policy p1
```

```
OcNOS#configure terminal
Enter configuration commands, one per line.  End with CNTL/Z.
OcNOS(config)#username test password Test@123
OcNOS(config)#username test role custom
OcNOS(config)#commit
```

```
OcNOS#sh user-account
User:ocnos
roles: network-admin

User:test
roles: custom
```

- The RBAC feature is enabled with the `feature dynamic-rbac` command.
- A policy named `p1` is created, allowing specific commands such as `enable`, `configure terminal`, and `SNMP-related` commands.

- A custom role called **custom** is established, with a default action to deny all commands (**default deny-all**). The previously defined policy **p1** is added to this role.
- A new user account named **test** is created with the password **Test@123**, and the role **custom** is assigned to this user.
- The configuration changes are committed using the **commit** command. The output indicates that the user **test** has the custom role, granting specific permissions.

```

root@debian:~# ssh test@10.12.29.130
test@10.12.29.130's password:
Last login: Tue Aug 23 01:06:31 2022 from 10.12.17.153

OcNOS version DELL_S3048-ON-OcNOS-1.3.9.364-ENT_IPBASE-S0-P0 01/21/2022 15:03:56
OcNOS>en
OcNOS#conf t
Enter configuration commands, one per line. End with CNTL/Z.
OcNOS(config)#snmp-server community test vrf management -->Allowed
OcNOS(config)#ntp server 1.1.1.1 vrf management -->Not Allowed
% Access restricted for user %

```

- The user **test** logs into the system via SSH and demonstrates RBAC enforcement by successfully executing permitted SNMP-related commands but encountering an access restriction when attempting an unauthorized command (**ntp server**).
- This example showcases RBAC in action, illustrating how user roles and policies can control command access based on predefined configurations.

Example 2

In the below example, the user **test1** establishes an SSH connection and demonstrates the RBAC setup. As the default action **permits all** commands except SNMP-related ones, the user is able to execute various configurations, except for **snmp-server** configurations:

```

OcNOS#show running-config rbac
feature dynamic-rbac
policy p1
  permit "enable"
  permit "configure terminal"
  permit "snmp-server ." mode config
policy p2
  permit "enable"
  permit "configure terminal"
  deny "snmp-server ."
role custom-snm
  default permit-all
  add policy p2

```

```

OcNOS#configure terminal
Enter configuration commands, one per line. End with CNTL/Z.
OcNOS(config)#username test1 password Test@1234
OcNOS(config)#username test1 role custom-snm
OcNOS(config)#commit
OcNOS#show user-account
User:ocnos
      roles: network-admin
User:test1
      roles: custom-snm

```

```

root@debian:~# ssh test1@10.12.29.130
test1@10.12.29.130's password:

```

```
OcNOS version DELL_S3048-ON-OcNOS-1.3.9.364-ENT_IPBASE-S0-P0 01/21/2022 15:03:56
OcNOS>enable
OcNOS#configure terminal
Enter configuration commands, one per line. End with CNTL/Z.
OcNOS(config)#ntp server 1.1.1.1 vrf management --> Allowed
OcNOS(config)#snmp-server community test vrf management -->Not Allowed
% Access restricted for user %
```

Implementation Examples

RBAC provides a structured and efficient approach to managing and controlling user access to various resources and functionalities within a system. RBAC is particularly beneficial in scenarios with multiple users with varying levels of permissions and responsibilities. Some common use cases for RBAC include:

Network Security: RBAC enhances network security by restricting users to only the resources and commands they need for their roles, reducing the risk of unauthorized access and potential breaches.

Administrative Efficiency: RBAC simplifies user management by categorizing users into predefined roles and streamlining tasks such as provisioning, access updates, and permissions adjustments.

Regulatory Compliance: RBAC ensures compliance with regulations by enforcing proper access controls and maintaining audit trails, helping organizations meet required standards for data security and privacy.

Reduced Human Error: RBAC minimizes the chance of human errors that could lead to network disruptions or security incidents, as users are limited to the specific commands relevant to their roles.

Access Segmentation: In multi-tenant or multi-customer environments, RBAC facilitates access segmentation, ensuring that different groups can only interact with their designated resources, enhancing isolation and privacy.

RBAC Commands

Here is the compilation of the new commands for configuring RBAC feature. For **TACACS¹** commands, see the [TACACS+ Commands](#) chapter in the System Management guide.

add policy	181
default	182
deny	183
feature dynamic-rbac	184
permit	185
policy	186
role	187
show rbac-policy	188
show rbac-role	189

¹Terminal Access Controller Access Control System

add policy

Use this command to add a policy to a **TACACS**¹ role-based authorization (RBAC) role.

Use the **no** form of this command to remove a policy from an RBAC role.

Command Syntax

```
add policy POLICY-NAME
no add policy POLICY-NAME
```

Parameters

POLICY-NAME

Name of the policy

Default

None

Command Mode

RBAC role mode

Applicability

This command was introduced in OcNOS version 6.4.1.

Examples

The following examples demonstrate the configuration of a role named **'myRole'**, defining its default permissions, adding **'myPolicy1'** to the role, and subsequently removing **'myPolicy2'** from it.

```
OcNOS(config)#role myRole
OcNOS(config-role)#default permit-all
OcNOS(config-role)#add policy myPolicy1
OcNOS(config-role)#no add policy myPolicy2
OcNOS(config-role)#exit
```

¹Terminal Access Controller Access Control System

default

Use this command to set the default rule for a **TACACS**¹ role-based authorization (RBAC) role.

Use the **no** parameter with this command to remove the default rule for a TACACS+ role-based authorization (RBAC) role.

Command Syntax

```
default (permit-all | deny-all)
no default
```

Parameters

permit-all

Permit all commands

deny-all

Deny all commands

Default

Unless this command is explicitly configured, the default rule for a role is **deny-all**.

Command Mode

RBAC role mode

Applicability

This command was introduced in OcNOS version 6.4.1.

Examples

The below example illustrates the configuration of a role named 'myRole' in OcNOS, and specifying its default permission.

```
OcNOS(config)#role myRole
OcNOS(config-role)#default permit-all
OcNOS(config-role)#exit
```

¹Terminal Access Controller Access Control System

deny

Use this command to add a deny rule to a **TACACS**¹ role-based authorization (RBAC) policy. Use the **no** form of this command to remove a deny rule from an RBAC policy.

Command Syntax

```
deny RULE-STRING (mode MODE-NAME |)
no deny RULE-STRING (mode MODE-NAME |)
```

Parameters

RULE-STRING

Command string

MODE-NAME

Command prompt string such as `config-router` or `config-if`. Deny access to the command only in this mode.

Default

None

Command Mode

RBAC policy mode

Applicability

This command was introduced in OcNOS version 6.4.1.

Examples

The example below illustrates the configuration of a policy named `myPolicy` in OcNOS. It includes a deny rule that restricts access to the `ip address` command, specifically within the configuration interface mode (`config-if`).

```
OcNOS#configure terminal
OcNOS(config)#policy myPolicy
OcNOS(config-policy)#deny "ip address" mode config-if
OcNOS(config-policy)#end
```

¹Terminal Access Controller Access Control System

feature dynamic-rbac

Use this command to enable the **TACACS**¹+ role-based authorization (RBAC) feature.

Use the **no** form of this command to disable the RBAC feature.

Command Syntax

```
feature dynamic-rbac
no feature dynamic-rbac
```

Parameters

None

Default

By default, feature TACACS+ RBAC is disabled.

Command Mode

Configure mode

Applicability

This command was introduced in OcNOS version 6.4.1.

Examples

The example below illustrates the configuration of enabling the TACACS+ RBAC feature.

```
OcNOS#configure terminal
OcNOS(config)#feature dynamic-rbac
```

¹Terminal Access Controller Access Control System

permit

Use this command to add a permit rule to a **TACACS**¹ role-based authorization (RBAC) policy.

Use the **no** form of this command to remove a permit rule in an RBAC policy.

Command Syntax

```
permit RULE-STRING (mode MODE-NAME |)
no permit RULE-STRING (mode MODE-NAME |)
```

Parameters

RULE-STRING

Command string

MODE-NAME

Command prompt string such as `config-router` or `config-if`. Permit access to the command only in this mode.

Default

None

Command Mode

RBAC policy mode

Applicability

This command was introduced in OcNOS version 6.4.1.

Examples

The following examples demonstrate the configuration of a policy named **myPolicy**, permitting access to the **ip address** command specifically in the configuration interface mode.

```
OcNOS#configure terminal
OcNOS(config)#policy myPolicy
OcNOS(config-policy)#permit "ip address" mode config-if
```

¹Terminal Access Controller Access Control System

policy

Use this command to create a **TACACS**¹+ role-based authorization (RBAC) policy and enter RBAC policy mode. Use the **no** form of this command to remove an RBAC policy.

Command Syntax

```
policy POLICY-NAME
no policy POLICY-NAME
```

Parameters

POLICY-NAME
Policy² name

Default

None

Command Mode

Configure mode

Applicability

This command was introduced in OcNOS version 6.4.1.

Examples

The following examples demonstrate the configuration of creating the RBAC policy named **myPolicy**, and the command prompt enters the policy configuration mode.

```
OcNOS#configure terminal
OcNOS(config)#policy myPolicy
OcNOS(config-policy)#exit
```

¹Terminal Access Controller Access Control System

²A set of rules determining which actions are permitted or denied for a specific user role.

role

Use this command to create a **TACACS**¹+ role-based authorization (RBAC) role and enter RBAC role mode. Use the **no** form of this command to remove an RBAC role.

Command Syntax

```
role ROLE-NAME
no role ROLE-NAME
```

Parameters

ROLE-NAME

Role name. User cannot specify one of these roles already defined in OcNOS:

```
network-admin
network-user
network-operator
network-engineer
```

For more about these built-in roles, see [username \(page 350\)](#) command.

Default

None

Command Mode

Configure mode

Applicability

This command was introduced in OcNOS version 6.4.1.

Examples

The following examples demonstrate the configuration of creating the RBAC role named **myRole**, with the command prompt entering the role configuration mode.

```
OcNOS#configure terminal
OcNOS(config)#role myRole
OcNOS(config-role)#exit
```

¹Terminal Access Controller Access Control System

show rbac-policy

Use this command to display **TACACS**¹+ role-based authorization (RBAC) policies.

Command Syntax

```
show rbac-policy (POLICY-NAME |)
```

Parameters

POLICY-NAME
Policy² name

Default

None

Command Mode

Execution mode and Privileged execution mode

Applicability

This command was introduced in OcNOS version 6.4.1.

Examples

The following examples display the show output of the RBAC policy named **myPolicy** and its associated configurations.

```
OcNOS#show rbac-policy myPolicy
-----
Policy Name      : myPolicy
permit "ip address" mode config-if
```

¹Terminal Access Controller Access Control System

²A set of rules determining which actions are permitted or denied for a specific user role.

show rbac-role

Use this command to display information about **TACACS**¹+ role-based authorization (RBAC) roles.

Command Syntax

```
show rbac-role (ROLE-NAME |)
```

Parameters

ROLE-NAME
Role name

Default

None

Command Mode

Execution mode and Privileged execution mode

Applicability

This command was introduced in OcNOS version 6.4.1.

Examples

The following examples display the show output of the RBAC role named **myRole** and its associated configurations.

```
OcNOS#show rbac-role myRole
-----
Role Name       : myRole
Default rule    : permit-all
Attached Policies : myPolicy1
                  : myPolicy2
-----
```

Table 10. show rbac-role fields

Entry	Description
Role Name	Displays the name of the role, in this case, myRole .
Default rule	Indicates the default rule associated with the role, which can be permit-all or deny-all .
Attached Policies	Lists the names of policies that are attached to this role. In the example, myPolicy1 and myPolicy2 are attached to myRole .

¹Terminal Access Controller Access Control System

Troubleshooting

For smooth operation, verify accurate sensor path configuration, check encoding method compatibility, and ensure proper router-management system connectivity.

Abbreviations

The following are some key abbreviations and their meanings relevant to this document:

Acronym	Description
RBAC	Role Based Access Control
TACACS ¹	Terminal Access Controller Access Control System
TACACS+	Enhanced version of TACACS

Glossary

The following provides definitions for key terms used throughout this document.

Key Terms	Description
Role-Based Access Control (RBAC) ²	A security paradigm that restricts system access based on roles assigned to users.
User Role ³	A predefined or customized grouping of permissions assigned to users.
Policy ⁴	A set of rules determining which actions are permitted or denied for a specific user role.
Dynamic-RBAC ⁵	Dynamic Role-Based Access Control, allowing role assignment during user authentication.

¹Terminal Access Controller Access Control System

²A security paradigm that restricts system access based on roles assigned to users.

³A predefined or customized grouping of permissions assigned to users.

⁴A set of rules determining which actions are permitted or denied for a specific user role.

⁵Dynamic Role-Based Access Control, allowing role assignment during user authentication.

AUTHENTICATION MANAGEMENT COMMAND REFERENCE

Authentication, Authorization and Accounting	193
aaa authentication login	195
aaa accounting default	196
aaa authentication login default	197
aaa authorization default	199
aaa authentication login console fallback error	200
aaa authentication login default fallback error	201
aaa group server	202
aaa local authentication attempts max-fail	203
aaa local authentication unlock-timeout	204
debug aaa	205
disable default auto-enable	205
server	207
show aaa authentication	208
show aaa authentication login	209
show aaa authorization	210
show aaa groups	211
show aaa accounting	212
show running-config aaa	213
TACACS+ Commands	214
add policy	215
clear tacacs-server counters	216
debug tacacs+	217
default	218
deny	219
feature dynamic-rbac	220
feature tacacs+	221
show debug tacacs+	222
show rbac-policy	223
show rbac-role	224
show running-config tacacs+	225
show tacacs-server	226
tacacs-server login host	228
tacacs-server login key	230
tacacs-server login timeout	231

RADIUS Commands	232
clear radius-server	232
debug radius	233
radius-server login host	234
radius-server login host acct-port	235
radius-server login host auth-port	236
radius-server login host key	237
radius-server login key	239
radius-server login timeout	240
show debug radius	241
show radius-server	242
show running-config radius	243

Authentication, Authorization and Accounting

This chapter is a reference for the authentication:

- Authentication identifies users by challenging them to provide a user name and password. This information can be encrypted if required, depending on the underlying protocol.
- Authorization provides a method of authorizing commands and services on a per user profile basis.



Note: Authorization will be auto-enabled if user enables the Authentication.

- Accounting collects detailed system and command information and stores it on a central server where it can be used for security and quality assurance purposes.

The authentication feature allows you to verify the identity and, grant access to managing devices. The authentication feature works with the access control protocols as described in these chapters:

- [RADIUS Commands \(page 232\)](#)
- [TACACS+ Commands \(page 214\)](#)



Notes: Only network administrators can execute these commands. For more, see the [username \(page 350\)](#) command.

The commands below are supported only on the “management” **VRF**¹.

Per-command authorization needs to be enabled explicitly by the user whereas Session based authorization will be implicitly enabled when user enables authentication.

This chapter describes these commands:

aaa authentication login	195
aaa accounting default	196
aaa authentication login default	197
aaa authorization default	199
aaa authentication login console fallback error	200
aaa authentication login default fallback error	201
aaa group server	202
aaa local authentication attempts max-fail	203
aaa local authentication unlock-timeout	204
debug aaa	205
disable default auto-enable	205
server	207
show aaa authentication	208
show aaa authentication login	209

¹Virtual Routing and Forwarding

show aaa authorization	210
show aaa groups	211
show aaa accounting	212
show running-config aaa	213

aaa authentication login

Use this command to set login authentication behavior.

Use the `no` form of this command to disable either authentication behavior.

Command Syntax

```
aaa authentication login error-enable (vrf (NAME|management)|)
no aaa authentication login error-enable (vrf (NAME|management)|)
```

Parameters

error-enable

Display login failure messages.

vrf management

Defines the management **VRF**¹ instance.

vrf NAME

Specify the user-defined VRF instance name.

Default

By default, aaa authentication login is local

Command Mode

Configure mode

Applicability

This command was introduced before OcNOS version 1.3. Added VRF NAME parameter in OcNOS version 6.5.3.

Examples

```
#configure terminal
(config)#aaa authentication login error-enable vrf management
```

¹Virtual Routing and Forwarding

aaa accounting default

Use this command to set a list of server groups to which to redirect accounting logs.

Use the `no` form of this command to only log locally.

Command Syntax

```
aaa accounting default (vrf (NAME|management)|) ((group LINE)|local)
no aaa accounting default (vrf (NAME|management)|) ((group)|local)
```

Parameters

group

Server group list for authentication

LINE

A space-separated list of up to 8 configured **RADIUS**¹ or **TACACS**²⁺ server group names

local

Use local authentication

vrf management

Defines the management **VRF**³ instance.

vrf NAME

Specify the user-defined VRF instance name.

Default

Default AAA method is local

Default groups: RADIUS or TACACS+

Command Mode

Configure mode

Applicability

This command was introduced before OcNOS version 1.3. Added VRF NAME parameter in OcNOS version 6.5.3.

Examples

```
#configure terminal
(config)#aaa accounting default vrf management group radius
```

¹Remote Authentication Dial-In User Service

²Terminal Access Controller Access Control System

³Virtual Routing and Forwarding

aaa authentication login default

Use this command to set the AAA authentication methods.

Use the **no** form of this command to set the default AAA authentication method (**local**).

Command Syntax

```
aaa authentication login default (vrf (NAME|management)) ((group LINE) | (local (|none)) | (none))
no aaa authentication login default (vrf (NAME|management))((group) | (local (|none)) | (none))
```

Parameters

group

Use a server group list for authentication

LINE

A space-separated list of up to 8 configured **RADIUS**¹ or **TACACS**²⁺, server group names followed by **local** or **none** or both **local** and **none**. The list can also include:

radius

All configured RADIUS servers

tacacs+

All configured TACACS+ servers

local

Use local authentication

none

No authentication

vrf management

Defines the management **VRF**³ instance.

vrf NAME

Specify the user-defined VRF instance name.

Default

By default, AAA authentication method is **local**

By default, groups: **RADIUS** or **TACACS+**

Command Mode

Configure mode

Applicability

This command was introduced before OcNOS version 1.3. Added VRF NAME parameter in OcNOS version 6.5.3.

¹Remote Authentication Dial-In User Service

²Terminal Access Controller Access Control System

³Virtual Routing and Forwarding

Examples

```
#configure terminal  
(config)#aaa authentication login default vrf management group radius
```

aaa authorization default

Use this command to enable per-command authorization. By enabling this user should be able to authorize every command executed via configured server.

This authorization will work only when authentication is successful.

Use the no form of this command to disable authorization.

Command Syntax

```
aaa authorization default (vrf (NAME|management)|) ((group LINE)|local)
no aaa authorization default (vrf (NAME|management)|) ((group LINE)|local)
```

Parameters

group

Server group list for authentication

LINE

Space-separated list of up to 8 configured **TACACS**¹ server group names

local

Use local authentication

vrf management

Defines the management **VRF**² instance.

vrf NAME

Specify the user-defined VRF instance name.

Default

Default AAA method is local

Default groups: TACACS+

Command Mode

Configure mode

Applicability

This command is introduced in OcNOS version 6.1.0. Added VRF NAME parameter in OcNOS version 6.5.3.

Examples

```
#configure terminal
(config)#aaa authorization default vrf management group tacacs+
```

¹Terminal Access Controller Access Control System

²Virtual Routing and Forwarding

aaa authentication login console fallback error

Use this command to enable fallback to local authentication for the console login if remote authentication is configured and all AAA servers are unreachable.

Use the **no** form of this command to disable fallback to local authentication for the console login.

Command Syntax

```
aaa authentication login console fallback error local (vrf (NAME|management) |)  
no aaa authentication login console fallback error local (vrf (NAME|management) |)
```

Parameters

vrf management

Defines the management **VRF**¹ instance.

vrf NAME

Specify the user-defined VRF instance name.

Default

AAA authentication is local.

Command Mode

Configure mode

Applicability

This command was introduced before OcNOS version 1.3. Added VRF NAME parameter in OcNOS version 6.5.3.

Examples

```
#configure terminal  
(config)#aaa authentication login console fallback error local
```

¹Virtual Routing and Forwarding

aaa authentication login default fallback error

Use this command to enable fallback to local authentication for the default login if remote authentication is configured and all AAA servers are unreachable.

Use the **no** form of this command to disable fallback to local authentication.

Command Syntax

```
aaa authentication login default fallback error local (vrf (NAME|management) |)  
no aaa authentication login default fallback error local (vrf (NAME|management) |)
```

Parameters

vrf management

Defines the management **VRF**¹ instance.

vrf NAME

Specify the user-defined VRF instance name.

Default

By default, AAA authentication is local.

Command Mode

Configure mode

Applicability

This command was introduced before OcNOS version 1.3. Added VRF NAME parameter in OcNOS version 6.5.3.

Examples

```
#configure terminal  
(config)#aaa authentication login default fallback error local vrf management
```

¹Virtual Routing and Forwarding

aaa group server

Use this command to create a server group and enter server group configure mode.

Use the `no` form of this command to remove a server group.

Command Syntax

```
aaa group server (radius|tacacs+) WORD (vrf (NAME|management)|)
no aaa group server (radius|tacacs+) WORD (vrf (NAME|management)|)
```

Parameters

radius

RADIUS¹ server group

tacacs+

TACACS²+ server group

WORD

Server group name; maximum 127 characters

vrf management

Defines the management **VRF**³ instance.

vrf NAME

Specify the user-defined VRF instance name.

Default

By default, the AAA group server option is disabled.

Command Mode

Configure mode

Applicability

This command was introduced before OcNOS version 1.3. Added VRF NAME parameter in OcNOS version 6.5.3.

Examples

```
#configure terminal
(config)#aaa group server radius maxsmart
(config-radius)#
```

¹Remote Authentication Dial-In User Service

²Terminal Access Controller Access Control System

³Virtual Routing and Forwarding

aaa local authentication attempts max-fail

Use this command to set the number of unsuccessful authentication attempts before a user is locked out.

Use the `no` form of this command to disable the lockout feature.

Command Syntax

```
aaa local authentication attempts max-fail <1-25>
no aaa local authentication attempts max-fail
```

Parameters

<1-25>

Number of unsuccessful authentication attempts

Default

By default, the maximum number of unsuccessful authentication attempts before a user is locked out is 3.

Command Mode

Configure mode

Applicability

This command was introduced before OcNOS version 1.3.

Examples

```
#configure terminal
(config)#aaa local authentication attempts max-fail 2
```

aaa local authentication unlock-timeout

Use this command to set timeout value in seconds to unlock local user-account.

Use the no form of this command to set default timeout value in seconds.



Note: This command is applicable only to local user but not for user or users present at the server end to authenticate using **TACACS**¹ or **RADIUS**².

Command Syntax

```
aaa local authentication unlock-timeout <1-3600>
no aaa local authentication unlock-timeout
```

Parameters

<1-3600>

Timeout in seconds to unlock local user-account.

Default

By default, the unlock timeout is 1200 seconds.

Command Mode

Configure mode

Applicability

This command was introduced before OcNOS version 1.3.

Examples

```
#configure terminal
(config)#aaa local authentication unlock-timeout 1800
```

¹Terminal Access Controller Access Control System

²Remote Authentication Dial-In User Service

debug aaa

Use this command to display AAA debugging information.

Use the `no` form of this command to stop displaying AAA debugging information.

Command Syntax

```
debug aaa
no debug aaa
```

Parameters

None

Command Mode

Configure mode and Execution mode

Applicability

This command was introduced before OcNOS version 1.3.

Examples

```
#debug aaa
```

disable default auto-enable

Use this command to disable auto-enable feature in remote authentication for user role "network-user".

Use `no` parameter of this command to enable auto-enable feature.

Command Syntax

```
disable default auto-enable
no disable default auto-enable
```

Parameters

None

Command Mode

Configure mode

Applicability

This command was introduced before OcNOS version 6.5.1.

Examples

The following CLI disable auto-enable feature for user role "network-user" in remote authentication.

```
OcNOS (config) #disable default auto-enable  
OcNOS (config) #commit  
OcNOS (config) #exit
```

server

Use this command to add a server to a server group.

Use the `no` form of this command to remove from a server group.

Command Syntax

```
server (A.B.C.D | X:X::X:X | HOSTNAME)
no server (A.B.C.D | X:X::X:X | HOSTNAME)
```

Parameters

A.B.C.D

IPv4 address

X:X::X:X

IPv6 address

HOSTNAME

DNS host name of the server.

Default

None

Command Modes

RADIUS¹ Server Group mode and **TACACS**² Server Group mode

Applicability

This command was introduced before OcNOS version 1.3.

Examples

```
#configure terminal
(config)#feature tacacs+
(config)#aaa group server tacacs+ TacacsGroup4
(config-tacacs)#server 203.0.113.127
```

¹Remote Authentication Dial-In User Service

²Terminal Access Controller Access Control System

show aaa authentication

Use this command to display AAA authentication configuration.

Command Syntax

```
show aaa authentication (vrf (NAME|management) |)
```

Parameters

vrf management

Defines the management VRF¹ instance.

vrf NAME

Specify the user-defined VRF instance name.

Command Modes

Execution mode

Applicability

This command was introduced before OcNOS version 1.3. Added VRF NAME parameter in OcNOS version 6.5.3.

Examples

```
#show aaa authentication
      VRF: default
default: local
console: local
```

The table below explains the output fields.

Table 11. show aaa authentication fields

Field	Description
VRF	Virtual Routing and Forwarding (VRF) default support.
Default	Displays the aaa authentication method list.
Console	Authentication setting for the console access.

¹Virtual Routing and Forwarding

show aaa authentication login

Use this command to display AAA authentication configuration for login default and login console.

Command Syntax

```
show aaa authentication login error-enable (vrf (NAME|management)|)
```

Parameters

error-enable

Display setting for login failure messages

vrf management

Defines the management VRF¹ instance.

vrf NAME

Specify the user-defined VRF instance name.

Command Modes

Execution mode

Applicability

This command was introduced before OcNOS version 1.3. Added VRF NAME parameter in OcNOS version 6.5.3.

Examples

```
#show aaa authentication login error-enable
                                VRF: default
disabled
```

The table below explains the output fields.

Table 12. show aaa authentication login error-enable fields

Field	Description
VRF	Virtual Routing and Forwarding (VRF) default support.

¹Virtual Routing and Forwarding

show aaa authorization

Use this command to display AAA authorization configuration.

Command Syntax

```
show aaa authorization (vrf (NAME|management)|)
```

Parameters

vrf management

Defines the management VRF¹ instance.

vrf NAME

Specify the user-defined VRF instance name.

Command Modes

Execution mode

Applicability

This command is introduced in OcNOS version 6.1.0. Added VRF NAME parameter in OcNOS version 6.5.3.

Examples

```
#show aaa authorization
VRF: default
default: group tacacs+
```

¹Virtual Routing and Forwarding

show aaa groups

Use this command to display AAA group configuration.

Command Syntax

```
show aaa groups (vrf (NAME|management)|)
```

Parameters

vrf management

Defines the management **VRF**¹ instance.

vrf NAME

Specify the user-defined VRF instance name.

Command Modes

Execution mode

Applicability

This command was introduced before OcNOS version 1.3. Added **VRF NAME** parameter in OcNOS version 6.5.3.

Examples

```
#show aaa groups
VRF: default
radius
```

The table below explains the output fields.

Table 13. show aaa groups fields

Field	Description
VRF	Virtual Routing and Forwarding (VRF) default support.

¹Virtual Routing and Forwarding

show aaa accounting

Use this command to display AAA accounting configuration.

Command Syntax

```
show aaa accounting (vrf (NAME|management|all) |)
```

Parameters

vrf all

Accounting configs present in all VRFs.

vrf management

Defines the management VRF¹ instance.

vrf NAME

Specify the user-defined VRF instance name.

Command Modes

Execution mode

Applicability

This command was introduced before OcNOS version 1.3. Added VRF NAME parameter in OcNOS version 6.5.3.

Examples

```
#show aaa accounting
      VRF: default
default: group tacacs+
```

The table below explains the output fields.

Table 14. show aaa accounting fields

Field	Description
VRF	Virtual Routing and Forwarding (VRF) default support.

¹Virtual Routing and Forwarding

show running-config aaa

Use this command to display AAA settings in the running configuration.

Command Syntax

```
show running-config aaa (vrf (NAME|management) |all) |)
```

Parameters

vrf all

All VRFs

vrf management

Defines the management VRF¹ instance.

vrf NAME

Specify the user-defined VRF instance name.

Command Modes

Execution mode

Applicability

This command was introduced before OcNOS version 1.3. Added VRF NAME parameter in OcNOS version 6.5.3.

Examples

```
#show running-config aaa
aaa authentication login default vrf management group tacacs+
aaa group server tacacs+ tac1
server 2.2.2.2 vrf management
```

The table below explains the output fields.

Table 15. show running-config aaa

Field	Description
AAA Authentication	Authentication method used for login.
AAA Group	AAA group for the server.
Server	IP address of the server used for the authentication.
VRF Management	The authentication process for VRF instance.

¹Virtual Routing and Forwarding

TACACS+ Commands

Terminal Access Controller Access-Control System Plus (**TACACS**¹+, usually pronounced like tack-axe) is an access control network protocol for network devices.

The differences between **RADIUS**² and TACACS+ can be summarized as follows:

- RADIUS combines authentication and authorization in a user profile, while TACACS+ provides separate authentication.
- RADIUS encrypts only the password in the access-request packet sent from the client to the server. The remainder of the packet is unencrypted. TACACS+ encrypts the entire body of the packet but leaves a standard TACACS+ header.
- RADIUS uses **UDP**³, while TACACS+ uses TCP.
- RADIUS is based on an open standard (RFC 2865). TACACS+ is proprietary to Cisco, although it is an open, publicly documented protocol (there is no RFC protocol specification for TACACS+).



Notes:

- Only network administrators can execute these commands. For more, see the [username \(page 350\)](#) command.
- The commands below are supported only on the “management” **VRF**⁴.

This chapter contains these commands:

add policy	215
clear tacacs-server counters	216
debug tacacs+	217
default	218
deny	219
feature dynamic-rbac	220
feature tacacs+	221
show debug tacacs+	222
show rbac-policy	223
show rbac-role	224
show running-config tacacs+	225
show tacacs-server	226
tacacs-server login host	228
tacacs-server login key	230
tacacs-server login timeout	231

¹Terminal Access Controller Access Control System

²Remote Authentication Dial-In User Service

³User Datagram Protocol

⁴Virtual Routing and Forwarding

add policy

Use this command to add a policy to a **TACACS**¹+ role-based authorization (RBAC) role.

Use the **no** form of this command to remove a policy from an RBAC role.

Command Syntax

```
add policy POLICY-NAME
no add policy POLICY-NAME
```

Parameters

POLICY-NAME

Name of the policy

Default

None

Command Mode

RBAC role mode

Applicability

This command was introduced in OcNOS version 6.4.1.

Examples

The following examples demonstrate the configuration of a role named **'myRole'**, defining its default permissions, adding **'myPolicy1'** to the role, and subsequently removing **'myPolicy2'** from it.

```
OcNOS(config)#role myRole
OcNOS(config-role)#default permit-all
OcNOS(config-role)#add policy myPolicy1
OcNOS(config-role)#no add policy myPolicy2
OcNOS(config-role)#exit
```

¹Terminal Access Controller Access Control System

clear tacacs-server counters

Use this command to clear the counter on a specified **TACACS**¹ server.

Syntax

```
clear tacacs-server ((HOSTNAME | X:X::X:X | A.B.C.D)|) counters (vrf (management | all)|)
```

Parameters

HOSTNAME

The name of the server

X:X::X:X

IPv6 address of the server

A.B.C.D

IPv4 address of the server

vrf

VRF² of the sever

management

The management VRF

all

All VRFs

Default

None

Command Mode

Execution mode

Applicability

This command was introduced before OcNOS version 1.3.

Example

```
#clear tacacs-server 10.1.1.1 counters
```

¹Terminal Access Controller Access Control System

²Virtual Routing and Forwarding

debug tacacs+

Use this command to display **TACACS**¹ debugging information.

Use the **no** form of this command stop displaying TACACS+ debugging information.

Command Syntax

```
debug tacacs+
no debug tacacs+
```

Parameters

None

Default

None

Command Mode

Execution mode and Configure mode

Applicability

This command was introduced before OcNOS version 1.3.

Examples

```
#debug tacacs+
```

¹Terminal Access Controller Access Control System

default

Use this command to set the default rule for a **TACACS**¹ role-based authorization (RBAC) role.

Use the **no** parameter with this command to remove the default rule for a TACACS+ role-based authorization (RBAC) role.

Command Syntax

```
default (permit-all | deny-all)
no default
```

Parameters

permit-all

Permit all commands

deny-all

Deny all commands

Default

Unless this command is explicitly configured, the default rule for a role is **deny-all**.

Command Mode

RBAC role mode

Applicability

This command was introduced in OcNOS version 6.4.1.

Examples

The below example illustrates the configuration of a role named 'myRole' in OcNOS, and specifying its default permission.

```
OcNOS(config)#role myRole
OcNOS(config-role)#default permit-all
OcNOS(config-role)#exit
```

¹Terminal Access Controller Access Control System

deny

Use this command to add a deny rule to a **TACACS**¹ role-based authorization (RBAC) policy.

Use the **no** form of this command to remove a deny rule from an RBAC policy.

Command Syntax

```
deny RULE-STRING (mode MODE-NAME |)
no deny RULE-STRING (mode MODE-NAME |)
```

Parameters

RULE-STRING

Command string

MODE-NAME

Command prompt string such as `config-router` or `config-if`. Deny access to the command only in this mode.

Default

None

Command Mode

RBAC policy mode

Applicability

This command was introduced in OcNOS version 6.4.1.

Examples

The example below illustrates the configuration of a policy named `myPolicy` in OcNOS. It includes a deny rule that restricts access to the `ip address` command, specifically within the configuration interface mode (`config-if`).

```
OcNOS#configure terminal
OcNOS(config)#policy myPolicy
OcNOS(config-policy)#deny "ip address" mode config-if
OcNOS(config-policy)#end
```

¹Terminal Access Controller Access Control System

feature dynamic-rbac

Use this command to enable the **TACACS¹**+ role-based authorization (RBAC) feature.

Use the **no** form of this command to disable the RBAC feature.

Command Syntax

```
feature dynamic-rbac
no feature dynamic-rbac
```

Parameters

None

Default

By default, feature TACACS+ RBAC is disabled.

Command Mode

Configure mode

Applicability

This command was introduced in OcNOS version 6.4.1.

Examples

The example below illustrates the configuration of enabling the TACACS+ RBAC feature.

```
OcNOS#configure terminal
OcNOS(config)#feature dynamic-rbac
```

¹Terminal Access Controller Access Control System

feature tacacs+

Use this command to enable the **TACACS**¹ feature.

Use the **no** form of this command to disable the TACACS+ feature.

Command Syntax

```
feature tacacs+ (vrf (NAME|management)|)
no feature tacacs+ (vrf (NAME|management)|)
```

Parameters

vrf management

Defines the management **VRF**² instance.

vrf NAME

Specify the user-defined VRF instance name.

Default

None

Command Mode

Configure mode

Applicability

This command was introduced before OcNOS version 1.3. Added **VRF NAME** parameter in OcNOS version 6.5.3.

Examples

```
#configure terminal
(config)#feature tacacs+ vrf management
```

¹Terminal Access Controller Access Control System

²Virtual Routing and Forwarding

show debug tacacs+

Use this command to display whether **TACACS**¹ debugging is enabled.

Command Syntax

```
show debug tacacs+
```

Parameters

None

Command Mode

Execution mode

Applicability

This command was introduced before OcNOS version 1.3.

Examples

```
#show debug tacacs+
TACACS client debugging is on
```

¹Terminal Access Controller Access Control System

show rbac-policy

Use this command to display **TACACS**¹+ role-based authorization (RBAC) policies.

Command Syntax

```
show rbac-policy (POLICY-NAME |)
```

Parameters

POLICY-NAME
Policy² name

Default

None

Command Mode

Execution mode and Privileged execution mode

Applicability

This command was introduced in OcNOS version 6.4.1.

Examples

The following examples display the show output of the RBAC policy named **myPolicy** and its associated configurations.

```
OcNOS#show rbac-policy myPolicy
-----
Policy Name      : myPolicy
permit "ip address" mode config-if
```

¹Terminal Access Controller Access Control System

²A set of rules determining which actions are permitted or denied for a specific user role.

show rbac-role

Use this command to display information about **TACACS**¹+ role-based authorization (RBAC) roles.

Command Syntax

```
show rbac-role (ROLE-NAME |)
```

Parameters

ROLE-NAME
Role name

Default

None

Command Mode

Execution mode and Privileged execution mode

Applicability

This command was introduced in OcNOS version 6.4.1.

Examples

The following examples display the show output of the RBAC role named **myRole** and its associated configurations.

```
OcNOS#show rbac-role myRole
-----
Role Name       : myRole
Default rule    : permit-all
Attached Policies : myPolicy1
                  : myPolicy2
-----
```

Table 16. show rbac-role fields

Entry	Description
Role Name	Displays the name of the role, in this case, myRole .
Default rule	Indicates the default rule associated with the role, which can be permit-all or deny-all .
Attached Policies	Lists the names of policies that are attached to this role. In the example, myPolicy1 and myPolicy2 are attached to myRole .

¹Terminal Access Controller Access Control System

show running-config tacacs+

Use this command to display **TACACS**¹ settings in the running configuration.

Command Syntax

```
show running-config tacacs+
```

Parameters

None

Command Mode

Execution mode

Applicability

This command was introduced before OcNOS version 1.3.

Examples

```
#show running-config tacacs+
feature tacacs+ vrf management
tacacs-server login host 10.16.19.2 vrf management seq-num 1 key 7 0x9f4a8983e0216052
```

[Table 17](#) explains the output fields.

Table 17. show running-config fields

Entry	Description
TACAS server host	TACACS+ server Domain Name Server (DNS) name.
Seq-num	Sequence number of user authentication attempt with the TACACS+ server.
VRF ² Management	The management traffic using VPN Routing and Forwarding (VRFs).

¹Terminal Access Controller Access Control System

²Virtual Routing and Forwarding

show tacacs-server

Use this command to display the TACACS¹+ server configuration.

Command Syntax

```
show tacacs-server ([vrf (management|all)] ((WORD) |(groups (GROUP)|)) |(sorted))
```

Parameters

WORD

DNS host name or IP address

groups

TACACS+ server group

GROUP

Group name; if this parameter is not specified, display all groups

sorted

Sort by TACACS+ server name

vrf

management or all VRFs

Command Mode

Execution mode

Applicability

This command was introduced before OcNOS version 1.3.

Examples

```
#show tacacs-server
total number of servers:1
Tacacs+ Server : 192.168.10.215/49(*)
Sequence Number : 1
Failed Auth Attempts : 0
Success Auth Attempts : 14
Failed Connect Attempts : 0
Last Successful authentication: 2017 December 18, 12:27:13
(*) indicates last active.
```

Here is the explanation of the show command output fields.

Table 18. show tacacs-server output fields

Field	Description
Sequence Number	Sequence number of user authentication attempt with the TACACS+ server.

¹Terminal Access Controller Access Control System

Table 18. show tacacs-server output fields (continued)

Field	Description
Failed Auth Attempts	Number of times user authentication failed with the TACACS+ server. Increments for server key mismatches and password mismatches or wrong password for the user.
Success Auth Attempts	Number of times user authenticated with TACACS+ server. Increments for each successful login.
Failed Connect Attempts	Number of failed TCP socket connections to the TACACS+ server. Increments for server connection failure cases such as server not-reachable, server port mismatches.
Last Successful authentication	Timestamp when user successfully authenticated with the TACACS+ server.

tacacs-server login host

Use this command to set the **TACACS**¹ server host name or IP address.

Use the **no** form of this command to remove an TACACS+ server (if only a host name or IP address is specified as parameter) or to remove all of a TACACS+ server's configuration settings (if any other parameters are also specified).



Notes: When the hostname is configured as a TACACS server, and the local client interface has both IPv4 and IPv6 addresses assigned, the DNS hostname resolution prioritizes the IPv6 address. If the IPv6 address is unreachable, the system does not fall back to the IPv4 address.

Therefore, the user must either:

- Configure only IPv4 or IPv6.

or

- Ensure that the IPv6 address remains reachable.

Command Syntax

```
tacacs-server login host (HOSTNAME | X:X::X:X | A.B.C.D) (vrf management|) (seq-num <1-8> |) (key ((0 WORD) | (7 WORD) | (WORD))) (port <1025-65535> |) (timeout <1-60> |)
no tacacs-server login host (HOSTNAME | A.B.C.D | X:X::X:X) (vrf management|)
no tacacs-server login host (HOSTNAME | X:X::X:X | A.B.C.D) (vrf management|) (key ((0 WORD) | (7 WORD) | (WORD))) (port <1025-65535> |) (timeout <1-60> |)
```

Parameters

HOSTNAME

Host name

X:X::X:X

IPv6 address

A.B.C.D

IPv4 address

vrf

Virtual Routing and Forwarding

management

Management **VRF**²

seq-num

Sequence Number / Priority index for tacacs-servers

key

Authentication and encryption key ("shared secret")

0

Unencrypted (clear text) shared key

WORD

Unencrypted key value; maximum length 63 characters

¹Terminal Access Controller Access Control System

²Virtual Routing and Forwarding

7

Hidden shared key

WORD

Hidden key value; maximum length 512 characters

WORD

Unencrypted (clear text) shared key value; maximum length 63 characters

port

TACACS+ server port

<1205-65535>

TACACS+ server port number; the default is 49

timeout

TACACS+ server timeout

<1-60>

Timeout value in seconds; default is 5 seconds

Default

Enable authentication for TACACS+ server configured. Authorization is also enabled by default. The default server port is 49. The default timeout value is 5 seconds.

There is **no** command to enable authorization. Authorization functionality is enabled by default when remote authentication is enabled with TACACS+.

Command Mode

Configure mode

Applicability

This command was introduced before OcNOS version 1.3.

Examples

```
#configure terminal
(config)#tacacs-server login host 203.0.113.31 vrf management
```

tacacs-server login key

Use this command to set a global preshared key (“shared secret”) which is a text string shared between the device and **TACACS**¹+ servers.

Use the **no** form of this command to remove a global preshared key.

Command Syntax

```
tacacs-server login key ((0 WORD) | (7 WORD) | (WORD)) (vrf management|)
no tacacs-server login key ((0 WORD) | (7 WORD) | (WORD)) (vrf management|)
```

Parameters

0

Unencrypted (clear text) shared key

WORD

Unencrypted key value; maximum length 63 characters

7

Hidden shared key

WORD

Hidden key value; maximum length 512 characters

WORD

Unencrypted (clear text) shared key value; maximum length 63 characters

vrf

Virtual Routing and Forwarding

management

Management **VRF**²

Default

None

Command Mode

Configure mode

Applicability

This command was introduced before OcNOS version 1.3.

Examples

```
#configure terminal
(config)#tacacs-server login key 7 jvn05mlQH1 vrf management
```

¹Terminal Access Controller Access Control System

²Virtual Routing and Forwarding

tacacs-server login timeout

Use this command to set the period to wait for a response from the server before the client declares a timeout failure. The default timeout value is 5 seconds.

You can only give this command when the **TACACS**¹+ feature is enabled.

Use the **no** form of this command to set the timeout value to its default value (5 seconds).



Note: TELNET client session's default timeout is 60 seconds, so configuring timeout of 60 seconds impacts TELNET client applications, because it cannot be fallback to use the other configured server/group. Hence it is recommended to configure 57 seconds or lesser timeout while using TELNET. This timeout doesn't have an impact on SSH connections.

Command Syntax

```
tacacs-server login timeout <1-60> (vrf management|)
no tacacs-server login timeout (vrf management|)
```

Parameters

<1-60>

Timeout value in seconds

vrf

Virtual Routing and Forwarding

management

Management **VRF**²

Default

None

Command Mode

Configure mode

Applicability

This command is introduced in OcNOS version 1.3.9

Examples

```
#configure terminal
(config)#tacacs-server login timeout 35 vrf management
```

¹Terminal Access Controller Access Control System

²Virtual Routing and Forwarding

RADIUS Commands

This chapter is a reference for Remote Authentication Dial In User Service (**RADIUS**¹) commands, RADIUS provides centralized Authentication, Authorization management for users that connect to and use a network service. RADIUS is specified in RFC 2865.



Notes: Only network administrators can execute these commands. For more, see the [username \(page 350\)](#) command.

The commands below are supported only on the “management” **VRF**².

clear radius-server	232
debug radius	233
radius-server login host	234
radius-server login host acct-port	235
radius-server login host auth-port	236
radius-server login host key	237
radius-server login key	239
radius-server login timeout	240
show debug radius	241
show radius-server	242
show running-config radius	243

clear radius-server

Use this command to clear Radius Server statistics.

Command Syntax

```
clear radius-server ((HOSTNAME | X:X::X:X | A.B.C.D)) counters (vrf (management | all))
```

Parameters

A.B.C.D

IPv4 address of **RADIUS**³ server

X:X::X:X

IPv6 address of RADIUS server

HOSTNAME

DNS host name of RADIUS server

¹Remote Authentication Dial-In User Service

²Virtual Routing and Forwarding

³Remote Authentication Dial-In User Service

vrf management

To clear radius server counters for Virtual Routing and Forwarding management

all

To clear radius server counters for both management and default vrf

counters

To clear radius server counters for default vrf

Default

None

Command Mode

Execution mode

Applicability

This command was introduced in OcNOS version 1.3.

Example

```
#clear radius-server counters vrf management
```

debug radius

Use this command to display **RADIUS**¹ debugging information.

Use the **no** form of this command to stop displaying RADIUS debugging information.

Command Syntax

```
debug radius  
no debug radius
```

Parameters

None

Command Mode

Execution mode and Configure mode

Applicability

This command was introduced before OcNOS version 1.3.

Examples

```
#debug radius
```

¹Remote Authentication Dial-In User Service

radius-server login host

Use this command to configure a **RADIUS**¹ server for both accounting and authentication.

Use the **no** form of this command to remove a RADIUS server.

Command Syntax

```
radius-server login host (A.B.C.D | X:X::X:X | HOSTNAME) (vrf management|) seq-num (<1-8>)
radius-server login host (A.B.C.D | X:X::X:X | HOSTNAME) (vrf management|) seq-num (<1-8>) timeout
<1-60>
radius-server login host (A.B.C.D | X:X::X:X | HOSTNAME) (vrf management|) seq-num (<1-8>) (acct-port
<0-65535> |) | timeout <1-60> |)
radius-server login host (A.B.C.D | X:X::X:X | HOSTNAME) (vrf management|) seq-num (<1-8>) (| (auth-
port <0-65535> |) (acct-port <0-65535> |) (timeout <1-60>)))))
radius-server login host (A.B.C.D | X:X::X:X | HOSTNAME) (vrf management|) seq-num (<1-8>) (| (key ((0
WORD) | (7 WORD)) |) (auth-port <0-65535> |) (acctport <0-65535> |) (timeout <1-60>)))))

no radius-server login host (A.B.C.D | X:X::X:X | HOSTNAME) (vrf management|) (seq-num (<1-8>)|)
no radius-server login host (A.B.C.D | X:X::X:X | HOSTNAME) (vrf management|) (seq-num (<1-8>)|)
timeout
```

Parameters

login

Remote login

A.B.C.D

IPv4 address of RADIUS server

X:X::X:X

IPv6 address of RADIUS server

HOSTNAME

DNS host name of RADIUS server

seq-num

seq-num Sequence Number / Priority index for radius-servers

<1-8>

sequence number for servers

timeout

How long to wait for a response from the RADIUS server before declaring a timeout failure

<1-60>

Range of time out period in seconds

vrf

Virtual Routing and Forwarding

management

Management **VRF**²

Default

None

¹Remote Authentication Dial-In User Service

²Virtual Routing and Forwarding

Command Mode

Configure mode

Applicability

This command was introduced before OcNOS version 1.3.

Examples

```
#configure terminal
(config)#radius-server login host 203.0.113.15 vrf management seq-num 1
```

radius-server login host acct-port

Use this command to configure a **RADIUS**¹ server and specify a **UDP**² port to use for RADIUS accounting messages.

Use the **no** form of this command to remove a RADIUS server.

Command Syntax

```
radius-server login host (A.B.C.D | X:X::X:X | HOSTNAME) (vrf management|) (seq-num (<1-8>)|) acct-
port <0-65535> |) | timeout <1-60> |)
no radius-server login host (A.B.C.D | X:X::X:X | HOSTNAME) (vrf management|) (seq-num (<1-8>)|)
acct-port |) | timeout <1-60> |)
```

Parameters

login

Remote login

A.B.C.D

IPv4 address of RADIUS server

X:X::X:X

IPv6 address of RADIUS server

HOSTNAME

DNS host name of RADIUS server

seq-num

seq-num Sequence Number / Priority index for radius-servers

<1-8>

sequence number for servers

acct-port

UDP port to use for RADIUS accounting messages

<0-65535>

Range of UDP port numbers

timeout

How long to wait for a response from the RADIUS server before declaring a timeout failure

¹Remote Authentication Dial-In User Service

²User Datagram Protocol

<1-60>

Range of timeout period in seconds

vrf

Virtual Routing and Forwarding

managementManagement VRF¹**Default**

By default, Radius-server login host acct-port is 1813

Command Mode

Configure mode

Applicability

This command was introduced before OcNOS version 1.3.

Examples

```
#configure terminal
(config)#radius-server login host 192.168.2.3 vrf management seq-num 2 acct-port 23255
```

radius-server login host auth-port

Use this command to configure a **RADIUS**² server and specify a **UDP**³ port to use for RADIUS authentication messages.

Use the **no** form of this command to remove a RADIUS server.

Command Syntax

```
radius-server login host (A.B.C.D | X:X::X:X | HOSTNAME) (vrf management|) (seq-num (<1-8>)|) (|
(auth-port <0-65535> |(acct-port <0-65535> |(timeout <1-60>))))))
no radius-server login host (A.B.C.D | X:X::X:X | HOSTNAME) (vrf management|) (seq-num (<1-8>)|)
(auth-port |(acct-port |(timeout))))
```

Parameters**login**

Remote login

A.B.C.D

IPv4 address of RADIUS server

X:X::X:X

IPv6 address of RADIUS server

¹Virtual Routing and Forwarding²Remote Authentication Dial-In User Service³User Datagram Protocol

HOSTNAME

DNS host name of RADIUS server

seq-num

seq-num Sequence Number / Priority index for radius-servers

<1-8>

sequence number for servers

auth-port

UDP port to use for RADIUS accounting messages

<0-65535>

Range of UDP port numbers

acct-port

UDP port to use for RADIUS accounting messages

<0-65535>

Range of UDP port numbers

timeout

How long to wait for a response from the RADIUS server before declaring a timeout failure

<1-60>

Range of timeout period in seconds

vrf

Virtual Routing and Forwarding

management

Management VRF¹

Default

By default, Radius-server login host acct-port is 1812.

Command Mode

Configure mode

Applicability

This command was introduced before OcNOS version 1.3.

Examples

```
#configure terminal
(config)#radius-server login host 203.0.113.15 vrf management seq-num 1 auth-port 23255
```

radius-server login host key

Use this command to set per-server shared key (“shared secret”) which is a text string shared between the device and **RADIUS**² servers.

Use the no form of this command to remove a server shared key.

¹Virtual Routing and Forwarding

²Remote Authentication Dial-In User Service

Command Syntax

```
radius-server login host (A.B.C.D | X:X::X:X | HOSTNAME) (vrf management|) (seq-num (<1-8>|) (|(key
(0 WORD) | (7 WORD)) (|(auth-port <0-65535> (|(acct-port <0-65535> (|(timeout <1-60>))))))))))
no radius-server login host (A.B.C.D | X:X::X:X | HOSTNAME) (vrf management|) (seq-num (<1-8>|) (key
(0 WORD) | (7 WORD) ) (|(auth-port <0-65535> (|(acct-port (|(timeout))))))))))
```

Parameters

login

Remote login

A.B.C.D

IPv4 address of RADIUS server

X:X::X:X

IPv6 address of RADIUS server

HOSTNAME

DNS host name of RADIUS server

seq-num

seq-num Sequence Number / Priority index for radius-servers

<1-8>

sequence number for servers

0

Unencrypted (clear text) shared key

WORD

Unencrypted key value; maximum length 63 characters

7

Hidden shared key

WORD

Hidden key value; maximum length 63 characters

WORD

Unencrypted (clear text) shared key value; maximum length 63 characters

auth-port

UDP¹ port to use for RADIUS accounting messages

<0-65535>

Range of UDP port numbers

acct-port

UDP port to use for RADIUS accounting messages

<0-65535>

Range of UDP port numbers

timeout

How long to wait for a response from the RADIUS server before declaring a timeout failure

<1-60>

Range of timeout period in seconds

vrf

Virtual Routing and Forwarding

¹User Datagram Protocol

management
Management VRF¹

Default

None

Command Mode

Configure mode

Applicability

This command was introduced before OcNOS version 1.3.

Examples

```
#configure terminal
(config)#radius-server login host 203.0.113.15 vrf management seq-num 1 key 0 testing auth-port 23255
```

radius-server login key

Use this command to set a global preshared key (“shared secret”) which is a text string shared between the device and **RADIUS**² servers.

Use the **no** form of this command to remove a global preshared key.

Command Syntax

```
radius-server login key ((0 WORD) | (7 WORD)) (vrf management|)
radius-server login host (A.B.C.D | X:X::X:X | HOSTNAME) (vrf management|) (seq-num
(<1-8>|) (|key ((0 WORD) | (7 WORD)) (|auth-port <0-65535> (|acctport <0-65535> (|timeout <1-
60>))))))
no radius-server login key ((0 WORD) | (7 WORD)) (vrf management|)
no radius-server login host (A.B.C.D | X:X::X:X | HOSTNAME) (vrf management|) (seqnum(<1-8>|) (key ((0
WORD) | (7 WORD)) (|auth-port <0-65535> (|acctport(|timeout))))))
```

Parameters

login

Remote login

0

Unencrypted (clear text) shared key

WORD

Unencrypted key value; maximum length 63 characters

7

Hidden shared key

WORD

Hidden key value; maximum length 63 characters

¹Virtual Routing and Forwarding

²Remote Authentication Dial-In User Service

WORD

Unencrypted (clear text) shared key value; maximum length 63 characters

vrf

Virtual Routing and Forwarding

management

Management VRF¹

Default

None

Command Mode

Configure mode

Applicability

This command was introduced before OcNOS version 1.3.

Examples

```
#configure terminal
(config)#radius-server login key 7 p2AcxlQA vrf management

#configure terminal
(config)#no radius-server login key 7 p2AcxlQA vrf management
```

radius-server login timeout

Use this command to set the global timeout which is how long the device waits for a response from a **RADIUS**² server before declaring a timeout failure.

Use the **no** form of this command to set the global timeout to its default (1 second).



Note: TELNET client session's default timeout is 60 seconds, so configuring timeout of 60 seconds impacts TELNET client applications, because it cannot be fallback to use the other configured server/group. Hence it is recommended to configure 57 seconds or lesser timeout while using TELNET. This timeout doesn't have an impact on SSH connections.

Command Syntax

```
radius-server login timeout <1-60> (vrf management|)
no radius-server login timeout (vrf management|)
```

Parameters**login**

Remote login

¹Virtual Routing and Forwarding

²Remote Authentication Dial-In User Service

<1-60>

Range of timeout period in seconds

vrf

Virtual Routing and Forwarding

management

Management VRF¹



Note: The system takes minimum 3 secs to timeout even though the configured timeout value is less than 3 seconds. Hence do not configure timeout value less than 3 secs. The timeout range value is mentioned as 1-60 secs for backward compatibility.

Default

By default, radius-server login timeout is 5 seconds

Command Mode

Configure mode

Applicability

This command was introduced before OcNOS version 1.3.

Examples

```
#configure terminal
(config)#radius-server login timeout 15 vrf management

#configure terminal
(config)#no radius-server login timeout 15 vrf management
```

show debug radius

Use this command to display debugging information.

Command Syntax

```
show debug radius
```

Parameters

None

Command Mode

Execution mode

¹Virtual Routing and Forwarding

Applicability

This command was introduced before OcNOS version 1.3.

Examples

```
#show debug radius
RADIUS client debugging is on
```

show radius-server

Use this command to display the **RADIUS**¹ server configuration.

Command Syntax

```
show radius-server (|vrf(management|all)) ((WORD)|(groups (GROUP|)|)|sorted
```

Parameters

WORD

DNS host name or IP address

groups

RADIUS server group

GROUP

Group name; if this parameter is not specified, display all groups

sorted

Sort by RADIUS server name

vrf

management or all VRFs

Command Mode

Execution mode

Applicability

This command was introduced before OcNOS version 1.3.

Examples

```
#show radius-server vrf management
  VRF: management
timeout value: 5
Total number of servers:2
Following RADIUS servers are configured:
Radius Server      : 10.12.12.39
  Sequence Number  : 1
  available for authentication on port : 1812
  available for accounting on port    : 1813
  RADIUS shared secret : *****
```

¹Remote Authentication Dial-In User Service

```

Failed Authentication count      : 0
Successful Authentication count  : 0
Failed Connection Request       : 0
Last Successful authentication   :
Radius Server                    : 1.1.1.1
Sequence Number                 : 2
available for authentication on port : 1234
available for accounting on port   : 1234
timeout                          : 5
Failed Authentication count      : 0
Successful Authentication count  : 0
Failed Connection Request       : 0
Last Successful authentication   :

```

Here is the explanation of the "show radius-server fields" output fields.

Table 19. show radius-server fields

Entry	Description
VRF ¹	Virtual Routing and Forwarding (VRF) default support.
Timeout Value	Period the local router waits to receive a response from a RADIUS accounting server before retransmitting the message
Total number of servers	Number of authentication requests received by the authentication server.

show running-config radius

Use this command to display **RADIUS**² configuration settings in the running configuration.

Command Syntax

```
show running-config radius
```

Parameters

None

Command Mode

Execution mode

Applicability

This command was introduced before OcNOS version 1.3.

Examples

```

#show running-config radius
 10.12.12.39 vrf management seq-num 1 key 7 wawyanb123
 1.1.1.1 vrf management seq-num 2 auth-port 1234 acct-po
rt 1234
radius-server login key 7 wawyanb123

```

¹Virtual Routing and Forwarding

²Remote Authentication Dial-In User Service

REMOTE DEVICE CONNECT CONFIGURATION

Telnet Configuration	245
Overview	245
In-band Management Over Default VRF	245
In-band Management Over User Defined VRF	248
SSH Client Server Configuration	251
Overview	251
SSH Configuration	251
SSH Encryption Cipher	254
SSH Key-Based Authentication	258
Max Session and Session Limit Configuration	263
Overview	263
Topology	263
Configuration of SSH Server Session Limit Lesser than Max-Session	264
Configuration of Telnet Session Limit Greater than Max-Session	265
Configuration of SSH Session Limit Greater than Max-Session	266

Telnet Configuration

Overview

Telnet is a TCP/IP protocol used on the Internet and local area networks to provide a bidirectional interactive text-oriented communications facility using a virtual terminal connection. The Telnet program runs, connects it to a server on the network. A user can then enter commands through the Telnet program and they will be executed as if the user were entering them directly on the server console. Telnet enables users to control the server and communicate with other servers on the network. The default port number for Telnet protocol is 23. Telnet offers users the capability of running programs remotely and facilitates remote administration.

In-band Management Over Default VRF

OcNOS supports Telnet over the default and management VRFs via in-band management interface and OOB management interface, respectively.

By default, Telnet runs on the management VRF¹.

Telnet Configuration with IPv4 Address

Topology

Figure 6. Telnet topology



Enable and Disable the Telnet Server

<code>#configure terminal</code>	Enter configure mode
<code>(config)#no feature telnet vrf management</code>	Disable Telnet feature
<code>(config)#feature telnet vrf management</code>	Enable Telnet feature
<code>(config)#commit</code>	Commit the candidate configuration to the running configuration

¹Virtual Routing and Forwarding

(config)#exit	Exit configure mode
---------------	---------------------

Configure the Telnet Server Port

#configure terminal	Enter configure mode
(config)#no feature telnet vrf management	Disable Telnet feature
(config)#telnet server port 6112 vrf management	Set Telnet port to 6112
(config)#feature telnet vrf management	Enable Telnet feature
(config)#commit	Commit the candidate configuration to the running configuration
(config)#exit	Exit configure mode

Telnet Client Session

#telnet 10.10.10.1 vrf management	Log into remote machine using IPv4 address
-----------------------------------	--

Validation

```
#show telnet server

VRF MANAGEMENT
telnet server enabled port: 23
VRF DEFAULT:
telnet server enabled port: 6112

#show running-config telnet server

feature telnet vrf management
no feature telnet
```

Telnet Configuration with IPv6 Address

Telnet is performed with IPv6 IP and verified by logging on remote PC.

Topology

The sample configuration of Telnet is:

Figure 7. Telnet Configuration topology



Basic Configuration

#configure terminal	Enter configure mode
(config)#no feature telnet vrf management	Disable Telnet feature
(config)#feature telnet vrf management	Enable Telnet feature
(config)#commit	Commit the candidate configuration to the running configuration
(config)#exit	Exit configure mode

Configure the Telnet Server Port

#configure terminal	Enter configure mode
(config)#no feature telnet vrf management	Disable Telnet feature
(config)#telnet server port 6112 vrf management	Set Telnet port to 6112
(config)#feature telnet vrf management	Enable Telnet feature
(config)#commit	Commit the candidate configuration to the running configuration
(config)#exit	Exit configure mode

Telnet Client Session

#telnet 2001::1 vrf management	Log into remote machine using IPv6 address
--------------------------------	--

Validation

```
##show telnet server

VRF MANAGEMENT
telnet server enabled port: 23

VRF DEFAULT:
telnet server enabled port: 6112
```

```
#show running-config telnet server

feature telnet vrf management
no feature telnet
```

In-band Management Over User Defined VRF

From release 6.5.3, OcNOS supports Telnet over the user defined vrf as well along with default and management VRFs via in-band interface.

By default, Telnet runs on the management VRF. If user wants to enable telnet feature over user defined vrf which can be part of MPLS L3VPN/EVPN, it is possible to enable telnet feature over those user defined vrf.

User must able to enable telnet feature over multiple user defined vrf simultaneously with default/non default telnet ports.

Telnet Configuration with IPv4 Address

Topology

Figure 8. Telnet Configuration topology

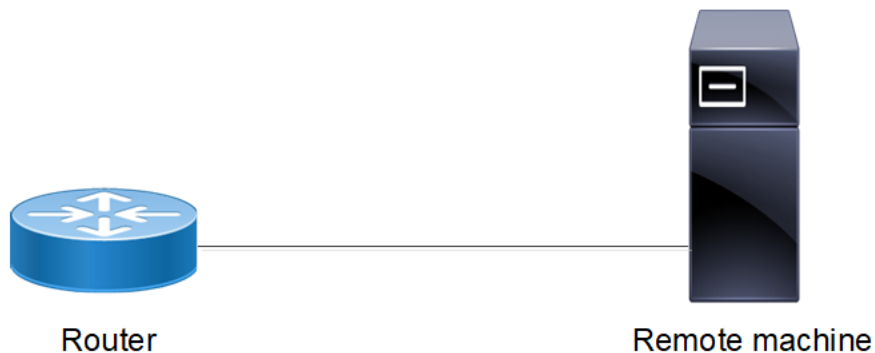

Enable and Disable the Telnet Server on user defined vrf say vrf name is vrf_test

#configure terminal	Enter configure mode
(config)#no feature telnet vrf vrf_test	Disable Telnet feature
(config)#feature telnet vrf vrf_test	Enable Telnet feature
(config)#commit	Commit the candidate configuration to the running configuration
(config)#exit	Exit configure mode

Configure the Telnet Server Port on user defined vrf say vrf name is vrf_test

#configure terminal	Enter configure mode
(config)#ip vrf vrf_test	Configure User defined vrf
(config)#no feature telnet vrf vrf_test	Disable Telnet feature

<code>(config)#telnet server port 6112 vrf vrf_test</code>	Set Telnet port to 61112
<code>(config)#feature telnet vrf vrf_test</code>	Enable Telnet feature
<code>(config)#commit</code>	Commit the candidate configuration to the running configuration
<code>(config)#exit</code>	Exit configure mode

Telnet Client Session

<code>#telnet 10.10.10.1</code>	Log into remote machine using IPv4 address
---------------------------------	--

Validation

```
#show telnet server

VRF MANAGEMENT
telnet server enabled port: 23 VRF DEFAULT:
telnet server enabled port: 23
VRF vrf_test:
telnet server enabled port: 6112

#show running-config telnet server
feature telnet vrf vrf_test
feature telnet vrf management
feature telnet
```

Telnet Configuration with IPv6 Address

Telnet is performed with IPv6 IP and verified by logging on remote PC.

Topology

Figure 9. Telnet Configuration topology

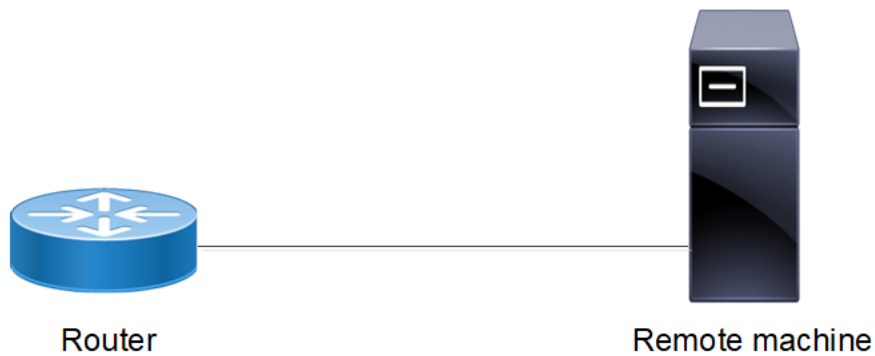

Basic Configuration

<code>#configure terminal</code>	Enter configure mode
<code>(config)#ip vrf vrf_test</code>	Configure User defined vrf
<code>(config)#no feature telnet vrf vrf_test</code>	Disable Telnet feature
<code>(config)#feature telnet vrf vrf_test</code>	Enable Telnet feature

<code>(config)#commit</code>	Commit the candidate configuration to the running configuration
<code>(config)#exit</code>	Exit configure mode

Configure the Telnet Server Port

<code>#configure terminal</code>	Enter configure mode
<code>(config)#no feature telnet vrf vrf_test</code>	Disable Telnet feature
<code>(config)#telnet server port 6112 vrf vrf_test</code>	Set Telnet port to 6112
<code>(config)#feature telnet vrf vrf_test</code>	Enable Telnet feature
<code>(config)#commit</code>	Commit the candidate configuration to the running configuration
<code>(config)#exit</code>	Exit configure mode

Telnet Client Session

<code>#telnet 2001::1</code>	Log into remote machine using IPv6 address
------------------------------	--

Validation

```
#show telnet server
VRF MANAGEMENT
telnet server enabled port: 23 VRF DEFAULT:
telnet server enabled port: 23
VRF vrf_test:
telnet server enabled port: 6112

#show running-config telnet server
feature telnet vrf vrf_test
feature telnet vrf management
feature telnet
```

SSH Client Server Configuration

Overview

SSH is a network protocol that allows data to be exchanged using a secure channel between two networked devices. SSH was designed as a replacement for Telnet and other insecure remote shells, which send information, notably passwords, in plain text, rendering them susceptible to packet analysis.[2] The encryption used by SSH is intended to provide confidentiality and integrity of data over an unsecured network, such as the Internet. SSH uses public-key cryptography to authenticate the remote computer and allow the remote computer to authenticate the user.

SSH is typically used to log into a remote machine and execute commands, but it also supports tunneling, forwarding TCP ports and X11 connections; it can transfer files using the associated SFTP or SCP protocols. SSH uses the client- server model

TCP port 22 is assigned for contacting SSH servers. This document covers the SSH server configuration to enable SSH service and key generation and SSH client configuration for remote login to server.

In-band Management over Default VRF

OcNOS supports SSH over the default and management VRFs via the in-band management interface and out-of-band management interfaces, respectively.

SSH can run on the default and management VRFs simultaneously. By default, it runs on the management **VRF**¹.

SSH Configuration

SSH is performed with IPv4 and IPv6 addresses.

IPv4 Address Configuration

Topology

Figure 10. SSH sample topology



¹Virtual Routing and Forwarding

Basic Configuration

#configure terminal	Enter configure mode
(config)#ssh login-attempts 2 vrf management	Set the number of login attempts to 2
(config)#commit	Commit the candidate configuration to the running configuration
(config)#exit	Exit configure mode

Validation

```
#show ssh server
ssh server enabled port: 22
authentication-retries 2

#show running-config ssh server
feature ssh vrf management
ssh login-attempts 2 vrf management
```

SSH Client Session

When the device acts as an SSH client, it supports both SSH IPv4 sessions to log into the remote machine.

#ssh root@10.10.10.1 vrf management	Log into remote machine using an IPv4 address
-------------------------------------	---

SSH Keys

Use the ssh key command to generate new RSA/DSA keys for the SSH server. By default, the system has RSA/DSA public/private key pair placed in `/etc/ssh/`. If you want to regenerate RSA keys, you must specify the `force` option.

Configuration

#ssh keygen host rsa vrf management	Specify the <code>force</code> option to regenerate SSH RSA keys. This option overwrites the existing key.
-------------------------------------	--

Validation

```
#sh ssh key
*****RSA KEY*****
ssh-rsa
AAAAB3NzaC1yc2EAAAADAQABAAQDMuVc0jpnGmYnZaqzIELX6LlsaK/1q7pBixmwHAGDsZm/dClTLb18AIB27W68YD8k0
+Yw0LR0rHuPtNeSFMEsMaQxsaLkSi7yg86xSJaqqLQTyOUTS/OC9hreXk73ay
n0yXa8+bre0oyJq1NWxAI9BljEhfSSAipoDSp/dmc93VJyV+3hgy1FMTAheyebQaUVElBEMH7sir1Sfyo7OHsBYSF6GzAmSu
Cm6PAelPm/3L4gChcnPL+0outQOifCSLdUOXEZhTFXrzC611+14LgT8pR6YN+2uEnU6kq1i
aDLEffIWk4dWcP67JUief1BTOvxRurpssuRds1hJQXDFaj
bitcount: 2048 fingerprint: a4:23:5d:8a:5a:54:8b:3e:0b:38:06:79:82:e9:83:48
*****
*****DSA KEY*****
ssh-dsa
AAAAB3NzaC1kc3MAAACBALpY6MFhFPYI+VcAHzHppnwVnNXv9oR/EGHUM50BBqdQE1Qilmlt1rft4oa4tYR46P4gazKnnNfV
E/97FwEbCZaXaz9Wzfcfa3ALtsgdyNQQk2BebYiRnmeWnS3wGV0M/D64bAiV0
2p/LyF6D0ygMnZ3up3ttTN5QfHeyYQtwyzAAAAFQD+k6wQyr51IhXIQSsQD8by8qxjUwAAAIB0LxP3l1jnfzxEXyEkNNzLxCc
J7ZzkFYUmtDJxRZ1DceuSf4QipMrQVrdrgdqZNhrUiDWM/HaCM09LdEQxfPh5TaIwPycngn
VUS83Tx577ofBW6hellTey3B3/3I+FfiGKUXS/mZSyf5FW3swwyZwMkF0mV0SRCYTprnFt5qx8awAAAIeAjDNqMkyUvB6JB
qfo7zbGqXjBQmJ+dE8fgjI2znlqg4lhYcMZJVNTiydIgmVNFfKc1dAT3zr6qMZfGv56EbK
1qUu103K5CF44XfVkyNcHJV+/fcfAJasGU8W6oSbU5Q08abyMsIGRYTurOMkRhviF6sxvieEpVnVK2/nPVVXA=
bitcount: 1024 fingerprint: d9:7a:80:e0:76:48:20:72:a6:5b:1c:67:da:91:9f:52
```

 **Note:** The newly created rsa/dsa key can be verified by logging into the device from a remote machine and checking whether the newly created key's fingerprint matches with the logging session fingerprint.

IPv6 Address Configuration

SSH is performed with IPv6 IP and verified by logging in on remote PC.

Topology

[Figure 11](#) shows the sample configuration of SSH.

Figure 11. SSH Configuration topology

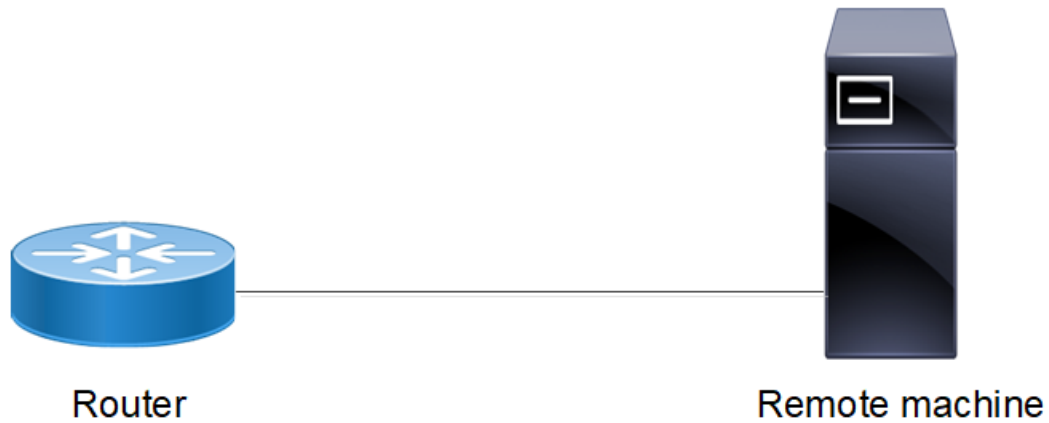

DUT

#configure terminal	Enter configure mode
(config)#ssh login-attempts 2 vrf management	Set the number of login attempts to 2
(config)#commit	Commit the candidate configuration to the running configuration
(config)#exit	Exit configure mode

Validation

```
#show ssh server ssh server
ssh server enabled port: 22
authentication-retries 2

#show running-config ssh server
feature ssh vrf management
ssh login-attempts 2 vrf management
```

SSH Client Session

When the device acts as an SSH client, it supports both SSH IPv6 sessions to log into the remote machine.

#ssh root@2001::1 vrf management	Log into remote machine using an IPv6 address
----------------------------------	---

SSH Keys

Use the SSH key command to generate new RSA/DSA keys for the SSH server. By default, the system has RSA/DSA public/private key pair placed in `/etc/ssh/`. If you want to regenerate RSA keys, you must specify the `force` option.

#ssh keygen host rsa vrf management	Specify the <code>force</code> option to regenerate SSH RSA keys. This option overwrites the existing key.
-------------------------------------	--

Validation

```
#sh ssh key *****RSA KEY*****
ssh-rsa AAAAB3NzaC1yc2EAAAADAQABAAQDMuVc0jpnNgMyNzaqzIELX6LlsaK/ 1q7pBixmwHAGDsZm/
dClTLb18AIB27W68YD8k0+Yw0LR0rHuPtNeSFMEsMaQxsaLkSi7yg86xSJaqgLTyOUTS/ OC9hreXkJ73ay
n0yXa8+bre0oyJq1NWxAI9BljEhfSSAipoDsp/
dmc93VJyV+3hgy1FMTAheyebQaUvELBEMH7siRLSfyo7OHsBYSF6GzAmSuCm6PAelpHm/
3L4gChcnPL+0outQOifCSLdUOXEZHTFXrzC611+14Lgt8pR6YN+2uEnU6kqli
aDLEffIWK4dWcp67JUief1BTOvxRurpssuRdshlJQXDFaj bitcount: 2048 fingerprint:
a4:23:5d:8a:5a:54:8b:3e:0b:38:06:79:82:e9:83:48 *****
*****DSA KEY*****
ssh-dsa AAAAB3NzaC1kc3MAAACBALpY6MfHFPYI+VcAHZHpnpwVnNXv9oR/
EGHUM50BBqdQE1Qilmlt1rft4oa4tYR46P4gazKnnNfVE/
97FwEbCZaXaz9Wzfcfa3ALtsvGdyNQqk2BebYiRnmeWnS3wGV0M/D64bAiV0 2p/
LyF6D0ygMnZ3up3ttTN5QfHeyYQtwyzAAAAFQD+k6wQyr51IhXIQSSQD8by8qxjUwAAATB0LxP31jn
fzxEXyEkNNz1xCcJ7ZzkFYUmtDJxRZ1Dceusf4QipMrQVrdrgdqZNhrUiDWM/ HaCM09LdEQxfPh5TaIwPycngn
VUS83Tx577ofBW6hellTey3B3/3I+FfiGKUXS/
mZSyf5FW3swwyZwMkF0mV0SRCYTprnFt5qx8awAAAEIAEjDNqMkyxUvB6JBqfo7zbGqXjBQmJ+dE8fg
jI2znlqg41hYcMZJVNWtIydDIgMVNFfKc1dAT3zr6qMZfGv56EbKlqUu103K5CF44XfvkYNchJV+/
fcfAJasGU8W6oSbU5Q08abyMsIGRYTurOMkRhvif6sxvieEpVnVK2/nPVVXA= bitcount: 1024 fingerprint:
d9:7a:80:e0:76:48:20:72:a6:5b:1c:67:da:91:9f:52 *****
```

SSH Encryption Cipher

Overview

The Secure Shell (SSH) management uses various algorithms in the security mechanisms such as key exchange (KEX), message authentication code (MAC), and encryption (Cipher) for security and flexibility. As part of the security enhancement, additional SSH management algorithms are added into KEX, MAC, and encryption methods.

The security encryption algorithms used in SSH are enhanced to enable the users to use preferable (including weaker algorithms) security mechanisms (for legacy SSH clients) if they want to use them in their network apart from the default cipher algorithms. The default SSH configurations do not use these weaker encryption ciphers algorithms due to security priority.

However, OcNOS allows the users to enable or disable the desired algorithms option using the following commands.

- [ssh server algorithm encryption \(page 300\)](#)
- [ssh server algorithm kex \(page 302\)](#)
- [ssh server algorithm mac \(page 304\)](#)

- [ssh server default algorithm \(page 307\)](#)
- [show ssh server algorithm \(page 306\)](#)



Note: If the user wishes to modify these defaults, they can reconfigure them with the desired algorithms. For instance, by default, the following algorithms are applied: "chacha20-poly1305@openssh.com, aes256-gcm@openssh.com, aes128-gcm@openssh.com, aes256-ctr, aes192-ctr, aes128-ctr." To remove any of these algorithms, the user must explicitly reconfigure the necessary algorithms, such as using the command: `sshserver algorithm encryption aes256-gcm@openssh.com,aes128-gcm@openssh.com`.

Feature Characteristics

Following are the currently supported encryptions in the SSH session.

- Provides flexibility to user to add or remove the desired SSH encryption algorithms for the following encryption methods.
 - KEX
 - MAC
 - Encryption
- By default, *chacha20-poly1305@openssh.com, aes256-gcm@openssh.com, aes128-gcm@openssh.com, aes256-ctr, aes192-ctr, aes128-ctr* ciphers are supported for a new SSH client to connect with the SSH server
- Allows user to configure multiple algorithms.
- Supports following Strongest Cipher algorithms
 - Strongest Ciphers
 - *chacha20-poly1305@openssh.com, aes256-gcm@openssh.com, aes128-gcm@openssh.com, aes256-ctr, aes192-ctr, aes128-ctr*
 - MAC algorithms
 - *hmac-sha2-512-etm@openssh.com,*
 - *hmac-sha2-256-etm@openssh.com,*
 - *hmac-sha2-512,*
 - *hmac-sha2-256,*
- KEX algorithms
 - *curve25519-sha256@libssh.org,*
 - *diffie-hellman-group18-sha512,*
 - *diffie-hellman-group16-sha512,*
 - *ecdh-sha2-nistp521,*
 - *ecdh-sha2-nistp384,*
 - *ecdh-sha2-nistp256*
 - *diffie-hellman-group14-sha256 (uses 2048-bit keys and considered strong)*
- Avoid configuring the weaker Cipher algorithms
 - Legacy weaker Cipher

- *aes128-ctr*
 - *aes192-ctr*
 - *aes256-ctr*
 - *aes128-cbc*
 - *aes192-cbc*
 - *aes256-cbc*(CBC mode is vulnerable to padding Oracle attacks)
 - *3des-cbc*
 - *blowfish-cbc*(Less efficient)
 - *arcfour*(Based on RC4 which has significant vulnerabilities)
 - *hmac-md5*(MD5 can be broken and should not be used)
 - *umac-64@openssh.com* (*Weaker than SHA-2 based MACs*)
 - *hmac-sha1*(Less secured and weak)
 - Extends support to all **VRF**¹ interfaces including user-defined.
- Allows users with Network Admin or Network Engineer or Network Operator privilege to configure.
 - Provides a show CLI command to view the configured SSH algorithms.
 - Configured algorithms are persistent even after reload.

Benefits

Enhanced security for remote terminal connections via SSH. It enables users to utilize the legacy SSH clients with the algorithms option through newly introduced commands.

Prerequisites

SSH process should be enabled.

Configuration

This section provides an example to encrypt an SSH session with cipher algorithm.

Use any one or all of the algorithms to encrypt a default, management or user defined interface SSH session.

- [ssh server algorithm mac \(page 304\)](#)
- [ssh server algorithm kex \(page 302\)](#)
- [ssh server algorithm encryption \(page 300\)](#)
- [ssh server default algorithm \(page 307\)](#)

Topology

In the below topology, the SSH client from the OcNOS device is initiating an SSH connection to a remote machine.

¹Virtual Routing and Forwarding

Figure 12. SSH Sample Topology



Note: Before configuration meet all [Prerequisites \(page 256\)](#).

Assign SSH security algorithm to a management Interface

1. Set the SSH server encryption algorithm for the management VRF.

```
(config)# ssh server algorithm mac hmac-sha2-256-etm hmac-sha1-96 hmac-md5-etm vrf management
```

2. Set the SSH server KEX algorithm for the management VRF.

```
(config)#ssh server algorithm kex ecdh-sha2-nistp256 ecdh-sha2-nistp384
ecdh-sha2-nistp521 vrf management
```

3. Set the SSH server MAC algorithm for the management VRF.

```
(config)# ssh server algorithm mac hmac-sha2-256-etm hmac-sha1-96 hmac-md5-etm vrf management
```

4. Commit the configuration and exit.

```
(config)#commit
(config)#exit
```

Assign SSH security algorithm to a default VRF Interface

1. Set the SSH server encryption algorithm for the default VRF.

```
(config)#ssh server algorithm encryption 3des-cbc aes128-cbc aes192-cbc aes256-cbc
```

2. Set the SSH server KEX algorithm for the default VRF.

```
(config)#ssh server algorithm kex diffie-hellman-group14-sha256 diffie-hellman-group16-sha512
diffie-hellman-group18-sha512
```

3. Set the SSH server MAC algorithm for the default VRF.

```
(config)# ssh server algorithm mac hmac-md5-etm umac-128
```

4. Commit the configuration and exit.

```
(config)#commit (config)#exit
```

Assign SSH security algorithm to a User Defined Interface

1. Create a user defined VRF interface with the name **vrf1**.

```
(config)#ip vrf vrf1
```



```
(config-vrf)# exit
```

2. Set the SSH server encryption algorithm for the User Defined **vrf1**.

```
(config)#ssh server algorithm encryption 3des-cbc aes128-cbc aes192-cbc aes256-cbc vrf vrf1
```

3. Set the SSH server KEX algorithm for the management **vrf1**.

```
ssh server algorithm kex diffie-hellman-group1-sha1 diffie-hellman-group14-sha1
```

4. Set the SSH server MAC algorithm for the management **vrf1**.

```
(config)#ssh server algorithm mac hmac-md5 hmac-md5-96 vrf vrf1
```

5. Commit the configuration and exit.

```
(config)#commit (config)#exit
```

Validation

Execute the following show command to view the SSH server informations.

```
#show running ssh server
feature ssh vrf management
ssh server algorithm mac hmac-sha2-256-etm hmac-sha1-96 hmac-md5-etm vrf management
ssh server algorithm encryption aes256-gcm rijndael-cbc aes128-ctr vrf management
ssh server algorithm kex ecdh-sha2-nistp256 ecdh-sha2-nistp384 ecdh-sha2-nistp521 vrf management

feature ssh
ssh server algorithm mac umac-128 hmac-md5-etm
ssh server algorithm encryption 3des-cbc aes128-cbc aes192-cbc aes256-cbc
ssh server algorithm kex diffie-hellman-group14-sha256 diffie-hellman-group16-sha512 diffie-hellman-
group18-sha512

feature ssh vrf vrf1
ssh server algorithm mac hmac-md5 hmac-md5-96 vrf vrf1
ssh server algorithm encryption 3des-cbc aes128-cbc aes192-cbc aes256-cbc vrf vrf1
ssh server algorithm kex diffie-hellman-group1-sha1 diffie-hellman-group14-sha1 diffie-hellman-
group14-sha256 vrf vrf1
```

Execute the following show command to view the configured SSH algorithms.

```
#show ssh server algorithm

management vrf ssh server algorithm:
Ciphers aes128-ctr,rijndael-cbc@lysator.liu.se,aes256-gcm@openssh.com,
KexAlgorithms ecdh-sha2-nistp256,ecdh-sha2-nistp384,ecdh-sha2-nistp521,
MACs hmac-sha1-96,hmac-sha2-256-etm@openssh.com,hmac-md5-etm@openssh.com,

default vrf ssh server algorithm:
Ciphers aes128-cbc,aes192-cbc,aes256-cbc,3des-cbc, KexAlgorithms diffie-hellman-group14-
sha256,diffie-hellman-group16-sha512,diffie-hellman-group18-sha512,
MACs umac-128@openssh.com,hmac-md5-etm@openssh.com,

vrf1 vrf ssh server algorithm:
Ciphers aes128-cbc,aes192-cbc,aes256-cbc,3des-cbc,
KexAlgorithms diffie-hellman-group1-sha1,diffie-hellman-group14-sha1,diffie-hellman-group14-sha256,
MACs hmac-md5,hmac-md5-96
```

SSH Key-Based Authentication

Enable OcNOS device SSH server to perform public key based SSH authentication, to enable machine to machine communication possible without requiring password. Public key based authentication increases the trust between

two Linux servers for easy file synchronization or transfer. Public-key authentication with SSH is more secure than password authentication, as it provides much stronger identity checking through keys.



Note: No support for Digital Signature Algorithm (DSA) public key authentication.

Topology

Figure 13. SSH Key-based authentication



Public Key Authentication Method

The server has the public key of the user stored; using this the server creates a random value, encrypts it with the public key and sends it to the user. If the user is who is supposed to be, he can decrypt the challenge using the private key and send it back to the server, server uses the public key again to decrypt received message to confirm the identity of the user. SSH is supported in-band (default **VRF**¹) and out-band (management VRF). Installed keys are stored in the `~/ .ssh/authorized_keys` file.

SSH key based authentication steps:

1. Login to remote machine Linux desktop (ssh client) and generate the key pair using the `ssh-keygen` command.
2. Create the username in OcNOS device (ssh server).
3. Install the public key of remote Linux ssh client in the OcNOS device.
4. Display the installed key in the OcNOS device using the `show running-config` command.
5. Log in from the remote Linux ssh client to the OcNOS device without providing a password.

Useful Commands on Remote Desktop Client

<code># ssh-keygen</code>	To generate key pair on remote Linux machine (ssh client)
<code># cd /bob/.ssh/</code>	To go to the location of saved key pair
<code># cat id_rsa.pub</code>	Command to display the generated public key in remote Linux client

¹Virtual Routing and Forwarding

Configuration commands in OcNOS

<code>(config)#configure terminal</code>	Enter configure mode.
<code>(config)#feature ssh vrf management</code>	Enable the SSH feature on vrf management. To enable in default vrf give the command "feature ssh"
<code>(config)#username fred</code>	To create username with default role as network-user. To create user with different role specify role using command "username <username> role <role_name>"
<code>(config)#username fred sshkey ssh-rsa AAAAB3NzaC1yc2EAAAADAQABAAQAC8XhFiG1ZP6yY6qIWUkew884NvqXqMPSOw3fQe5kqpXvX0SbcU15axI/VHVgU2Y0/ogAtRU1Ak5soRrf51Z2+rT0zNP37m+Tm5HIEFKZZut0FffGSuXtPKbE+GG1QYHEzC8RSnqQuHlxlrlve3lGbB1U UxuWhMzJfgc2vZ78V2znd2zk4ygiN1jxlsE8UI98WyIcwuq44tzuaUYAICIfRQJXriQml+QcJ9NER508rMS5D5NnTVhlnroqoozY8i/qMKfhCFMbyjsjIDMHU9GclNsNbIF/DQbvWESkFFEvf6fOrzXyvg26NpgaJnZ4pQVzGkOaVw16Cy3csoTncw0vyXV bob@localhost.localdomain</code>	Install the public key of remote Linux client in OcNOS device.
<code>(config)#commit</code>	Commit the candidate configuration to the running configuration
<code>(config)#exit</code>	Exit configure mode.

Validation

The new cipher encryption algorithm takes effect for a new incoming ssh client connection.

```
#show running-config

feature ssh vrf management
username fred role network-user
username fred sshkey
ssh-rsa
AAAAB3NzaC1yc2EAAAADAQABAAQAC8XhFiG1ZP6yY6qIWUkew884NvqXqMPSOw3fQe5kqpXvX0SbcU15axI/VHVgU2Y0/ogAtRU1Ak5soRrf51Z2+rT0zNP37m+Tm5HIEFKZZut0FffGSuXtPKbE+GG1QYHEzC8RSnqQuHlxlrlve3lGbB1U  
UxuWhMzJfgc2vZ78V2znd2zk4ygiN1jxlsE8UI98WyIcwuq44tzuaUYAICIfRQJXriQml+QcJ9NER508rMS5D5NnTVhlnroqoozY8i/qMKfhCFMbyjsjIDMHU9GclNsNbIF/DQbvWESkFFEvf6fOrzXyvg26NpgaJnZ4pQVzGkOaVw16Cy3csoTncw0vyXV bob@localhost.localdomain
<skipped other content>
#show running-config ssh server
feature ssh vrf management
```

SSH Key-based Client Session

<code>#ssh fred@10.10.26.186</code>	Specify user name and ip address to access the device. Supports IPv4 and IPv6. User should be able to access without password and through key based authentication
-------------------------------------	--

Restrictions

- Key generation or installation are not supported for "root" user account in OcNOS device.
- Third party SSH utilities cannot be used for key installation, rather OcNOS CLI is the only way to install public keys.

Sample Use Case

1. Login to remote machine linux desktop (ssh client) and generate the key pair using the `ssh-keygen` command.

```
[bob@localhost ~]# ssh-keygen
Generating public/private rsa key pair.
Enter file in which to save the key (/bob/.ssh/id_rsa):
/bob/.ssh/id_rsa already exists.
Overwrite (y/n)? y
Enter passphrase (empty for no passphrase):
Enter same passphrase again:
Your identification has been saved in /bob/.ssh/id_rsa.
Your public key has been saved in /bob/.ssh/id_rsa.pub.
The key fingerprint is:
b2:d0:cc:d2:dd:db:3d:05:c1:33:fc:4a:df:8e:85:af bob@localhost.localdomain
The key's randomart image is:
+--[ RSA 2048]-----+
|           o. |
|          =. |
|           .+ |
|         = . . . . |
|        o * S . . +o|
|         o o  o .o.+|
|          . . . o= |
|                   ..o|
|                   E. |
+-----+
[bob@localhost ~]# cd /bob/.ssh/
[bob@localhost .ssh]# cat id_rsa.pub
ssh-rsa
AAAAB3NzaC1yc2EAAAADAQABAAQCAQC8XhFiGlZP6yY6qIWUkew884NvqXqMPSow3fQe5kgrpXvX0SbcU15axI/VHVgU2Y0/
ogAtRUlAk5soRrf5lZ2+rT0zNP37m+Tm5HIEFKZzut0FffGSuXtPKbE+GG1QYHEzC8RSnqQuHlxlrlve3lGbB1UUxuWhMzJf
gc2vZ78V2znd2zk4ygiN1jx1sE8UI98WYIcwuq44tzUaUYAICIfRQJXriQml+QcJ9NER508rMS5D5NnTVh1nroqoozY8i/
qMKfhCFMbyjsjDMHU9GclNsNbIF/DQbvWEskFFEvf6fOrzXyvq26NpgaJnZ4pQVzgzOaVw16Cy3csoTncw0vyXV
bob@localhost.localdomain
[bob@localhost .ssh]#
```

2. Create username in OcNOS switch device (ssh server)

```
(config)#username fred
```



Note: By default, the user role is `network-user`.

3. Install the public key of remote Linux ssh client in OcNOS device.

```
(config)#username fred sshkey
ssh-rsa
AAAAB3NzaC1yc2EAAAADAQABAAQCAQC8XhFiGlZP6yY6qIWUkew884NvqXqMPSow3fQe5kgrpXvX0SbcU15axI/VHVgU2Y0/
ogAtRUlAk5soRrf5lZ2+rT0zNP37m+Tm5HIEFKZzut0FffGSuXtPKbE+GG1QYHEzC8RSnqQuHlxlrlve3lGbB1UUxuWhMzJf
gc2vZ78V2znd2zk4ygiN1jx1sE8UI98WYIcwuq44tzUaUYAICIfRQJXriQml+QcJ9NER508rMS5D5NnTVh1nroqoozY8i/
qMKfhCFMbyjsjDMHU9GclNsNbIF/DQbvWEskFFEvf6fOrzXyvq26NpgaJnZ4pQVzgzOaVw16Cy3csoTncw0vyXV
bob@localhost.localdomain
```

4. Display the installed key in OcNOS device using the **show running-config** command.

```
#show running-configg
<skipped other content>
username fred role network-user
username fred sshkey
ssh-rsa
AAAAB3NzaC1yc2EAAAADAQABAAQBAQC8XhFiGlZP6yY6qIWUkew884NvqXqMPSow3fQe5kqpXvX0SbcU15axI/VHVgU2Y0/
ogAtRUlAk5soRrf5lZ2+rT0zNP37m+Tm5HIEFKZzut0FffGSuXtPKbE+GGlQYHEzC8RSnqQuHlxrlve3lGbB1UUxuWhMzJf
gc2vZ78V2znd2zk4ygiNljx1sE8UI98WyIcwuq44tzuIaUYAICIfRQJXriQml+QcJ9NER5O8rMS5D5NnTVhlnroqoozY8i/
qMKfhCFMbyjsjiDMHU9GclNsNbIF/DQbvWEskFFEvf6fOrzXyvq26NpgaJnZ4pQVzgzOaVw16Cy3csoTncw0vyXV
bob@localhost.localdomain
<skipped other content>
```

5. Login from remote Linux ssh client to OcNOS device without providing password.

```
[bob@localhost .ssh]# ssh fred@10.10.26.186
```

Max Session and Session Limit Configuration

Overview

User can configure session-limit for Telnet and SSH sessions separately but this max-session parameter value takes the precedence to restrict the maximum number of sessions. If user configured this max-session to be 4, then the device would allow only maximum of 4 SSH and Telnet sessions collectively irrespective of the individual SSH and Telnet max-session configuration. Active sessions won't be disturbed even if the configured max-session limit is lesser than the current active sessions. Default value for max-session value is 40 in line mode. There is no default value for the telnet-server-limit and ssh-server-limit.

After configuring max-session parameter if user tries to configure SSH/Telnet sessions then the total value of Telnet and SSH session limit should be lesser than the max-session value otherwise error will be thrown.

If already Telnet and SSH session-limits configured, now if user is configuring max-session then there won't be any error but maximum number of sessions will be limited to max-session value.

Topology

The procedures in this section use the topology as mentioned below. Setup consists of one node acting as Telnet server.

Figure 14. Telnet topology

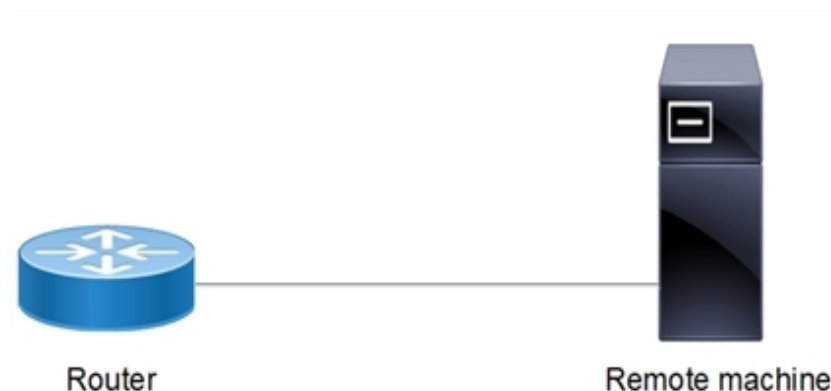

Configuration of Telnet Session Limit Lesser than Max-Session

<code>#configure terminal</code>	Enter configure mode
<code>(config)#no feature telnet vrf management</code>	Disable Feature Telnet in VRF ¹ Management
<code>(config)#telnet server session-limit 12 vrf management</code>	Configure the Session limit as 12 which is less than Max-Session parameter in line VTY

¹Virtual Routing and Forwarding

(config)#commit	Perform commit to submit the changes done
(config)#feature telnet vrf management	Enable telnet feature in VRF management
(config)#commit	Perform commit to submit the changes done
(config)#exit	Exit configure mode

Validation

Check that the maximum telnet session possible are 12 which is lesser than Max-Session limit parameter value in line VTY.

```
#show running-config telnet server
telnet server session-limit 12 vrf management
feature telnet vrf management
no feature telnet
```

Configuration of SSH Server Session Limit Lesser than Max-Session

Configure SSH Server Session limit to be lesser than Max-Session.

Topology

Setup consists of one node acting as SSH server.

Figure 15. SSH Server topology

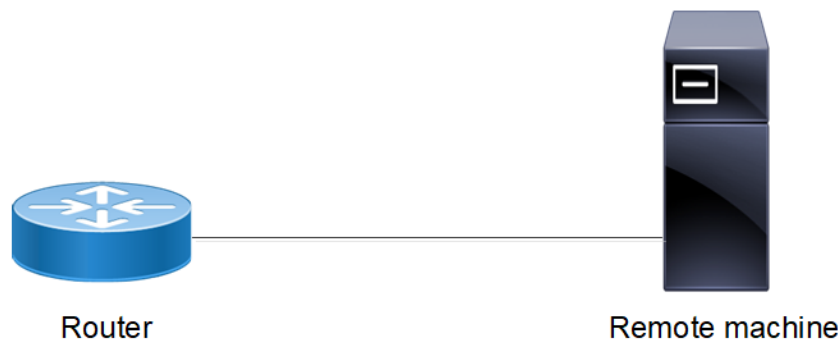

Configuration of SSH Server Session Limit Lesser than Max-Session

#configure terminal	Enter configure mode
(config)#no feature ssh vrf management	Disable feature SSH
(config)#ssh server session-limit 12 vrf management	Configure SSH server session-limit to be lesser than Max-Session limit
(config)#commit	Perform Commit to submit changes done
(config)#feature ssh vrf management	Enable feature SSH
(config)#commit	Perform commit to submit changes
(config)#exit	Exit configure mode

Validation

Check that the maximum SSH session possible are 12 which is lesser than Max-Session limit parameter value in line VTY.

```
#show running-config ssh server
feature ssh vrf management
ssh server session-limit 12 vrf management
no feature ssh
```

Configuration of Telnet Session Limit Greater than Max-Session

In the below section, configure Telnet Session limit to be greater than Max-Session limit.

Topology

Setup consists of one node acting as Telnet server.

Figure 16. Telnet Session Topology



Configuration of Telnet server Session-Limit to be greater than line-VTY max-session

#configure terminal	Enter configure mode
(config)#no feature telnet vrf management	Disable feature telnet
(config)#telnet server session-limit 12 vrf management	Configure Session-limit as 12 for telnet server
(config)#commit	Perform commit to submit changes
(config)#feature telnet vrf management	Enable Telnet server
(config)#commit	Perform commit to submit changes
(config)#line vty	Enter line VTY mode
(config-line)#max-session 10	Configure max-session as 10
(config-line)#commit	Perform commit to submit changes
(config)#exit	Exit configure mode

Validation

Check that the total telnet sessions possible is 10 even though telnet server session limit is configured as 12.

```
#show running-config telnet server
telnet server session-limit 12 vrf management
feature telnet vrf management
no feature telnet

#show running-config | grep max-session
max-session 10
```

Configuration of SSH Session Limit Greater than Max-Session

In the below section, configure SSH Session limit to be greater than Max-Session limit.

Topology

Setup consists of one node acting as SSH server.



Configuration of SSH server Session-Limit to be greater than line-vty max-session

#configure terminal	Enter configure mode
(config)#no feature ssh vrf management	Disable feature SSH
(config)#ssh server session-limit 12 vrf management	Configure Session-limit as 12 for SSH server
(config)#commit	Perform commit to submit changes
(config)#feature ssh vrf management	Enable SSH server
(config)#commit	Perform commit to submit changes
(config)#line vty	Enter line VTY mode
(config-line)#max-session 10	Configure max-session as 10
(config-line)#commit	Perform commit to submit changes
(config)#exit	Exit configure mode

Validation

Check that the total SSH sessions possible is 10 even though SSH server session limit is configured as 12.

```
#show running-config ssh server
feature ssh vrf management
ssh server session-limit 12 vrf management
no feature ssh

#show running-config | grep max-session
max-session 10
```

REMOTE DEVICE CONNECT COMMAND REFERENCE

Telnet	269
debug telnet server	270
feature telnet	271
show debug telnet-server	272
show running-config telnet server	273
show telnet-server	274
telnet	275
telnet6	276
telnet server port	277
telnet server session-limit	278
Secure Shell Commands	279
clear ssh host-key	280
clear ssh hosts	281
clear ssh keypair	282
debug ssh server	283
feature ssh	284
show debug ssh-server	285
show running-config ssh server	286
show ssh host-key	287
show ssh server	289
show username	290
ssh	291
ssh6	293
ssh algorithm encryption	295
ssh keygen host	297
ssh login-attempts	299
ssh server algorithm encryption	300
ssh server algorithm kex	302
ssh server algorithm mac	304
show ssh server algorithm	306
ssh server default algorithm	307
ssh server port	308
ssh server session-limit	309
username sshkey	310
username keypair	311

Telnet

This chapter describes telnet commands.

Telnet is a client/server protocol that establishes a session between a user terminal and a remote host:

- The telnet client software takes input from the user and sends it to the server's operating system
- The telnet server takes output from the host and sends it to the client to display to the user

While telnet is most often used to implement remote login capability, the protocol is general enough to allow it to be used for a variety of functions.



Notes: In OcNOS, the default Linux terminal type is "export TERM=xterm"

The commands below are supported only on the "management" VRF¹.

This chapter contains these commands:

debug telnet server	270
feature telnet	271
show debug telnet-server	272
show running-config telnet server	273
show telnet-server	274
telnet	275
telnet6	276
telnet server port	277
telnet server session-limit	278

¹Virtual Routing and Forwarding

debug telnet server

Use this command to display telnet debugging information.

Use the `no` form of this command to stop displaying telnet debugging information.

Command Syntax

```
debug telnet server
no debug telnet server
```

Parameters

None

Default

None

Command Mode

Execution mode and Configure mode

Applicability

This command was introduced before OcNOS version 1.3.

Examples

```
#show debug telnet-server

telnet server debugging is on
#
```

feature telnet

Use this command to enable the telnet server.

Use the `no` form of this command to disable the telnet server.



Note: Executing `no` form command closes the active telnet session.

Command Syntax

```
feature telnet (vrf management|)
no feature telnet (vrf management|)
```

Parameters

management

Virtual Routing and Forwarding name

Default

None

Command Mode

Configure mode

Applicability

This command was introduced before OcNOS version 1.3.

Examples

```
#configure terminal
(config)#feature telnet vrf management
```

show debug telnet-server

Use this command to display whether telnet debugging is enabled.

Command Syntax

```
show debug telnet-server
```

Parameters

None

Command Mode

Execution mode

Applicability

This command was introduced before OcNOS version 1.3.

Examples

```
#show debug telnet-server  
telnet server debugging is on
```

show running-config telnet server

Use this command to display telnet settings in the running configuration.

Command Syntax

```
show running-config telnet server
```

Parameters

None

Command Mode

Execution mode

Applicability

This command was introduced before OcNOS version 1.3.

Examples

```
#show running-config telnet server  
  
feature telnet vrf management  
no feature telnet
```

show telnet-server

Use this command to display the telnet server status.

Command Syntax

```
show telnet server
```

Parameters

None

Command Mode

Execution mode

Applicability

This command was introduced before OcNOS version 1.3.

Examples

```
#show telnet server

VRF MANAGEMENT
telnet server enabled port: 23

VRF DEFAULT:
telnet server disabled port: 23
```

telnet

Use this command to open a telnet session to an ipv4 address or host name resolved to ipv4 address.

Command Syntax

```
telnet (A.B.C.D | HOSTNAME) (vrf (NAME|management))  
telnet (A.B.C.D | HOSTNAME) (<1-65535>) (vrf (NAME|management))
```

Parameters

A.B.C.D

Destination IPv4 Address to open a telnet session.

HOSTNAME

Destination Hostname to resolve into IPv4 address to open a telnet session.

1-65535

Destination Port to open a telnet session. Default is 23.

vrf

Specify the VPN routing/forwarding instance.

NAME

Specify the name if the VPN routing/forwarding instance.

management

Management VPN routing/forwarding instance name.

Default

By default, telnet is 23

Command Mode

Privileged execution mode

Applicability

This command was introduced before OcNOS version 1.3.

Examples

```
#telnet 10.12.16.17 2543 vrf management  
Trying 10.12.16.17...
```

telnet6

Use this command to open a telnet session to an ipv6 address or host name resolved to ipv6 address.

Command Syntax

```
telnet6 (X:X::X:X| HOSTNAME) (vrf (NAME|management))
telnet6 (X:X::X:X | HOSTNAME) (<1-65535>) (vrf (NAME|management))
```

Parameters

X:X::X:X

Destination IPv6 Address to open a telnet session.

HOSTNAME

Destination Host name to resolve into IPv6 address to open a telnet session.

1-65535

Destination Port to open a telnet session. Default is 23.

vrf

Specify the VPN routing/forwarding instance.

NAME

Specify the name if the VPN routing/forwarding instance.

management

Management VPN routing/forwarding instance name.

Default

By default, telnet is 23.

Command Mode

Privileged execution mode

Applicability

This command was introduced before OcNOS version 1.3.

Examples

```
#telnet6 2:2::2:2 2543 vrf management
Trying 2:2::2:2...
```

telnet server port

Use this command to set the port number on which the telnet server listens for connections. The default port on which the telnet server listens is 23.

You can only give this command when the telnet server is disabled. See the [feature telnet \(page 271\)](#) command.

Use the `no` form of this command to set the default port number (23).

Command Syntax

```
telnet server (port <1024-65535>) (vrf management|)
no telnet server port (vrf management|)
```

Parameters

<1024-65535>

Port number

management

Virtual Routing and Forwarding name

Default

By default, telnet server port number is 23

Command Mode

Configure mode

Applicability

This command was introduced before OcNOS version 1.3.

Examples

```
#configure terminal
(config)#telnet server port 1157 vrf management
```

telnet server session-limit

Use this command to limit number of Telnet sessions. Only 40 sessions allowed including Telnet and SSH. User can only give this command when the telnet server is disabled. See the [feature telnet \(page 271\)](#) command.

Use `no` form of this command to set to default value.

Command Syntax

```
telnet server session-limit <1-40> (vrf management|)
no telnet server session-limit (vrf management|)
```

Parameters

<1-40>

Number of sessions

management

Virtual Routing and Forwarding name

Default

By default, 40 sessions are allowed.

Command Mode

Configure mode

Applicability

This command was introduced in OcNOS version 4.2

Examples

```
#configure terminal
(config)#telnet server session-limit 4 vrf management
```

Secure Shell Commands

This chapter describes Secure Shell (SSH) commands.

SSH is a cryptographic protocol for secure data communication, remote login, remote command execution, and other secure network services between two networked computers.

- In OcNOS, the default Linux terminal type is "export TERM=xterm"
- The commands below are supported only on the "management" VRF¹.

This chapter contains these commands:

clear ssh host-key	280
clear ssh hosts	281
clear ssh keypair	282
debug ssh server	283
feature ssh	284
show debug ssh-server	285
show running-config ssh server	286
show ssh host-key	287
show ssh server	289
show username	290
ssh	291
ssh6	293
ssh algorithm encryption	295
ssh keygen host	297
ssh login-attempts	299
ssh server algorithm encryption	300
ssh server algorithm kex	302
ssh server algorithm mac	304
show ssh server algorithm	306
ssh server default algorithm	307
ssh server port	308
ssh server session-limit	309
username sshkey	310
username keypair	311

¹Virtual Routing and Forwarding

clear ssh host-key

Use this command to clear the host keys.

Command syntax

```
clear ssh host-key ((dsa|rsa|ecdsa|ed25519)|) (vrf (NAME|management)|)
```

Parameters

dsa

dsa keys

rsa

rsa keys

ecdsa

ecdsa keys

ed25519

ed25519 keys

vrf management

Defines the management **VRF**¹ instance.

vrf NAME

Specify the user-defined VRF instance name.

Default

None

Command Mode

Privileged execution mode

Applicability

This command was introduced in OcNOS version 5.0. Added parameter NAME in OcNOS version 6.5.3.

Examples

```
OcNOS#clear ssh host-key
```

¹Virtual Routing and Forwarding

clear ssh hosts

Use this command to clear the `known_hosts` file.

This command clears all trusted relationships established with SSH servers during previous connections. When a client downloads a file from an external server the first time, the client stores the server keys in the `known_hosts` file. After that, other connections to the same server will use the server keys stored in the `known_hosts` file. In other words, a trusted relationship is created when a client accepts the server keys the first time.

An example of when you need to clear a trusted relationship is when SSH server keys are changed.

Command Syntax

```
clear ssh hosts
```

Parameters

None

Command Mode

Execution mode

Applicability

This command was introduced before OcNOS version 1.3.

Examples

```
#clear ssh hosts
```

clear ssh keypair

Use this command to clear RSA/DSA keypair generated for an user. This command can be executed only by networkadmin.

Command Syntax

```
clear ssh keypair user USERNAME
```

Parameters

None

Command Mode

Execution mode

Applicability

This command was introduced before OcNOS version 4.1.

Examples

```
#clear ssh keypair user test
```

debug ssh server

Use this command to display SSH server debugging information.

Use the `no` form of this command to stop displaying SSH server debugging information.

Command Syntax

```
debug ssh server
no debug ssh server
```

Parameters

None

Default

By default, disabled.

Command Mode

Execution mode and Configure mode

Applicability

This command was introduced before OcNOS version 1.3.

Examples

```
#debug ssh server
```

feature ssh

Use this command to enable the SSH server.

Use the `no` form of this command to disable the SSH server.

Command Syntax

```
feature ssh (vrf (NAME|management) |)
no feature ssh (vrf (NAME|management) |)
```

Parameters

vrf management

Defines the management **VRF**¹ instance.

vrf NAME

Specify the user-defined VRF instance name.

Default

By default, feature ssh is enabled.

Command Mode

Configure mode

Applicability

This command was introduced before OcNOS version 1.3. Added parameter vrf NAME in OcNOS version 6.5.3

Examples

```
#configure terminal
(config)#feature ssh
```

¹Virtual Routing and Forwarding

show debug ssh-server

Use this command to display whether SSH debugging is enabled.

Command Syntax

```
show debug ssh-server
```

Parameters

None

Command Mode

Execution mode

Applicability

This command was introduced before OcNOS version 1.3.

Examples

```
#show debug ssh-server  
ssh server debugging is on
```

show running-config ssh server

Use this command to display SSH settings in the running configuration.

Command Syntax

```
show running-config ssh server
```

Parameters

None

Command Mode

Execution mode

Applicability

This command was introduced before OcNOS version 1.3.

Examples

```
#show running-config ssh server
feature ssh vrf management
ssh server port 1024 vrf management
ssh login-attempts 2 vrf management
ssh server algorithm encryption 3des-cbc
```

show ssh host-key

Use this command to display the SSH server key.

By default, ssh feature is enabled in "management" vrf. Until and unless the same feature is explicitly enabled in "default" vrf, respective show command output will be empty.

Command syntax

```
show ssh host-key ((dsa|rsa|ecdsa|ed25519)|) no feature ssh (vrf (NAME|management)|)
```

Parameters

dsa

dsa keys

rsa

rsa keys

ecdsa

ecdsa keys

ed25519

ed25519 keys

management

Management **VRF**¹

NAME

Custom VRF

Default

If no keys are specified, all host keys will be displayed

Command Mode

Execution mode

Applicability

This command was introduced in OcNOS version 5.0. Added parameter NAME in OcNOS version 6.5.3.

Examples

```
#sh ssh host-key
*****
dsa public key :

ssh-dss AAAAB3NzaC1kc3MAAACBANgq+TZPkmKOn7ot7PBO9TOCV/+GPyHCz9Wq39+6veigQ2CWmLNo
uqZb1B05LfeU2MurZ4rtO6mcX8lnAygqDLNZaRsirYdWTsJ40HAOZYr9765w+M8TAcKmBYbuWSIkqnYQ
J1h5bj6UrJ7dW4LgaSxmVmrkXoYrr5gnxfEVgw8HAAAAFQC//BVHnTWh8Iizbk0mvOyNzqtFMwAAAIbQ
Ca9X0qbL66Js0ul+7LMmLvWkC4Fy1Y/3igZORZ+NsnP4CJIJ1JCLwj7nj/NeUfUuyG1/dnDVdki4FngL
LjbVa5XrK5VbsEj4sZBfebKLVZKd8h880FqNhfc3iZjCGqdYrWWlRYdNqNvq7zVa6YC7Vvo0sEC5/rDm
```

¹Virtual Routing and Forwarding

```

aNygbx0iCAAAAEIAoZHk+5cqaYptqYBPGPMRynpWyWJPJQjoiy+p1BRnk7E/kwInQaqmtFQuM/YaTOoN
nz5skwQldJmdJGq+h7bfmab0atzaavjkcTjz0rtSBO3JID2G6KqG55yhr03bc8BY+A6g9Qm8TuWZU68D
NIzGj28GZSbkIpQgqSD9VUAxEHs=

dsa fingerprint :

1024 SHA256:Qzd8n4RjsxeW9+AnUP+zc59oPRTl2FBwdwDfVBq0DdQ
*****
*****
rsa public key :

ssh-rsa AAAAB3NzaC1yc2EAAAADAQABAAQAC706mz0GQvdEaqK/2zUUtCOh/kEUkZpQ7d8gie4jf1
yV4nV2g1u7oIbdnoBBI0a5bIwbUGDHPUvfTpoJntpryY7G/QIWuBJVDiu6QteoB4u5byNVbSqA3fljbf
MISYfLxK3i3S07htadDfUIpYTyx/D5PCf8DDxmdf7UkhOM4Quj8GgGW3PacE2YyJASBq5x7MaWEUiStu
NgtemWqR/DTw+OO8l3gZzHhWbcmHLzo3jdkH/8ffLGEWqEb78wR4lxckVlja4suFB0GEa7vFLucY03Tp
GzZARf7iY5A0bB0fi7Zi1yQ3RN7+di28lSNWsfCzZm8vWS7GyLUFnlxttlqJ

rsa fingerprint :

2048 SHA256:YVX+zlrDk8bqzF+HPKpFW0BttbLoiQ5IBDVI/VMYhbs
*****
*****
ecdsa public key :

ecdsa-sha2-nistp256 AAAAE2VjZHNhLXNoYTItbmlzdHAyNTYAAAAIbmlzdHAyNTYAAABBBBCN/XoG
uZGwNfKCE+cuQOULrSHomRSmkDp0u6MsoNIVLhtRe9+r8Ak7G8taE55D7NgugnEDzdLKBmeCZWcww64=

ecdsa fingerprint :

256 SHA256:T7K0gXyrU/38EvO6z/apgYDANf+q9YhqCiYoocD5Ajpg
*****
*****
ed25519 public key :

ssh-ed25519 AAAAC3NzaC1lZDI1NTE5AAAAII/jNFIYKbUk/ePbp4wu/AjhP5gERqn6F+4tH39idbh7

ed25519 fingerprint :

256 SHA256:1MU6iy03eEQBj099GERLjkMCPDoUwkdCwGh8bgYZbeo
*****
#

```

show ssh server

Use this command to display the SSH server status.

Command Syntax

```
show ssh server
```

Parameters

None

Command Mode

Execution mode

Applicability

This command was introduced before OcNOS version 1.3.

Examples

```
#show ssh server
VRF MANAGEMENT:
ssh server enabled port: 22
authentication-retries 3
VRF DEFAULT:
ssh server enabled port: 22
authentication-retries 3
#
```

show username

Use this command to display the RSA or DSA key pair for a user.

Command Syntax

```
show username USERNAME keypair
```

Parameters

USERNAME

User identifier

Command Mode

Execution mode

Applicability

This command was introduced before OcNOS version 1.3.

Examples

```
#show username OcNOS keypair
*****RSA KEY*****
ssh-rsa AAAAB3NzaC1yc2EAAAADAQABAAQDCnWo/3Y7LlVkw/Z43dbVIm+I3o25JlgUTmwa91l
T35+2gNvDbIPfYAqUKYgrmXKDC9vg7f4SAsmXS+4ZwrrQSTtShk8PNLA+4lEcufFN13jpfXTuhphN9N9
i+uFHGYIIviWZksiRqpMZmDlALyZAI0zyCfG44hlRm3/pYfhBNhHruvxyVhbP4wHsmrWfcFb+HZCWQGM
CJupxu8bouGd2UW5/B1VylyuYNIhdo2NHjUI+ameETV+Wroki8+OLVA6eXp5/KY3Bj9x2+AxOCiKcpU0
axwFS0CbP3+29wrp4JJh14ssSqM+19+VbUtpuXAM0cR7VQ7mJ0JDZ9tBvK418/
bitcount: 2048 fingerprint: 2b:ac:17:a4:ef:1d:79:4e:2d:17:af:72:4c:c7:e4:2f
*****
*****DSA KEY*****
ssh-dss AAAAB3NzaC1kc3MAAACBAP0npAm+Pw8t7Op0+KQ0Vx3ayXavHHVPPAKOo8RTmquE8zUSjn
/XiZ+vP2343RpXu9/jLwAcUMfNBZyE8NbmGKxMMk2PqMz10VtfvD0n5LSNurXL4lypZLG2hR2PNva4w
6b4Adpd+E1fEoUncIgOun2i4SO8N5TCMYVusKjYzDAAAFQCWeAzeahZeoIzBlnSo87madxfL3QAAAI
EA4b861/nHoWobRoYBrkeOGtjyWLRkk1P2T+rGH+j0rqqJiD0sh2PVfppy11iNvqLtYSmXyMCxzEEeFd
HH1cVXgrgQjtU0eCPhF+2We2ummm1Cwg4v71Z358FRjsi9VgJ/vQUpOqlhRDhwjJHtEHSA+NkX/ccW9J
ww8Y0oNhCI7DcAAACANuYiP6tKGSU9LeClF1F65Tq1blVHfLp3TSeZYPldqonDoZ1qo3NNvOOH5KN8Lj
MRtTCN1GaXow1Qccs941XFy3efuWXx00HZ64FhmjCyOYyv2Wsvn4UGCAG3ikiu6M1xjOL16b53H4mB3
w706bkcyjH1Gnytwrgr0D/nlsZ/9fs=
bitcount: 1024 fingerprint: c1:0a:e5:e1:a1:78:ae:c2:4a:07:4a:50:07:4b:d5:84
*****
```

ssh

Use this command to open an ssh session to a IPv4 address or host name resolved to an IPv4 address.

Command Syntax

```
ssh WORD (vrf (NAME | management))
ssh WORD <1-65535> (vrf (NAME | management))
ssh (cipher (aes128-ctr | aes192-ctr | aes256-ctr | aes128-cbc | aes192-cbc | aes256-cbc | 3des-cbc))
WORD (vrf (NAME | management))
ssh (cipher (aes128-ctr | aes192-ctr | aes256-ctr | aes128-cbc | aes192-cbc | aes256-cbc | 3des-cbc))
WORD <1-65535> (vrf (NAME | management))
```

Parameters

WORD

User and Destination Host name to resolve into IPv4 Address or IPv4 address to open a SSH session as user@ipv4-address/Hostname

1-65535

Destination Port to open a SSH session. Default is 22

cipher

Specify algorithm to encrypt SSH session

aes128-ctr

Advanced Encryption Standard 128 bit Counter Mode

aes192-ctr

Advanced Encryption Standard 192 bit Counter Mode

aes256-ctr

Advanced Encryption Standard 256 bit Counter Mode

aes128-cbc

Advanced Encryption 128 bit Standard Cipher Block Chaining

aes192-cbc

Advanced Encryption Standard 192 bit Cipher Block Chaining

aes256-cbc

Advanced Encryption Standard 256 bit Cipher Block Chaining

3des-cbc

Triple Data Encryption Standard Cipher Block Chaining

vrf management

Defines the management **VRF**¹ instance.

vrf NAME

Specify the user-defined VRF instance name.

Default

The default destination port is 22.

¹Virtual Routing and Forwarding

Command Mode

Privileged execution mode

Applicability

This command was introduced before OcNOS version 1.3.

Examples

```
#ssh cipher aes128-ctr 10.12.16.17 22 vrf management
The authenticity of host '10.12.16.17 (10.12.16.17)' can't be established.
RSA key fingerprint is 93:82:98:ce:b7:20:1a:85:a5:9a:2e:93:13:84:ea:9e.
Are you sure you want to continue connecting (yes/no)?
```

ssh6

Use this command to open an ssh session to an IPv6 address or host name resolved to an IPv6 address.

Command Syntax

```
ssh6 (X:X::X:X | HOSTNAME) (vrf (NAME | management))
ssh6 (X:X::X:X | HOSTNAME) <1-65535> (vrf (NAME | management))
ssh6 (cipher (aes128-ctr | aes192-ctr | aes256-ctr | aes128-cbc | aes192-cbc | aes256-cbc | 3des-cbc))
(X:X::X:X | HOSTNAME) (vrf (NAME | management))
ssh6 (cipher (aes128-ctr | aes192-ctr | aes256-ctr | aes128-cbc | aes192-cbc | aes256-cbc | 3des-cbc))
(X:X::X:X | HOSTNAME) <1-65535> (vrf (NAME | management))
```

Parameters

X:XX::X:X

User and Destination IPv6 Address to open a ssh session as user@ipv6-address

HOSTNAME

User and Destination Host name to resolve into IPv6 Address to open an ssh session as user@ipv4-address/Hostname

1-65535

Destination Port to open a ssh session. Default is 22.

cipher

Specify algorithm to encrypt SSH session

aes128-ctr

Advanced Encryption Standard 128 bit Counter Mode

aes192-ctr

Advanced Encryption Standard 192 bit Counter Mode

aes256-ctr

Advanced Encryption Standard 256 bit Counter Mode

aes128-cbc

Advanced Encryption 128 bit Standard Cipher Block Chaining

aes192-cbc

Advanced Encryption Standard 192 bit Cipher Block Chaining

aes256-cbc

Advanced Encryption Standard 256 bit Cipher Block Chaining

3des-cbc

Triple Data Encryption Standard Cipher Block Chaining

vrf management

Defines the management **VRF**¹ instance.

vrf NAME

Specify the user-defined VRF instance name.

Default

The default destination port is 22.

¹Virtual Routing and Forwarding

Command Mode

Privileged execution mode

Applicability

This command was introduced before OcNOS version 1.3.

Examples

```
#ssh6 cipher aes128-ctr 2:2::2:2 22 vrf management
The authenticity of host '2:2::2:2 (2:2::2:2)' can't be established.
RSA key fingerprint is 93:82:98:ce:b7:20:1a:85:a5:9a:2e:93:13:84:ea:9e.
Are you sure you want to continue connecting (yes/no)?
```

ssh algorithm encryption

Use this command to set an encryption algorithm for SSH sessions.

An SSH server authorizes connection of only those algorithms that are configured from the list below. If a client tries establishing a connection to the server with the algorithm encryption that are not part of the list, the connection will not established.

SSH supports these encryption algorithms:

Advanced Encryption Standard Counter:

- aes128-ctr
- aes192-ctr
- aes256-ctr
- aes128-cbc

Advanced Encryption Standard Cipher Block Chaining:

- aes192-cbc
- aes256-cbc

Triple Data Encryption Standard Cipher Block Chaining:

3des-cbc

Use the no form of this command to not encrypt SSH sessions.

Command Syntax

```
ssh server algorithm encryption {aes128-ctr | aes192-ctr | aes256-ctr | aes128-cbc | aes192-cbc |  
aes256-cbc | 3des-cbc} (vrf (NAME|management)|)  
no ssh server algorithm encryption {aes128-ctr | aes192-ctr | aes256-ctr | aes128-cbc | aes192-cbc |  
aes256-cbc | 3des-cbc} (vrf (NAME|management)|)
```

Parameters

aes18-ctr

AES 128 bit Counter Mode

aes192-ctr

AES 192 bit Counter Mode

aes256-ctr

AES 256 bit Counter Mode

aes128-cbc

AES 128 bit Cipher block chaining

aes192-cbc

AES 192 bit Cipher block chaining

aes256-cbc

AES 256 bit Cipher block chaining

3des-cbc

Triple DES Cipher block chaining

vrf

Virtual Routing and Forwarding

NAME

Virtual Routing and Forwarding name

Default

No default value is specified.

By default, all the ciphers are supported for a new SSH client to connect to the SSH server.

Command Mode

Configure mode

Applicability

This command was introduced before OcNOS version 1.3. Added parameter **VRF**¹ NAME in OcNOS version 6.5.3

Examples

```
#configure terminal
(config)#ssh server algorithm encryption aes128-ctr
```

¹Virtual Routing and Forwarding

ssh keygen host

Use these commands to create SSH server host, and public keys. These host keys are added in the SSH clients known_hosts file after user's acceptance.

Once entry is added in known_hosts, for the subsequent attempt login to the server will be validated against the host key and if there is key mismatch user will be prompted about the change in server identity.

Command syntax

```
ssh keygen host dsa (vrf (NAME|management)) (force|)
ssh keygen host rsa (length <1024-4096>|) (vrf (NAME|management)) (force|)
ssh keygen host ecdsa (length (256|384|521)|) (vrf (NAME|management)) (force|)
ssh keygen host ed25519 (vrf (NAME|management)) (force|)
```

Parameters

dsa

dsa keys

rsa

rsa keys

ecdsa

ecdsa keys

ed25519

ed25519 keys

force

Replace the old host-key with newly generated host-key

<1024-4096>

Number of bits to use when creating the SSH server key; this parameter is only valid for RSA keys (DSA keys have a default length of 1024).

vrf management

Defines the management **VRF**¹ instance.

vrf NAME

Specify the user-defined VRF instance name.

Default

DSA key has length of 1024 bits

RSA key has default length of 2048 bits

ECDSA key has default length of 521 bits

ED25519 key has length of 256 bits

Command Mode

Privileged execution mode

¹Virtual Routing and Forwarding

Applicability

This command was introduced in OcNOS version 5.0. Added parameter NAME in OcNOS version 6.5.3.

Examples

```
OcNOS#ssh keygen host rsa vrf management
OcNOS#
OcNOS#ssh keygen host ecdsa vrf management
OcNOS#
OcNOS#ssh keygen host ecdsa
%% ssh host key exists, use force option to overwrite
OcNOS#
OcNOS#ssh keygen host ecdsa force
OcNOS#
```

ssh login-attempts

Use this command to set the number of times SSH client would try to authenticate to establish the SSH session. Use the `no` form of this command to set the number of authentication attempts to its default (3).



Note: By default, SSH clients may send the keys to authenticate, such a implicit authentication failures would also decrease authentication attempt count. Hence the configured value is not directly proportional to the user's password based authentication attempt.

Enable the feature `ssh` command to configure this command on default **VRF**¹ port.

You can only give this command when the SSH server is enabled for default VRF. See the feature `ssh` command.

Command Syntax

```
ssh login-attempts <1-3> (vrf (NAME|management) |)
no ssh login-attempts (vrf (NAME|management) |)
```

Parameters

<1-3>

Retries attempts, default is 3 attempts

vrf management

Defines the management VRF instance.

vrf NAME

Specify the user-defined VRF instance name.

Default

By default, the device attempts to negotiate a connection with the connecting host three times.

Command Mode

Configure mode

Applicability

This command was introduced before OcNOS version 1.3.

Examples

```
#configure terminal
(config)#ssh login-attempts 3
```

¹Virtual Routing and Forwarding

ssh server algorithm encryption

Use this command to configure Cipher algorithms.

Use `no` parameter to remove the Cipher algorithms.

Command Syntax

```
ssh server algorithm encryption CIPHER_NAME vrf (|management|NAME)
no ssh server algorithm encryption
```

Parameters

CIPHER_NAME

Specifies the SSH encryption type as Cipher exchange.

3des-cbc
aes128-cbc
aes192-cbc
aes256-cbc
rijndael-cbc
aes128-ctr
aes192-ctr
aes256-ctr
aes128-gcm
aes256-gcm
chacha20-poly1305

vrf management

Defines the management **VRF**¹ instance.

vrf NAME

Specify the user-defined VRF instance name.

Default

Refer to [ssh server default algorithm \(page 307\)](#).

Command Mode

Configure mode

Applicability

Introduced in OcNOS version 6.5.3.

Example

To configure the specific encryption algorithm, execute the following command.

¹Virtual Routing and Forwarding

```
OcNOS(config)#ssh server algorithm encryption chacha20-poly1305
OcNOS(config)#ssh server algorithm encryption chacha20-poly1305 vrf management
OcNOS(config)#commit
```

To configure the multiple encryption algorithms, execute the following command.

```
OcNOS(config)#ssh server algorithm encryption 3des-cbc rijndael-cbc aes256-cbc aes128-gcm
OcNOS(config)#ssh server algorithm encryption 3des-cbc rijndael-cbc aes256-cbc aes128-gcm vrf
management
OcNOS(config)#commit
```

To unconfigure the multiple encryption algorithms, execute the following command.

```
OcNOS(config)#no ssh server algorithm encryption 3des-cbc rijndael-cbc aes256-cbc aes128-gcm
OcNOS(config)#no ssh server algorithm encryption 3des-cbc rijndael-cbc aes256-cbc aes128-gcm vrf
management
OcNOS(config)#commit
```

ssh server algorithm kex

Use this command to configure KEX algorithms.

Use `no` parameter to remove the KEX algorithms.

Command Syntax

```
ssh server algorithm kex KEY_NAME vrf (|management|NAME)
no ssh server algorithm kex
```

Parameters

KEY_NAME

Specifies the SSH encryption type as Key exchange.

curve25519-sha256

curve25519-sha256-libssh-org

diffie-hellman-group-exchange-sha1

diffie-hellman-group-exchange-sha256

diffie-hellman-group1-sha1

diffie-hellman-group14-sha1

diffie-hellman-group14-sha256

diffie-hellman-group16-sha512

diffie-hellman-group18-sha512 ecdh-sha2-nistp256 ecdh-sha2-nistp384 ecdh-sha2-nistp521

vrf management

Defines the management **VRF**¹ instance.

vrf NAME

Specify the user-defined VRF instance name.

Default

Refer to [ssh server default algorithm \(page 307\)](#) CLI section.

Command Mode

Configure mode

Applicability

Introduced in OcNOS version 6.5.3.

Example

To configure the specific KEX algorithm, execute the following command.

```
OcNOS(config)#ssh server algorithm kex curve25519-sha256
OcNOS(config)#ssh server algorithm kex curve25519-sha256 vrf management
```

To configure the multiple KEX algorithms, execute the following command.

¹Virtual Routing and Forwarding

```
OcNOS#conf t Enter configuration commands, one per line. End with CNTL/Z.
OcNOS(config)#ssh server algorithm kex diffie-hellman-group-exchange-sha256 diffie-hellman-group14-
sha256 ecdh-sha2-nistp256
OcNOS(config)#ssh server algorithm kex diffie-hellman-group-exchange-sha256 diffie-hellman-group14-
sha256 ecdh-sha2-nistp256 vrf management
OcNOS(config)#commit OcNOS(config)#end
```

To unconfigure the multiple KEX algorithms, execute the following command.

```
OcNOS(config)#no ssh server algorithm kex diffie-hellman-group-exchange-sha256 diffie-hellman-
group14-sha256
OcNOS(config)#no ssh server algorithm kex diffie-hellman-group-exchange-sha256 diffie-hellman-
group14-sha256 vrf management
```

ssh server algorithm mac

Use this command to configure MAC algorithms.

Use `no` parameter to remove the MAC algorithms.

Command Syntax

```
ssh server algorithm mac MAC_NAME vrf (|management|NAME)
no ssh server algorithm mac
```

Parameters

mac

Specifies the SSH encryption type as MAC exchange.

hmac-sha1
hmac-sha1-96
hmac-sha2-256
hmac-sha2-512
hmac-md5
hmac-md5-96
umac-64@openssh.com
umac-128@openssh.com
hmac-sha1-etm@openssh.com
hmac-sha1-96-etm@openssh.com
hmac-sha2-256-etm@openssh.com
hmac-sha2-512-etm@openssh.com
hmac-md5-etm@openssh.com
hmac-md5-96-etm@openssh.com
umac-64-etm@openssh.com
umac-128-etm@openssh.com

vrf management

Defines the management **VRF**¹ instance.

vrf NAME

Specify the user-defined VRF instance name.

Default

Refer to [ssh server default algorithm \(page 307\)](#).

Command Mode

Configure mode

Applicability

Introduced in OcNOS version 6.5.3.

¹Virtual Routing and Forwarding

Example

To configure the specific MAC algorithm, execute the following command.

```
OcNOS(config)#ssh server algorithm mac hmac-sha2-256
OcNOS(config)#ssh server algorithm mac hmac-sha2-256 vrf management
```

To configure the multiple MAC algorithms, execute the following command.

```
OcNOS(config)#ssh server algorithm mac hmac-sha2-512 umac-128-etm hmac-md5-96-etm hmac-sha2-256-etm
hmac-sha1-etm
OcNOS(config)#ssh server algorithm mac hmac-sha2-512 umac-128-etm hmac-md5-96-etm hmac-sha2-256-etm
hmac-sha1-etm vrf management
```

To modify the MAC algorithm for user defined VRF, execute the following command.

```
OcNOS(config)#ssh server algorithm mac hmac-md5-96-etm hmac-sha2-256 hmac-sha2-512-etm vrf VRF1
OcNOS(config)#ssh server algorithm encryption 3des-cbc vrf VRF1
OcNOS(config)#ssh server algorithm kex diffie-hellman-group-exchange-sha1 diffie-hellman-group14-
sha256 vrf VRF1
```

show ssh server algorithm

Use this command to display the current SSH algorithm policy configured.

Use `no` parameter to remove the default encryption algorithms.

Command Syntax

```
show ssh server algorithm
```

Parameters

None

Default

None

Command Mode

Execution mode

Applicability

Introduced in OcNOS version 6.5.3.

Example

To view the ssh key configured, execute the following command.

```
OcNOS#sh ssh server algorithm
vrf management ssh server algorithm: KexAlgorithms curve25519-sha256

MACs hmac-sha2-256,hmac-sha2-512,umac-128@openssh.com,hmac-sha2-256-etm@openssh.com,hmac-sha2-512-
etm@openssh.com

Default vrf ssh server algorithm:

KexAlgorithms curve25519-sha256

MACs hmac-sha2-256,hmac-sha2-512,umac-128@openssh.com,hmac-sha2-256-etm@openssh.com,hmac-sha2-512-
etm@openssh.com
```

ssh server default algorithm

Use this command to configure default strong SSH encryption algorithms. This command reset the existing algorithms.

Use `no` parameter to remove the default strong SSH encryption algorithms.

Command Syntax

```
ssh server default algorithm (vrf (NAME|management)|)
```

Parameters

vrf management

Defines the management **VRF**¹ instance.

vrf NAME

Specify the user-defined VRF instance name.

Default

None

Command Mode

Configure mode

Applicability

Introduced in OcNOS version 6.5.3.

Example

```
OcNOS#configure terminal OcNOS#ssh server default algorithm
```

¹Virtual Routing and Forwarding

ssh server port

Use this command to set the port number on which the SSH server listens for connections. The default port on which the SSH server listens is 22.

Use the **no** form of this command to set the default port number (22).

Command Syntax

```
ssh server port <1024-65535> (vrf (NAME|management) |)
no ssh server port (vrf (NAME|management) |)
```

Parameters

<1024-65535>

Port number

vrf management

Defines the management **VRF**¹ instance.

vrf NAME

Specify the user-defined VRF instance name.

Default

By default, SSH server port is 22.

Command Mode

Configure mode

Applicability

This command was introduced before OcNOS version 1.3.

Examples

```
#configure terminal
(config)#ssh server port 1720
```

¹Virtual Routing and Forwarding

ssh server session-limit

Use this command to limit number of SSH sessions. Only 40 sessions allowed including Telnet and SSH.

Use `no` form of this command to set to default value.



Note: Few Terminal application (Ex: MobaXterm) where user run SSH Client has limits to use this SSH session limit option.

Command Syntax

```
ssh server session-limit <1-40> (vrf (NAME|management)|)
no ssh server session-limit (vrf (NAME|management)|)
```

Parameters

<1-40>

Number of sessions

vrf management

Defines the management **VRF**¹ instance.

vrf NAME

Specify the user-defined VRF instance name.

Default

By default, 40 sessions are allowed.

Command Mode

Configure mode

Applicability

This command was introduced in OcNOS version 4.2 Added parameter NAME in OcNOS version 6.5.3.

Examples

```
#configure terminal
(config)#ssh server session-limit 4 vrf management
```

¹Virtual Routing and Forwarding

username sshkey

Use this command to add public key of the ssh clients to perform password-less login into the switch.

Command Syntax

```
username USERNAME sshkey LINE
```

Parameters

USERNAME

User identifier

LINE

Digital System Algorithm (DSA) key or Rivest, Shamir, and Adelman (RSA) key in OpenSSH format; this key is written to the `authorized_keys` file

Default

By default, SSHKEY is 1024.

Command Mode

Configure mode

Applicability

This command was introduced before OcNOS version 1.3.

Examples

```
#configure terminal
(config)#username fred
(config)#username fred sshkey
ssh-rsa AAAAB3NzaC1kc3MAAAEBAIirweZzCdyITqbMWB8Wly9ivGxYlJBVnWTVtcWKi6uc
CPZyw3I6J6/+69LEkPUSAYo+SK8zj0NF2f25FFc2YDMh1KKHi5gK7iXF3/ran54j
nP2byyLeo8rnuVqfEDLaBilqQaWBcDQvsZc14t5SEJfsOQSfR03PDqPYAisrZRvM
5pWfzo486Rh33J3+17OuARQtZFDp4wA5zZoFxl4U3RK42JzKNUiYBDrH3lSgfkv
XLWLXz9WcxY6zuKvXFwUpOA9PRXwUsKQqWuyyWZQLNavENqFyoQ8oZnNKLCYE0h8
QnUe62NGxb3jQXKLf1LOL04JFNiii9sACG1Y/ut4ANysAAAVAJbM7Z4chRgiVahN
iwXFJnkBmWGZAAABAAuF1FlI6xy0L/pBaIlFw34uUL/mh4SR2Di2X52eK70VNj+m
y5eQdRC6cxpaVqpS3Q4xTN+W/kaBbIlX40xJP5lcmVfn/nqiuIeEodmVIJMWxOD
fh3egeGuSW614Vzd1RGrxpYInIoygmULRcxhmbX+rPliuUIvhg36iH0UR7XBln6h
uyKFvEmaL7bG1RvELjqaj0y6iicfPlyGBc5vavH5X+jOWqdsJHsCgcIzPF5D1Ybp
w0nZmGsqO+P55mjMuj002uI7NslsxyirbnGhd+ZZ1u03QDy6MBcUspai8U5CIe6X
WqvXY+yJjpuv1W9GTHowCcGd6Z/e9IC6VE/kNEAAAAEAFIe6kLGTALR0F3AfapYY
/M+bvkmkkh0JUzVdLiwMjcvTJb9fQpPxxXE1S3ZvUNIEE1UPS/V7KgSsj8eg3FKN
iUGICkTwHIK7RTLc8k4IE6U3V3866JtxW+Znv1DB7uwnbZgoIZuVt3r1+h800ah8
UKwDUMJT0fwu9cuuS3G8Ss/gKi1HgByrcxXoK51/r4Bc4QmR2VQ8sXOREv/SHJeY
JGbEX30xjRgXC7G1pbdrPiL8zs0dPiZ0ovAswsBOY1KYhd7JvfCcvWRjgP5h55aw
GNSmNs3STKufbIqYGeDAISYNY4F2JzR593KIBnWgyhokyYybyEBh8NwTTO4J5rT
ZA==
```

username keypair

Use this command to generate the key for users.

Command Syntax

```
username USERNAME keypair rsa
username USERNAME keypair dsa
username USERNAME keypair rsa length <1024-4096>
username USERNAME keypair rsa length <1024-4096> force
username USERNAME keypair rsa force
username USERNAME keypair dsa force
```

Parameters

USERNAME

User identifier

rsa

Rivest, Shamir, and Adelman (RSA) public-key cryptography SSH server key

dsa

Digital System Algorithm (DSA) SSH key

<1024-4096>

Number of bits to use when creating the SSH server key; this parameter is only valid for RSA keys (DSA keys have a default length of 1024)

force

Forces the replacement of an SSH key

Default

DSA keys have a default value of 1024.

RSA keys have a minimum key length of 1024 bits and the default length is 4096.

By default the system has RSA/DSA public/private key pair placed in /etc/ssh/. The force option is used if the user wants to regenerate the ssh rsa keys. The same thing applies for dsa also.

Command Mode

Execution mode

Applicability

This command was introduced before OcNOS version 1.3.

Examples

```
#configure terminal
(config)#username fred keypair rsa
```

| USER MANAGEMENT CONFIGURATION

User Config AES Encryption	313
Overview	313
Feature Characteristics	313
Benefits	313
Configuration	313
global key-encryption	315
show global key-encryption	316
Using the Management Interface	317
Overview	317
Management Port	317
In-Band Ports	319
User Configuration	321
Overview	321
User Configuration	321
Configurable Password Policy	323
Overview	323
Configuration	324
Implementation Examples	325
max-password-age	326
Removing Users with Expired Passwords	327
New CLI Commands	328
Stronger User Password Hashes	341
Overview	341
Feature Characteristics	341
Benefits	341
Configuration	341
Implementation Examples	343
CLI Commands	343
user password encryption default	343
show user password encryption	344
Parameters	344

User Config AES Encryption

Overview

Sensitive information, such as authentication keys configured in plain text, is stored in the OcNOS database in an encrypted format. Currently, by default, this information is encrypted using the 3DES algorithm. With this new feature, users will have the option to store sensitive information encrypted using the Advanced Encryption Standard (AES) algorithm. It ensures confidentiality and integrity in routing protocols like BGP, OSPF, RIP, IS-IS, LDP, BFD, MSDP, and Radius authentication.

Feature Characteristics

- Users can choose to encrypt sensitive information using either the 3DES or AES algorithm.
- Global configuration allows users to select the preferred encryption algorithm for data stored within the OcNOS database.
- If sensitive data is already encrypted, OcNOS accepts both AES and 3DES-encrypted data.
 - AES-encrypted data must be encrypted by OcNOS, as it adds a tag to differentiate AES from 3DES-encrypted data.
- Users can change the global encryption algorithm at any time without affecting previously configured sensitive data.
 - OcNOS maintains internal control over the encryption algorithm used for each piece of sensitive data.
- If no encryption algorithm is specified by the user, OcNOS defaults to using the 3DES algorithm, preserving the existing behavior.

Benefits

This feature enhance security by using AES 256-bit encryption with Galois/Counter Mode(GCM).

Configuration

These steps provide a standardized approach to configuring AES Encryption across different routing protocols. These configurations ensure that sensitive routing data is encrypted and secure, protecting network infrastructure from malicious threats.

Configuration Snapshot:

BGP configuration:

3DES encryption algorithm:

```
router bgp 100
neighbor 10.10.10.11 remote-as 200
neighbor 10.10.10.11 authentication-key 0xb376ebccbde0bb44ebba6c415d533683
```

AES encryption algorithm:

```
router bgp 100
neighbor 10.10.10.11 remote-as 200
```



```
neighbor 10.10.10.11 authentication-key
0x25fdc4e11aaf5d9caa36b6a904ad7ec476dca3447b42486c119032b2b06e7c1daf8bfde097ed
```

OSPF configuration:**3DES encryption algorithm:**

```
interface xe49
ip ospf message-digest-key 1 md5 0xebe3bd4b01e1198ff808f31af4a0adf1
```

AES encryption algorithm:

```
interface xe1
ip ospf message-digest-key 1 md5
0xc5cf7a352927208c029d58dec379f7459207509788ff04311b04a8ccc06f4eb95171b28fa6
```

RIP Configuration**3DES encryption algorithm:**

```
interface xe2
ip rip authentication mode md5
ip rip authentication string 0xebe3bd4b01e1198ff808f31af4a0adf1
```

AES encryption algorithm:

```
interface xe1
ip rip authentication mode md5
ip rip authentication string
0x528bd88845782cf7595bfb2c60742358f980a733bb208276b60f6e184fcb239724c4585152
```

IS-IS Key-Chain authentication**3DES encryption algorithm:**

```
key chain TEST
key-id 1
key-string encrypted 0xebe3bd4b01e1198ff808f31af4a0adf1
```

AES encryption algorithm:

```
key chain TEST
key-id 1
key-string encrypted 0x93f3323b28293e577235b61aef68418931fa74095b20f5aa989aceadb3b5cdda45d004e5ab
LDP MD5 authentication
```

LDP MD5 authentication**3DES encryption algorithm:**

```
router ldp
neighbor all auth md5 password encrypt 0x93c51ab33976afff
session-group name 1
auth md5 password encrypt 0x93c51ab33976afff
```

AES encryption algorithm:

```
router ldp
neighbor all auth md5 password encrypt
0x7b34695900344ff981d097ca3b76d3f7602c97533ae71fb5a24f6f63b5a1b36a0a2e11f5
session-group name 1
auth md5 password encrypt 0x7b34695900344ff981d097ca3b76d3f7602c97533ae71fb5a24f6f63b5a1b36a0a2e11f5
```

BFD authentication**3DES encryption algorithm:**

```
interface eth1
bfd auth type simple key-id 100 1 key 0xb376ebccbde0bb44ebba6c415d533683
```

AES encryption algorithm:

```
interface eth1
bfd auth type simple key-id 100 1 key
0x25fdc4e11aaf5d9caa36b6a904ad7ec476dca3447b42486c119032b2b06e7c1daf8bfde097ed
```

MSDP**3DES encryption algorithm:**

```
ip msdp peer 1.1.1.1
ip msdp password 0x93c51ab33976afff9c2308c1131e52b8 peer 1.1.1.1
```

AES encryption algorithm:

```
ip msdp peer 1.1.1.1
ip msdp password 0x2bf091e584673fda07def61c29a16ac38ceff092e11fe75d12122fb6d4683b1bfa8d8379f1de peer
1.1.1.1
```

Radius authentication**3DES encryption algorithm:**

```
radius-server login key 7 0xf6fe51115a8718c8541a2369d0222f7f
radius-server login host 10.3.4.17 seq-num 7 key 7 0x923502641e0b7d352b09d097ceb464da auth-port 4567
timeout 40
```

AES encryption algorithm

```
radius-server login key 7 0x1c5c4abfd0cb21baf4d1980261f16f2f9dad69fc5e732b322f6d9c764f864f696ee7668e1f7a
radius-server login host 10.3.4.17 seq-num 7 key 7
0x35404c0de9ca6cb64531aad49b8d7ebf64550c4d52d0201e423f7de5227ccb5c52d8242b12bd auth-port 4567 timeout 40
```

Validation

Execute the following command to verify the global key-encryption:

```
OcNOS#show global key-encryption
Current global key-encryption in use is AES.
OcNOS#
```

Implementation Examples

To choose which global cipher algorithm will be used by OcNOS, the user simply runs the following command:

```
OcNOS(config)#global key-encryption AES
OcNOS(config)#commit
OcNOS(config)#
```

The configuration will appear in show running-config:

```
OcNOS#sh ru
!
...
global key-encryption AES
...
!
end
OcNOS#
```

global key-encryption

Use this command to configure the global cipher algorithm.

Use `no` parameter of this command to unconfigure the global cipher algorithm for OcNOS.

Command Syntax

```
global key-encryption (3DES|AES)
[no] global key-encryption
```

Parameters

key-encryption (3DES|AES)

Specifies the cipher algorithm to be used by OcNOS

Default

3DES encryption

Applicability

This command was introduced in OcNOS 6.6.0 version.

Example

```
OcNOS(config)#global key-encryption AES
```

show global key-encryption

Use this command to show global key-encryption.

Command Syntax

```
show global key-encryption
```

Parameters

None

Default

3DES encryption

Applicability

This command was introduced in OcNOS 6.6.0 version.

Example

```
OcNOS#show global key-encryption
Current global key-encryption in use is AES.
OcNOS#
```

Using the Management Interface

Overview

OcNOS provides support for different types of Management Interfaces. The management interface can be the standard out of band (OOB) port, or any in-band port.

To provide segregation between management traffic and data traffic, OcNOS provides a Management **VRF**¹. The Management VRF is created by default when OcNOS boots. This VRF cannot be deleted. All ports used as Management Interface needs to be in Management VRF. The management VRF is used for all types of Management applications listed below

- Remote access to router (SSH/Telnet)
- File transfer applications (SFTP/SCP)
- Login Authentication via Radius/Tacacs
- Network management protocols (SNMP, Netconf)

Apart from this, **DHCP**², DNS, NTP, Syslog, **sFlow**³, and license/software upgrade also uses ports mapped to the management VRF for their operations. Also LLDP can run on any ports mapped to the management VRF.



Note: If the management interface flaps, the device becomes unreachable.

Management Port

The Out of Band (OOB) Management Port in OcNOS is identified as “eth0.” This port is automatically mapped to the Management **VRF**⁴ when OcNOS boots, and will remain in same VRF throughout. It cannot be moved out of this VRF.

The IP address of the management port can be configured statically or via **DHCP**⁵.

Static IP Configuration

A static IP can be configured on the management port during ONIE installation itself, or after installation using the OcNOS CLIs commands. To configure a static IP during ONIE installation, do the following

```
#onie-stop  
#ifconfig eth0 <ip address> netmask <subnet mask> up
```

Please check the Install Guide for details.

¹Virtual Routing and Forwarding

²Dynamic Host Configuration Protocol

³Sampled Flow data sFlow (sFlow) is the standard for monitoring high-speed switched and routed networks. The sFlow monitoring system consists of an sFlow Agent which is embedded in a switch or router and an sFlow Collector.

⁴Virtual Routing and Forwarding

⁵Dynamic Host Configuration Protocol

The IP address configured during ONIE installation will be applied to the management port and the same will be retained when OcnOS boot up, and the port becomes part of Management VRF.

```
#show running-config interface eth0
!
interface eth0
 ip vrf forwarding management
 ip address 10.12.44.109/24
```

After getting the OcnOS prompt, this IP address can be changed from the CLI.

#configure terminal	Enter configure mode
(config)#interface eth0	Enter interface mode
(config-if)#ip address 10.12.44.120/24	Assign an IPv4 address to the interface
(config-if)#exit	Exit interface mode
(config)#commit	Commit the candidate configuration to the running configuration
(config)#exit	Exit configure mode

If a static IP is not configured during ONIE installation the same can be configured via CLI by following the above steps. Using the OcnOS CLI, DHCP can also be enabled on the Management port.

#configure terminal	Enter configure mode
(config)#interface eth0	Enter interface mode
(config-if)#ip address dhcp	Enable DHCP on interface
(config-if)#exit	Exit interface mode
(config)#commit	Commit the candidate configuration to the running configuration
(config)#exit	Exit configure mode

Obtaining IP Address via DHCP

During onie installation, the management port attempts to acquire IP address via DHCP automatically unless stopped explicitly using the `onie-stop` command. So, if management port is getting IP via DHCP, after OcnOS boots, the management port will continue to use DHCP, even when it is part of the Management VRF.

```
#show running-config interface eth0
!
interface eth0
 ip vrf forwarding management
 ip address dhcp
```

After OcnOS boots, the IP address can be changed to any static IP from the command line as shown earlier.

In-Band Ports

Any front-end ports of the device (in-band ports) can be made part of the management **VRF**¹. Once they are part of the management VRF they can also support all management applications such as SSH/Telnet and others as listed in [Overview \(page 317\)](#).

Once the ports are part of the management VRF, they should not be used for data traffic and routing or switching purposes. In-band ports can be added or removed from Management VRF as and when required.

#configure terminal	Enter configure mode
(config)#interface xe1/1	Enter interface mode
(config-if)#ip vrf forwarding management	Add in-band port to Management VRF
(config-if)#exit	Exit interface mode
(config)#commit	Commit the candidate configuration to the running configuration
(config)#exit	Exit configure mode
<hr/>	
#configure terminal	Enter configure mode
(config)#interface xe1/1	Enter interface mode
(config-if)# no ip vrf forwarding management	Remove in-band port from Management VRF
(config-if)#exit	Exit interface mode
(config)#commit	Commit the candidate configuration to the running configuration
(config)#exit	Exit configure mode

Using Ping in Management VRF

To check reachability to any node in the management network, you need to explicitly mention the VRF name as “management.”

In the following example, Node-1 has management interface eth0 and Node-2 has management interfaces eth0 and xe3/1. In order to reach the network 20.20.20.0/24 from Node-1 a static route needs to be added.

Figure 17. Ping in Management VRF topology

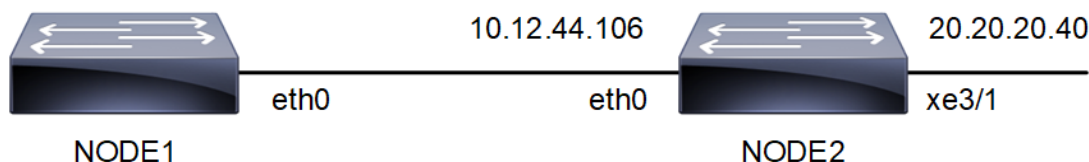

#configure terminal	Enter configure mode
(config)# ip route vrf management 20.20.20.0/24 10.12.44.106 eth0	Add static route in management VRF to reach 20.20.20.0/24 network

¹Virtual Routing and Forwarding

(config)#commit	Commit the candidate configuration to the running configuration
(config)#exit	Exit configure mode

```
Node-1#show ip route vrf management
Codes: K - kernel, C - connected, S - static, R - RIP, B - BGP
       O - OSPF, IA - OSPF inter area
       N1 - OSPF NSSA external type 1, N2 - OSPF NSSA external type 2
       E1 - OSPF external type 1, E2 - OSPF external type 2
       i - IS-IS, L1 - IS-IS level-1, L2 - IS-IS level-2, ia - IS-IS inter area,
       v - vrf leaked
       * - candidate default

IP Route Table for VRF "management"
C      10.12.44.0/24 is directly connected, eth0
S      20.20.20.0/24 [1/0] via 10.12.44.106, eth0

Gateway of last resort is not set

Node-1#ping 20.20.20.40 vrf management
PING 20.20.20.40 (20.20.20.40) 56(84) bytes of data.
64 bytes from 20.20.20.40: icmp_seq=1 ttl=64 time=0.494 ms
64 bytes from 20.20.20.40: icmp_seq=2 ttl=64 time=0.476 ms
```

User Configuration

Overview

User management is an authentication feature that provides administrators with the ability to identify and control the users who log into the network.

OcNOS provides 4 different roles for users.

- **Network Administrator:** Can make permanent changes to the switch configuration. Changes are persistent across reset or reboot of switch.
- **Network Engineer:** Can make permanent changes to the switch configuration. Changes are persistent across reset or reboot of switch.
- **Network Operator:** Can make permanent changes to the switch configuration. Changes are not persistent across reset or reboot of switch.
- **Network User:** Can display information but cannot modify the configuration.

User Configuration

<code>#configure terminal</code>	Enter configure mode.
<code>(config)#username user1 password User12345\$</code>	Create a user <code>user1</code> with password <code>User12345\$</code> with default role of network user. Password must be 8-32 characters, username 2-15 characters.
<code>(config)#username user1 role network-operator password User12345\$</code>	Change the role for <code>user1</code> to network-operator.
<code>(config)#username user2 role network-operator password User12345\$</code>	Create a user <code>user2</code> with role as network-operator.
<code>(config)#username user3 role network-admin password User12345\$</code>	Create a user <code>user3</code> with role as network-admin.
<code>(config)#username user4 role network-engineer password User12345\$</code>	Create a user <code>user4</code> with role as network-engineer.
<code>(config)#commit</code>	Commit the candidate configuration to the running configuration
<code>(config)#exit</code>	Exit configure mode.

Validation

```
#show user-account
User:user1
      roles: network-operator
User:user2
      roles: network-operator
User:user3
      roles: network-admin
User:user4
      roles: network-engineer

#show role
```



```
Role Name                               Info
-----
network-admin                           Network Administrator - Have all permissions
network-engineer                         Network Engineer - Can save configuration
network-operator                         Network Operator - Can not save configuration
network-user                             Network User - Can not change configuration
rbac-customized-role                    RBAC User - Can change only permitted configuration

#show user-account user1
User:user1
      roles: network-operator
```

Configurable Password Policy

Overview

A password is a sequence of characters utilized to confirm a user's identity in the authentication procedure. A strong password helps to protect user accounts and prevents unauthorized access. Strong passwords are the first defense against cyberattacks. Hackers commonly use automated tools to crack passwords. Weak passwords are easily guessed or cracked. Every organization encourages its users to use long passwords combining alphanumeric and special characters. A lengthy password is more complex for hackers, who also need to invest a lot of time to hack the system.

OcNOS manages the user account and its password in its OcNOS configuration, then their password is reflected to LINUX standard user management db, `/etc/passwd` and `/etc/shadow`.

The password expiration settings in OcNOS and in the standard user management system in LINUX are not always identical. Since the operation of the OcNOS shell is not the same as that of standard shells like bash, similar mechanisms must be implemented in the OcNOS shell to enforce default password changes and set expiration dates.

Feature Characteristics

Setting up strong passwords safeguards sensitive data associated with user accounts, including those of employees and customers, against unauthorized access.

Integrating PAM to OcNOS

Privileged Access Management (**PAM**¹) is a third party pluggable security tool that protects organizations from cyberthreats by overseeing, detecting, and thwarting unauthorized privileged access to vital resources.

To satisfy customer requirements, use `pam_pwquality` or `pam_history`, standard PAM modules in LINUX. These are more optimal than implementing a custom password-strength verification system within this system.

When a user sets a password in plain text, it is immediately hashed, and from then on, this hashed password is used for internal management to save settings. The plain text password is not stored anywhere. However, the verification of password strength through PAM is only possible with the plain text password, hence verification can only be conducted while the plain text password is available.

In OcNOS, an actual password change is not performed while the plain text password is held. When a 'commit' operation is executed, it is saved until 'write' operation is executed. However, since PAM cannot verify the strength of a password without setting it, OcNOS temporarily sets the password and while holds the plain text password to check if the new password meets the password policy and can be changed. If it meets the policy and the password is changed, a process is necessary to revert to the original password.

PAM modules are configured in `/etc/security/pwquality.conf` and `/etc/pam.d/common_password`. This system internally holds default values based on customer requirements and sets them in these files at system startup. These files are updated if the corresponding configuration values are changed through the CLI and prompts user to update the default password.

To update these default passwords, check if the encrypted password calculated by its username and then prompt the user to update the password. Since the user 'OcNOS' shell is 'cmlsh' and the 'root' shell is 'bash', this code is

¹Privileged Access Management is a third party pluggable security tool that protects organization from cyberthreats by overseeing.

developed independently. For the OcNOS user, it is implemented in `cmlsh_start()` in `cmlsh_main`. For the root user, it is done in `/root/.bash`

Benefits

- Strong passwords protect user accounts and devices from unauthorized access and safeguard sensitive information.
- If the passwords are complex, data is safe from cyber threats and hackers.

Configuration

The OcNOS configuration triggers all user management or password updates including LINUX accounts.

The below configurations allow the user to authenticate the password policy.

Topology

Use the OcNOS interface to configure user accounts, such as creating, disabling passwords and maintain user accounts information.

The image illustrates a method for authenticating and authorizing user account passwords.

Figure 18. OcNOS



OcNOS Device

1. Enable the aaa local authentication password-policy.

```
OcNOS#configure terminal
OcNOS(config)#aaa local authentication password-policy
OcNOS(config)#commit
```

2. Configure the aaa local authentication password-policy parameter to perform the below actions.

```
OcNOS (config)#aaa local authentication password-policy disable-usercheck
OcNOS (config)#aaa local authentication password-policy history 10
OcNOS (config)#aaa local authentication password-policy lowercase-count 3
OcNOS (config)#aaa local authentication password-policy maxrepeat 2
OcNOS (config)#aaa local authentication password-policy maxsequence 3
OcNOS (config)#aaa local authentication password-policy min-length 10
OcNOS (config)#aaa local authentication password-policy numeric-count 3
OcNOS (config)#aaa local authentication password-policy special-count 3
OcNOS (config)#aaa local authentication password-policy uppercase-count 2
```

Validation 1

Before enabling the local authentication password-policy.

```
# show aaa authentication password-policy

Password policy parameter:

Password policy feature: Disabled
Minimum number of digit: 1
Minimum number of uppercase character: 1
Minimum number of lowercase character: 1
Minimum number of special character: 1
Allowed the number of monotonic character sequences: 5
Username check: Enabled
Allowed the number of same consecutive characters: 1
Minimum length of password: 8
Number of remembered passwords: 5
```

After enabling the local authentication password-policy.

```
#show running-config

aaa local authentication password-policy

#show aaa authentication password-policy

Password policy parameter:
Password policy feature: Enabled
Minimum number of digit: 1
Minimum number of uppercase character: 1
Minimum number of lowercase character: 1
Minimum number of special character: 1
Allowed the number of monotonic character sequences: 5
Username check: Enabled
Allowed the number of same consecutive characters: 1
Minimum length of password: 8
Number of remembered passwords: 5
```

Validation 2

```
#show aaa authentication password-policy

Password policy parameter:
Password policy feature: Enabled
Minimum number of digit: 3
Minimum number of uppercase character: 2
Minimum number of lowercase character: 3
Minimum number of special character: 3
Allowed the number of monotonic character sequences: 3
Username check: Disabled
Allowed the number of same consecutive characters: 2
Minimum length of password: 10
Number of remembered passwords: 10
```

Implementation Examples

Set own password policy parameter and enter the password not as per the password-policy.

```
OcNOS(config)#username OcNOS role network-admin password Testing@123
```

BAD PASSWORD: The password contains less than 2 uppercase letters.

%% The password is too weak.

Password-policy logs

```
OcNOS(config)#username OcNOS role network-admin password T3$$Ting@123
```

```
OcNOS (config) #commit
OcNOS (config) #
```

Based on the above configuration set the password in the below format:

- Uppercase characters: 2
- Lowercase characters:3
- Special characters:3
- Numerical characters: 3
- Total Password length: 12

max-password-age

The maximum age for a user password for OcNOS is 60 days. The password policy setting describes how long users can use their password before it expires. This helps the users periodically change their passwords. When a user's password is updated, the expiry is set according to the user's role. This can be modified or updated per user. Once the expiry is set at the user level, the system will check for user-level expiry.

When a user logs in and cmlsh is invoked for the admin user, the admin user is prompted to change the password. A non-admin receives a message to contact the admin to update the password. If the user password has expired and it is not updated within the next 30 days, the user account removed from the database.

All these features are enabled and disabled entirely with a CLI. When disabled, /etc/pam.d/common-password should be updated not to use both pam_pwquality and pam_pwhistory modules.

Configuration

The below configurations allow the user to authenticate the maximum password age.

OcNOS Device

1. Enable the aaa local authentication password-policy

```
OcNOS#configure terminal
OcNOS (config) #aaa local authentication password-policy
OcNOS (config) #commit
```

2. Configure the aaa local authentication password expire for user and role

```
OcNOS (config) #aaa local authentication expire 40 role network-admin
OcNOS (config) #aaa local authentication expire 45 role network-engineer
OcNOS (config) #aaa local authentication expire 35 role network-operator
OcNOS (config) #aaa local authentication expire 50 role network-user
OcNOS (config) #aaa local authentication expire 50 user Test1
OcNOS (config) #commit
```



Note: The password will not expire, if we select the number of days as 0.

Validation 1

Before enabling the `local authentication password-policy`.

```
#show aaa authentication password-policy
Password policy parameter:
Minimum number of digit: 1
```

```
Minimum number of uppercase character: 1
Minimum number of lowercase character: 1
Minimum number of special character: 1
Allowed the number of monotonic character sequences: 5
Username check: Enabled
Allowed the number of same consecutive characters: 1
Minimum length of password: 8
Number of remembered passwords: 5
network-admin expiration days: Disabled
network-engineer expiration days: Disabled
network-operator expiration days: Disabled
network-user expiration days: Disabled
```

After enable the **local authentication password-policy**.

By default, password expire is enable as well

```
#show aaa authentication password-policy
Password policy parameter:
Password policy feature: Enabled
Minimum number of digit: 1
Minimum number of uppercase character: 1
Minimum number of lowercase character: 1
Minimum number of special character: 1
Allowed the number of monotonic character sequences: 5
Username check: Enabled
Allowed the number of same consecutive characters: 1
Minimum length of password: 8
Number of remembered passwords: 5
network-admin expiration days: 30
network-engineer expiration days: 60
network-operator expiration days: 60
network-user expiration days: 60
```

After configuring the password expire for role and user.

```
#show aaa authentication password-policy
Password policy parameter:
Password policy feature: Enabled
Minimum number of digit: 1
Minimum number of uppercase character: 1
Minimum number of lowercase character: 1
Minimum number of special character: 1
Allowed the number of monotonic character sequences: 5
Username check: Enabled
Allowed the number of same consecutive characters: 1
Minimum length of password: 8
Number of remembered passwords: 5
network-admin expiration days: 40
network-engineer expiration days: 45
network-operator expiration days: 35
network-user expiration days: 50
Test1: will expire in 50 days!!!
```

Removing Users with Expired Passwords

When a user's password is updated, the on set depending on the user's role. This is modified per user. Once the expiry is set, the system will automatically check for expired passwords. When a user logs in and `cmlsh` is invoked, for the admin user the user will be prompted to change the password. A non-admin user will receive a message to contact the admin to update the password.

If the user is expired and never update password or expiry for next 30 days, that user is removed from the database. All these features are enabled or disabled entirely with a CLI. When disabled, /etc/pam.d/common-password needs to be updated but not to use both pam_pwquality and pam_pwhistory modules.



Note: When updating a user’s level expiry, any days already lapsed are deducted from the new expiry value. If the updated value is greater than the remaining days, it becomes the new remaining days. For example, if a user initially has 20 days and, after 5 days, the expiry is updated to 30 days, the user will have 25 days left (30 - 5). Conversely, if the expiry is updated to 10 days after 5 days have passed, the remaining time is set to 10 days.

Glossary

Key Terms/Acronym	Description
PAM ¹	Privileged Access Management s a third party pluggable security tool that protects organization from cyberthreats by overseeing.

New CLI Commands

The **configurable password policy** introduces the following configuration commands.

aaa authentication password-policy	329
aaa local authentication password-policy	330
aaa local authentication password expire role	330
aaa local authentication password expire user	331
aaa local authentication password-policy disable-usercheck	332
aaa local authentication password-policy history	333
aaa local authentication password-policy lowercase-count	334
aaa local authentication password-policy maxrepeat	335
aaa local authentication password-policy maxsequence	336
aaa local authentication password-policy min-length	337
aaa local authentication password-policy numeric-count	338
aaa local authentication password-policy special-count	339
aaa local authentication password-policy uppercase-count	340

¹Privileged Access Management is a third party pluggable security tool that protects organization from cyberthreats by overseeing.

aaa authentication password-policy

Use this command to verify the output for password-policy.

Command Syntax

```
show aaa authentication password-policy
```

Parameters

None

Default

None

Command Mode

Privilege mode

Applicability

Introduced in OcNOS version 6.5.1.

Example

```
OcNOS# show aaa authentication password-policy

Password policy parameter:

Password policy feature: Enabled
Minimum number of digit: 1
Minimum number of uppercase character: 1
Minimum number of lowercase character: 1
Minimum number of special character: 1
Allowed the number of monotonic character sequences: 5
Username check: Enabled
Allowed the number of same consecutive characters: 1
Minimum length of password: 8
Number of remembered passwords: 5
```

aaa local authentication password-policy

Use this command to enable/disable the password-policy.

Use no parameter of this command to disable.

Command Syntax

```
aaa local authentication password-policy
no aaa local authentication password-policy
```

Parameters

None

Default

The aaa local authentication password-policy is disabled under authentication password policy.

Command Mode

Configure mode

Applicability

Introduced in OcNOS version 6.5.1.

Example

```
OcNOS#configure terminal
OcNOS(config)#aaa local authentication password-policy
OcNOS(config)#commit
```

aaa local authentication password expire role

Use this command to enable or disable the password expire for role.

Use no parameter of this command to disable.

Command Syntax

```
aaa local authentication password expire <0-1000> role (network-admin|network-engineer|network-
operator|network-user)
no aaa local authentication password expire role (network-admin|network-engineer|network-
operator|network-user)
```

Parameters

expire <0-1000>

Specifies the number of days for password expiry for a particular role.

role network-admin

Specifies the network administration role for which the configured password expiry days are applicable.

role network-engineer

Specifies the network engineer role for which the configured password expiry days are applicable.

role network-operator

Specifies the network operator role for which the configured password expiry days are applicable.

role network-user

Specifies the network user role for which the configured password expiry days are applicable.

Default

Disabled

Command Mode

Configure mode

Applicability

Introduced in OcNOS version 6.5.3.

Example

```
OcNOS#configure terminal
OcNOS(config)#aaa local authentication password expire 50 role network-admin
OcNOS(config)#commit
```

aaa local authentication password expire user

Use this command to enable or disable the password expire for role.

Use no parameter of this command to disable.

Command Syntax

```
aaa local authentication password expire <0-1000> user WORD
no aaa local authentication password expire user WORD
```

Parameters**expire <0-1000>**

Specifies the number of days for password expiry for a particular user.

user WORD

Specifies the user name.

Default

Disabled

Command Mode

Configure mode

Applicability

Introduced in OcNOS version 6.5.3.

Example

```
OcNOS#configure terminal
OcNOS(config)#aaa local authentication password expire 50 user user test
OcNOS(config)#commit
```

aaa local authentication password-policy disable-usercheck

Use this command to set the enable/disable the username check .

Use no parameter of this command to get the default value.

Command Syntax

```
aaa local authentication password-policy disable-usercheck
```

Parameters

<1-400>

Specifies the password disable range

Default

The aaa local authentication password-policy usercheck is enabled under authentication password-policy.

Command Mode

Configure mode

Applicability

Introduced in OcNOS version 6.5.1.

Example

```
OcNOS#configure terminal
OcNOS(config)#aaa local authentication password-policy disable-usercheck
OcNOS(config)#commit
OcNOS#show aaa authentication password-policy
OcNOS(config)# no aaa local authentication password-policy disable-usercheck
OcNOS(config)# commit
OcNOS#show aaa authentication password-policy
```

aaa local authentication password-policy history

Use this command to set the remembered password.

Use no parameter of this command to get the default value.

Command Syntax

```
aaa local authentication password-policy history <1-400>
```

Parameters

<1-400>

Specifies the password history range

Default

The aaa local authentication password-policy history value is 5.

Command Mode

Configure mode

Applicability

Introduced in OcNOS version 6.5.1.

Example

```
OcNOS#configure terminal
OcNOS(config)#aaa local authentication password-policy history 10
OcNOS(config)#commit
OcNOS#show aaa authentication password-policy
OcNOS(config)#no aaa local authentication password-policy history
OcNOS(config)#commit
OcNOS#show aaa authentication password-policy
```

aaa local authentication password-policy lowercase-count

Use this command to set the minimum number of lowercase character.

Use no parameter of this command to get the default value.

Command Syntax

```
aaa local authentication password-policy lowercase-count <1-32>
```

Parameters

<1-32>

Specifies the minimum number of uppercase characters range.

Default

The aaa local authentication password-policy uppercase-count value is 1.

Command Mode

Configure mode

Applicability

Introduced in OcNOS version 6.5.1.

Example

```
OcNOS#configure terminal
OcNOS(config)#aaa local authentication password-policy lowercase-count 2
OcNOS(config)#commit
OcNOS#show aaa authentication password-policy
OcNOS(config)# no aaa local authentication password-policy lowercase-count
OcNOS(config)# commit
OcNOS#show aaa authentication password-policy
```

aaa local authentication password-policy maxrepeat

Use this command to set the same consecutive character.

Use no parameter of this command to get the default value.

Command Syntax

```
aaa local authentication password-policy maxrepeat <1-32>
```

Parameters

<1-32>

Specifies the same consecutive character range.

Default

The aaa local authentication password-policy maxrepeat value is 1.

Command Mode

Configure mode

Applicability

Introduced in OcNOS version 6.5.1.

Example

```
OcNOS#configure terminal
OcNOS(config)#aaa local authentication password-policy maxrepeat 2
OcNOS(config)#commit
OcNOS#show aaa authentication password-policy
OcNOS(config)# no aaa local authentication password-policy maxrepeat
OcNOS(config)# commit
OcNOS#show aaa authentication password-policy
```

aaa local authentication password-policy maxsequence

Use this command to set the number of monotonic character sequence.

Use no parameter of this command to get the default value.

Command Syntax

```
aaa local authentication password-policy maxsequence <1-32>
```

Parameters

<1-32>

Specifies the monotonic character sequences characters range.

Default

The aaa local authentication password-policy maxsequence value is 5.

Command Mode

Configure mode

Applicability

Introduced in OcNOS version 6.5.1.

Example

```
#configure terminal
(config)#aaa local authentication password-policy maxsequence 7
(config)#commit
#show aaa authentication password-policy
(config)# no aaa local authentication password-policy maxsequence
(config)# commit
#show aaa authentication password-policy
```

aaa local authentication password-policy min-length

Use this command to set the minimum length of password.

Use no parameter of this command to get the default value.

Command Syntax

```
aaa local authentication password-policy min-length <8-32>
```

Parameters

<8-32>

Specifies the minimum password length range.

Default

The aaa local authentication password-policy min-length value is 8.

Command Mode

Configure mode

Applicability

Introduced in OcNOS version 6.5.1.

Example

```
OcNOS#configure terminal
OcNOS(config)#aaa local authentication password-policy min-length 10
OcNOS(config)#commit
OcNOS#show aaa authentication password-policy
OcNOS(config)#no aaa local authentication password-policy min-length
OcNOS(config)#commit
OcNOS#show aaa authentication password-policy
```

aaa local authentication password-policy numeric-count

Use this command to set the minimum number of digits.

Use no parameter of this command to get the default value.

Command Syntax

```
aaa local authentication password-policy numeric-count <1-32>
no aaa local authentication password-policy numeric-count <1-32>
```

Parameters

<1-32>

Specifies the numeric count range.

Default

The aaa local authentication password-policy numeric-count value is 1.

Command Mode

Configure mode

Applicability

Introduced in OcNOS version 6.5.1.

Example

```
OcNOS#configure terminal
OcNOS(config)#aaa local authentication password-policy numeric-count 2
OcNOS(config)#commit
OcNOS(#show aaa authentication password-policy
OcNOS(config)# no aaa local authentication password-policy numeric-count
OcNOS(config)# commit
OcNOS#show aaa authentication password-policy
```

aaa local authentication password-policy special-count

Use this command to set the minimum number of special character.

Use no parameter of this command to get the default value.

Command Syntax

```
aaa local authentication password-policy special-count <1-32>
```

Parameters

<1-32>

Specifies the minimum number of special characters range.

Default

The aaa local authentication password-policy special-count value is 1.

Command Mode

Configure mode

Applicability

Introduced in OcNOS version 6.5.1.

Example

```
OcNOS#configure terminal
OcNOS(config)#aaa local authentication password-policy special-count 2
OcNOS(config)#commit
OcNOS#show aaa authentication password-policy
OcNOS(config)# no aaa local authentication password-policy special-count
OcNOS(config)# commit
OcNOS#show aaa authentication password-policy
```

aaa local authentication password-policy uppercase-count

Use this command to set the minimum number of uppercase characters.

Use no parameter of this command to get the default value.

Command Syntax

```
aaa local authentication password-policy uppercase-count <1-32>
```

Parameters

<1-32>

Specifies the uppercase characters count range.

Default

The aaa local authentication password-policy uppercase-count value is 1.

Command Mode

Configure mode

Applicability

Introduced in OcNOS version 6.5.1.

Example

```
OcNOS#configure terminal
OcNOS(config)#aaa local authentication password-policy uppercase-count 2
OcNOS(config)#commit
OcNOS#show aaa authentication password-policy
OcNOS(config)# no aaa local authentication password-policy uppercase-count
OcNOS(config)# commit
OcNOS#show aaa authentication password-policy
```

Stronger User Password Hashes

Overview

Passwords entered during user creation are initially in plain text but must never be stored as such due to security concerns. OcNOS addresses this by using hashing algorithms to convert plain-text passwords into hashed versions before storing them in the database. Once hashed, recovering the original password becomes virtually impossible.

Feature Characteristics

This feature updates the default behavior of OcNOS when generating user password hashes. Previously, the MD5 algorithm served as the default hashing mechanism. OcNOS now uses the more secure SHA-512 algorithm as the default hash generator.

A new CLI command has been introduced to enable users to select the desired hashing algorithm for password encryption. The available options include:

- MD5
- SHA-256
- SHA-512

Key Considerations

- The selected hashing algorithm applies only to newly created usernames. Existing usernames retain the hash algorithm used at the time of creation.
- Passwords for previously configured usernames remain encrypted with their original hash algorithm.

Benefits

While MD5 has been widely used for hashing passwords in Linux-based systems, it has notable vulnerabilities:

- Collision Attacks: Different inputs can generate the same hash.
- Preimage Attacks: The original input can potentially be deduced from the hash.

With advancements in computational power, these vulnerabilities make MD5 unsuitable for modern systems. SHA-512, being a part of the SHA-2 family, offers significantly stronger cryptographic security, making it the preferred choice for password hashing.

Configuration

This steps provides a standardized approach to configuring sha-512 on OcNOS routers.

Topology

The topology represents a network device running OCNOS, with sha-512 password encryption implemented for secure communication and authentication.



Figure 19. SHA-512 Password Encryption Topology

The steps include enabling password encryption:

1. Enter Configuration Mode

```
# configure terminal
```

2. Configure the password user encryption.

```
(config)# user password encryption default sha-256
(config)# commit
(config)# exit
```



Note: By default, SHA-512 with MD5 is enabled.

3. Create a new user with password:

```
#configure terminal
(config)# username test2 password test1234
(config)#commit
(config)#exit
```

Configuration Snapshot:

```
!
user password encryption default sha-256
username test2 password encrypted $5$dV7Df2V1$yaAyIm7g8HE2mfKuB1J2LdHYuNLg8KnP6vJw98W6tQ7
username test3 password encrypted
$6$nVoAfXI0$lsZI4H3M09B3I.fREbBMLPWTdfAzzEXCua5TcoaemaSHJt2hctR01.fJy3PyCS3utW6fGYbc8ZB1NQ3cC7.d1m1
!
```

Validation

To verify the hash algorithm used for passwords, use the **show running-config** and **show user password encryption** commands.

```
ocnos#sh running-config user-management
user password encryption default sha-256
username test2 password encrypted
$5$dV7Df2V1$yaAyIm7g8HE2mfKuB1J2LdHYuNLg8KnP6vJw98W6tQ7
```

The prefix \$6\$ indicates SHA-512.



Note: If \$1\$ indicates md5, or \$5\$ indicate SHA-256.

```
ocnos#show user password encryption
```

Implementation Examples

To create a new username with a MD5 hashing algorithm, use the following commands. Once committed, the password is hashed and stored securely:

```
OcNOS(config)#username admin password test1234
OcNOS(config)#commit
```

CLI Commands

Password encryption feature introduces the following configuration commands:

- `user password encryption default`
- `show user password encryption`

user password encryption default

Use this command to configure the hash algorithm for encrypting user passwords. Changes apply only to new usernames.

Use the `no` form of this command to disable the hash algorithm for encrypting user passwords.

Command Syntax

```
user password encryption default (md5|sha-256|sha-512)
no user password encryption default (md5|sha-256|sha-512)
```

Parameters

md5

Sets MD5 as the hash algorithm.

sha-256

Sets sha-256 as the hash algorithm.

sha-sha-512

Sets SHA-512 as the hash algorithm.

Default

SHA-512

Command Mode

Configure mode

Applicability

This command was introduced before OcNOS version 6.6.0.

Examples

To configure SHA-256 as the default algorithm:

```
OcNOS(config)#user password encryption default sha-256
OcNOS(config)#commit
```

To remove SHA-256 as the default algorithm:

```
OcNOS(config)#no user password encryption default
OcNOS(config)#commit
```

show user password encryption

Use this command to display the currently configured hash algorithm.

Command Syntax

```
show user password encryption
```

Parameters

None

Default

SHA-512

Command Mode

Configure mode

Applicability

This command was introduced before OcNOS version 6.6.0.

Examples

To show password encryption:

```
OcNOS#show user password encryption
Username password hash algorithm: sha-512
OcNOS#
```

| USER MANAGEMENT COMMAND REFERENCE

User Management	346
clear aaa local user lockout username	347
debug user-mgmt	348
show user-account	349
username	350

User Management

This chapter is a reference for user management commands.

This chapter includes these commands:

clear aaa local user lockout username	347
debug user-mgmt	348
show user-account	349
username	350

clear aaa local user lockout username

Use this command to unlock the locked user due to three times wrong password login attempt.

Command Syntax

```
clear aaa local user lockout username USERNAME
```

Parameters

USERNAME

User name; length 2-15 characters

Command Mode

Execution mode

Applicability

This command was introduced before OcNOS version 1.3.

Example

```
#clear aaa local user lockout username testuser
```

debug user-mgmt

Use this command to display user management debugging information.

Use the `no` form of this command stop displaying user management debugging information.

Command Syntax

```
debug user-mgmt
no debug user-mgmt
```

Parameters

None

Default

None

Command Mode

Execution mode and Configure mode

Applicability

This command was introduced before OcNOS version 1.3.

Example

```
#debug user-mgmt

#config t
(config)#debug user-mgmt
```

show user-account

Use this command to display information about all users or a given user.

Command Syntax

```
show user-account (WORD|)
```

Parameters

WORD

User name

Command Mode

Privileged execution mode

Applicability

This command was introduced before OcNOS version 1.3.

Example

```
#show user-account
User:user1
roles: network-operator
User:user2
roles: network-operator
User:user3
roles: network-operator
```

username

Use this command to add a user or to change a user password.

The `role` parameter maps to privilege levels in the **TACACS**¹ server as shown in the table below.

Table 20. Role/privilege level mapping

Role	Privilege level
Network administrator	15
Network engineer	14
Network operator	1 to 13
Network user	0 or greater than 15

Use the `no` form of this command to remove a user.

Command Syntax

```
username USERNAME
username USERNAME password (encrypted) PASSWORD
username USERNAME role (network-admin|network-engineer|network-operator|network-user)
username USERNAME role (network-admin|network-engineer|network-operator|network-user) password
(encrypted) PASSWORD
username disable-default
no username disable-default
no username USERNAME
```

Parameters

USERNAME

User name; length 2-15 characters

encrypted

Encrypted password

PASSWORD

Password; length: 8-32 characters. Password must contain at least:

- One uppercase letter
- One lowercase letter
- One digit
- One special character (acceptable special characters: ~`!@#%&*(){}'[],.\"</>+_-;:),



Note: The following characters are not acceptable in passwords: '=?|>

network-admin

Network administrator role with all access permissions that can make permanent changes to the configuration. Changes persist after a reset/reboot of the switch.

¹Terminal Access Controller Access Control System

Only network administrators can manage other users with the [enable password](#), [Authentication, Authorization and Accounting](#) (page 193), [RADIUS¹ Commands](#), and [TACACS+ Commands](#).

network-engineer

Network engineer role with all access permission that can make permanent changes to the configuration. Changes persist after a reset/reboot of the switch.

network-operator

Network operator role with all access permissions that can make temporary changes to the configuration. Changes do not persist after a reset/reboot of the switch.

network-user

Network user role with access permissions to display the configuration, but cannot change the configuration.

disable-default

This option is used to disable the implicit configuration of default user by the system. This command can be executed only by users with “**network-admin**” privileges. When this option is configured, explicit configuration of default user will be rejected. If default-user is explicitly configured using “**username**” CLI, it should be removed using “**no username USERNAME**” before configuring “disable-default”.

Default

None

Command Mode

Configure mode

Applicability

This command was introduced before OcNOS version 1.3.

Example

```
#configure terminal
(config)#username fred_smith password Fred123$
```

¹Remote Authentication Dial-In User Service

DHCP CONFIGURATION

DHCP Client Configuration	353
Overview	353
DHCP Client Configuration for IPv4	353
DHCP Client Configuration for IPv6	354
DHCP Server Configuration	357
Overview	357
DHCP Server Configuration for IPv4	357
DHCP Server Configuration for IPv6	358
DHCP Server Group	362
Overview	362
Feature Characteristics	363
Benefits	363
Configuration	363
New CLI Commands	375
DHCP Relay Agent Configuration	383
Overview	383
DHCP Relay for IPv4	383
DHCP Relay for IPv6 Configuration	384
DHCP Relay option 82	385
Physical Interface Configuration with non-default VRF	388
DHCP-Relay with different VRFs	392
DHCP Relay for IPv6 Configuration with different VRFs	394
DHCPv6 Prefix Delegation Configuration	396
Overview	396
Benefits	396
Configuration	396
DHCPv6 Relay Prefix Delegation Route Injection Configuration	403
Overview	403

DHCP Client Configuration

Overview

Dynamic Host Configuration Protocol (**DHCP**¹) protocol is used for assigning dynamic IP addresses to systems on a network. Dynamic addressing allows a system to have an IP address each time it connects to the network. DHCP makes network administration easier by removing the need to manually assign a unique IP address every time a new system is added to the network. It is especially useful to manage mobile users. Once a system is configured to use DHCP, it can be automatically configured on any network that has a DHCP server.

DHCP uses a client-server model, in which the DHCP server centrally manages the IP addresses used in the network. DHCP clients obtain an IP address on lease from the DHCP server.

DHCP Client Configuration for IPv4

Before configuring the DHCP in client, make sure that DHCP server is ready and also dhcpd is running on the server machine.

Figure 20. DHCP sample topology

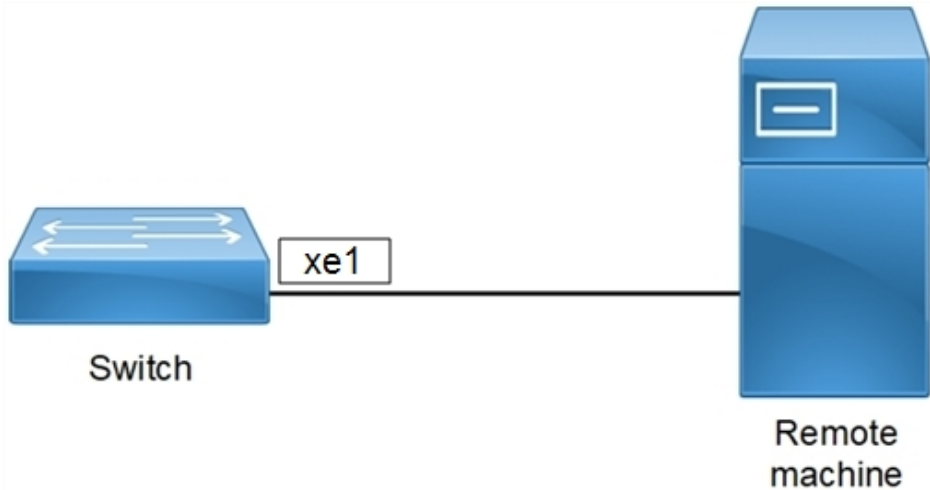

#configure terminal	Enter Configure mode.
(config)#feature dhcp	Enable the feature dhcp. This will be enabled by default.
(config)#interface xe1	Specify the interface(xe1) to be configured and enter the interface mode.
(config-if)#ip address dhcp	The client requests for the IP address to the server, once it receives the acknowledgment from the server, it

¹Dynamic Host Configuration Protocol

	assigns the IP address to the interface in which this command is enabled.
<code>(config if)#exit</code>	Exit interface mode.
<code>(config)#commit</code>	Commit the candidate configuration to the running configuration.
<code>(config)#interface eth0</code>	Enter management interface mode.
<code>(config-if)#ip address dhcp</code>	The client requests for the IP address to the server, once it receives the Acknowledgment from the server, it assigns the IP address to the management interface.
<code>(config if)#exit</code>	Exit interface mode.
<code>(config)#commit</code>	Commit the candidate configuration to the running configuration.

Validation Commands

```
#show running-config dhcp
interface xe1
 ip address dhcp
 !
 ip dhcp relay information option

#sh ip interface brief
```

Interface	IP-Address	Admin-Status	Link-Status	GMPLS Type
eth0	10.12.44.20	up	up	-
lo	127.0.0.1	up	up	-
lo.4	127.0.0.1	up	up	-
vlan1.1	unassigned	up	down	-
xe1/1	2.2.2.3	up	up	-
xe1/2	unassigned	down	down	-
xe1/3	unassigned	down	down	-
xe1/4	unassigned	up	down	-
xe2	*40.40.40.40	up	down	-
xe3/1	20.20.30.1	up	up	-

DHCP Client Configuration for IPv6

Before configuring the DHCP in client, make sure that DHCP server is ready and also dhcpd is running on the server machine.

Figure 21. DHCP sample topology

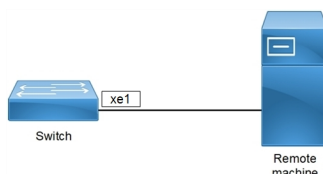

<code>#configure terminal</code>	Enter Configure mode.
<code>(config)#feature dhcp</code>	Enable the feature dhcp. This will be enabled by default.

<code>(config)#interface xe1</code>	Specify the interface(xe1) to be configured and enter the interface mode.
<code>(config-if)#ipv6 dhcp client request dns-nameserver</code>	The client request for name-server configured in server
<code>(config-if)#ipv6 dhcp client request domain-search</code>	The client request for domain names with ip
<code>(config-if)#ipv6 dhcp client request ntp-server</code>	The client request for Ntp server details configured in server
<code>(config-if)#ipv6 dhcp client request rapid-commit</code>	Enables rapid commit option
<code>(config-if)#ipv6 dhcp client request vendor-specific-information</code>	The client request for vendor specific information
<code>(config-if)#ipv6 dhcp client duid llt</code>	Set duid type for DHCP Client. Possible values are ll or ll
<code>(config-if)#ipv6 dhcp client dad-wait-time 300</code>	Max time that the client process should wait for the duplicate address detection to complete before initiating DHCP requests. Values range from 1 - 600
<code>(config-if)#ipv6 address dhcp</code>	The client requests for the IP address to the server, once it receives the acknowledgment from the server, it assigns the IP address to the interface in which this command is enabled.
<code>(config if)#exit</code>	Exit interface mode.
<code>(config)#commit</code>	Commit the candidate configuration to the running configuration.
<code>(config)#interface eth0</code>	Enter management interface mode.
<code>(config-if)#ip address dhcp</code>	The client requests for the IP address to the server, once it receives the Acknowledgement from the server, it assigns the IP address to the management interface.
<code>(config if)#exit</code>	Exit interface mode.
<code>(config)#commit</code>	Commit the candidate configuration to the running configuration

Validation Commands

```
OcNOS#show ipv6 interface brief
Interface          IPv6-Address          Admin-Sta
tus
ce20               fe80::eac5:7aff:fe28:a67b  [up/up]
ce21               fe80::eac5:7aff:fe28:a67c  [up/down]
eth0               fe80::eac5:7aff:fe8e:c365   [up/up]
xe1                *3001::1
                  fe80::eac5:7aff:fe28:a66b   [up/up]

OcNOS#show ipv6 dhcp vendor-opts
Interface name     vendor-opts
```

```
=====
xe1                0:0:9:bf:0:1:0:c:48:65:6c:6c:6f:20:77:6f:72:6c:64:21
```

```
OcNOS#show running-config dhcp
interface eth0
 ip address dhcp
!
interface xe1
 ipv6 dhcp client request dns-nameserver
 ipv6 dhcp client request domain-search
 ipv6 dhcp client request ntp-server
 ipv6 dhcp client request rapid-commit
 ipv6 dhcp client request vendor-specific-information
 ipv6 dhcp client duid llc
 ipv6 dhcp client dad-wait-time 300
 ipv6 address dhcp
!
!
```

DHCP Server Configuration

Overview

A DHCP¹ Server is a network server that automatically provides and assigns IP addresses, default gateways and other network parameters to client devices. It relies on the standard protocol known as Dynamic Host Configuration Protocol or DHCP to respond to broadcast queries by clients.

DHCP Server Configuration for IPv4

Before configuring make sure that DHCP server is ready.

Topology

Figure 22. DHCP IPv4 topology



Configuration

DHCP IPv4 Client Interface

#configure terminal	Enter Configure mode.
(config)#interface xe1	Specify the interface (xe1) to be configured and enter the interface mode.
(config-if)#ip address dhcp	The client requests for the IP address to the server, once it receives the acknowledgment from the server, it assigns the IP address to the interface in which this command is enabled.
(config-if)#ip dhcp client request dns-nameserver	The client requests for the DNS name server.
(config-if)#ip dhcp client request ntp-server	The client requests for the NTP server .
(config-if)#ip dhcp client request host-name	The client requests for the Name of the client.
(config-if)#ip dhcp client request log-server	The client requests for the log server.
(config if)#exit	Exit interface mode.

¹Dynamic Host Configuration Protocol

DHCP IPv4 Server Interface

#configure terminal	Enter Configure mode.
(config)#interface xe2	Specify the interface (xe2) to be configured and enter the interface mode.
(config-if)#ip address 10.10.10.1/24	Configure the IP address to the server interface.
(config-if)#ip address dhcp	The client requests for the IP address to the server, once it receives the acknowledgment from the server, it assigns the IP address to the interface in which this command is enabled.
(config if)#exit	Exit interface mode.
(config)#commit	Commit the candidate configuration to the running configuration.

DHCP IPv4 Server Feature

#configure terminal	Enter Configure mode.
(config)#ip vrf vrf1	Configure IP VRF ¹ name.
(config-vrf)#ip dhcp server max-lease-time 100	Configure max lease time.
(config-vrf)#ip dhcp server default-lease-time 100	Configure default lease time.
(config-vrf)#ip dhcp server pool test	Configure DHCP server pool name.
(dhcp-config)#network 3.3.3.0 netmask 255.255.255.0	Configure network and netmask.
(dhcp-config)#address range low-address 3.3.3.1 high-address 3.3.3.4	Configure address IPv4 range.
(dhcp-config)#routers 3.3.3.1	IPv4 DHCP Server option to provide router details to a DHCP client ² .
(dhcp-config)#boot-file test	Configure boot-file name.
(dhcp-config)#host-name dhcp-server	Configure host name.
(dhcp-config)#ntp-server 4.4.4.5	Configure NTP server.
(dhcp-config)#log-server 5.5.5.6	Configure log server.
(dhcp-config)#dns-server 5.5.5.5	Configure DNS server.
(dhcp-config)#tftp-server 5.5.5.6	Configure TFTP server.
(dhcp-config)#boot-file test	Configure boot-file name.

DHCP Server Configuration for IPv6

Before configuring make sure that DHCP server is ready.

¹Virtual Routing and Forwarding

²A DHCP client is a hardware device or software that uses DHCP to get the network configuration information from a DHCP Server. VRF: VRF creates a logically isolated routing table within a single physical network device. Each VRF instance works as an independent routing instance that enables separate network traffic, maintains different routing tables, and provides network isolation.

Topology

Figure 23. DHCP IPv6 topology



Configuration

DHCP IPv6 Client Interface

<code>#configure terminal</code>	Enter Configure mode.
<code>(config)#interface xe47</code>	Specify the interface (xe47) to be configured and enter the interface mode.
<code>(config-if)#ipv6 address dhcp</code>	The client requests for the IPv6 address to the server, once it receives the acknowledgment from the server, it assigns the IP address to the interface in which this command is enabled.
<code>(config-if)#ipv6 dhcp client request dns-nameserver</code>	The client requests for the DNS name server.
<code>(config-if)#ipv6 dhcp client request ntp-server</code>	The client requests for the NTP server.
<code>(config-if)#ipv6 dhcp client request domain-search</code>	The client request for IPv6 domain search.
<code>(config-if)#ipv6 dhcp client request vendor-specific-information</code>	The client request for IPv6 vendor-specific-information.
<code>(config-if)#ipv6 dhcp client request rapid-commit</code>	The client request to enable rapid-commit.
<code>(config if)#exit</code>	Exit interface mode.
<code>(config)#commit</code>	Commit the candidate configuration to the running configuration.

DHCP IPv6 Server Interface

<code>#configure terminal</code>	Enter Configure mode.
<code>(config)#interface xe2</code>	Specify the interface (xe2) to be configured and enter the interface mode.
<code>(config-if)#ipv6 address dhcp</code>	The client requests for the IPv6 address to the server, once it receives the acknowledgment from the server, it assigns the IP address to the interface in which this command is enabled.
<code>(config-if)#ipv6 address 2001::1/64</code>	Configure the IPv6 address to the server interface.
<code>(config if)#ipv6 dhcp server</code>	Configure an interface as a DHCP server starting

	interface.
(config if)#exit	Exit interface mode.
(config)#commit	Commit the candidate configuration to the running configuration.

DHCP IPv6 Server Feature

#configure terminal	Enter Configure mode
(config)#ip vrf vrf1	Configure IP VRF name
(config-vrf)#ipv6 dhcp server preference	Configure IPv6 DHCP server preference
(config-vrf)#ipv6 dhcp server rapid-commit	Configure IPv6 DHCP server rapid-commit
(config-vrf)#ipv6 dhcp server pool test	Configure IPv6 DHCP server pool name
(dhcp6-config)#network 2001:: netmask 64	Configure IPv6 network and netmask
(dhcp6-config)#address range low-address 2001::1 high-address 2001::124	Configure IPv6 address range
(dhcp6-config)#vendor-options 00:00:09:bf:63	Configure IPv6 vendor option
(dhcp6-config)#ntp-server 4001::1	Configure IPv6 NTP server
(dhcp6-config)#dns-server 3001::1	Configure IPv6 DNS server
(dhcp6-config)#log-server 5.5.5.6	Configure log server
(dhcp6-config)#domain-name abcd	Configure domain name
(dhcp6-config)#tftp-server 5.5.5.6	Configure TFTP server
(dhcp6-config)#boot-file test	Configure boot-file name

Validation

Client

```
OcNOS#sh running-config dhcp
interface eth0
  ip address dhcp
!
interface xe2
  ipv6 dhcp client request dns-nameserver
  ipv6 dhcp client request domain-search
  ipv6 dhcp client request ntp-server
  ipv6 dhcp client request rapid-commit
  ipv6 dhcp client request vendor-specific-information
  ipv6 address dhcp
!

OcNOS#show ipv6 int br
Interface          IPv6-Address          Admin-Sta
tus
ce49                unassigned            [up/down]

eth0                fe80::e69d:73ff:fe05:8100 [up/up]

lo                  ::1                    [up/up]

lo.management       ::1                    [up/up]
```

xe45	unassigned	[up/down]
xe46	unassigned	[up/down]
xe47	*2001::124 fe80::e69d:73ff:fe84:8137	[up/up]
xe48	unassigned	[up/down]

Server

```
OcNOS#show running-config dhcp
interface eth0
  ip address dhcp
  !
  !

ipv6 dhcp server rapid-commit
ipv6 dhcp server preference
ipv6 dhcp server pool test
  network 2001:: netmask 64
  address range low-address 2001::1 high-address 2001::124
  vendor-options 00:00:09:bf:63
  ntp-server 4001::1
  dns-server 3001::1
  domain-name abcd
interface xe2
  ipv6 dhcp server
  !
```

DHCP Server Group

Overview

Dynamic Host Control Protocol (**DHCP**¹) Group provides the capability to specify multiple DHCP servers as a group on the **DHCP relay agent**² and to correlate a relay agent interface with the server group. When the interface receives request messages from clients, the relay agent forwards the message to all the DHCP servers of the group. One or multiple DHCP servers in the group process the request and respond with an offer to the client. The client reviews the offer and sends the request message to the chosen server to obtain the network configuration that includes an IP address. The illustration below shows a **DHCP client**³ sending a request message to a DHCP relay agent that forwards the message to the three servers in the DHCP server group to get their network configuration. The DHCP client and DHCP relay agent run OcNOS, but the DHCP servers can be OcNOS or Linux devices.

Figure 2-1: DHCP server group

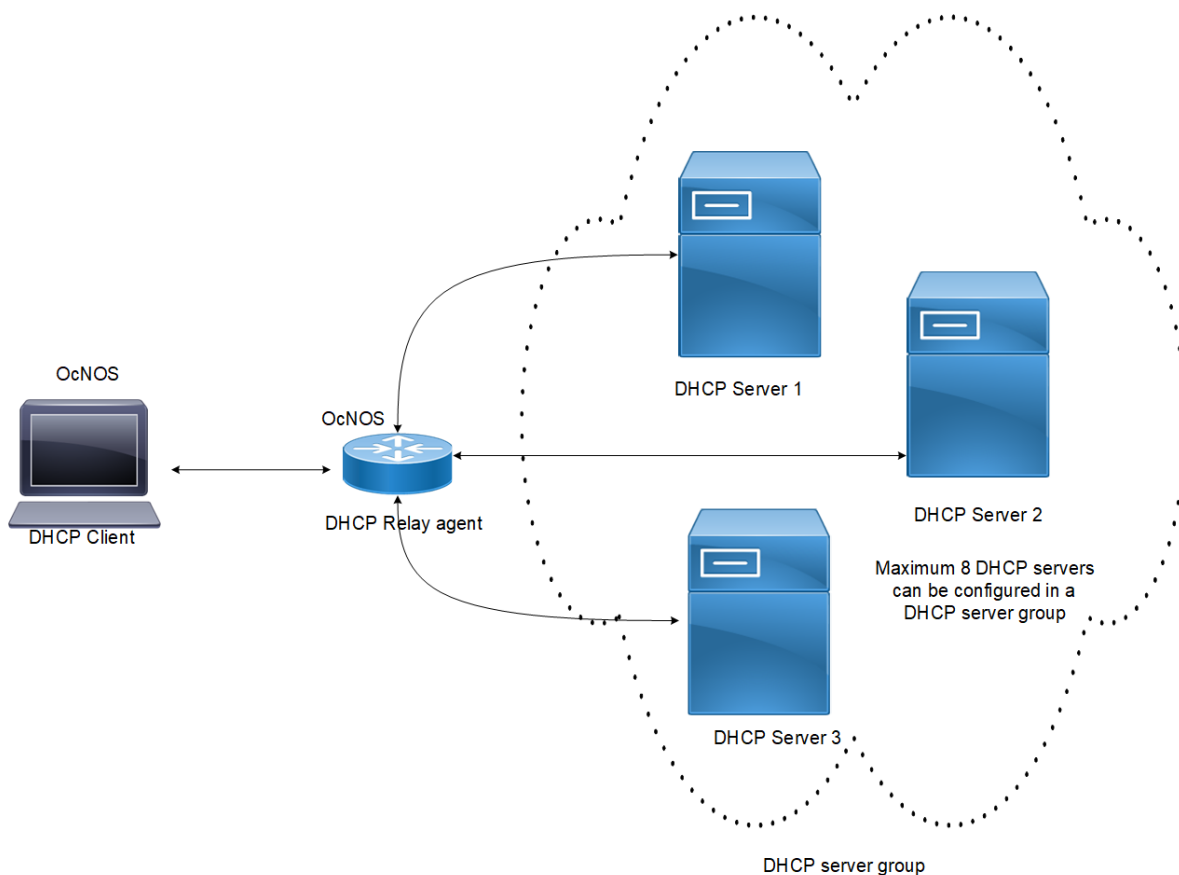

¹Dynamic Host Configuration Protocol

²A DHCP relay forwards the request from a DHCP client to the DHCP server group and takes the response from the DHCP server group to the DHCP client.

³A DHCP client is a hardware device or software that uses DHCP to get the network configuration information from a DHCP Server. VRF: VRF creates a logically isolated routing table within a single physical network device. Each VRF instance works as an independent routing instance that enables separate network traffic, maintains different routing tables, and provides network isolation.

Feature Characteristics

This feature enables the configuration of the DHCP server group and attaches it to a DHCP relay agent through the CLI and the NetConf interface. A DHCP server group can be attached with multiple DHCP relay uplink interfaces, but at a given time, a single DHCP relay uplink interface is allowed to be attached with a single DHCP server group. The attachment of the DHCP relay uplink interface to another DHCP server group dissociates its attachment with the earlier attached DHCP server group.

This feature helps to configure DHCP IPv4 and IPv6 groups and attach server IP addresses to the group. Creating a maximum of 32 IPv4 and 32 IPv6 groups per **VRF**¹ is allowed, and configuring 8 DHCP servers is permitted for each DHCP server group.

Benefits

The DHCP relay agent forwards the request message from the DHCP client to multiple DHCP servers in the group. Forwarding the request message to multiple DHCP servers increases the reliability of obtaining the network configuration.

Configuration

Before configuring the **DHCP client**² and the **DHCP relay agent**³, make sure that **DHCP**⁴ server is configured and the `dhcpd` service is running in the DHCP server.

Topology

In the below example, DHCP server1 and DHCP server2 (OcNOS or Linux devices) are connected to the DHCP relay agent (an OcNOS device), and the DHCP relay is connected to a DHCP client (an OcNOS device). The DHCP client sends discover message to the DHCP servers through the DHCP relay agent.

¹Virtual Routing and Forwarding

²A DHCP client is a hardware device or software that uses DHCP to get the network configuration information from a DHCP Server. VRF: VRF creates a logically isolated routing table within a single physical network device. Each VRF instance works as an independent routing instance that enables separate network traffic, maintains different routing tables, and provides network isolation.

³A DHCP relay forwards the request from a DHCP client to the DHCP server group and takes the response from the DHCP server group to the DHCP client.

⁴Dynamic Host Configuration Protocol

Figure 2-1: DHCP server group topology

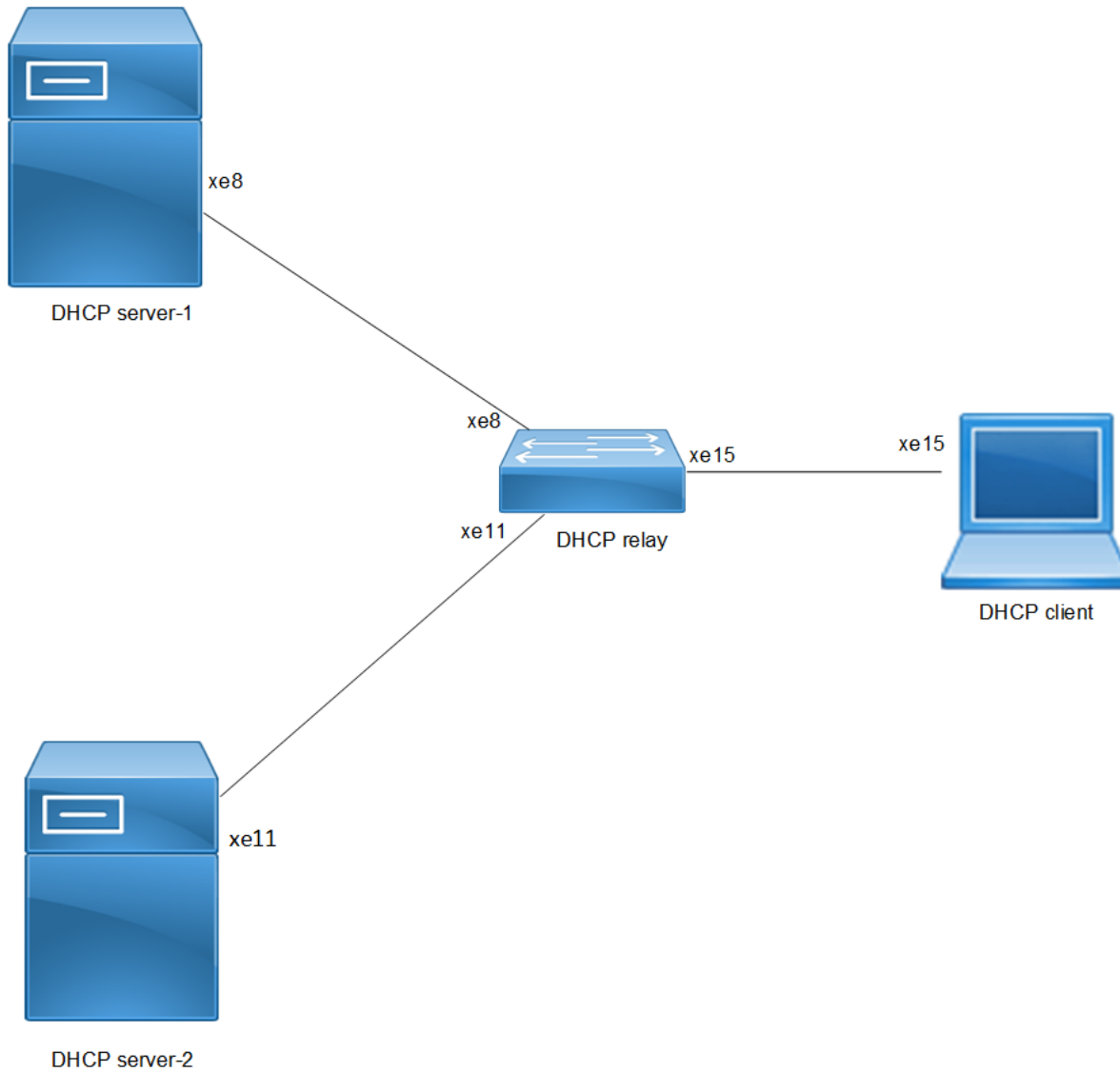

DHCP Server-1 Configuration for IPv4

This section shows how to configure the DHCPv4 Server-1.

DHCPv4 Server-1

OcNOS#configure terminal	Enter configure mode.
OcNOS(config)#ip dhcp server pool DHCP ¹ -Server-1	Configure DHCP server group for server in global mode.
OcNOS(dhcp-config)#network 10.10.10.0 netmask 255.255.255.0	Configure network 10 . 10 . 10 . 0 and netmask 255 . 255 . 255 . 0 .
OcNOS(dhcp-config)#address range low-address	Configure address range from 10 . 10 . 10 . 1 to

¹Dynamic Host Configuration Protocol

10.10.10.1 high-address 10.10.10.254	10 . 10 . 10 . 254 .
OcNOS (dhcp-config) #dns-server 192.2.2.2	Configure the DNS server 192 . 2 . 2 . 2 .
OcNOS (dhcp-config) #commit	Commit the candidate configuration to the running configuration.
OcNOS (dhcp-config) #exit	Exit DHCP config mode.
OcNOS (config) #ip dhcp server pool DHCP-SER	Configure DHCP server group for client in global mode.
OcNOS (dhcp-config) #network 20.20.20.0 netmask 255.255.255.0	Configure network 20 . 20 . 20 . 0 and netmask 255 . 255 . 255 . 0 .
OcNOS (dhcp-config) #address range low-address 20.20.20.1 high-address 20.20.20.30	Configure address range from 20 . 20 . 20 . 1 to 20 . 20 . 20 . 30 .
OcNOS (dhcp-config) #commit	Commit the candidate configuration to the running configuration.
OcNOS (dhcp-config) #exit	Exit dhcp config mode.
OcNOS (config) #interface xe8	Enter interface mode xe8 .
OcNOS (config-if) #ip address 10.10.10.2/24	Configure IP address on the interface xe8 .
OcNOS (config-if) #ip dhcp server	Server should be configured on the interface while connected to the relay.
OcNOS (config-if) #commit	Commit the candidate configuration to the running configuration.
OcNOS (config-if) #exit	Exit interface mode.
OcNOS (config) #ip route 20.20.20.0/24 10.10.10.3	Configure static route of 20 . 20 . 20 . 0/24 by next hop interface 10 . 10 . 10 . 3 .
OcNOS (config) #commit	Commit the candidate configuration to the running configuration.
OcNOS (config) #exit	Exit config mode.

Validation

The below shows the running configuration of the DHCPv4 Server-1 node:

```
OcNOS#show running-config dhcp
interface eth0
 ip address dhcp
 !
 !

ip dhcp server pool DHCP-Server-1
 network 10.10.10.0 netmask 255.255.255.0
 address range low-address 10.10.10.1 high-address 10.10.10.254
 dns-server 192.2.2.2
ip dhcp server pool DHCP-SER
 network 20.20.20.0 netmask 255.255.255.0
 address range low-address 20.20.20.1 high-address 20.20.20.30
interface xe8
 ip dhcp server
 !
OcNOS#
```

DHCP Server-2 Configuration for IPv4

This section shows how to configure the DHCPv4 Server-2.

DHCPv4 Server-2

OcNOS#configure terminal	Enter configure mode.
OcNOS(config)#ip dhcp server pool DHCP¹-Server-2	Configure DHCP server group for server in global mode.
OcNOS(dhcp-config)#network 40.10.10.0 netmask 255.255.255.0	Configure network 40.10.10.0 and netmask 255.255.255.0 .
OcNOS(dhcp-config)#address range low-address 40.10.10.1 high-address 40.10.10.254	Configure address range from 40.10.10.1 to 40.10.10.254 .
OcNOS(dhcp-config)#dns-server 192.2.2.2	Configure DNS server 192.2.2.2 .
OcNOS(dhcp-config)#ip dhcp server pool DHCP-SER	Configure DHCP server group for client in global mode.
OcNOS(dhcp-config)#network 20.20.20.0 netmask 255.255.255.0	Configure network 20.20.20.0 and netmask 255.255.255.0 .
OcNOS(dhcp-config)#address range low-address 20.20.20.1 high-address 20.20.20.30	Configure address range from 20.20.20.1 to 20.20.20.30 .
OcNOS(dhcp-config)#commit	Commit the candidate configuration to the running configuration.
OcNOS(dhcp-config)#exit	Exit DHCPv6 config mode.
OcNOS(config)#interface xe11	Enter interface mode xe11 .
OcNOS(config-if)#ip address 40.10.10.2/24	Configure IP address 40.10.10.2/24 on the interface xe11 .
OcNOS(config-if)#ip dhcp server	Server should be configured on the interface while connected to the relay.
OcNOS(config-if)#commit	Commit the candidate configuration to the running configuration.
OcNOS(config-if)#exit	Exit interface mode.
OcNOS(config)#ip route 20.20.20.0/24 40.10.10.3	Configure static route 20.20.20.0/24 by next hop interface 40.10.10.3 .
OcNOS(config)#commit	Commit the candidate configuration to the running configuration.
OcNOS(config)#exit	Exit config mode.

Validation

The below shows the running configuration of the DHCPv4 Server-2 node:

```
OcNOS#show running-config dhcp
interface eth0
```

¹Dynamic Host Configuration Protocol

```

ip address dhcp
!
!

ip dhcp server pool DHCP-Server-2
network 40.10.10.0 netmask 255.255.255.0
address range low-address 40.10.10.1 high-address 40.10.10.254
dns-server 192.2.2.2
ip dhcp server pool DHCP-SER
network 20.20.20.0 netmask 255.255.255.0
address range low-address 20.20.20.1 high-address 20.20.20.30
interface xe11
ip dhcp server
!
OcNOS#

```

DHCP Relay Agent Configuration for IPv4

This section shows how to configure the DHCPv4 relay agent.

DHCPv4 Relay Agent

OcNOS#configure terminal	Enter configure mode.
OcNOS(config)#ip dhcp relay server-group dhcp-relay-gp	Configure relay server-group group name in global mode.
OcNOS(dhcp-relay-group)#server 10.10.10.2	Configure server 10 . 10 . 10 . 2.
OcNOS(dhcp-relay-group)#exit	Exit DHCP ¹ relay group.
OcNOS(config)#interface xe15	Enter interface mode xe15 .
OcNOS(config-if)#ip address 20.20.20.2/24	Configure IPv4 address 20 . 20 . 20 . 2 on the interface xe15 .
OcNOS(config-if)#ip dhcp relay	Relay should be configured on the interface connecting to the client.
OcNOS(config-if)#commit	Commit the candidate configuration to the running configuration.
OcNOS(config-if)#exit	Exit interface mode.
OcNOS(config)#interface xe8	Enter interface mode xe8 .
OcNOS(config-if)#ip address 10.10.10.3/24	Configure IPv4 address 10 . 10 . 10 . 3 on the interface xe8 .
OcNOS(config-if)#ip dhcp relay uplink	Configure relay uplink on the device connecting the server.
OcNOS(config-if)#ip dhcp relay server-select dhcp-relay-gp	Configure relay server-select group name on the device connected to the server.
OcNOS(config-if)#commit	Commit the candidate configuration to the running configuration.
OcNOS(config-if)#exit	Exit interface mode.
OcNOS(config)#ip dhcp relay server-group dhcp-	Configure relay server-group group name in global

¹Dynamic Host Configuration Protocol

relay-gp	mode.
OcNOS (dhcp-relay-group) #server 40.10.10.2	Configure IPv4 DHCP server address 40.10.10.2 on the server group.
OcNOS (dhcp-relay-group) #commit	Commit the candidate configuration to the running configuration.
OcNOS (dhcp-relay-group) #exit	Exit DHCP relay group.
OcNOS (config) #interface xe11	Enter interface mode xe11 .
OcNOS (config-if) #ip address 40.10.10.3/24	Configure IPv4 address 40.10.10.3 on the interface xe11 .
OcNOS (config-if) #ip dhcp relay uplink	Configure relay uplink on the device connecting the server.
OcNOS (config-if) #ip dhcp relay server-select dhcp-relay-gp	Configure relay server-select group name on the device connected to the server.
OcNOS (config-if) #commit	Commit the candidate configuration to the running configuration.
OcNOS (config-if) #exit	Exit interface mode.

Validation

The below shows the running configuration of the DHCPv4 relay agent node:

```
OcNOS#show running-config dhcp
interface eth0
 ip address dhcp
!
!

ip dhcp relay server-group dhcp-relay-gp
 server 10.10.10.2
 server 40.10.10.2
interface xe8
 ip dhcp relay uplink
 ip dhcp relay server-select dhcp-relay-gp
!
interface xe11
 ip dhcp relay uplink
 ip dhcp relay server-select dhcp-relay-gp
!
interface xe15
 ip dhcp relay
!
OcNOS#
OcNOS#
OcNOS#show ip dhcp relay
DHCP relay service is Enabled.
VRF Name: default
Option 82: Disabled
Interface                Uplink/Downlink
-----                -
xe8                      Uplink
xe11                     Uplink
xe15                     Downlink
Interface                Group-Name          Server
-----                -
xe11                     dhcp-relay-gp      10.10.10.2,40.10.10.2
Incoming DHCPv4 packets which already contain relay agent option are FORWARDED unchanged.
OcNOS#
```

DHCP Client Configuration for IPv4

This section shows how to configure the DHCPv4 Client.

DHCPv4 Client

OcNOS#configure terminal	Enter configure mode.
OcNOS (config)#feature dhcp	Enable the feature DHCP ¹ . This will be enabled by default.
OcNOS (config)#int xe15	Enter interface mode xe15 .
OcNOS (config-if)#ip address dhcp	The client requests for the IP address to the server, once it receives the acknowledgment from the server, it assigns the IP address to the interface in which this command is enabled.
OcNOS (config-if)#commit	Commit the candidate configuration to the running configuration.
OcNOS (config-if)#exit	Exit interface mode.

Validation

The below shows the running configuration of the DHCPv4 client node:

```
OcNOS#show running-config dhcp
interface eth0
  ip address dhcp
!
interface xe15
  ip address dhcp

OcNOS#show ip interface brief

'*' - address is assigned by dhcp client

Interface          IP-Address      Admin-Status    Link-Status
cd1                 unassigned     up               down
cd3                 unassigned     up               down
ce0                 unassigned     up               down
ce2                 unassigned     up               down
eth0                *10.12.121.156 up               up
lo                  127.0.0.1      up               up
lo.management      127.0.0.1      up               up
xe4                 unassigned     up               down
xe5                 unassigned     up               down
xe6                 unassigned     up               down
xe7                 unassigned     up               down
xe8                 unassigned     up               down
xe9                 unassigned     up               down
xe10                unassigned     up               down
xe11                unassigned     up               down
xe12                unassigned     up               down
xe13                unassigned     up               down
xe14                unassigned     up               down
xe15                *20.20.20.1    up               up
xe16                unassigned     up               down
xe17                unassigned     up               down
xe18                unassigned     up               down
```

¹Dynamic Host Configuration Protocol

```

xe19          unassigned    up          down
xe20          unassigned    up          down
xe21          unassigned    up          down
xe22          unassigned    up          down
xe23          unassigned    up          down
xe24          unassigned    up          down
xe25          unassigned    up          down
xe26          unassigned    up          down
xe27          unassigned    up          down
OcnOS#--
OcnOS#
OcnOS#show ip int xe15 br

'*' - address is assigned by dhcp client

Interface      IP-Address    Admin-Status  Link-Status
xe15           *20.20.20.1   up            up
OcnOS#

```

DHCP Server-1 Configuration for IPv6

This section shows how to configure the DHCPv6 Server-1.

DHCPv6 Server-1

OcnOS#configure terminal	Enter configure mode.
OcnOS(config)#ipv6 dhcp server pool DHCPv6-Server-1	Configure DHCP ¹ server group for server in global mode.
OcnOS(dhcp6-config)#network 2001:: netmask 64	Configure network 2001:: and netmask 64 .
OcnOS(dhcp6-config)#address range low-address 2001::1 high-address 2001::124	Configure address range from 2001::1 to 2001::124 .
OcnOS(dhcp6-config)#ipv6 dhcp server pool DHCPv6-SER	Configure DHCP server group for client in global mode.
OcnOS(dhcp6-config)#network 3001:: netmask 64	Configure network 3001:: and netmask 64 .
OcnOS(dhcp6-config)#address range low-address 3001::1 high-address 3001::124	Configure address range from 3001::1 to 3001::124 .
OcnOS(dhcp6-config)#commit	Commit the candidate configuration to the running configuration.
OcnOS(dhcp6-config)#exit	Exit DHCPv6 config mode.
OcnOS(config)#interface xe8	Enter interface mode xe8 .
OcnOS(config-if)#ipv6 address 2001::2/64	Configure IPv6 address 2001::2/64 on the interface xe8 .
OcnOS(config-if)#ipv6 dhcp server	Server should be configured on the interface while connected to the relay.
OcnOS(config-if)#commit	Commit the candidate configuration to the running configuration.
OcnOS(config-if)#exit	Exit interface mode.

¹Dynamic Host Configuration Protocol

OcNOS(config)#ipv6 route 3001::/64 2001::3	Configure static route 3001::/64 by next hop interface 2001::3 .
OcNOS(config)#commit	Commit the candidate configuration to the running configuration.
OcNOS(config)#exit	Exit config mode.

Validation

The below shows the running configuration of the DHCPv6 Server-1 node:

```
OcNOS#show running-config dhcp
interface eth0
 ip address dhcp
 !
 !

ipv6 dhcp server pool DHCPv6-Server-1
 network 2001:: netmask 64
 address range low-address 2001::1 high-address 2001::124
ipv6 dhcp server pool DHCPv6-SER
 network 3001:: netmask 64
 address range low-address 3001::1 high-address 3001::124
interface xe8
 ipv6 dhcp server
 !
 !
OcNOS#
```

DHCP Server-2 Configuration for IPv6

This section shows how to configure the DHCPv6 Server-2.

DHCPv6 Server-2

OcNOS#configure terminal	Enter configure mode.
OcNOS(config)#ipv6 dhcp server pool DHCPv6-Server-2	Configure dhcp server group for server in global mode.
OcNOS(dhcp6-config)#network 4001:: netmask 64	Configure network 4001:: and netmask 64 .
OcNOS(dhcp6-config)#address range low-address 4001::1 high-address 4001::124	Configure address range from 4001::1 to 4001::124 .
OcNOS(dhcp6-config)#ipv6 dhcp server pool DHCPv6-SER	Configure DHCP¹ server group for client in global mode.
OcNOS(dhcp6-config)#network 3001:: netmask 64	Configure network 3001:: and netmask 64 .
OcNOS(dhcp6-config)#address range low-address 3001::1 high-address 3001::124	Configure address range from 3001::1 to 3001::124 .
OcNOS(dhcp6-config)#commit	Commit the candidate configuration to the running configuration.
OcNOS(dhcp6-config)#exit	Exit DHCPv6 config mode.
OcNOS(config)#interface xe11	Enter interface mode xe11 .

¹Dynamic Host Configuration Protocol

OcNOS (config-if)#ipv6 address 4001::2/64	Configure IPv6 address on the interface xe11 .
OcNOS (config-if)#ipv6 dhcp server	Server should be configured on the interface while connected to the relay.
OcNOS (config-if)#commit	Commit the candidate configuration to the running configuration.
OcNOS (config-if)#exit	Exit interface mode.
OcNOS (config)#ipv6 route 3001::/64 4001::3	Configure static route 3001 : : /64 by next hop interface 4001 : : 3 .
OcNOS (config)#commit	Commit the candidate configuration to the running configuration.
OcNOS (config)#exit	Exit config mode.

Validation

The below shows the running configuration of the DHCPv6 Server-2 node:

```
OcNOS#show running-config dhcp
interface eth0
 ip address dhcp
 !
 !

ipv6 dhcp server pool DHCPv6-Server-2
 network 4001:: netmask 64
 address range low-address 4001::1 high-address 4001::124
ipv6 dhcp server pool DHCPv6-SER
 network 3001:: netmask 64
 address range low-address 3001::1 high-address 3001::124
interface xe11
 ipv6 dhcp server
 !
OcNOS#
```

DHCP Relay Agent Configuration for IPv6

This section shows how to configure the DHCPv6 relay agent.

DHCPv6 Relay Agent

OcNOS#configure terminal	Enter configure mode.
OcNOS (config)#ipv6 dhcp relay server-group dhcpv6-relay-gp	Configure relay server-group group name in global mode.
OcNOS (dhcp6-relay-group)#server 2001::2	Configure server address 2001 : : 2 .
OcNOS (dhcp6-relay-group)#commit	Commit the candidate configuration to the running configuration.
OcNOS (dhcp6-relay-group)#exit	Exit DHCPv6 relay group.
OcNOS (config)#interface xe8	Enter interface mode xe8 .
OcNOS (config-if)#ipv6 address 2001::3/64	Configure IPv6 address 2001 : : 3 /64 on the interface xe8 .
OcNOS (config-if)#ipv6 dhcp relay uplink	Configure relay uplink on the device connecting the

	server.
OcNOS (config-if)#ipv6 dhcp relay server-select dhcpv6-relay-gp	Configure relay server-select group name on the device connected to the server.
OcNOS (config-if)#commit	Commit the candidate configuration to the running configuration.
OcNOS (config-if)#exit	Exit interface mode.
OcNOS (config)#interface xe15	Enter interface mode.
OcNOS (config-if)#ipv6 address 3001::2/64	Configure IPv6 address on the interface xe15 .
OcNOS (config-if)#ipv6 dhcp relay	By default, this will be enabled. This command starts the IPv6 dhcp relay service.
OcNOS (config-if)#commit	Commit the candidate configuration to the running configuration.
OcNOS (config-if)#exit	Exit interface mode.
OcNOS (config)#ipv6 dhcp relay server-group dhcpv6-relay-gp	Configure relay server-group group name in global mode.
OcNOS (dhcp6-relay-group)#server 4001::2	Configure server address 4001 : : 2 .
OcNOS (dhcp6-relay-group)#commit	Commit the candidate configuration to the running configuration.
OcNOS (dhcp6-relay-group)#exit	Exit DHCPv6 relay group.
OcNOS (config)#interface xe11	Enter interface mode.
OcNOS (config-if)#ipv6 address 4001::3/64	Configure IPv6 4001 : : 3/64 address on the interface xe11 .
OcNOS (config-if)#ipv6 dhcp relay uplink	Configure relay uplink on the device connecting the server.
OcNOS (config-if)#ipv6 dhcp relay server-select dhcpv6-relay-gp	Configure relay server-select group name on the device connected to the server.
OcNOS (config-if)#commit	Commit the candidate configuration to the running configuration.
OcNOS (config-if)#exit	Exit interface mode.

Validation

The below shows the running configuration of the DHCPv6 relay agent node:

```
OcNOS#show running-config dhcp
interface eth0
 ip address dhcp
 !
 !

ipv6 dhcp relay server-group dhcpv6-relay-gp
 server 2001::2
 server 4001::2
interface xe8
 ipv6 dhcp relay uplink
 ipv6 dhcp relay server-select dhcpv6-relay-gp
 !
interface xe11
```

```

ipv6 dhcp relay uplink
ipv6 dhcp relay server-select dhcpv6-relay-gp
!
interface xe15
  ipv6 dhcp relay
OcNOS#show ipv6 dhcp relay
IPv6 DHCP relay service is Enabled.
VRF Name: default
  DHCPv6 IA_PD Route injection: Disabled
  Interface                Uplink/Downlink
  -----                -
  xe8                       Uplink
  xe11                      Uplink
  xe15                      Downlink
  Interface                Group-Name          Server
  -----                -
  xe11                    dhcpv6-relay-gp    2001::2,4001::2
OcNOS#

```

DHCP Client Configuration for IPv6

This section shows how to configure the DHCPv6 client.

DHCPv6 client

OcNOS#configure terminal	Enter configure mode.
OcNOS (config)#feature dhcp	Enable the feature dhcp. This is enabled by default.
OcNOS (config)#int xe15	Enter interface mode xe15 .
OcNOS (config-if)#ipv6 address dhcp	The client requests for the IPv6 address to the server. Once it receives the acknowledgment from the server, it assigns the IPv6 address to the interface in which this command is enabled.
OcNOS (config-if)#commit	Commit the candidate configuration to the running configuration.
OcNOS (config-if)#exit	Exit interface mode.

Validation

The below shows the running configuration of the DHCPv6 client node:

```

OcNOS#show running-config dhcp
interface eth0
  ip address dhcp
!
interface xe15
  ipv6 address dhcp

OcNOS#show ipv6 int br
Interface                IPv6-Address          Admin-Sta
tus
cd1                      unassigned            [up/down]
cd3                      unassigned            [up/down]
ce0                      unassigned            [up/down]
ce2                      unassigned            [up/down]

```

```

eth0                fe80::d277:ceff:fe9f:4500          [up/up]
lo                  ::1                                [up/up]
lo.management       ::1                                [up/up]
xe4                  unassigned                          [up/down]
xe5                  unassigned                          [up/down]
xe6                  unassigned                          [up/down]
xe7                  unassigned                          [up/down]
xe8                  unassigned                          [up/down]
xe9                  unassigned                          [up/down]
xe10                 unassigned                          [up/down]
xe11                 unassigned                          [up/down]
xe12                 unassigned                          [up/down]
xe13                 unassigned                          [up/down]
xe14                 unassigned                          [up/down]
xe15                 *3001::124
                    fe80::d277:ceff:feda:4511          [up/up]
xe16                 unassigned                          [up/down]
xe17                 unassigned                          [up/down]
xe18                 unassigned                          [up/down]
xe19                 unassigned                          [up/down]
xe20                 unassigned                          [up/down]
xe21                 unassigned                          [up/down]
xe22                 unassigned                          [up/down]
xe23                 unassigned                          [up/down]
xe24                 unassigned                          [up/down]
xe25                 unassigned                          [up/down]
xe26                 unassigned                          [up/down]
xe27                 unassigned                          [up/down]

OcNOS#show ipv6 int xe15 br
Interface           IPv6-Address          Admin-Sta
tus
xe15                *3001::124
                    fe80::d277:ceff:feda:4511          [up/up]

```

New CLI Commands

ip dhcp relay server-group 377

ip dhcp relay server-select	378
ipv6 dhcp relay server-group	379
ipv6 dhcp relay server-select	380
server A.B.C.D	381
server X:X::X:X	382

ip dhcp relay server-group

Use this command to create the **DHCP**¹ IPv4 server group. This group lists the servers to which DHCP Relay forwards the **DHCP client**² requests.

Use the **no** form of this command to unconfigure the DHCP IPv4 server group.

Command Syntax

```
ip dhcp relay server-group GROUP_NAME
no ip dhcp relay server-group GROUP_NAME
```

Parameters

GROUP_NAME

Name of the DHCP server group (specify a maximum 63 alphanumeric characters).

Command Mode

Configure mode and **VRF**³ mode. In the configure mode, the DHCP IPv4 server group is created in the default VRF. In the configure-vrf mode, the DHCP IPv4 server group is created in the user-defined VRF.

Applicability

This command was introduced in OcNOS version 6.4.1.

Examples

The example below shows the creation of DHCP IPv4 server groups.

```
OcNOS(config)#ip vrf vrf1
OcNOS(config-vrf)#ip dhcp relay server-group Group1
OcNOS(dhcp-relay-group)#end
OcNOS#configure terminal
OcNOS(config)#ip dhcp relay server-group Group2
```

¹Dynamic Host Configuration Protocol

²A DHCP client is a hardware device or software that uses DHCP to get the network configuration information from a DHCP Server. VRF: VRF creates a logically isolated routing table within a single physical network device. Each VRF instance works as an independent routing instance that enables separate network traffic, maintains different routing tables, and provides network isolation.

³Virtual Routing and Forwarding

ip dhcp relay server-select

Use this command to attach the **DHCP**¹ IPv4 server group to the DHCP relay uplink interface.

Use the **no** form of this command to remove the DHCP IPv4 server group attached to the DHCP relay interface.



Note: Attach the groups only to the DHCP relay uplink interfaces.

Command Syntax

```
ip dhcp relay server-select GROUP_NAME
no ip dhcp relay server-select
```

Parameters

GROUP_NAME

Name of the DHCP server group (specify a maximum 63 alphanumeric characters).

Command Mode

Interface mode

Applicability

This command was introduced in OcNOS version 6.4.1.

Examples

The below example shows attaching the DHCP IPv4 server group to the DHCP relay uplink interface:

```
OcNOS#configure terminal
OcNOS(config)#interface xel
OcNOS(config-if)#ip dhcp relay server-select group1
```

¹Dynamic Host Configuration Protocol

ipv6 dhcp relay server-group

Use this command to create the **DHCP**¹ IPv6 server group. This group lists the servers to which DHCP relay forwards the **DHCP client**² requests.

Use the no form of this command to unconfigure the DHCP IPv6 server group.

Command Syntax

```
ipv6 dhcp relay server-group GROUP_NAME
no ipv6 dhcp relay server-group GROUP_NAME
```

Parameters

GROUP_NAME

Name of the DHCP server group (specify a maximum of 63 alphanumeric characters).

Command Mode

Configure mode and **VRF**³ mode. In the configure mode, the DHCP IPv6 server group is created in the default VRF. In the configure-vrf mode, the DHCP IPv6 server group is created in the user-defined VRF.

Applicability

This command was introduced in OcNOS version 6.4.1.

Examples

The example below shows the creation of DHCP IPv6 server groups:

```
OcNOS#configure terminal
OcNOS(config)#ip vrf vrf1
OcNOS(config-vrf)#ipv6 dhcp relay server-group Group1
OcNOS(dhcp relay server-group)#end
OcNOS#configure terminal
OcNOS(config)#ipv6 dhcp relay server-group Group2
```

¹Dynamic Host Configuration Protocol

²A DHCP client is a hardware device or software that uses DHCP to get the network configuration information from a DHCP Server. VRF: VRF creates a logically isolated routing table within a single physical network device. Each VRF instance works as an independent routing instance that enables separate network traffic, maintains different routing tables, and provides network isolation.

³Virtual Routing and Forwarding

ipv6 dhcp relay server-select

Use this command to attach the **DHCP**¹ IPv6 group to the DHCP relay uplink interface.

Use the **no** form of this command to remove the DHCP IPv6 group attached to the interface.



Note: Attach the groups only to the DHCP relay uplink interfaces.

Command Syntax

```
ipv6 dhcp relay server-select GROUP_NAME
no ipv6 dhcp relay server-select
```

Parameters

GROUP_NAME

Name of the DHCP server group (specify a maximum of 63 alphanumeric characters).

Command Mode

Interface mode

Applicability

This command was introduced in OcNOS version 6.4.1.

Examples

The below example shows how to attach the DHCP IPv6 server group to the DHCP relay uplink interface:

```
#configure terminal
(config)#interface xel
(config-if)#ipv6 dhcp relay server-select group1
```

¹Dynamic Host Configuration Protocol

server A.B.C.D

Use this command to add the **DHCP**¹ IPv4 servers to the DHCP server group.

Use the **no** form of this command to remove the DHCP IPv4 servers from the DHCP server Group.



Note: A maximum of eight servers can be added to a DHCP group.

Command Syntax

```
server A.B.C.D
no server A.B.C.D
```

Parameters

A.B.C.D

DHCP IPv4 Relay group server address to be added in the DHCP server group.

Command Mode

DHCP Relay Group Mode.

Applicability

This command was introduced in OcNOS version 6.4.1.

Examples

The below example shows the addition of DHCP IPv4 servers to a DHCP server group:

```
OcNOS#configure terminal
OcNOS(config)#ip vrf vrf1
OcNOS(config-vrf)#ip dhcp relay server-group group
OcNOS(dhcp-relay-group)#server 10.12.23.205
OcNOS(dhcp-relay-group)#end
OcNOS#configure terminal
OcNOS(config)#ip dhcp relay server-group group1
OcNOS(dhcp-relay-group)#server 10.12.33.204
```

¹Dynamic Host Configuration Protocol

server X:X::X:X

Use this command to add the **DHCP**¹ IPv6 servers to the DHCP server group.

Use the **no** form of this command to remove the DHCP IPv6 servers from the DHCP server group.



Note: A maximum of eight servers can be added to a DHCP group.

Command Syntax

```
server X:X::X:X
no server X:X::X:X
```

Parameters

X:X::X:X

DHCP IPv6 Relay Group server address to be added in the DHCP server group.

Command Mode

DHCP Relay Group Mode

Applicability

This command was introduced in OcNOS version 6.4.1.

Examples

The below example shows the addition of DHCP IPv6 servers to a DHCP server group:

```
OcNOS#configure terminal
OcNOS(config)#ip vrf vrf1
OcNOS(config-vrf)#ipv6 dhcp relay server-group group
OcNOS(dhcp6-relay-group)#server 2003::1
OcNOS(dhcp6-relay-group)#end

OcNOS#configure terminal
OcNOS(config)#ipv6 dhcp relay server-group group1
OcNOS(dhcp-relay-group)#server 2001::1
OcNOS(dhcp6-relay-group)end
```

¹Dynamic Host Configuration Protocol

DHCP Relay Agent Configuration

Overview

The **DHCP¹** Relay feature was designed to forward DHCP broadcast requests as unicast packets to a configured DHCP server or servers for redundancy in different network segments..

DHCP Relay for IPv4

Before configuring **DHCP²** Relay, make sure DHCP server and client configurations are done.

Figure 24. DHCP Relay Configuration

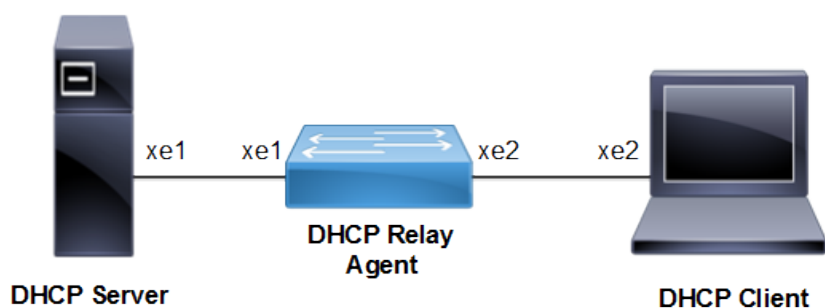

DHCP Agent

#configure terminal	Enter configure mode.
(config)#feature dhcp	Enable the feature dhcp. This is enabled by default.
(config)#ip dhcp relay	By default this will be enabled. It starts the ip dhcp relay service.
(config)#ip dhcp relay address 10.10.10.2	The relay address configured should be server interface address connected to DUT machine.
(config)#interface xe1	Enter interface mode.
(config-if)#ip address 10.10.10.1/24	Configure ipv4 address on the interface xe1.
(config-if)#ip dhcp relay uplink	Configure relay uplink on the device connecting the server.
(config-if)#exit	Exit interface mode.
(config)#commit	Commit the candidate configuration to the running configuration
(config)#interface xe2	Enter interface mode.

¹Dynamic Host Configuration Protocol

²Dynamic Host Configuration Protocol

<code>(config-if)#ip address 20.20.20.1/24</code>	Configure ipv4 address on the interface xe2.
<code>(config-if)#ip dhcp relay</code>	Relay should be configured on the interface connecting to the client.
<code>(config-if)#exit</code>	Exit interface mode.
<code>(config)#commit</code>	Commit the candidate configuration to the running configuration

Validation Commands

```
#show running-config dhcp

ip dhcp relay address 10.10.10.2
interface xe2
 ip dhcp relay
!
interface xe1
 ip dhcp relay uplink
!

#show ip dhcp relay
DHCP relay service is Enabled.
VRF Name: default
 Option 82: Disabled
DHCP Servers configured: 10.10.10.2
Interface                Uplink/Downlink
-----                -
xe2                      Downlink
xe1                      Uplink

#show ip dhcp relay address
VRF Name: default
DHCP Servers configured: 10.10.10.2
```

DHCP Relay for IPv6 Configuration

DHCP Agent

<code>#configure terminal</code>	Enter configure mode.
<code>(config)#feature dhcp</code>	Enable the feature dhcp. This is enabled in default.
<code>(config)#ipv6 dhcp relay</code>	By default this will be enabled. It starts the ipv6 dhcp relay service.
<code>(config)#ipv6 dhcp relay address 2001::2</code>	The relay address configured should be server interface address connected to DUT machine.
<code>(config)#interface xe1</code>	Enter interface mode.
<code>(config-if)#ipv6 address 2001::1/64</code>	Configure ipv6 address on the interface xe1.
<code>(config-if)#ipv6 dhcp relay uplink</code>	Configure relay uplink on the device connecting the server.
<code>(config-if)#exit</code>	Exit interface mode.
<code>(config)#commit</code>	Commit the candidate configuration to the running configuration

(config)#interface xe2	Enter interface mode.
(config-if)#ipv6 address 2002::1/64	Configure ipv6 address on the interface xe2.
(config-if)#ipv6 dhcp relay	Relay should be configured on the interface connecting to the client.
(config-if)#exit	Exit interface mode.
(config)#commit	Commit the candidate configuration to the running configuration

Validation Commands

```
#sh ipv6 dhcp relay address

VRF Name: default
  DHCPv6 Servers configured: 2001::2

#show running-config dhcp

Ipv6 dhcp relay address 2001::2
  interface xe2
  ipv6 dhcp relay
  !
interface xe1
  ipv6 dhcp relay uplink
  !
```

DHCP Relay option 82

This section contains examples of **DHCP**¹ Relay option-82 configuration. DHCP option 82 (Agent Information Option) provides additional security when DHCP is used to allocate network addresses. It enables the **DHCP relay agent**² to prevent **DHCP client**³ requests from untrusted sources. Service Providers use remote identifier (option 82 sub option 2) for troubleshooting, authentication, and accounting. The DHCP Option 82 Remote ID Format feature adds support for the interpretation of **remote-IDs** that are inserted by end users. On the relay agent, you can configure information option to add option 82 information to DHCP requests from the clients before forwarding the requests to the DHCP server. When configured with option 82 and remote-id, the server will receive the DHCP request packet with Agent Circuit ID and remote-id.

The two examples below, show how to configure the DHCP Relay option 82:

- Configuration of DHCP Relay option 82 on a physical interface with Agent information and remote-id.
- Configuration of DHCP Relay option 82 on a VLAN interface with Agent information and remote-id.

¹Dynamic Host Configuration Protocol

²A DHCP relay forwards the request from a DHCP client to the DHCP server group and takes the response from the DHCP server group to the DHCP client.

³A DHCP client is a hardware device or software that uses DHCP to get the network configuration information from a DHCP Server. VRF: VRF creates a logically isolated routing table within a single physical network device. Each VRF instance works as an independent routing instance that enables separate network traffic, maintains different routing tables, and provides network isolation.

Topology

Figure 25. DHCP Option 82 interface topology

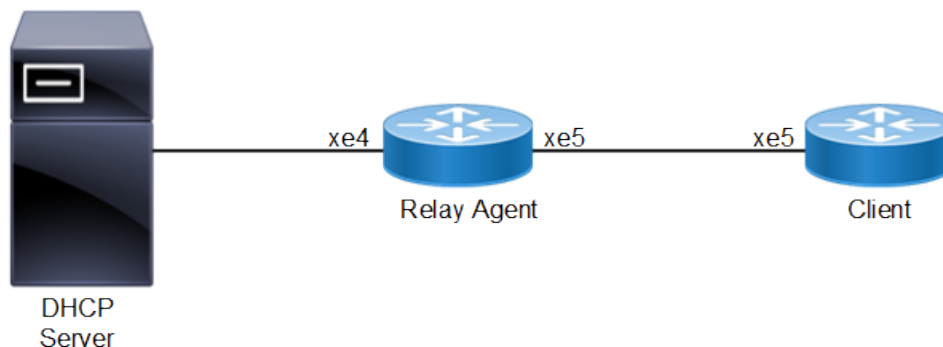

Physical Interface Configuration

Here, the DHCP Server is running with IP 192.168.1.2 with another pool of subnet 10.10.20.0 configured in the server. Configure a static route to 10.10.20.0 network for **DHCP OFFER** packets to reach the Relay Agent.

Relay agent

<code>#configure terminal</code>	Enter configure mode.
<code>(config)#ip dhcp relay</code>	Enable DHCP Relay
<code>(config)#ip dhcp relay address 192.168.1.2</code>	The relay address configured should be server interface address connected to DUT machine
<code>(config)#ip dhcp relay information option remote-id hostname</code>	Enable DHCP Relay information option with both agent circuit id which is sub option 1 of option 82 and remote-id which is sub option 2 of option 82. String support is also provided for remote-id.
<code>(config)#interface xe5</code>	Enter interface mode.
<code>(config-if)#ip address 10.10.20.2/24</code>	Add IP address
<code>(config-if)#ip dhcp relay</code>	Configure DHCP relay for the interface connecting to client.
<code>(config-if)#exit</code>	Exit from interface mode
<code>(config)#commit</code>	Commit the candidate configuration to the running configuration
<code>(config)#interface xe4</code>	Enter interface mode
<code>(config-if)#ip address 192.168.1.1/24</code>	Configure ipv4 address on the interface xe4
<code>(config-if)#ip dhcp relay uplink</code>	Configure DHCP relay uplink for the interface connecting to server.

(config-if)#exit	Exit interface mode.
(config)#commit	Commit the candidate configuration to the running configuration

Client

#configure terminal	Enter configure mode.
(config)#interface xe5	Enter interface mode.
(config-if)#ip address dhcp	Configure IP address DHCP
(config-if)#exit	Exit from interface mode
(config)#commit	Commit the candidate configuration to the running configuration

Validation

Relay Agent

```
#show running-config dhcp
!
ip dhcp relay information option remote-id hostname
ip dhcp relay address 192.168.1.2
interface xe5
  ip dhcp relay
!
interface xe4
  ip dhcp relay uplink
!
```

```
#show ip dhcp relay
DHCP relay service is Enabled.
VRF Name: default
  Option 82: Enabled
  Remote Id: OcNOS
  DHCP Servers configured: 192.168.1.2
  Interface                Uplink/Downlink
  -----
  xe5                       Downlink
  xe4                       Uplink
```

Client

```
#show ip interface brief | include xe5
xe5          *10.10.20.10    up          up

Packet captured at DHCP Server

Bootstrap Protocol (Discover)
  Message type: Boot Request (1)
  Hardware type: Ethernet (0x01)
  Hardware address length: 6
  Hops: 1
  Transaction ID: 0x4e61176c
  Seconds elapsed: 0
  Bootp flags: 0x0000 (Unicast)
  0... .... = Broadcast flag: Unicast
```

```
.000 0000 0000 0000 = Reserved flags: 0x0000
Client IP address: 0.0.0.0 (0.0.0.0)
Your (client) IP address: 0.0.0.0 (0.0.0.0)
Next server IP address: 0.0.0.0 (0.0.0.0)
Relay agent IP address: 10.10.20.2 (10.10.20.2)
Client MAC address: b8:6a:97:35:d7:9d (b8:6a:97:35:d7:9d)
Client hardware address padding: 00000000000000000000
Server host name not given
Boot file name not given
Magic cookie: DHCP
Option: (53) DHCP Message Type (Discover)
    Length: 1
    DHCP: Discover (1)
Option: (55) Parameter Request List
    Length: 3
    Parameter Request List Item: (1) Subnet Mask
    Parameter Request List Item: (28) Broadcast Address
    Parameter Request List Item: (3) Router
Option: (60) Vendor class identifier
    Length: 39
    Vendor class identifier: onie_vendor:x86_64-accton_as7326_56x-r0
Option: (82) Agent Information Option
    Length: 12
    Option 82 Suboption: (1) Agent Circuit ID
        Length: 3
        Agent Circuit ID: 786535
    Option 82 Suboption: (2) Agent Remote ID
        Length: 5
        Agent Remote ID: 4f634e4f53
Option: (255) End
    Option End: 255
Padding
```

Physical Interface Configuration with non-default VRF

Here, the **DHCP**¹ Server is running with IP 192.168.1.2 with another pool of subnet 10.10.20.0 configured in the server. Configure a static route to 10.10.20.0 network for DHCP OFFER packets to reach the Relay Agent.

Relay agent

#configure terminal	Enter configure mode.
(config)#ip dhcp relay	Enable DHCP Relay.
(config)#ip vrf vrf_dhcp	Configuring non default vrf vrf_dhcp
(config-vrf)#ip dhcp relay information option remote-id hostname	Enable DHCP Relay information option with both agent circuit id which is sub option 1 of option 82 and remote-id which is sub option 2 of option 82 on non default vrf.. String support is also provided for remote-id.
(config-vrf)#ip dhcp relay address 192.168.1.2	Configure DHCP relay address in non default vrf.
(config)#interface xe5	Enter interface mode.
(config-if)#ip vrf forwarding vrf_dhcp	Configure vrf forwarding for vrf_dhcp.
(config-if)#ip address 10.10.20.2/24	Add IP address.

¹Dynamic Host Configuration Protocol

(config-if)#ip dhcp relay	Configure DHCP relay for the interface connecting to client.
(config-if)#exit	Exit from interface mode
(config)#commit	Commit the candidate configuration to the running configuration
(config)#interface xe4	Enter interface mode
(config-if)#ip vrf forwarding vrf_dhcp	Configure vrf forwarding for vrf_dhcp
(config-if)#ip dhcp relay uplink	Configure DHCP relay uplink for the interface connecting to server.
(config-if)#ip address 192.168.1.4/24	Add IP address.
(config-if)#exit	Exit interface mode.
(config)#commit	Commit the candidate configuration to the running configuration

Client

#configure terminal	Enter configure mode.
(config)#interface xe5	Enter interface mode.
(config-if)#ip vrf forwarding vrf_dhcp	Configure ip vrf forwarding for non default vrf.
(config-if)#ip address dhcp	Configure IP address DHCP.
(config-if)#exit	Exit from interface mode.
(config)#commit	Commit the candidate configuration to the running configuration

Validation

Relay Agent

```
#show running-config dhcp
!
ip vrf vrf_dhcp
 ip dhcp relay information option remote-id hostname
 ip dhcp relay address 192.168.1.2
interface xe5
 ip dhcp relay
!
interface xe4
 ip dhcp relay uplink
!

#show ip dhcp relay
DHCP relay service is Enabled.
VRF Name: vrf_dhcp
Option 82: Enabled
Remote Id: OcNOS
DHCP Servers configured: 192.168.1.2
Interface          Uplink/Downlink
-----
xe5                 Downlink
xe4                 Uplink
```

Client

```
#show ip interface brief | include xe5
xe5          *10.10.20.10    up          up

Packet captured at DHCP Server

Bootstrap Protocol (Discover)
  Message type: Boot Request (1)
  Hardware type: Ethernet (0x01)
  Hardware address length: 6
  Hops: 1
  Transaction ID: 0x4e61176c
  Seconds elapsed: 0
  Bootp flags: 0x0000 (Unicast)
    0... .... .... .... = Broadcast flag: Unicast
    .000 0000 0000 0000 = Reserved flags: 0x0000
  Client IP address: 0.0.0.0 (0.0.0.0)
  Your (client) IP address: 0.0.0.0 (0.0.0.0)
  Next server IP address: 0.0.0.0 (0.0.0.0)
  Relay agent IP address: 10.10.20.2 (10.10.20.2)
  Client MAC address: b8:6a:97:35:d7:9d (b8:6a:97:35:d7:9d)
  Client hardware address padding: 00000000000000000000
  Server host name not given
  Boot file name not given
  Magic cookie: DHCP
  Option: (53) DHCP Message Type (Discover)
    Length: 1
    DHCP: Discover (1)
  Option: (55) Parameter Request List
    Length: 3
    Parameter Request List Item: (1) Subnet Mask
    Parameter Request List Item: (28) Broadcast Address
    Parameter Request List Item: (3) Router
  Option: (60) Vendor class identifier
    Length: 39
    Vendor class identifier: onie_vendor:x86_64-accton_as7326_56x-r0
  Option: (82) Agent Information Option
    Length: 12
    Option 82 Suboption: (1) Agent Circuit ID
      Length: 3
      Agent Circuit ID: 786535
    Option 82 Suboption: (2) Agent Remote ID
      Length: 5
      Agent Remote ID: 4f634e4f53
  Option: (255) End
    Option End: 255
  Padding

Sample DHCP configuration for using Remote-id

class "remote-id" {
  match if option agent.remote-id = OcNOS
} # remote-id

subnet 10.10.20.0 netmask 255.255.255.0 {
  pool {
    allow members of          "remote-id";
    default-lease-time       600;
    max-lease-time           7200;
    range                     10.10.20.3 10.10.10.100;
    option routers            10.10.20.2;
    option broadcast-address  10.10.20.255;
    option subnet-mask        255.255.255.0;
    option domain-name-servers 4.2.2.2;
  }
}
```

VLAN Interface Configuration

Topology

Figure 26. DHCP 82 vlan topology

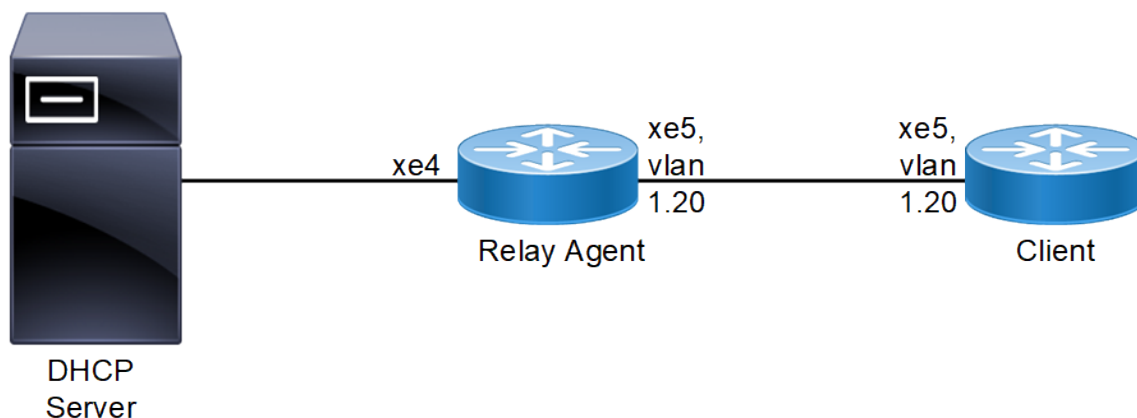

Here, the DHCP Server is running with IP 192.168.1.2 with another pool of subnets 10.10.20.0 configured in the server. Configure a static route to 10.10.20.0 network for DHCP OFFER packets to reach the Relay Agent. In the above topology, vlan 20 is part of interface xe5 in relay Agent and xe5 in Client.

Relay Agent

#configure terminal	Enter configure mode.
(config)#ip dhcp relay	Enable DHCP Relay
(config)#ip dhcp relay information option remote-id hostname	Enable DHCP Relay information option with both agent circuit id which is sub option 1 of option 82 and remote-id which is sub option 2 of option 82. String support is also provided for remote-id.
(config)#ip dhcp relay address 192.168.1.2	Configure DHCP relay address
(config)#bridge 1 protocol rstp vlan-bridge	Configure bridge
(config)#vlan 2-100 bridge 1 state enable	Enable some VLANs
(config)#interface xe5	Enter interface mode
(config-if)#switchport	Configure switchport
(config-if)#bridge-group 1	Configure bridge-group
(config-if)#switchport mode hybrid	Configure switchport mode
(config-if)#switchport hybrid allowed vlan all	Enable vlan
(config-if)#exit	Exit from interface mode
(config)#commit	Commit the candidate configuration to the running configuration
(config)#interface vlan1.20	Enter interface mode for the vlan interface towards client.
(config-if)#ip address 10.10.20.2/24	Add IP address

<code>(config-if)#ip dhcp relay</code>	Configure DHCP relay on the vlan interface connecting to client.
<code>(config-if)#exit</code>	Exit from interface mode
<code>(config)#commit</code>	Commit the candidate configuration to the running configuration
<code>(config)#interface xe4</code>	Enter interface mode
<code>(config-if)#ip dhcp relay uplink</code>	Configure DHCP relay uplink for the interface connecting to server.
<code>(config-if)#ip address 192.168.1.4/24</code>	Add IP address
<code>(config-if)#exit</code>	Exit interface mode.
<code>(config)#commit</code>	Commit the candidate configuration to the running configuration

Client

<code>#configure terminal</code>	Enter configure mode.
<code>(config)#bridge 1 protocol rstp vlan-bridge</code>	Configure bridge
<code>(config)#vlan 2-100 bridge 1 state enable</code>	Enable VLANs
<code>(config)#interface xe5</code>	Enter interface mode.
<code>(config-if)#switchport</code>	Configure switchport
<code>(config-if)#bridge-group 1</code>	Configure bridge-group
<code>(config-if)#switchport mode hybrid</code>	Configure switchport mode
<code>(config-if)#switchport hybrid allowed vlan add 20 egress-tagged enable</code>	Enable vlan
<code>(config-if)#exit</code>	Exit from interface mode
<code>(config)#commit</code>	Commit the candidate configuration to the running configuration
<code>(config)#interface vlan1.20</code>	Enter interface mode for the vlan interface which connects relay.
<code>(config-if)#ip address dhcp</code>	Configure IP address DHCP
<code>(config-if)#exit</code>	Exit from interface mode
<code>(config)#commit</code>	Commit the candidate configuration to the running configuration

DHCP-Relay with different VRFs

This chapter explains about **DHCP**¹ Relay package to make Relay talk to different VRFs when Client and Server are running in different VRFs.

¹Dynamic Host Configuration Protocol

DHCP Relay for IPv4 with different VRFs

Before configuring DHCP Relay, make sure DHCP server and client configurations are done.

Figure 27. DHCP Relay Configuration

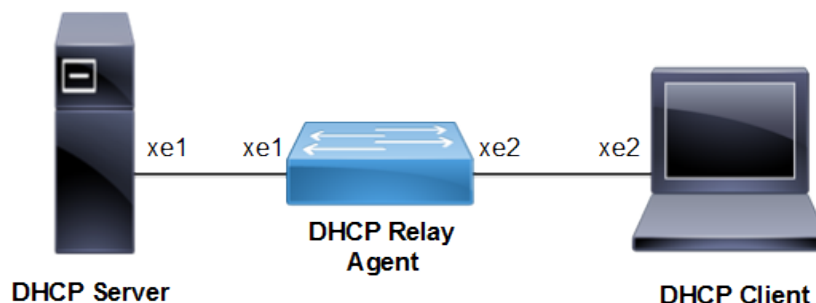

DHCP Agent

#configure terminal	Enter configure mode.
(config)#feature dhcp	Enable the feature dhcp. This is enabled in default.
(config)#ipv4 dhcp relay	By default this will be enabled. It starts the ipv4 dhcp relay service.
(config)# ip vrf vrf1	Configure IP VRF ¹
(config)# ip dhcp relay address 10.10.10.2 global	Configure DHCP relay address
(config)#interface xe1	Enter interface mode.
(config-if)#ip address 10.10.10.1/24	Configure ipv4 address on the interface xe1.
(config-if)#ip dhcp relay uplink	Configure relay uplink on the device connecting the server.
(config-if)#exit	Exit interface mode.
(config)#commit	Commit the candidate configuration to the running
(config)#interface xe2	Enter interface mode.
(config)#ip vrf forwarding vrf1	Configure IP VRF forwarding
(config-if)#ip address 20.20.20.1/24	Configure ipv4 address on the interface xe2.
(config-if)#ip dhcp relay	Relay should be configured on the interface connecting to the client.
(config-if)#exit	Exit interface mode.
(config)#commit	Commit the candidate configuration to the running

Validation Commands

```
#show running-config dhcp
  interface eth0
    ip address dhcp
```

¹Virtual Routing and Forwarding

```

!
ip vrf vrf1
ip dhcp relay address 10.10.10.2 global
!
interface xe2
ip dhcp relay
!
interface xe1
ip dhcp relay uplink
!

#show ip dhcp relay
DHCP relay service is Enabled. VRF Name: vrf1
Option 82: Disabled
DHCP Servers configured:
10.10.10.2 default
Interface  Uplink/Downlink

xe2  Downlink
VRF Name: default
Interface  Uplink/Downlink

xe1  Uplink

Incoming DHCPv4 packets which already contain relay agent option are FORWARDED
unchanged.
#show ip dhcp relay address
VRF Name: vrf1
  DHCP Servers configured:
    10.10.10.2      default
Incoming DHCPv4 packets which already contain relay agent option are FORWARDED unchanged.
    
```

DHCP Relay for IPv6 Configuration with different VRFs

DHCP Agent

#configure terminal	Enter configure mode.
(config)#feature dhcp	Enable the feature dhcp. This is enabled in default.
(config)#ipv6 dhcp relay	By default, this will be enabled. It starts the ipv6 dhcp relay service.
(config)#ip vrf vrf1	Configure vrf1
(config)#ipv6 dhcp relay address 2001::2 global	The relay address configured should be server interface address which is in default vrf , connected to DUT machine.
(config)#interface xe1	Enter interface mode.
(config-if)#ipv6 address 2001::1/64	Configure ipv6 address on the interface xe1.
(config-if)#ipv6 dhcp relay uplink	Configure relay uplink on the device connecting the server.
(config-if)#exit	Exit interface mode.
(config)#commit	Commit the candidate configuration to the running configuration
(config)#interface xe2	Enter interface mode.

(config-if)# ip vrf forwarding vrf1	Attach vrf1 under downlink interface
(config-if)#ipv6 address 2002::1/64	Configure ipv6 address on the interface xe2.
(config-if)#ipv6 dhcp relay	Relay should be configured on the interface connecting client.
(config-if)#exit	Exit interface mode.
(config)#commit	Commit the candidate configuration to the running configuration

Validation Commands

```
#show ipv6 dhcp relay address
VRF Name: vrf1
  DHCPv6 Servers configured:
    2001::2    default
#show running-config dhcp
interface eth0
  ip address dhcp
!
ip vrf vrf1
ipv6 dhcp relay address 2001::1 global
interface xe2
ipv6 dhcp relay
!
interface xe1
ipv6 dhcp relay uplink
!

#show ipv6 dhcp relay
IPv6 DHCP relay service is Enabled.
VRF Name: vrf1
  DHCPv6 Servers configured:
    2001::2    default
  DHCPv6 IA_PD Route injection: Disabled
Interface          Uplink/Downlink
-----
Xe2                 Downlink
  DHCPv6 IA_PD Route injection: Disabled
Interface          Uplink/Downlink
-----
Xe1                 Uplink
```

DHCPv6 Prefix Delegation Configuration

Overview

The prefix delegation feature facilitates the Dynamic Host Control Protocol (**DHCP**¹) server capable of assigning prefixes to DHCP clients from a global pool, enabling the Customer Premise Equipment (CPE) to learn the prefix. This feature also supports the DHCP server in assigning multiple prefixes to a single client. The user configures the IPv6 address using the learned prefix on its **Local Area Network (LAN)**² interface with the subnet prefix. The LAN hosts are learning the subnetted prefix through **Router Advertisement (RA)**³ messages, an important **Neighbor Discovery Protocol (NDP)**⁴ component, enabling the device to auto-configure the number of IPv6 addresses from 1 to 64.

This feature would enable service providers to assign IP for the CPE that is acting as a router between the service providers' core network and the subscribers' internal network.

Feature Characteristics

- DHCPv6 **Identity association for non-temporary addresses (IA_NA)**⁵ assigns a global IPv6 address on the **Wide Area Network (WAN)**⁶ link. The address comes from a local pool specified in the DHCP Server.
- The **Requesting Router (RR)**⁷ uses the delegated prefix to define the subnet for the LAN based on the prefix received from the DHCP Server.
- The Requesting Router uses the delegated prefix to assign addresses to the LAN devices. The RR can send a Router Advertisement or the devices shall send a Router solicitation.

Benefits

The key benefits are as follows:

- This feature helps the Internet Service Providers (ISPs) to assign the dynamic IPv6 addresses to their customers automatically instead of statically assigning the address.
- This feature adds the capability to get the multiple DHCPv6 prefixes as per the customer requirement.
- This feature allows the centralized management of the IPv6 addresses.

Configuration

This section shows the configuration of the DHCPv6 prefix delegation.

¹Dynamic Host Configuration Protocol

²Local Area Network is a network of devices in a small area that may include a building or home.

³Router Advertisement is a critical component in the IPv6 network. The router sends a message to the devices connected to the LAN to communicate its presence and share the configurations with the LAN host.

⁴Neighbor Discovery Protocol is a crucial protocol in the IPv6 networks, helping establish the communication and auto-configuration to run the devices in the local network segment seamlessly.

⁵Identity association for non-temporary addresses is a unique identifier associated with a set of IPv6 addresses assigned to client devices permanently or for a long time.

⁶Wide Area Network refers to large network that includes multiple LANs and spans over a large geographical area.

⁷Requesting Router is a network device that requests the IPv6 address prefixes to the DHCP server to share it with the downstream devices.

Topology

The requesting router sends the prefix request to the delegating router, which sends the request to the **DHCP**¹ server. The DHCP server sends the prefix to the requesting router through the delegating router. The IPv6 address is created in the requesting router by combining the prefix learned from the server and the user-defined suffix. The host receives the IPv6 address from the requesting router.

Figure 28. DHCPv6 Prefix Delegation Configuration

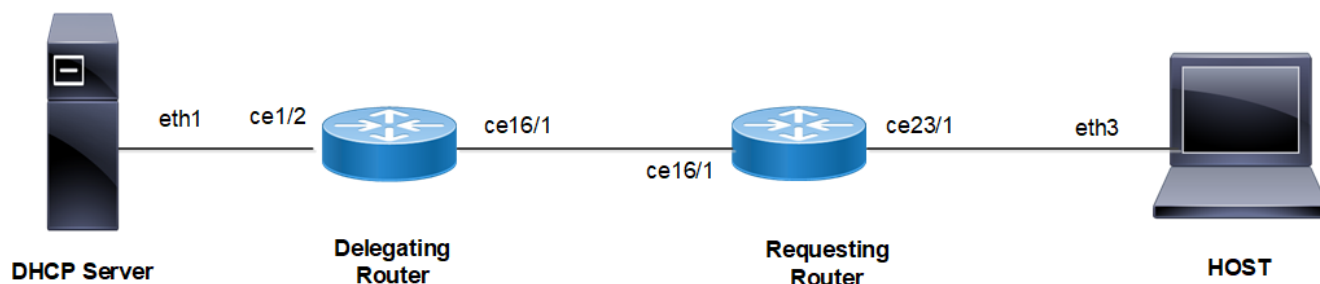

Configuring DHCP prefixes

Follow the steps to configure the DHCPv6 prefix delegation.

Configure the Delegating Router

1. Specify the server interface address connected to the delegating router.

```
(config)#ipv6 dhcp relay address 2001:101:0:1::131
```

2. Configure the DHCPv6 up-link interface from the delegating router to the DHCPv6 server using **ipv6 dhcp relay uplink** command.

```
(config)#interface ce1/2
(config-if)#ipv6 address 2001:101:0:1::130/64
(config-if)#ipv6 dhcp relay uplink
```

3. Configure the DHCPv6 down-link interface from the delegating router to the requesting router using **ipv6 dhcp relay** command.

```
(config)#interface ce16/1
(config-if)#ipv6 address 3001:101:0:1::135/64
(config-if)#ipv6 dhcp relay
```

4. Add a static route on the delegating router to reach the host device.

```
(config)#ipv6 route ::/0 3001:101:0:1::
```

Configure the Requesting Router device

1. In the WAN interface, configure the address prefix length option (**64**). Get the IPv6 address from the server using **ipv6 address dhcp** command. Enable the requesting router to request the prefix by using **ipv6**

¹Dynamic Host Configuration Protocol

dhcp prefix-delegation and configure the number of prefixes using **ipv6 dhcp client max-delegated-prefixes**.



- The default value of simultaneous prefixes delegated to a single client is 8. The minimum of simultaneous prefixes delegated to a single client is 1 and the maximum is 64.
- If the configured **max-delegated-prefix count** is greater than 30, then configure the lease times greater than 180 seconds.

```
(config)#interface ce16/1
(config-if)#ipv6 dhcp address-prefix-len 64
(config-if)#ipv6 address dhcp
(config-if)#ipv6 dhcp prefix-delegation PREFIX_FROM_SERVER
(config-if)#ipv6 dhcp client max-delegated-prefixes 10
```

2. In the LAN interface, configure the command **ipv6 address** to create the IPv6 address by using the DHCP prefix learned from the server and user defined suffix.

```
(config)#interface ce23/1
(config-if)#ipv6 address PREFIX_FROM_SERVER ::1:0:0:0:1/64
```

3. Add a static route on the requesting router to reach the host device.

```
(config)#ipv6 route 2001:101:0:1::/64 3001:101:0:1::135
```

Configure the HOST

1. In the LAN interface, configure the auto-configuration to get the dynamic IPv6 address from the server.

```
(config)#interface eth3
(config-if)#ipv6 address autoconfig max-address 10
(config if)#exit
(config)#commit
```

2. Add a static route on the host to reach the server.

```
(config)#ipv6 route 2001:101:0:1::/64 3001:101:0:1::135
```

Running configurations

The running configuration for the Delegating Router is as follows:

```
#show running-config
!
ipv6 dhcp relay address 2001:101:0:1::131
!
interface ce1/2
  ipv6 address 2001:101:0:1::130/64
  ipv6 dhcp relay uplink
!
interface ce16/1
  ipv6 address 3001:101:0:1::135/64
  ipv6 dhcp relay
  commit
end
!
```

The running configuration for the Requesting Router is as follows:

```
#show running-config
!
interface ce16/1
```

```

ipv6 dhcp client max-delegated-prefixes 10
ipv6 address dhcp
ipv6 dhcp address-prefix-len 64
ipv6 dhcp prefix-delegation PREFIX_FROM_SERVER
!
interface ce23/1
  ipv6 address PREFIX_FROM_SERVER ::1:0:0:0:1/64
  commit
end
!

```

The running configuration for the HOST is as follows:

```

#show running-config
!
interface eth3
  ipv6 address autoconfig max-address 10
  commit
end
!

```

Validation

Validate the show output after configuration as shown below.

Delegating Router

```

#show ipv6 route
IPv6 Routing Table
Codes: K - kernel route, C - connected, S - static, D- DHCP, R - RIP,
       O - OSPF, IA - OSPF inter area, E1 - OSPF external type 1,
       E2 - OSPF external type 2, E - EVPN  N1 - OSPF NSSA external type 1,
       N2 - OSPF NSSA external type 2, i - IS-IS, B - BGP,
       v - vrf leaked
Timers: Uptime

IP Route Table for VRF "default"
C      ::1/128 via ::, lo, 00:03:20
C      2001:101:0:1::/64 via ::, ce1/2, 00:02:58
D      2001:db9:c0f::/48 [80/0] via fe80::eac5:7aff:fe51:723b, ce16/1, 00:00:44
C      3001:101:0:1::/64 via ::, ce16/1, 00:00:50
C      fe80::/64 via ::, ce16/1, 00:00:50
#show ipv6 dhcp pd-route
VRF : default
  2001:db9:c0a::/48 via 2001:db9:c0b::, ce16/1, (2024-03-07 06:20:43 - 2024-03-07 06:22:13)
  2001:db9:c0b::/48 via 2001:db9:c09::, ce16/1, (2024-03-07 06:20:42 - 2024-03-07 06:22:12)
  2001:db9:c0c::/48 via 2001:db9:c0d::, ce16/1, (2024-03-07 06:20:39 - 2024-03-07 06:22:09)
  2001:db9:c0d::/48 via 2001:db9:c0e::, ce16/1, (2024-03-07 06:20:38 - 2024-03-07 06:22:08)
  2001:db9:c0e::/48 via 2001:db9:c0f::, ce16/1, (2024-03-07 06:20:37 - 2024-03-07 06:22:07)
  2001:db9:c0f::/48 via fe80::eac5:7aff:fe51:723b, ce16/1, (2024-03-07 06:20:36 - 2024-03-07
06:22:06)
  2001:db9:c05::/48 via 2001:db9:c06::, ce16/1, (2024-03-07 06:20:45 - 2024-03-07 06:22:15)
  2001:db9:c06::/48 via 2001:db9:c0a::, ce16/1, (2024-03-07 06:20:44 - 2024-03-07 06:22:14)
  2001:db9:c08::/48 via 2001:db9:c0c::, ce16/1, (2024-03-07 06:20:40 - 2024-03-07 06:22:10)
  2001:db9:c09::/48 via 2001:db9:c08::, ce16/1, (2024-03-07 06:20:41 - 2024-03-07 06:22:11)
#show ipv6 dhcp relay
IPv6 DHCP relay service is Enabled.
VRF Name: default
  DHCPv6 Servers configured:
    2001:101:0:1::131
  DHCPv6 IA_PD Route injection: Enabled
  DHCPv6 Duplicate Clients detection: Disabled
Interface          Uplink/Downlink
-----
ce16/1              Downlink
ce1/2               Uplink

```

Requesting Router

```
#show ipv6 dhcp interface

ce16/1 is in client mode
  prefix name: PREFIX_FROM_SERVER
  learned prefix: 2001:db9:c05::/48
  preferred lifetime 0, valid lifetime 60
  interfaces using the learned prefix
    ce23/1    2001:db9:c0f:1::1
    ce23/1    2001:db9:c0e:1::1
    ce23/1    2001:db9:c0d:1::1
    ce23/1    2001:db9:c0c:1::1
    ce23/1    2001:db9:c08:1::1
    ce23/1    2001:db9:c09:1::1
    ce23/1    2001:db9:c0b:1::1
    ce23/1    2001:db9:c0a:1::1
    ce23/1    2001:db9:c06:1::1
    ce23/1    2001:db9:c05:1::1

#show interface ce23/1
Interface ce23/1
  Flexport: Non Control Port (Active)
  Hardware is ETH Current HW addr: e8c5.7a51.722e
  Physical:e8c5.7a51.722e Logical:(not set)
  Forward Error Correction (FEC) configured is Auto (default)
  FEC status is N/A
  Port Mode is Router
  Protected Mode is Promiscuous
  Interface index: 10017
  Metric 1 mtu 1500 duplex-full link-speed 10g
  Debounce timer: disable
  ARP ageing timeout 1500
  <UP,BROADCAST,RUNNING,ALLMULTI,MULTICAST>
  VRF Binding: Not bound
  Label switching is disabled
  No Virtual Circuit configured
  Administrative Group(s): None
  Bandwidth 10g
  Maximum reservable bandwidth 10g
    Available b/w at priority 0 is 10g
    Available b/w at priority 1 is 10g
    Available b/w at priority 2 is 10g
    Available b/w at priority 3 is 10g
    Available b/w at priority 4 is 10g
    Available b/w at priority 5 is 10g
    Available b/w at priority 6 is 10g
    Available b/w at priority 7 is 10g
  DHCP client is disabled.
  Last Flapped: Never
  Statistics last cleared: Never
  inet6 2001:db9:c05:1::1/64
  inet6 2001:db9:c06:1::1/64
  inet6 2001:db9:c08:1::1/64
  inet6 2001:db9:c09:1::1/64
  inet6 2001:db9:c0a:1::1/64
  inet6 2001:db9:c0b:1::1/64
  inet6 2001:db9:c0c:1::1/64
  inet6 2001:db9:c0d:1::1/64
  inet6 2001:db9:c0e:1::1/64
  inet6 2001:db9:c0f:1::1/64
  inet6 fe80::eac5:7aff:fe51:722e/64
  ND router advertisements are sent approximately every 561 seconds
  ND next router advertisement due in 517 seconds.
  ND router advertisements live for 1800 seconds
  Hosts use stateless autoconfig for addresses.
  5 minute input rate 82 bits/sec, 0 packets/sec
```

```

5 minute output rate 191 bits/sec, 0 packets/sec
RX
unicast packets 0 multicast packets 25 broadcast packets 0
input packets 25 bytes 2862
jumbo packets 0
undersize 0 oversize 0 CRC 0 fragments 0 jabbers 0
input error 0
input with dribble 0 input discard 0
Rx pause 0
TX
unicast packets 0 multicast packets 38 broadcast packets 0
output packets 38 bytes 5540
jumbo packets 0
output errors 0 collision 0 deferred 0 late collision 0
output discard 0
Tx pause 0
    
```

HOST

```

#show ipv6 interface eth3 brief
Interface          IPv6-Address                               Admin-Status
eth3                2001:db9:c05:1:923c:b3ff:fe90:9fa9
                   2001:db9:c06:1:923c:b3ff:fe90:9fa9
                   2001:db9:c08:1:923c:b3ff:fe90:9fa9
                   2001:db9:c09:1:923c:b3ff:fe90:9fa9
                   2001:db9:c0a:1:923c:b3ff:fe90:9fa9
                   2001:db9:c0b:1:923c:b3ff:fe90:9fa9
                   2001:db9:c0c:1:923c:b3ff:fe90:9fa9
                   2001:db9:c0d:1:923c:b3ff:fe90:9fa9
                   2001:db9:c0e:1:923c:b3ff:fe90:9fa9
                   2001:db9:c0f:1:923c:b3ff:fe90:9fa9
                   fe80::923c:b3ff:fe90:9fa9                [up/up]
    
```

Glossary

The following provides definitions for key terms or abbreviations and their meanings used throughout this document:

Key Terms/Acronym	Description
Border Network Gateway (BNG)¹	Border Network Gateway is a critical component in the telecommunication network that serves as the entry and exit point between the ISP² and the global network.
Customer Premises Equipment (CPE)³	Customer Premises Equipment is a networking device located on the customer premises. It is present on the edge of the service provider network, which connects the customer devices to the service provider network.
Delegating Router (DR)⁴	Delegating Router is a network device that delegates the IPv6 address prefixes to the downstream devices.

¹Border Network Gateway is a critical component in the telecommunication network that serves as the entry and exit point between the ISP and the global network.

²Internet Service Provider

³Customer Premises Equipment is a networking device located on the customer premises. It is present on the edge of the service provider network, which connects the customer devices to the service provider network.

⁴Delegating Router is a network device that delegates the IPv6 address prefixes to the downstream devices.

Key Terms/Acronym	Description
Identity association for non-temporary addresses (IA_NA)¹	Identity association for non-temporary addresses is a unique identifier associated with a set of IPv6 addresses assigned to client devices permanently or for a long time.
Local Area Network (LAN)²	Local Area Network is a network of devices in a small area that may include a building or home.
Neighbor Discovery Protocol (NDP)³	Neighbor Discovery Protocol is a crucial protocol in the IPv6 networks, helping establish the communication and auto-configuration to run the devices in the local network segment seamlessly.
Neighbor Discovery Router Advertisement (NDRA)⁴	Neighbor Discovery Router Advertisement facilitates a network device to advertise the routing information with the neighboring devices so that the neighboring devices take the forwarding decision in dynamic routing.
Router Advertisement (RA)⁵	Router Advertisement is a critical component in the IPv6 network. The router sends a message to the devices connected to the LAN to communicate its presence and share the configurations with the LAN host.
Requesting Router (RR)⁶	Requesting Router is a network device that requests the IPv6 address prefixes to the DHCP server to share it with the downstream devices.
Router Solicitation (RS)⁷	Router Solicitation is a component of the neighbor discovery protocol in the IPv6 network where the host sends a message to discover routers in the local area. When a router receives RS, it responds to the host with RA, which includes the configuration.
Wide Area Network (WAN)⁸	Wide Area Network refers to large network that includes multiple LANs and spans over a large geographical area.

¹Identity association for non-temporary addresses is a unique identifier associated with a set of IPv6 addresses assigned to client devices permanently or for a long time.

²Local Area Network is a network of devices in a small area that may include a building or home.

³Neighbor Discovery Protocol is a crucial protocol in the IPv6 networks, helping establish the communication and auto-configuration to run the devices in the local network segment seamlessly.

⁴Neighbor Discovery Router Advertisement facilitates a network device to advertise the routing information with the neighboring device so that the neighboring devices take the forwarding decision in dynamic routing.

⁵Router Advertisement is a critical component in the IPv6 network. The router sends a message to the devices connected to the LAN to communicate its presence and share the configurations with the LAN host.

⁶Requesting Router is a network device that requests the IPv6 address prefixes to the DHCP server to share it with the downstream devices.

⁷Router Solicitation is a component of the neighbor discovery protocol in the IPv6 network where the host sends a message to discover routers in the local area. When a router receives RS, it responds to the host with RA, which includes the configuration.

⁸Wide Area Network refers to large network that includes multiple LANs and spans over a large geographical area.

DHCPv6 Relay Prefix Delegation Route Injection Configuration

Overview

The prefix delegation feature lets a **DHCP**¹ server assign prefixes chosen from a global pool to DHCP clients. The **DHCP client**² can then configure an IPv6 address on its LAN interface using the prefix it received. It will then send router advertisements including the prefix, allowing other devices to auto-configure their own IPv6 addresses.

If the network topology where Prefix Delegation is running has a Relay agent, then a route needs to be injected in Delegating Router, so that the traffic from the DHCP server-side shall be forwarded towards the Requesting Router.

 **Notes:**

- Auto-injected routes cannot be leaked between VRFs.
- To ensure smooth auto injection of routes, the operator must ensure that unicast DHCP Renew packets are routed through the Delegating Router.

Topology

Figure 29. DHCPv6 Relay Delegating Configuration

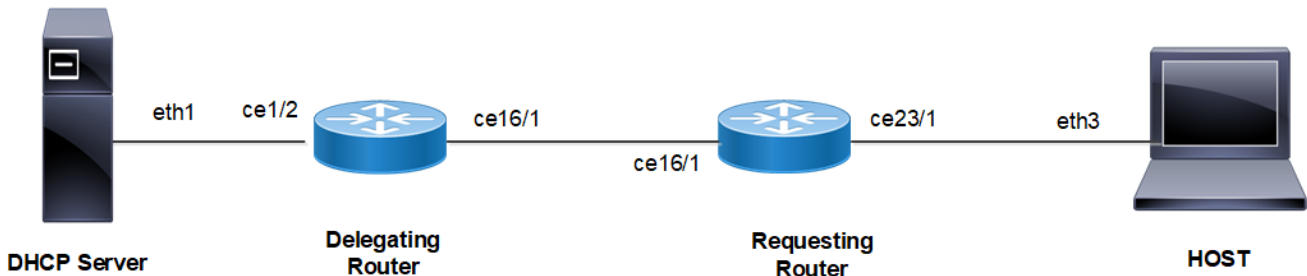

DHCP Relay - Delegating Router (DR)

#configure terminal	Enter configure mode.
(config)#feature dhcp	Enable the feature DHCP. This is enabled by default.
(config)#ipv6 dhcp relay	By default, this will be enabled. It starts the IPv6 DHCP relay service.

¹Dynamic Host Configuration Protocol

²A DHCP client is a hardware device or software that uses DHCP to get the network configuration information from a DHCP Server. VRF: VRF creates a logically isolated routing table within a single physical network device. Each VRF instance works as an independent routing instance that enables separate network traffic, maintains different routing tables, and provides network isolation.

(config)#ipv6 dhcp relay address 2001:101:0:1::131	The relay address configured should be server interface address connected to Delegating Router.
(config)#interface ce1/2	Enter interface mode.
(config-if)#ipv6 address 2001:101:0:1::130/64	Configure IPv6 address on the interface ce1/2
(config-if)#ipv6 dhcp relay uplink	Configure relay uplink on the device connecting the server.
(config-if)#exit	Exit interface mode.
(config)#commit	Commit the candidate configuration to the running configuration
(config)#interface ce16/1	Enter interface mode.
(config-if)#ipv6 address 3001:101:0:1::135/64	Configure IPv6 address on the interface ce16/1
(config-if)#ipv6 dhcp relay	Relay should be configured on the interface connecting to the client.
(config-if)#exit	Exit interface mode.
(config)#commit	Commit the candidate configuration to the running configuration
(config)#ipv6 dhcp relay pd-route-injection	Configure to enable auto route injection.

Requesting Router (RR)

#configure terminal	Enter configure mode.
(config)#interface ce16/1	Enter interface mode.
(config-if)#ipv6 address dhcp	Configure IPv6 address DHCP.
(config-if)#ipv6 dhcp prefix-delegation PREFIX_FROM_SERVER	Configure IPv6 DHCP prefix-delegation
(config-if)#exit	Exit interface mode.
(config)#commit	Commit the candidate configuration to the running configuration
(config)#interface ce23/1	Enter interface mode.
(config-if)#ipv6 address PREFIX_FROM_SERVER ::1:0:0:0:1/64	Configure IPv6 address from the prefix learnt
(config-if)#ipv6 nd ra-interval 4	Configure ra-interval
(config-if)#exit	Exit interface mode.
(config)#ipv6 route 2001:101:0:1::/64 3001:101:0:1::135	Configure static route towards server
(config)#commit	Commit the candidate configuration to the running configuration

HOST

#configure terminal	Enter configure mode.
---------------------	-----------------------

(config)#interface ce23/1	Enter interface mode.
(config-if)#ipv6 address autoconfig	Configure IPv6 autoconfig
(config if)#exit	Exit interface mode.
(config)#ipv6 route 2001:101:0:1::/64 fe80::ce37:abff:fec9:7426 ce23/1	Configure static route towards server
(config)#commit	Commit the candidate configuration to the running configuration

Linux Host

IPV6_AUTOCONF=yes	IPv6 autoconfig should be set to yes in interface config file.
-------------------	--

DHCP Server

ifconfig eth1 inet6 add 2001:101:0:1::131/64	Configure IPv6 address on client facing interface
dhcpd -d -6 -cf /etc/dhcp/dhcpd6.conf eth1	Start server
ipv6 route 1212:501:102:1::/64 2001:101:0:1::130	Configure static route towards Requesting Router

Sample dhcpd6.conf file

```
#
#DHCPv6 Server Configuration file.
#see /usr/share/doc/dhcp*/dhcpd6.conf.sample
#see dhcpd.conf(5) man page
#
preferred-lifetime 400;
default-lease-time 600;

subnet6 2001:101:0:1::/64 {
range6 2001:101:0:1::129 2001:101:0:1::254;
}
subnet6 3001:101:0:1::/64 {
range6 3001:101:0:1::129 3001:101:0:1::254;
prefix6 1212:501:101:: 1212:501:102:: /48;
option dhcp6.name-servers fec0:0:0:1::1;
option dhcp6.domain-search "domain.example";
}
```

Validation

Delegation Router (DR)

```
DR#sh ipv6 dhcp relay
IPv6 DHCP relay service is Enabled.
VRF Name: default
  DHCPv6 Servers configured: 2001:101:0:1::131
  DHCPv6 IA_PD Route injection: Enabled
Interface                Uplink/Downlink
-----                -
ce1/2                    Downlink
ce16/1                   Uplink

DR#sh ipv6 route
IPv6 Routing Table
```

```
Codes: K - kernel route, C - connected, S - static, D- DHCP, R - RIP,
       O - OSPF, IA - OSPF inter area, E1 - OSPF external type 1,
       E2 - OSPF external type 2, E - EVPN N1 - OSPF NSSA external type 1,
       N2 - OSPF NSSA external type 2, i - IS-IS, B - BGP
Timers: Uptime
```

```
IP Route Table for VRF "default"
C    ::1/128 via ::, lo, 19:24:04
D    1212:501:102::/48 [80/0] via fe80::eac5:7aff:fe64:4a20, ce16/1, 00:00:01
C    2001:101:0:1::/64 via ::, xe4, 03:42:58
C    3001:101:0:1::/64 via ::, xe2, 02:51:04
C    4001:101:0:1::/64 via ::, xe5, 03:14:41
C    fe80::/64 via ::, xe9, 00:41:39
```

```
#sh ipv6 dhcp pd-route
VRF : default
     1212:501:102::/48 via fe80::eac5:7aff:fe64:4a20, ce16/1, (2019-05-30 14:02:50 - 2
019-05-30 14:04:50)
```

Requesting Router (RR)

```
RR#show ipv6 dhcp interface
```

```
ce16/1 is in client mode
prefix name: PREFIX_FROM_SERVER1
learned prefix: 1212:501:102::/48
preferred lifetime 600, valid lifetime 600
interfaces using the learned prefix
ce23/1    1212:501:102:1::1
```

```
RR#sh ipv6 interface ce23/1 brief
Interface          IPv6-Address                               Admin-Status
ce23/1             *1212:501:102:1::1                         [up/up]
                  fe80::ce37:abff:fec9:7426
```

```
RR#show int ce23/1
Interface ce23/1
Scope: both
Flexport: Breakout Control Port (Active): Break Out Enabled
Hardware is ETH Current HW addr: cc37.abc9.7426
Physical:cc37.abc9.743f Logical:(not set)
Port Mode is Router
Interface index: 10025
Metric 1 mtu 1500 duplex-full link-speed 1g
Bounce timer: disable
<UP,BROADCAST,RUNNING,MULTICAST>
VRF Binding: Not bound
DHCP client is disabled.
Last Flapped: 2021 Mar 02 09:44:05 (00:03:55 ago)
Statistics last cleared: 2021 Mar 02 09:44:05 (00:03:55 ago)
inet6 1212:501:102:1::1/64
inet6 fe80::ce37:abff:fec9:7426/64
ND router advertisements are sent approximately every 571 seconds
ND next router advertisement due in 434 seconds.
ND router advertisements live for 1800 seconds
Hosts use stateless autoconfig for addresses.
5 minute input rate 2 bits/sec, 0 packets/sec
5 minute output rate 23 bits/sec, 0 packets/sec
```

HOST

```
[root@localhost ~]#ifconfig -a
eth3      Link encap:Ethernet HWaddr 00:07:E9:A5:23:4C
inet6 addr: 1212:501:102:1:207:e9ff:fea5:234c/64 Scope:Global
inet6 addr: fe80::207:e9ff:fea5:234c/64 Scope:Link
```

```
UP BROADCAST RUNNING MULTICAST MTU:1500 Metric:1
RX packets:196985 errors:0 dropped:0 overruns:0 frame:0
TX packets:5733 errors:0 dropped:0 overruns:0 carrier:0
collisions:0 txqueuelen:1000
RX bytes:23542362 (22.4 MiB) TX bytes:710558 (693.9 KiB)
```

```
N4#show ipv6 interface xe7 brief
```

Interface	IPv6-Address	Admin-Status
ce23/1	*1212:501:102:1:6821:5fff:fe55:4a27 fe80::6a21:5fff:fe55:4a27	[up/up]

DHCP COMMAND REFERENCE

Dynamic Host Configuration Protocol Client	410
feature dhcp	411
ip address dhcp	412
ip dhcp client request	413
ipv6 address dhcp	414
ipv6 dhcp address-prefix-length	415
ipv6 dhcp client request	416
ipv6 dhcp client	418
show ipv6 dhcp vendor-opts	420
Dynamic Host Configuration Protocol Relay	421
clear ip dhcp relay option statistics	423
clear ipv6 dhcp pd-route (vrf NAME)	424
clear ip dhcp relay statistics	425
ip dhcp relay (configure mode)	426
ip dhcp relay (interface mode)	427
ip dhcp relay (L3VPN)	428
ip dhcp relay address	429
ip dhcp relay address global	430
ip dhcp relay information option	431
ip dhcp relay information option always-on	432
ip dhcp relay information source-ip	433
ip dhcp relay server-group	434
ip-dhcp-relay-server-select	435
ipv6 dhcp relay (configure mode)	436
ipv6 dhcp relay (interface mode)	437
ipv6 dhcp relay (L3VPN)	438
ipv6 dhcp relay address	439
ipv6 dhcp relay address global	440
ipv6 dhcp relay pd-route-injection	441
ipv6 dhcp relay server-group	442
ipv6 dhcp relay server-select	443
ipv6 dhcp relay subscriber-id	444
server A.B.C.D	445
server X:X::X:X	446
show ip dhcp relay	447
show ip dhcp relay address	448
show ip dhcp relay option statistics	449

show ip dhcp relay statistics	450
show ipv6 dhcp pd-route	451
show ipv6 dhcp relay	452
show ipv6 dhcp relay address	453
show running-config dhcp	454
DHCPv6 Prefix Delegation Commands	455
ipv6 address	456
ipv6 address autoconfig	457
ipv6 dhcp client max-delegated-prefixes	458
ipv6 dhcp prefix-delegation	459
show ipv6 dhcp interface	460
DHCP Server Commands	461
address range low-address A.B.C.D	462
address range low-address X:X::X:X	463
boot-file	464
dns-server A.B.C.D	465
dns-server X:X::X:X	466
domain-name	467
host-name	468
ip dhcp server (interface mode)	469
ip dhcp server default-lease-time	470
ip dhcp server max-lease-time	471
ip dhcp server pool	472
ipv6 dhcp server (interface mode)	473
ipv6 dhcp server pool	474
ipv6 dhcp server preference	475
ipv6 dhcp server rapid-commit	476
log-server	477
network A.B.C.D netmask	478
network X:X::X:X netmask	479
ntp-server A.B.C.D	480
ntp-server X:X::X:X	481
prefix high-range	482
routers A.B.C.D	483
temporary address X:X::X:X	484
tftp-server	485
vendor-options	486

Dynamic Host Configuration Protocol Client

This chapter describes the Dynamic Host Configuration Protocol (**DHCP**¹) client commands.

DHCP is used to configure devices that are connected to a network so they can communicate on that network using the Internet Protocol (IP). DHCP is implemented in a client-server model where DHCP clients request configuration data, such as an IP address, a default route, or DNS server addresses from a DHCP server.

This chapter contains these commands.

feature dhcp	411
ip address dhcp	412
ip dhcp client request	413
ipv6 address dhcp	414
ipv6 dhcp address-prefix-length	415
ipv6 dhcp client request	416
ipv6 dhcp client	418
show ipv6 dhcp vendor-opts	420

¹Dynamic Host Configuration Protocol

feature dhcp

Use this command to enable the **DHCP client**¹ and **DHCP**² relay on the device.

Use the **no** form of this command to disable the DHCP client and DHCP relay and delete any DHCP-related configuration.

Command Syntax

```
feature dhcp
no feature dhcp
```

Parameters

None

Default

By default, feature dhcp is disabled

Command Mode

Configure mode

Applicability

This command was introduced before OcNOS version 1.3.

Examples

```
#configure terminal
(config)#feature dhcp
```

¹A DHCP client is a hardware device or software that uses DHCP to get the network configuration information from a DHCP Server. VRF: VRF creates a logically isolated routing table within a single physical network device. Each VRF instance works as an independent routing instance that enables separate network traffic, maintains different routing tables, and provides network isolation.

²Dynamic Host Configuration Protocol

ip address dhcp

Use this command to get an IP address from a **DHCP**¹ server for this interface.

Use the **no** form of this command to disable the **DHCP client**² for this interface.

Configure the command [ip dhcp client request \(page 413\)](#) before configuring the [ip address dhcp \(page 412\)](#) command to request additional options.

Command Syntax

```
ip address dhcp
no ip address dhcp
```

Parameters

None

Default

None

Command Mode

Interface mode

Applicability

This command was introduced before OcNOS version 1.3.

Examples

```
#configure terminal
(config)#interface eth0
(config-if)#ip address dhcp
(config-if)#
```

¹Dynamic Host Configuration Protocol

²A DHCP client is a hardware device or software that uses DHCP to get the network configuration information from a DHCP Server. VRF: VRF creates a logically isolated routing table within a single physical network device. Each VRF instance works as an independent routing instance that enables separate network traffic, maintains different routing tables, and provides network isolation.

ip dhcp client request

Use this command to add an option to a **DHCP**¹ request.

Use the **no** form of this command to remove an option from a DHCP request.

Command Syntax

```
ip dhcp client request dns-nameserver
ip dhcp client request host-name
ip dhcp client request log-server
ip dhcp client request ntp-server
no ip dhcp client request dns-nameserver
no ip dhcp client request host-name
no ip dhcp client request log-server
no ip dhcp client request ntp-server
```

Parameters

dns-nameserver

List of DNS name servers (DHCP option 6)

host-name

Name of the client (DHCP option 12)

ntp-server

List of NTP servers (DHCP option 42)

log-server

List of log servers (DHCP option 7)

Default

By default, ip dhcp client request is enabled

Command Mode

Interface mode

Applicability

This command was introduced before OcNOS version 1.3.

Examples

```
#configure terminal
(config)#interface eth0
(config-if)#ip dhcp client request ntp-server
```

¹Dynamic Host Configuration Protocol

ipv6 address dhcp

Use this command to get an IPV6 address from a **DHCP**¹ server for this interface.

Use the **no** form of this command to disable the **DHCP client**² for this interface.

You can give the `ipv6 dhcp client request` command before giving this command to request additional options.

Command Syntax

```
ipv6 address dhcp
no ipv6 address dhcp
```

Parameters

None

Default

None

Command Mode

Interface mode

Applicability

This command was introduced before OcNOS version 1.3.

Examples

```
#configure terminal
(config)#interface eth0
(config-if)#ipv6 address dhcp
(config-if)#
```

¹Dynamic Host Configuration Protocol

²A DHCP client is a hardware device or software that uses DHCP to get the network configuration information from a DHCP Server. VRF: VRF creates a logically isolated routing table within a single physical network device. Each VRF instance works as an independent routing instance that enables separate network traffic, maintains different routing tables, and provides network isolation.

ipv6 dhcp address-prefix-length

Use this command to configure the prefix-length for dynamically allocated IPv6 address.

Use the `no` form of this command to unconfigure the prefix-length.

Command Syntax

```
ipv6 dhcp address-prefix-length <1-128>  
no ipv6 dhcp address-prefix-length
```

Parameters

<1-128>

IPv6 address prefix length

Default

Default ipv6 address prefix length is 128

Command Mode

Interface mode

Applicability

This command was introduced before OcNOS version 1.3.

Examples

```
#configure terminal  
(config)#interface xe1  
(config-if)#ipv6 dhcp address-prefix-length 64  
(config-if)
```

ipv6 dhcp client request

Use this command to add an option to a DHCPv6 request.

Use the `no` form of this command to remove an option from a DHCPv6 request.



Notes:

- Vendor-specific options allow a specific vendor to define a set of **DHCP**¹ options that really make sense for their device or operating system.
- By default DHCPv6 uses four messages exchange (Solicit, Advertise, Request, and Reply) to obtain configuration parameters from a server. But when rapid-commit is specified, **dhcp6-client** will include a rapid-commit option in solicit messages and wait for an immediate reply instead of advertisements. The Rapid Commit option is used to signal the use of the two message exchange for address assignment.

Command Syntax

```
ipv6 dhcp client request dns-nameserver
ipv6 dhcp client request ntp-server
ipv6 dhcp client request domain-search
ipv6 dhcp client request vendor-specific-information
ipv6 dhcp client request rapid-commit
no ipv6 dhcp client request rapid-commit
no ipv6 dhcp client request vendor-specific-information
no ipv6 dhcp client request domain-search
no ipv6 dhcp client request ntp-server
no ipv6 dhcp client request dns-nameserver
```

Parameters

dns-nameserver

List of DNS name servers

ntp-server

Request for IPv6 NTP server

domain-search

Request for IPv6 domain search

vendor-specific-information

Request for IPv6 vendor-specific-information

rapid-commit

Request to enable rapid-commit

Default

None

Command Mode

Interface mode

¹Dynamic Host Configuration Protocol

Applicability

This command was introduced before OcNOS version 1.3 and modified in OcNOS version 5.0

Examples

```
#configure terminal
(config)#interface eth0
(config-if)#ipv6 dhcp client request dns-nameserver
(config-if)#

(config)#interface eth0
(config-if)#ipv6 dhcp client request ntp-server
(config-if)#exit

(config)#interface eth0
(config-if)#ipv6 dhcp client request domain-search
(config-if)#exit

(config)#interface eth0
(config-if)#ipv6 dhcp client request vendor-specific-information
(config-if)#exit

(config)#interface eth0
(config-if)#ipv6 dhcp client request rapid-commit
(config-if)#exit
```

ipv6 dhcp client

Use this command to configure **DHCP client**¹ options to a DHCPv6 request.

Use the **no** form of this command to remove client options from a DHCPv6 request.



Notes:

- The command **ipv6 dhcp client information-request** is used to get only stateless configuration parameters (i.e., without address).
- DAD-wait-time value is the maximum time (in seconds) that the client should wait for the duplicate address detection (DAD) to complete on an interface.
- DUID option override the default when selecting the type of DUID to use. By default, DHCPv6 dhclient creates an identifier based on the link-layer address (DUID-LL) if it is running in stateless mode (with -S, not requesting an address), or it creates an identifier based on the link-layer address plus a timestamp (DUID-LLT) if it is running in stateful mode (without -S, requesting an address).

Command Syntax

```
ipv6 dhcp client information-request
ipv6 dhcp client dad-wait-time <1-600>
ipv6 dhcp client duid (ll | llt)
no ipv6 dhcp client duid
no ipv6 dhcp client dad-wait-time
no ipv6 dhcp client information-request
```

Parameters

information-request

Request to enable information-request

<1-600>

DAD wait-time in seconds

duid ll

Link-layer address

duid llt

Link-layer address plus timestamp

Default

None

Command Mode

Interface mode

¹A DHCP client is a hardware device or software that uses DHCP to get the network configuration information from a DHCP Server. VRF: VRF creates a logically isolated routing table within a single physical network device. Each VRF instance works as an independent routing instance that enables separate network traffic, maintains different routing tables, and provides network isolation.

Applicability

This command was introduced before OcNOS version 1.3 and modified in OcNOS version 5.0

Examples

```
#configure terminal
(config)#interface eth0
(config-if)#ipv6 dhcp client information-request
(config-if)#exit

(config)#interface eth0
(config-if)#ipv6 dhcp client dad-wait-time 20
(config-if)#exit

(config)#interface eth0
(config-if)#ipv6 dhcp client duid ll
(config-if)#exit
```

show ipv6 dhcp vendor-opts

Use this command to display vendor-specific-information option value given by **DHCP**¹ server.

Command Syntax

```
show ipv6 dhcp vendor-opts
```

Parameters

None

Command Mode

Execution mode

Applicability

This command is introduced in OcNOS version 5.0

Examples

```
#show ipv6 dhcp vendor-opts
ifName          vendor-opts
=====
xe5             IP Infusion Inc
```

¹Dynamic Host Configuration Protocol

Dynamic Host Configuration Protocol Relay

This chapter describes the Dynamic Host Configuration Protocol (**DHCP**¹) relay commands.

In small networks with only one IP subnet, DHCP clients communicate directly with DHCP servers. When DHCP clients and associated servers do not reside on the same subnet, a **DHCP relay agent**² can be used to forward **DHCP client**³ messages to DHCP server.

The DHCP client broadcasts on the local link, the relay agents receives the broadcast DHCP messages, and then generate a new DHCP message to send out on another interface.

The relay agent sets the gateway IP address (**giaddr** field of the DHCP packet) and, if configured, adds the relay agent information option (option 82) in the packet and forwards it to the DHCP server. The DHCP server replies to the client and the relay agent then retransmits the response on the local network.

This chapter contains these commands:

clear ip dhcp relay option statistics	423
clear ipv6 dhcp pd-route (vrf NAME)	424
clear ip dhcp relay statistics	425
ip dhcp relay (configure mode)	426
ip dhcp relay (interface mode)	427
ip dhcp relay (L3VPN)	428
ip dhcp relay address	429
ip dhcp relay address global	430
ip dhcp relay information option	431
ip dhcp relay information option always-on	432
ip dhcp relay information source-ip	433
ip dhcp relay server-group	434
ip-dhcp-relay-server-select	435
ipv6 dhcp relay (configure mode)	436
ipv6 dhcp relay (interface mode)	437
ipv6 dhcp relay (L3VPN)	438
ipv6 dhcp relay address	439
ipv6 dhcp relay address global	440
ipv6 dhcp relay pd-route-injection	441
ipv6 dhcp relay server-group	442
ipv6 dhcp relay server-select	443
ipv6 dhcp relay subscriber-id	444

¹Dynamic Host Configuration Protocol

²A DHCP relay forwards the request from a DHCP client to the DHCP server group and takes the response from the DHCP server group to the DHCP client.

³A DHCP client is a hardware device or software that uses DHCP to get the network configuration information from a DHCP Server. VRF: VRF creates a logically isolated routing table within a single physical network device. Each VRF instance works as an independent routing instance that enables separate network traffic, maintains different routing tables, and provides network isolation.

server A.B.C.D	445
server X:X::X:X	446
show ip dhcp relay	447
show ip dhcp relay address	448
show ip dhcp relay option statistics	449
show ip dhcp relay statistics	450
show ipv6 dhcp pd-route	451
show ipv6 dhcp relay	452
show ipv6 dhcp relay address	453
show running-config dhcp	454

clear ip dhcp relay option statistics

Use this command to clear ipv4 relay option statistics.

Command Syntax

```
clear ip dhcp relay option statistics
```

Parameters

None

Command Mode

Execution mode

Applicability

This command was introduced in OcNOS version 1.3.9.

Examples

```
#clear ip dhcp relay option statistics
```

clear ipv6 dhcp pd-route (|vrf NAME)

Use this command to clear the routes in RIBD module learnt as part of Route injection feature.

Command Syntax

```
clear ipv6 dhcp pd-route (|vrf NAME)
```

Parameters

NAME

Name of the VRF¹

Default

None

Command Mode

Execution mode

Applicability

This command was introduced in OcNOS version 4.2.

Examples

```
#clear ipv6 dhcp pd-route vrf vrf1
```

¹Virtual Routing and Forwarding

clear ip dhcp relay statistics

Use this command to clear ipv4 relay statistics.

Command Syntax

```
clear ip dhcp relay statistics
```

Parameters

None

Command Mode

Execution mode

Applicability

This command was introduced in OcNOS version 1.3.9.

Examples

```
#clear ip dhcp relay statistics
```

ip dhcp relay (configure mode)

Use this command to enable the **DHCP relay agent**¹. The **DHCP**² relay starts forwarding packets to the DHCP server address once configured.

Use the **no** form of this command to disable the DHCP relay agent.

Command Syntax

```
ip dhcp relay
no ip dhcp relay
```

Parameters

None

Default

By default, this feature is enabled.

Command Mode

Configure mode

Applicability

This command was introduced before OcNOS version 1.3.

Examples

```
#configure terminal
(config)#ip dhcp relay

#configure terminal
(config)#no ip dhcp relay
```

¹A DHCP relay forwards the request from a DHCP client to the DHCP server group and takes the response from the DHCP server group to the DHCP client.

²Dynamic Host Configuration Protocol

ip dhcp relay (interface mode)

Use this command to configure an interface as a **DHCP client**¹-facing port.

Use the **no** form of this command to remove an interface as a **DHCP**² client-facing port.

Command Syntax

```
ip dhcp relay
no ip dhcp relay
```

Parameters

None

Default

No default value is specified.

Command Mode

Interface mode

Applicability

This command was introduced in OcNOS version 1.3.8.

Examples

```
#configure terminal
(config)#interface eth2
(config-if)#ip dhcp relay
```

¹A DHCP client is a hardware device or software that uses DHCP to get the network configuration information from a DHCP Server. VRF: VRF creates a logically isolated routing table within a single physical network device. Each VRF instance works as an independent routing instance that enables separate network traffic, maintains different routing tables, and provides network isolation.

²Dynamic Host Configuration Protocol

ip dhcp relay (L3VPN)

Use this command to specify IPv4 **DHCP**¹ relay to use tunnel interfaces as Uplink/Downlink.

Use the **no** form of this command to remove the usage of tunnel interfaces in IPv4 DHCP relay.

Command Syntax

```
ip dhcp relay (uplink|downlink) (l3vpn)
no ip dhcp relay (uplink|downlink) (l3vpn)
```

Parameters

uplink

DHCP Relay uplink interface

downlink

DHCP Relay downlink interface

l3vpn

L3VPN interface

Default

None

Command Mode

Configure mode and **VRF**² mode

Applicability

This command was introduced in OcNOS version 5.0.

Examples

```
#configure terminal
(config)#ip vrf vrf1
(config-vrf)#ip dhcp relay uplink l3vpn
(config-vrf)#end

#configure terminal
(config)#ip dhcp relay uplink l3vpn
```

¹Dynamic Host Configuration Protocol

²Virtual Routing and Forwarding

ip dhcp relay address

Use this command to set an IPv4 address of a **DHCP**¹ server to which a **DHCP relay agent**² forwards client requests.

Use the **no** form of this command to remove the IP address of a DHCP server.

User must enable the DHCP relay feature with the [ip dhcp relay \(configure mode\) \(page 426\)](#) command to configure server address.

Command Syntax

```
ip dhcp relay address A.B.C.D
no ip dhcp relay address A.B.C.D
```

Parameters

A.B.C.D

IPv4 address of the DHCP server

Default

None

Command Mode

Configure mode

VRF³ mode

Applicability

This command was introduced before OcNOS version 1.3 and was changed in OcNOS version 1.3.8.

Examples

```
#configure terminal
(config)#ip vrf vrf1
(config-vrf)#ip dhcp relay address 198.51.100.127

#configure terminal
(config)#ip dhcp relay address 198.51.100.127
```

¹Dynamic Host Configuration Protocol

²A DHCP relay forwards the request from a DHCP client to the DHCP server group and takes the response from the DHCP server group to the DHCP client.

³Virtual Routing and Forwarding

ip dhcp relay address global

When the IPv4 **DHCP**¹ server resides in a different VPN or global space that is different from the VPN, then use this command to specify the name of the **VRF**² or global space in which the DHCP server resides.

Use the no form of this command to remove the VRF in which IPv4 DHCP server resides.

Command Syntax

```
ip dhcp relay address A.B.C.D global (|VRF-NAME)
no ip dhcp relay address A.B.C.D global
```

Parameters

A.B.C.D

IPv4 address of the DHCP server

VRF-NAME

Name of VRF where the DHCP server is present

Default

If no input given, default VRF is the default Value.

Command Mode

Configure mode and VRF mode

Applicability

This command was introduced in OcNOS version 5.1.

Examples

```
#configure terminal
(config)#ip vrf vrf1
(config-vrf)#ip dhcp relay address 198.51.100.127 global

#configure terminal
(config)#ip dhcp relay address 198.51.100.127 global vrf1
```

¹Dynamic Host Configuration Protocol

²Virtual Routing and Forwarding

ip dhcp relay information option

Use this command to enable the device to insert and remove option 82 information in **DHCP**¹ packets forwarded by the relay agent.

The option 82 suboption remote-id can be configured either as hostname or any string provided by the User.

Use the **no** form of this command to disable inserting and removing option-82 information.

Command Syntax

```
ip dhcp relay information option (|remote-id (hostname|WORD))
no ip dhcp relay information option (|remote-id)
```

Parameters

remote-id

Remote host Identifier, can either be the System's hostname or a user-specified string.

WORD

Specify a string as remote-id (Maximum 255 alphanumeric characters).

Default

None

Command Mode

Configure mode and **VRF**² mode

Applicability

This command was introduced before OcNOS version 1.3 and was changed in OcNOS version 1.3.8.

Examples

```
#configure terminal
(config)#ip vrf vrf1
(config-vrf)#ip dhcp relay information option remote-id hostname

#configure terminal
(config)#ip dhcp relay information option

#configure terminal
(config)#no ip dhcp relay information option
```

¹Dynamic Host Configuration Protocol

²Virtual Routing and Forwarding

ip dhcp relay information option always-on

Use this command to enable the device to insert options 82 information in **DHCP**¹ packets forwarded by the relay-agent and keep them while forwarding to client.

Use the **no** form of this command to disable the option-82 always-on information.

Command Syntax

```
ip dhcp relay information option always-on
no ip dhcp relay information option always-on
```

Parameters

None

Default

None

Command Mode

Configure mode

VRF² mode

Applicability

This command was introduced before OcNOS version 1.3 and was changed in OcNOS version 6.2.0.

Examples

```
#configure terminal
(config)#ip vrf vrf1
(config-vrf)#ip dhcp relay information option always-on

#configure terminal
(config)#ip dhcp relay information option always-on

#configure terminal
(config)#no ip dhcp relay information option always-on
```

¹Dynamic Host Configuration Protocol

²Virtual Routing and Forwarding

ip dhcp relay information source-ip

Use this command to enable **DHCP**¹ relay option 82 link selection.

Use the no form of this command to disable DHCP relay option 82 link selection.

Command Syntax

```
ip dhcp relay information source-ip A.B.C.D
no ip dhcp relay information source-ip
```

Parameters

A.B.C.D

IPv4 address

Default

None

Command Mode

Configure mode and **VRF**² mode

Applicability

This command was introduced before OcNOS version 1.3.6.

Example

```
#configure terminal
(config)#ip vrf vrf1
(config-vrf)#ip dhcp relay information option source-ip 2.2.2.2

#configure terminal
(config)#ip dhcp relay information option source-ip 3.3.3.3
```

¹Dynamic Host Configuration Protocol

²Virtual Routing and Forwarding

ip dhcp relay server-group

Use this command to create the **DHCP**¹ IPv4 server group. This group lists the servers to which DHCP Relay forwards the **DHCP client**² requests.

Use the **no** form of this command to unconfigure the DHCP IPv4 server group.

Command Syntax

```
ip dhcp relay server-group GROUP_NAME
no ip dhcp relay server-group GROUP_NAME
```

Parameters

GROUP_NAME

Name of the DHCP server group (specify a maximum 63 alphanumeric characters).

Command Mode

Configure mode and **VRF**³ mode. In the configure mode, the DHCP IPv4 server group is created in the default VRF. In the configure-vrf mode, the DHCP IPv4 server group is created in the user-defined VRF.

Applicability

This command was introduced in OcNOS version 6.4.1.

Examples

The example below shows the creation of DHCP IPv4 server groups.

```
OcNOS(config)#ip vrf vrf1
OcNOS(config-vrf)#ip dhcp relay server-group Group1
OcNOS(dhcp-relay-group)#end
OcNOS#configure terminal
OcNOS(config)#ip dhcp relay server-group Group2
```

¹Dynamic Host Configuration Protocol

²A DHCP client is a hardware device or software that uses DHCP to get the network configuration information from a DHCP Server. VRF: VRF creates a logically isolated routing table within a single physical network device. Each VRF instance works as an independent routing instance that enables separate network traffic, maintains different routing tables, and provides network isolation.

³Virtual Routing and Forwarding

ip-dhcp-relay-server-select

Use this command to attach the **DHCP**¹ IPv4 server group to the DHCP relay uplink interface.

DHCP Server Group

Use the no form of this command to remove the DHCP IPv4 server group attached to the DHCP relay interface.



Note: Attach the groups only to the DHCP relay uplink interfaces.

Command Syntax

```
ip dhcp relay server-select GROUP_NAME
no ip dhcp relay server-select
```

Parameters

GROUP_NAME

Name of the DHCP server group (specify a maximum 63 alphanumeric characters).

Command Mode

Interface mode

Applicability

This command was introduced in OcNOS version 6.4.1

Examples

The below example shows attaching the DHCP IPv4 server group to the DHCP relay uplink interface:

```
OcNOS#configure terminal
OcNOS(config)#interface xe1
OcNOS(config-if)#ip dhcp relay server-select group1
```

¹Dynamic Host Configuration Protocol

ipv6 dhcp relay (configure mode)

Use this command to enable the **DHCP**¹ IPv6 relay agent.

Use the **no** form of this command to disable the DHCP IPv6 relay agent.

Command Syntax

```
ipv6 dhcp relay
no ipv6 dhcp relay
```

Parameters

None

Default

None

Command Mode

Configure mode

Applicability

This command was introduced before OcNOS version 1.3.

Examples

```
#configure terminal
(config)#ipv6 dhcp relay

#configure terminal
(config)#no ipv6 dhcp relay
```

¹Dynamic Host Configuration Protocol

ipv6 dhcp relay (interface mode)

Use this command to configure an interface as a DHCPv6 client-facing port.

Use the `no` form of this command to remove an interface as a DHCPv6 client-facing port.

Command Syntax

```
ipv6 dhcp relay
no ipv6 dhcp relay
```

Parameters

None

Default

None

Command Mode

Interface mode

Applicability

This command was introduced in OcNOS version 1.3.8.

Examples

```
#configure terminal
(config)#interface eth1
(config-if)#ipv6 dhcp relay
```

ipv6 dhcp relay (L3VPN)

Use this command to specify IPv6 **DHCP**¹ relay to use tunnel interfaces as Uplink/Downlink.

Use the **no** form of this command to remove the usage of tunnel interfaces in IPv6 DHCP relay.

Command Syntax

```
ipv6 dhcp relay (uplink|downlink) (l3vpn)
no ipv6 dhcp relay (uplink|downlink) (l3vpn)
```

Parameters

uplink

DHCP Relay uplink interface

downlink

DHCP Relay downlink interface

l3vpn

L3VPN interface

Default

None

Command Mode

Configure mode and **VRF**² mode

Applicability

This command was introduced in OcNOS version 5.0.

Examples

```
#configure terminal
(config)#ip vrf vrf1
(config-vrf)#ipv6 dhcp relay uplink l3vpn
(config-vrf)#end

#configure terminal
(config)#ipv6 dhcp relay uplink l3vpn
```

¹Dynamic Host Configuration Protocol

²Virtual Routing and Forwarding

ipv6 dhcp relay address

Use this command to set an IPv6 address of a **DHCP**¹ server to which a **DHCP relay agent**² forwards client requests.

Use the **no** form of this command to remove an IPv6 address of a DHCP server.

User must enable the IPv6 DHCP relay feature with the [ipv6 dhcp relay \(configure mode\) \(page 436\)](#) command to configure server address.

Command Syntax

```
ipv6 dhcp relay address X:X::X:X
no ipv6 dhcp relay address X:X::X:X
```

Parameters

X:X::X:X

IPv6 address of the DHCP server

Default

None

Command Mode

Configure mode

VRF³ mode

Applicability

This command was introduced before OcNOS version 1.3 and was changed in OcNOS version 1.3.8.

Examples

```
#configure terminal
(config)#ip vrf vrf1
(config-vrf)#ipv6 dhcp relay address 2001:db8::7F

#configure terminal
(config)#ipv6 dhcp relay address 2001:db8::7F
```

¹Dynamic Host Configuration Protocol

²A DHCP relay forwards the request from a DHCP client to the DHCP server group and takes the response from the DHCP server group to the DHCP client.

³Virtual Routing and Forwarding

ipv6 dhcp relay address global

When the IPv6 **DHCP**¹ server resides in a different VPN or global space that is different from the VPN, then use this command to specify the name of the **VRF**² or global space in which the DHCP server resides.

Use the no form of this command to remove the VRF in which IPv6 DHCP server resides.

Command Syntax

```
ipv6 dhcp relay address X:X::X:X global (|VRF-NAME)
no ipv6 dhcp relay address X:X::X:X global
```

Parameters

X:X::X:X

IPv6 address of the DHCP server

VRF-NAME

Name of VRF where the DHCP server is present

Default

If no input given, default VRF is the default Value.

Command Mode

Configure mode and VRF mode

Applicability

This command was introduced in OcNOS version 5.1.

Examples

```
#configure terminal
(config)#ip vrf vrf1
(config-vrf)#ipv6 dhcp relay address 2001:db8::7F global

#configure terminal
(config)#ipv6 dhcp relay address 2001:db8::7F global vrf1
```

¹Dynamic Host Configuration Protocol

²Virtual Routing and Forwarding

ipv6 dhcp relay pd-route-injection

Use this command to enable the Route Injection of the delegated prefixes in **DHCP**¹ Relay.

Use the no form of this command to disable Route Injection.

Command Syntax

```
ipv6 dhcp relay pd-route-injection
no ipv6 dhcp relay pd-route-injection
```

Parameters

None

Default

By default this feature is disabled.

Command Mode

Configure mode

VRF² mode

Applicability

This command was introduced in OcNOS version 4.2.

Examples

```
#configure terminal
(config)# ip vrf vrf1
(config-vrf)# ipv6 dhcp relay pd-route-injection

#configure terminal
(config)#ipv6 dhcp relay pd-route-injection
```

¹Dynamic Host Configuration Protocol

²Virtual Routing and Forwarding

ipv6 dhcp relay server-group

Use this command to create the **DHCP**¹ IPv6 server group. This group lists the servers to which DHCP relay forwards the **DHCP client**² requests.

Use the no form of this command to unconfigure the DHCP IPv6 server group.

Command Syntax

```
ipv6 dhcp relay server-group GROUP_NAME
no ipv6 dhcp relay server-group GROUP_NAME
```

Parameters

GROUP_NAME

Name of the DHCP server group (specify a maximum of 63 alphanumeric characters).

Command Mode

Configure mode and **VRF**³ mode. In the configure mode, the DHCP IPv6 server group is created in the default VRF. In the configure-vrf mode, the DHCP IPv6 server group is created in the user-defined VRF.

Applicability

This command was introduced in OcNOS version 6.4.1.

Examples

The example below shows the creation of DHCP IPv6 server groups:

```
OcNOS#configure terminal
OcNOS(config)#ip vrf vrf1
OcNOS(config-vrf)#ipv6 dhcp relay server-group Group1
OcNOS(dhcp relay server-group)#end
OcNOS#configure terminal
OcNOS(config)#ipv6 dhcp relay server-group Group2
```

¹Dynamic Host Configuration Protocol

²A DHCP client is a hardware device or software that uses DHCP to get the network configuration information from a DHCP Server. VRF: VRF creates a logically isolated routing table within a single physical network device. Each VRF instance works as an independent routing instance that enables separate network traffic, maintains different routing tables, and provides network isolation.

³Virtual Routing and Forwarding

ipv6 dhcp relay server-select

Use this command to attach the **DHCP**¹ IPv6 group to the DHCP relay uplink interface.

Use the **no** form of this command to remove the DHCP IPv6 group attached to the interface.



Note: Attach the groups only to the DHCP relay uplink interfaces.

Command Syntax

```
ipv6 dhcp relay server-select GROUP_NAME
no ipv6 dhcp relay server-select
```

Parameters

GROUP_NAME

Name of the DHCP server group (specify a maximum of 63 alphanumeric characters).

Command Mode

Interface mode

Applicability

This command was introduced in OcNOS version 6.4.1.

Examples

The below example shows how to attach the DHCP IPv6 server group to the DHCP relay uplink interface:

```
#configure terminal
(config)#interface xe1
(config-if)#ipv6 dhcp relay server-select group1
```

¹Dynamic Host Configuration Protocol

ipv6 dhcp relay subscriber-id

Use this command to configure subscriber-ID for IPv6 **DHCP**¹ relay.

Use **no** form of this command to disable subscriber-id.

Command Syntax

```
ipv6 dhcp relay information option subscriber-id WORD
no ipv6 dhcp relay information option subscriber-id
```

Parameters

WORD

Subscriber ID

Default

None

Command Mode

Configure mode and **VRF**² mode

Applicability

This command is introduced in OcNOS version 5.0

Examples

```
#configure terminal
(config)#ipv6 dhcp relay information option subscriber-id test
(config)#exit
```

¹Dynamic Host Configuration Protocol

²Virtual Routing and Forwarding

server A.B.C.D

Use this command to add the **DHCP**¹ IPv4 servers to the DHCP server group.

Use the **no** form of this command to remove the DHCP IPv4 servers from the DHCP server Group.



Note: A maximum of eight servers can be added to a DHCP group.

Command Syntax

```
server A.B.C.D
no server A.B.C.D
```

Parameters

A.B.C.D

DHCP IPv4 Relay group server address to be added in the DHCP server group.

Command Mode

DHCP Relay Group Mode.

Applicability

This command was introduced in OcNOS version 6.4.1.

Examples

The below example shows the addition of DHCP IPv4 servers to a DHCP server group:

```
OcNOS#configure terminal
OcNOS(config)#ip vrf vrf1
OcNOS(config-vrf)#ip dhcp relay server-group group
OcNOS(dhcp-relay-group)#server 10.12.23.205
OcNOS(dhcp-relay-group)#end
OcNOS#configure terminal
OcNOS(config)#ip dhcp relay server-group group1
OcNOS(dhcp-relay-group)#server 10.12.33.204
```

¹Dynamic Host Configuration Protocol

server X:X::X:X

Use this command to add the **DHCP**¹ IPv6 servers to the DHCP server group.

Use the **no** form of this command to remove the DHCP IPv6 servers from the DHCP server group.



Note: A maximum of eight servers can be added to a DHCP group.

Command Syntax

```
server X:X::X:X
no server X:X::X:X
```

Parameters

X:X::X:X

DHCP IPv6 Relay Group server address to be added in the DHCP server group.

Command Mode

DHCP Relay Group Mode

Applicability

This command was introduced in OcNOS version 6.4.1.

Examples

The below example shows the addition of DHCP IPv6 servers to a DHCP server group:

```
OcNOS#configure terminal
OcNOS(config)#ip vrf vrf1
OcNOS(config-vrf)#ipv6 dhcp relay server-group group
OcNOS(dhcp6-relay-group)#server 2003::1
OcNOS(dhcp6-relay-group)#end

OcNOS#configure terminal
OcNOS(config)#ipv6 dhcp relay server-group group1
OcNOS(dhcp-relay-group)#server 2001::1
OcNOS(dhcp6-relay-group)end
```

¹Dynamic Host Configuration Protocol

show ip dhcp relay

Use this command to display **DHCP**¹ relay status including DHCP server addresses configured on interfaces.

Command Syntax

```
show ip dhcp relay
```

Parameters

None

Command Mode

Execution mode

Applicability

This command was introduced before OcNOS version 1.3 and changed in OcNOS version 1.3.8.

Examples

```
#show ip dhcp relay
DHCP relay service is Enabled.
VRF Name: vrf1
  Option 82: Enabled
  Remote Id: ocnos-device
  Link selection Source-IP: 1.4.5.6
  DHCP Servers configured: 9.9.9.9 8.8.8.8
  Interface                Uplink/Downlink
  -----
  ge10                      Uplink
  ge28                      Downlink
VRF Name: default
  Option 82: Enabled
  Remote Id: OcNOS
  Link selection Source-IP: 1.2.3.4
  DHCP Servers configured: 1.1.1.1 2.2.2.2
  Interface                Uplink/Downlink
  -----
  ge11                      Uplink
  ge27                      Downlink
```

¹Dynamic Host Configuration Protocol

show ip dhcp relay address

Use this command to display **DHCP**¹ relay addresses.

Command Syntax

```
show ip dhcp relay address
```

Parameters

None

Command Mode

Execution mode

Applicability

This command was introduced before OcNOS version 1.3 and changed in OcNOS version 1.3.8.

Examples

```
#show ip dhcp relay address
VRF Name: vrf1
  DHCP Servers configured: 9.9.9.9 8.8.8.8
VRF Name: default
  DHCP Servers configured: 1.1.1.1 2.2.2.2
```

¹Dynamic Host Configuration Protocol

show ip dhcp relay option statistics

Use this command to display IPv4 **DHCP**¹ Relay Agent Option(Option82) packet statistics

Command Syntax

```
show ip dhcp relay option statistics
```

Parameters

None

Command Mode

Execution mode

Applicability

This command was introduced in OcNOS version 1.3.9.

Examples

```
#sh ip dhcp relay option statistics
VRF Name: default
Remote ID : OcNOS
Circuit ID : ge5
Number of packets forwarded without agent options : 0
Dropped pkts due to bad relay agent information option : 0
Dropped pkts due to no RAI option match found : 0
Circuit ID option is not matching with known circuit ID : 0
Circuit ID option in matching RAI option was missing : 0
#
```

¹Dynamic Host Configuration Protocol

show ip dhcp relay statistics

Use this command to display IPv4 **DHCP**¹ relayed packet statistics.



Note: DHCPv6 relay statistics is not supported

Command Syntax

```
show ip dhcp relay statistics
```

Parameters

None

Command Mode

Execution mode

Applicability

This command was introduced in OcNOS version 1.3.9.

Examples

```
#sh ip dhcp relay statistics
VRF Name: default
Packets sent with a bogus giaddr : 0
Packets relayed from client to server : 12
Errors sending packets to servers : 0
Packets relayed from server to client : 1
Errors sending packets to clients : 0
#
```

¹Dynamic Host Configuration Protocol

show ipv6 dhcp pd-route

Use this command to display the routes and their properties installed as part of the Route Injection feature

Command Syntax

```
show ipv6 dhcp pd-route
```

Parameters

None

Command Mode

Execution mode

Applicability

This command was introduced in OcNOS version 4.2.

Examples

```
#show ipv6 dhcp pd-route  
VRF : vrf1  
4002:db8:1bff::/48 via xe9 (2019-02-14 10:50:18 - 2019-02-14 10:51:58)
```

show ipv6 dhcp relay

Use this command to display **DHCP**¹ IPv6 relay status including DHCP IPv6 server addresses configured on interfaces.

Command Syntax

```
show ipv6 dhcp relay
```

Parameters

None

Command Mode

Execution mode

Applicability

This command was introduced before OcNOS version 1.3 and changed in OcNOS version 1.3.8.

Examples

```
#show ipv6 dhcp relay
IPv6 DHCP relay service is Enabled.
VRF Name: vrf1
  DHCPv6 Servers configured: 2001::1
  Interface                  Uplink/Downlink
  -----
  ge35                       Uplink
  xe50                       Downlink
VRF Name: default
  DHCPv6 Servers configured: 3001::1
  Interface                  Uplink/Downlink
  -----
  ge34                       Uplink
  xe49                       Downlink
```

¹Dynamic Host Configuration Protocol

show ipv6 dhcp relay address

Use this command to display **DHCP**¹ IPv6 relay addresses.

Command Syntax

```
show ipv6 dhcp relay address
```

Parameters

None

Command Mode

Execution mode

Applicability

This command was introduced before OcNOS version 1.3 and changed in OcNOS version 1.3.8.

Examples

```
#show ipv6 dhcp relay address
VRF Name: vrf1
  DHCPv6 Servers configured: 2001::1
VRF Name: default
  DHCPv6 Servers configured: 3001::1
```

¹Dynamic Host Configuration Protocol

show running-config dhcp

Use this command to display **DHCP**¹ settings in the running configuration.

Command Syntax

```
show running-config dhcp
```

Parameters

None

Command Mode

Execution mode

Applicability

This command was introduced before OcNOS version 1.3 and changed in OcNOS version 1.3.8.

Examples

```
#show running-config dhcp
ip vrf vrf1
 ip dhcp relay information option remote-id hostname
 ip dhcp relay address 1.1.1.2

ip dhcp relay information option remote-id hostname
ip dhcp relay information source-ip 5.4.3.2
ip dhcp relay address 1.1.1.1
```

¹Dynamic Host Configuration Protocol

DHCPv6 Prefix Delegation Commands

This chapter describes the Dynamic Host Configuration Protocol (**DHCP**¹) v6 Prefix delegation commands.

The prefix delegation feature lets a DHCP server assign prefixes chosen from a global pool to DHCP clients. The **DHCP client**² can configure an IPv6 address on its LAN interface using the prefix it received. Then it send router advertisements including the prefix, allowing other devices to auto configure their own IPv6 addresses.

Enable OcNOS device DHCP Client to receive the prefixes from external DHCP Server and enable IPv6 address autoconfiguration of LAN interfaces and the respective host machines.

This feature enables the service providers to assign IP for the Customer Premise Equipment acting as a router between the service providers core network and subscribers internal network.

This chapter contains these commands:

ipv6 address	456
ipv6 address autoconfig	457
ipv6 dhcp client max-delegated-prefixes	458
ipv6 dhcp prefix-delegation	459
show ipv6 dhcp interface	460

¹Dynamic Host Configuration Protocol

²A DHCP client is a hardware device or software that uses DHCP to get the network configuration information from a DHCP Server. VRF: VRF creates a logically isolated routing table within a single physical network device. Each VRF instance works as an independent routing instance that enables separate network traffic, maintains different routing tables, and provides network isolation.

ipv6 address

Use this command to configure the global IPv6 address using the learned prefix and user provided suffix.

Use the `no` form of this command to remove the configuration.

Command Syntax

```
ipv6 address PREFIX-NAME X:X::X:X/M
no ipv6 address PREFIX-NAME X:X::X:X/M
```

Parameters

PREFIX-NAME

Name of the prefix which stores the address-prefix learnt using prefix delegation enabled in the client interface

X:X::X:X/M

Suffix address consists subnet id and host address. This value must start with '::', and end with a /64 bit prefix.

Default

DHCPv6 IA_PD option is not requested by default.

Command Mode

Interface mode

Applicability

This command was introduced in OcNOS version 4.2.OcNOS version 1.3.9

Examples

```
#configure terminal
(config)#interface xe1
(config-if)#ipv6 address dhcp
(config-if)#ipv6 dhcp prefix-delegation prefix_xe1
(config-if)#

(config)#interface xe3
(config-if)#ipv6 address prefix_xe1 ::1:0:0:0:1/64
(config-if)#
```

ipv6 address autoconfig

Use this command to enable autoconfiguration of IPv6 address in host interface. IPv6 address are formed using the Prefix learned from RA and suffix formed using EUI-64 method.

Autoconfiguration of IPv6 address is successful when the received prefix length is 64.

Use the command `ipv6 address autoconfig max-address <1-64>` to configure the max-address that can be autoconfigured on an interface.

Use the `no` form of `ipv6 address autoconfig` command to disable the IPv6 address autoconfiguration and max-address if configured.

Use the `no` form of `ipv6 address autoconfig max-address <1-64>` to unconfigure the max-address configured on an interface and set the max-address to its default value of 15, but the autoconfig configuration remains enabled.

Command Syntax

```
ipv6 address autoconfig (max-address <1-64>|)
no ipv6 address autoconfig (max-address <1-64>|)
```

Parameters

max-address <1-64>

(Optional) The minimum number of configurable IPv6 addresses is one and the maximum is 64. The default num

Default

None

Command Mode

Interface mode

Applicability

This command was introduced in OcNOS version 4.2 and `max-address <1-64>` option is introduced in OcNOS version 6.5.1.

Examples

The below configuration shows how to configure the autoconfig:

```
OcNOS#configure terminal
OcNOS(config)#interface eth0
OcNOS(config-if)#ipv6 address autoconfig
```

The below configuration shows how to configure the number of IPv6 addresses with autoconfig:

```
OcNOS#configure terminal
OcNOS(config)#interface xel
OcNOS(config-if)#ipv6 address autoconfig max-address 64
OcNOS(config-if)#commit
OcNOS(config-if)#end
```

ipv6 dhcp client max-delegated-prefixes

Use this command to configure multiple DHCPv6 prefix delegation for a single client.

Command Syntax

```
ipv6 dhcp client max-delegated-prefixes <1-64>
```

Parameters

max-delegated-prefixes <1-64>

Specifies the number of prefixes need for a **DHCP client**¹. Default number of **DHCP**² prefixes are 8.

Default

None

Command Mode

Interface mode

Applicability

Introduced in OcNOS version 6.5.1.

Example

This example shows how to configure multiple DHCPv6 prefix delegation for a single client:

```
RR#configure terminal
RR#(config)#interface ce16/1
RR#(config-if)#ipv6 dhcp address-prefix-len 64
RR#(config-if)#ipv6 address dhcp
RR#(config-if)#ipv6 dhcp prefix-delegation PREFIX_FROM_SERVER
RR#(config-if)#ipv6 dhcp client max-delegated-prefixes 10
RR#(config-if)#exit
RR#(config)#commit
```

¹A DHCP client is a hardware device or software that uses DHCP to get the network configuration information from a DHCP Server. VRF: VRF creates a logically isolated routing table within a single physical network device. Each VRF instance works as an independent routing instance that enables separate network traffic, maintains different routing tables, and provides network isolation.

²Dynamic Host Configuration Protocol

ipv6 dhcp prefix-delegation

Use this command to enable the DHCPv6 client to request the prefix (IA_PD) for the interface.

Prefixes delegated by the **DHCP**¹ server are stored in the general prefix called PREFIX-NAME.

Use the no form of command to remove the IA_PD option from the DHCPv6 client request. This command also deletes the learned prefix if it exists.

Command Syntax

```
ipv6 dhcp prefix-delegation PREFIX-NAME
no ipv6 dhcp prefix-delegation
```

Parameters

PREFIX-NAME

Name of the learnt prefix (maximum length 255 characters).

Default

DHCPv6 Prefix delegation client is not enabled by default.

Command Mode

Interface mode

Applicability

This command was introduced in OcNOS version 4.2.

Examples

```
#configure terminal
(config)#interface xel
(config-if)#ipv6 dhcp prefix-delegation prefix_xel
(config-if)#
```

¹Dynamic Host Configuration Protocol

show ipv6 dhcp interface

Use this command to display the DHCPv6 prefix delegation information in the Requesting Router device.

Command Syntax

```
show ipv6 dhcp interface
```

Parameters

None

Command Mode

Execution mode

Applicability

This command was introduced in OcNOS version 4.2.OcNOS version 1.3.9

Examples

```
#show ipv6 dhcp interface
xe1 is in client mode
prefix name: prefix_xe1
learned prefix: 1212:501:102::/48
preferred lifetime 600, valid lifetime 600
interfaces using the learned prefix
xe3    1212:501:102:1::1
```

DHCP Server Commands

This chapter describes the Dynamic Host Configuration Protocol (**DHCP**¹) server commands.

A DHCP server is a network server that automatically provides and assigns IP addresses, default gateways, and other network parameters to client devices. A DHCP server relies on the standard protocol known as Dynamic Host Configuration Protocol or DHCP to respond to broadcast queries by clients.

This chapter contains these commands:

address range low-address A.B.C.D	462
address range low-address X:X::X:X	463
boot-file	464
dns-server A.B.C.D	465
dns-server X:X::X:X	466
domain-name	467
host-name	468
ip dhcp server (interface mode)	469
ip dhcp server default-lease-time	470
ip dhcp server max-lease-time	471
ip dhcp server pool	472
ipv6 dhcp server (interface mode)	473
ipv6 dhcp server pool	474
ipv6 dhcp server preference	475
ipv6 dhcp server rapid-commit	476
log-server	477
network A.B.C.D netmask	478
network X:X::X:X netmask	479
ntp-server A.B.C.D	480
ntp-server X:X::X:X	481
prefix high-range	482
routers A.B.C.D	483
temporary address X:X::X:X	484
tftp-server	485
vendor-options	486

¹Dynamic Host Configuration Protocol

address range low-address A.B.C.D

Use this command to create an address-range in the IPv4 **DHCP**¹ server pool.

Use the **no** form of this command to delete an address-range from the IPv4 DHCP server pool.

Command Syntax

```
address range low-address A.B.C.D (high-address A.B.C.D|)
no address range low-address A.B.C.D (high-address A.B.C.D|)
```

Parameters

low-address A.B.C.D

The low range of the IPv4 addresses that the DHCP server should assign to DHCP clients.

high-address A.B.C.D

The high range of the IPv4 addresses that the DHCP server should assign to DHCP clients.

Default

None

Command Mode

DHCP configure mode

Applicability

This command was introduced in OcNOS version 6.1.0.

Examples

```
#configure terminal
(config)#ip dhcp server pool test-pool
(dhcp-config)#address range low-address 3.3.3.1 high-address 3.3.3.4

#configure terminal
(config)#ip vrf vrf1
(config-vrf)#ip dhcp server pool test-pool
(dhcp-config)#address range low-address 3.3.3.1 high-address 3.3.3.4
```

¹Dynamic Host Configuration Protocol

address range low-address X:X::X:X

Use this command to create an address-range in the IPv6 **DHCP**¹ server pool.

Use the **no** form of this command to delete an address-range from the IPv6 DHCP server pool.

Command Syntax

```
address range low-address X:X::X:X (high-address X:X::X:X|)
no address range low-address X:X::X:X (high-address X:X::X:X|)
```

Parameters

low-address X:X::X:X

The low range of the IPv6 addresses that the DHCP server should assign to DHCP clients.

high-address X:X::X:X

The high range of the IPv6 addresses that the DHCP server should assign to DHCP clients.

Default

None

Command Mode

DHCP6 configure mode

Applicability

This command was introduced in OcNOS version 6.1.0.

Examples

```
#configure terminal
(config)#ipv6 dhcp server pool ipv6_pool
(dhcp6-config)#address range low-address 2001::1 high-address 2001::124

#configure terminal
(config)#ip vrf vrf1
(config-vrf)#ipv6 dhcp server pool ipv6_pool
(dhcp6-config)#address range low-address 2001::1 high-address 2001::124
```

¹Dynamic Host Configuration Protocol

boot-file

Use this command to specify a boot file in the IPv4 **DHCP**¹ server pool.

Use the **no** form of this command to delete a boot file from the IPv4 DHCP server pool.

Command Syntax

```
boot-file BOOTFILE
no boot-file BOOTFILE
```

Parameters

BOOTFILE

Name of the boot file (maximum 63 alphanumeric characters)

Default

No default Value is specified

Command Mode

DHCP configure mode

Applicability

This command was introduced in OcNOS version 6.1.0.

Examples

```
#configure terminal
(config)#ip dhcp server pool test-pool
(dhcp-config)#boot-file ocnos-boot-file

#configure terminal
(config)#ip vrf vrf1
(config-vrf)#ip dhcp server pool test-pool
(dhcp-config)#boot-file ocnos-boot-file
```

¹Dynamic Host Configuration Protocol

dns-server A.B.C.D

Use this command to specify a DNS name server in the IPv4 **DHCP**¹ server pool. Multiple name servers can be added to the pool.

Use the **no** form of this command to delete a DNS name server details from the IPv4 DHCP server pool.

Command Syntax

```
dns-server A.B.C.D
no dns-server A.B.C.D
```

Parameters

A.B.C.D

IPv4 DNS name server address

Default

None

Command Mode

DHCP configure mode

Applicability

This command was introduced in OcNOS version 6.1.0.

Examples

```
#configure terminal
(config)#ip dhcp server pool test-pool
(dhcp-config)#dns-server 10.12.3.23

#configure terminal
(config)#ip vrf vrf1
(config-vrf)#ip dhcp server pool test-pool
(dhcp-config)#dns-server 10.12.3.23
```

¹Dynamic Host Configuration Protocol

dns-server X:X::X:X

Use this command to specify a DNS name server in the IPv6 **DHCP**¹ server pool. Multiple DNS name servers can be added to the pool.

Use the **no** form of this command to delete a DNS name server from the IPv6 DHCP server pool.

Command Syntax

```
dns-server X:X::X:X
no dns-server X:X::X:X
```

Parameters

X:X::X:X

DNS IPv6 name server address

Default

None

Command Mode

DHCP6 configure mode

Applicability

This command was introduced in OcNOS version 6.1.0.

Examples

```
#configure terminal
(config)#ipv6 dhcp server pool ipv6_pool
(dhcp6-config)#dns-server 2001::2

#configure terminal
(config)#ip vrf vrf1
(config-vrf)#ipv6 dhcp server pool ipv6_pool
(dhcp6-config)#dns-server 2001::2
```

¹Dynamic Host Configuration Protocol

domain-name

Use this command to set the domain name in the IPv6 **DHCP**¹ server pool.

Use the **no** form of this command to delete the domain name from the IPv6 DHCP server pool.

Command Syntax

```
domain-name NAME
no domain-name NAME
```

Parameters

NAME

Name of the domain (maximum 63 alphanumeric characters)

Default

No default Value is specified

Command Mode

DHCP6 configure mode

Applicability

This command was introduced in OcNOS version 6.1.0.

Examples

```
#configure terminal
(config)#ipv6 dhcp server pool ipv6_pool
(dhcp6-config)#domain-name ipinfusion.com

#configure terminal
(config)#ip vrf vrf1
(config-vrf)#ipv6 dhcp server pool ipv6_pool
(dhcp6-config)#domain-name ipinfusion.com
```

¹Dynamic Host Configuration Protocol

host-name

Use this command to set a host name in the IPv4 **DHCP**¹ server pool.

Use the **no** form of this command to delete the host name from the IPv4 DHCP server pool.

Command Syntax

```
host-name NAME
no host-name NAME
```

Parameters

NAME

Name of the host (maximum 63 alphanumeric characters)

Default

None

Command Mode

DHCP configure mode

Applicability

This command was introduced in OcNOS version 6.1.0.

Examples

```
#configure terminal
(config)#ip dhcp server pool test-pool
(dhcp-config)#host-name dhcp-server

#configure terminal
(config)#ip vrf vrf1
(config-vrf)#ip dhcp server pool test-pool
(dhcp-config)#host-name dhcp-server
```

¹Dynamic Host Configuration Protocol

ip dhcp server (interface mode)

Use this command to configure an interface as a **DHCP**¹ server starting interface.

Use the **no** form of this command to remove an interface as a DHCP server starting interface.

Command Syntax

```
ip dhcp server  
no ip dhcp server
```

Parameters

None

Default

No default value is specified

Command Mode

Interface mode

Applicability

This command was introduced in OcNOS version 6.1.0.

Examples

```
#configure terminal  
(config)#interface eth2  
(config-if)#ip dhcp server
```

¹Dynamic Host Configuration Protocol

ip dhcp server default-lease-time

Use this command to set the default lease time for the **DHCP**¹ server to be shared with the **DHCP client**².

Use the **no** form of this command to delete the IPv4 default lease time configuration.

Command Syntax

```
ip dhcp server default-lease-time SECONDS
no ip dhcp server default-lease-time
```

Parameters

SECONDS

Default lease time in seconds. Default is 86400 seconds.

Default

Default value is 86400 seconds

Command Mode

Configure mode and **VRF**³ mode

Applicability

This command was introduced in OcNOS version 6.1.0.

Examples

```
#configure terminal
(config)#ip dhcp server default-lease-time 500

#configure terminal
(config)#ip vrf vrf1
(config-vrf)#ip dhcp server default-lease-time 400
```

¹Dynamic Host Configuration Protocol

²A DHCP client is a hardware device or software that uses DHCP to get the network configuration information from a DHCP Server. VRF: VRF creates a logically isolated routing table within a single physical network device. Each VRF instance works as an independent routing instance that enables separate network traffic, maintains different routing tables, and provides network isolation.

³Virtual Routing and Forwarding

ip dhcp server max-lease-time

Use this command to set the maximum lease time for the **DHCP**¹ server to be shared with the **DHCP client**². Use the **no** form of this command to delete the IPv4 maximum lease time configuration.

Command Syntax

```
ip dhcp server max-lease-time SECONDS
no ip dhcp server max-lease-time
```

Parameters

SECONDS

Maximum lease time in seconds. Default is 86400 seconds.

Default

Default value is 86400 seconds

Command Mode

Configure mode and **VRF**³ mode

Applicability

This command was introduced in OcNOS version 6.1.0.

Examples

```
#configure terminal
(config)#ip dhcp server max-lease-time 500

#configure terminal
(config)#ip vrf vrf1
(config-vrf)#ip dhcp server max-lease-time 400
```

¹Dynamic Host Configuration Protocol

²A DHCP client is a hardware device or software that uses DHCP to get the network configuration information from a DHCP Server. VRF: VRF creates a logically isolated routing table within a single physical network device. Each VRF instance works as an independent routing instance that enables separate network traffic, maintains different routing tables, and provides network isolation.

³Virtual Routing and Forwarding

ip dhcp server pool

Use this command to create a IPv4 **DHCP**¹ server pool.

Use the **no** form of this command to delete a IPv4 DHCP server pool.

Command Syntax

```
ip dhcp server pool NAME
no ip dhcp server pool NAME
```

Parameters

NAME

Name of the pool (maximum 63 alphanumeric characters)

Default

No default value is specified

Command Mode

Configure mode

VRF² mode

Applicability

This command was introduced in OcNOS version 6.1.0.

Examples

```
#configure terminal
(config)#ip dhcp server pool test-pool

#configure terminal
(config)#ip vrf vrf1
(config-vrf)#ip dhcp server pool test-pool
```

¹Dynamic Host Configuration Protocol

²Virtual Routing and Forwarding

ipv6 dhcp server (interface mode)

Use this command to set an interface as a DHCPv6 server starting interface.

Use the `no` form of this command to remove an interface as a DHCPv6 server starting interface.

Command Syntax

```
ipv6 dhcp server  
no ipv6 dhcp server
```

Parameters

None

Default

No default value is specified

Command Mode

Interface mode

Applicability

This command was introduced in OcNOS version 6.1.0.

Examples

```
#configure terminal  
(config)#interface eth2  
(config-if)#ipv6 dhcp server
```

ipv6 dhcp server pool

Use this command to create a IPv6 **DHCP**¹ server pool.

Use the **no** form of this command to delete a IPv6 DHCP server pool.

Command Syntax

```
ipv6 dhcp server pool NAME
no ipv6 dhcp server pool NAME
```

Parameters

NAME

Name of the pool (maximum 63 alphanumeric characters)

Default

No default value is specified

Command Mode

Configure mode and **VRF**² mode

Applicability

This command was introduced in OcNOS version 6.1.0.

Examples

```
#configure terminal
(config)#ipv6 dhcp server pool test-pool

#configure terminal
(config)#ip vrf vrf1
(config-vrf)#ipv6 dhcp server pool test-pool
```

¹Dynamic Host Configuration Protocol

²Virtual Routing and Forwarding

ipv6 dhcp server preference

Use this command to make a DHCPv6 server preferred.

Use the `no` form of this command to disable a server preference.

Command Syntax

```
ipv6 dhcp server preference
no ipv6 dhcp server preference
```

Parameters

None

Default

No default value is specified

Command Mode

Configure mode

VRF¹ mode

Applicability

This command was introduced in OcNOS version 6.1.0.

Examples

```
#configure terminal
(config)#ipv6 dhcp server preference

#configure terminal
(config)#ip vrf vrf1
(config-vrf)#ipv6 dhcp server preference
```

¹Virtual Routing and Forwarding

ipv6 dhcp server rapid-commit

Use this command to enable the **DHCP client**¹ to obtain configuration parameters from the server through a rapid two message exchange (solicit and reply).

Use the **no** form of this command to disable the IPv6 **DHCP**² server rapid-commit option.

Command Syntax

```
ipv6 dhcp server rapid-commit
no ipv6 dhcp server rapid-commit
```

Parameters

None

Default

No default value is specified

Command Mode

Configure mode

VRF³ mode

Applicability

This command was introduced in OcNOS version 6.1.0.

Examples

```
#configure terminal
(config)#ipv6 dhcp server rapid-commit

#configure terminal
(config)#ip vrf vrf1
(config-vrf)#ipv6 dhcp server rapid-commit
```

¹A DHCP client is a hardware device or software that uses DHCP to get the network configuration information from a DHCP Server. VRF: VRF creates a logically isolated routing table within a single physical network device. Each VRF instance works as an independent routing instance that enables separate network traffic, maintains different routing tables, and provides network isolation.

²Dynamic Host Configuration Protocol

³Virtual Routing and Forwarding

log-server

Use this command to specify a log server in the IPv4 **DHCP**¹ server pool. Multiple log servers can be added to the pool.

Use the **no** form of this command to delete a log server from the IPv4 DHCP server pool.

Command Syntax

```
log-server A.B.C.D
no log-server A.B.C.D
```

Parameters

A.B.C.D

IPv4 log server address

Default

No default value is specified

Command Mode

DHCP configure mode

Applicability

This command was introduced in OcNOS version 6.1.0.

Examples

```
#configure terminal
(config)#ip dhcp server pool test-pool
(dhcp-config)#log-server 10.12.43.97

#configure terminal
(config)#ip vrf vrf1
(config-vrf)#ip dhcp server pool test-pool
(dhcp-config)#log-server 10.12.43.97
```

¹Dynamic Host Configuration Protocol

network A.B.C.D netmask

Use this command to specify a network and netmask in the IPv4 **DHCP**¹ server pool.

Use the **no** form of this command to delete the network and netmask from the IPv4 DHCP server pool.

Command Syntax

```
network A.B.C.D netmask A.B.C.D
no network A.B.C.D netmask A.B.C.D
```

Parameters

network A.B.C.D

Network part of the subnet to use to assign IPv4 addresses to hosts

netmask A.B.C.D

Mask part of the subnet to use to assign IPv4 addresses to host

Default

No default value is specified

Command Mode

DHCP configure mode

Applicability

This command was introduced in OcNOS version 6.1.0.

Examples

```
#configure terminal
(config)#ip dhcp server pool test-pool
(dhcp-config)#network 3.3.3.0 netmask 255.255.255.0

#configure terminal
(config)#ip vrf vrf1
(config-vrf)#ip dhcp server pool test-pool
(dhcp-config)#network 3.3.3.0 netmask 255.255.255.0
```

¹Dynamic Host Configuration Protocol

network X:X::X:X netmask

Use this command to specify a network and netmask in the IPv6 **DHCP**¹ server pool.

Use the **no** form of this command to delete the network and netmask from the IPv6 DHCP server pool.

Command Syntax

```
network X:X::X:X netmask <1-128>
no network X:X::X:X netmask <1-128>
```

Parameters

network X:X:X:X

Network part of the subnet to use to assign IPv6 addresses to hosts

netmask <1-128>

Mask part of the subnet to use to assign IPv6 addresses to host

Default

No default value is specified

Command Mode

DHCP6 configure mode

Applicability

This command was introduced in OcNOS version 6.1.0.

Examples

```
#configure terminal
(config)#ipv6 dhcp server pool ipv6_pool
(dhcp6-config)#network 2001:: netmask 64

#configure terminal
(config)#ip vrf vrf1
(config-vrf)#ipv6 dhcp server pool ipv6_pool
(dhcp6-config)#network 2001:: netmask 64
```

¹Dynamic Host Configuration Protocol

ntp-server A.B.C.D

Use this command to specify an NTP server in the IPv4 **DHCP**¹ server pool. Multiple NTP servers can be added to the pool.

Use the **no** form of this command to delete an NTP server from the IPv4 DHCP server pool.

Command Syntax

```
ntp-server A.B.C.D
no ntp-server A.B.C.D
```

Parameters

A.B.C.D

NTP IPv4 server address

Default

None

Command Mode

DHCP configure mode

Applicability

This command was introduced in OcNOS version 6.1.0.

Examples

```
#configure terminal
(config)#ip dhcp server pool test-pool
(dhcp-config)#ntp-server 10.12.43.97

#configure terminal
(config)#ip vrf vrf1
(config-vrf)#ip dhcp server pool test-pool
(dhcp-config)#ntp-server 10.12.43.97
```

¹Dynamic Host Configuration Protocol

ntp-server X:X::X:X

Use this command to specify an NTP server in the IPv6 **DHCP**¹ server pool. Multiple NTP servers can be added to the pool.

Use the **no** form of this command to delete an NTP server from the IPv6 DHCP server pool.

Command Syntax

```
ntp-server X:X::X:X
no ntp-server X:X::X:X
```

Parameters

X:X::X:X

NTP IPv6 server address

Default

No default Value is specified

Command Mode

DHCP6 configure mode

Applicability

This command was introduced in OcNOS version 6.1.0.

Examples

```
#configure terminal
(config)#ipv6 dhcp server pool ipv6_pool
(dhcp6-config)#ntp-server 2001::2

#configure terminal
(config)#ip vrf vrf1
(config-vrf)#ipv6 dhcp server pool ipv6_pool
(dhcp6-config)#ntp-server 2001::2
```

¹Dynamic Host Configuration Protocol

prefix high-range

Use this command to add the DHCPv6 prefix range in the IPv6 **DHCP**¹ server pool used for prefix delegation. Use the *no* form of this command to delete the prefix-range from the IPv6 DHCP server pool.

Command Syntax

```
prefix high-range X:X::X:X low-range X:X::X:X netmask <1-128>
no prefix high-range X:X::X:X low-range X:X::X:X netmask <1-128>
```

Parameters

high-range X:X::X:X

IPv6 prefix high range value

low-range X:X::X:X

IPv6 prefix low range value

netmask <1-128>

Network Mask

Default

None

Command Mode

DHCL6 configure mode and **VRF**² mode

Applicability

This command is introduced in OcNOS version 6.1.0.

Example

```
#configure terminal
(config)#ipv6 dhcp server pool ipv6_pool
(dhcp6-config)#prefix high-range 3001:db8:1234:: low-range 3001:db8:1c0f:: netmask 48

#configure terminal
(config)#ip vrf vrf1
(config-vrf)#ipv6 dhcp server pool ipv6_pool
(dhcp6-config)#prefix high-range 3001:db8:1234:: low-range 3001:db8:1c0f:: netmask 48
```

¹Dynamic Host Configuration Protocol

²Virtual Routing and Forwarding

routers A.B.C.D

Use this command to specify the routers in the IPv4 **DHCP**¹ server pool.

Use the **no** form of this command to delete an routers from the IPv4 DHCP server pool.

Command Syntax

```
routers A.B.C.D
no routers A.B.C.D
```

Parameters

A.B.C.D

NTP IPv4 server address

Default

None

Command Mode

DHCP configure mode

Applicability

This command was introduced in OcNOS version 6.1.0.

Examples

```
#configure terminal
(config)#ip dhcp server pool test-pool
(dhcp-config)#routers 10.12.43.97

#configure terminal
(config)#ip vrf vrf1
(config-vrf)#ip dhcp server pool test--pool
(dhcp-config)#routers 10.12.43.97
```

¹Dynamic Host Configuration Protocol

temporary address X:X::X:X

Use this command to add an IPv6 temporary address to the IPv6 **DHCP**¹ server pool.

Use the **no** form of this command to delete an IPv6 temporary address from the IPv6 DHCP server pool.

Command Syntax

```
temporary address X:X::X:X  
no temporary address
```

Parameters

X:X::X:X

IPv6 DHCP Temporary address

Default

None

Command Mode

DHCP6 configure mode

Applicability

This command was introduced in OcNOS version 6.1.0.

Examples

```
#configure terminal  
(config)#ipv6 dhcp server pool ipv6_pool  
(dhcp6-config)#temporary address 2001::  
  
#configure terminal  
(config)#ip vrf vrf1  
(config-vrf)#ipv6 dhcp server pool ipv6_pool  
(dhcp6-config)#temporary address 2001::
```

¹Dynamic Host Configuration Protocol

tftp-server

Use this command to specify a TFTP server in the IPv4 **DHCP**¹ server pool.

Use the **no** form of this command to delete a TFTP server from the IPv4 DHCP server pool.

Command Syntax

```
tftp-server A.B.C.D
no tftp-server A.B.C.D
```

Parameters

A.B.C.D

TFTP IPv4 server address

Default

No default Value is specified

Command Mode

DHCP configure mode

Applicability

This command was introduced in OcNOS version 6.1.0.

Examples

```
#configure terminal
(config)#ip dhcp server pool test-pool
(dhcp-config)#tftp-server 10.12.43.97

#configure terminal
(config)#ip vrf vrf1
(config-vrf)#ip dhcp server pool test-pool
(dhcp-config)#tftp-server 10.12.43.97
```

¹Dynamic Host Configuration Protocol

vendor-options

Use this command to specify vendor options in the IPv6 **DHCP**¹ server pool.

Use the **no** form of this command to delete the vendor options from the IPv6 DHCP server pool.

Command Syntax

```
vendor-options VENDOR-OPTS
no vendor-options VENDOR-OPTS
```

Parameters

VENDOR-OPTS

Vendor option details

Default

None

Command Mode

DHCP6 configure mode

Applicability

This command was introduced in OcNOS version 6.1.0.

Examples

```
#configure terminal
(config)#ipv6 dhcp server pool ipv6_pool
(dhcp6-config)#vendor-options 00:00:09:bf:63

#configure terminal
(config)#ip vrf vrf1
(config-vrf)#ipv6 dhcp server pool ipv6_pool
(dhcp6-config)#vendor-options 00:00:09:bf:63
```

¹Dynamic Host Configuration Protocol

| DNS CONFIGURATION

DNS Configuration	488
Overview	488
In-band management over Default VRF	488
VRF Management Configuration-IPv4	488
VRF Management Configuration-IPv6	489
User Defined VRF Configuration-IPv4	489
User Defined Configuration-IPv6	490

DNS Configuration

Overview

The Domain Name System (DNS) is an Internet service that translates domain names into IP addresses. When a domain name is used, DNS service translates the name into the corresponding IP address. If one DNS server does not know how to translate a particular domain name, it gathers information from other Domain Name Systems to obtain the correct IP address.

In-band management over Default VRF

OcNOS supports syslog over the default and management VRFs via in-band management interface and OOB management interface, respectively.

By default, syslog runs on the management VRF¹.

Topology

Figure 30. DNS sample topology

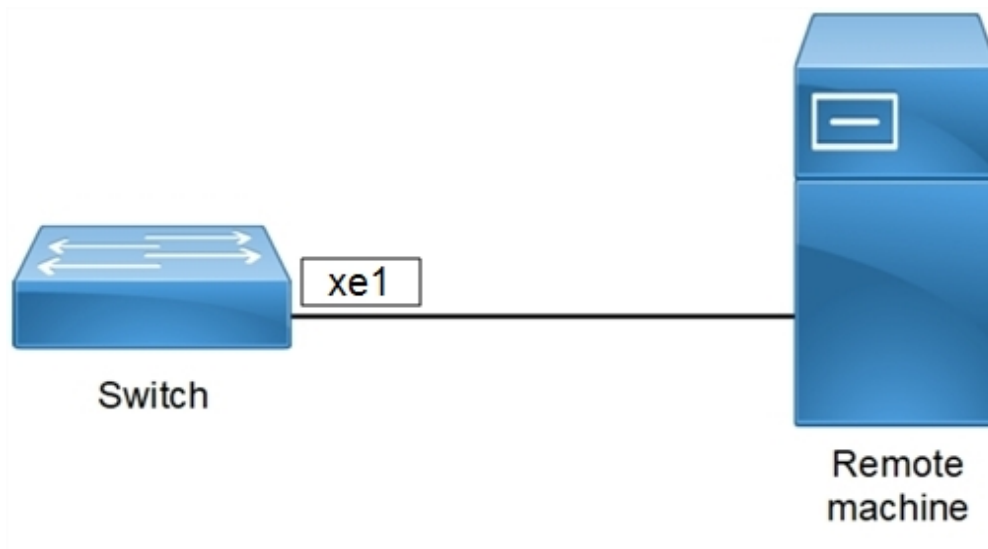

VRF Management Configuration-IPv4

#configure terminal	Enter Configure mode.
(config)#ip name-server vrf management 10.12.17.11	This add a IPv4 Name Server to the DNS.
(config)#ip name-server vrf management 10.1.1.2	This add a IPv4 Name Server to the DNS.
(config)#ip host vrf management BINGO 10.1.1.1	This will add IPv4 host to the DNS

¹Virtual Routing and Forwarding

(config)#commit	Commit the candidate configuration to the running configuration
(config)#exit	Exit configure mode.

Validation

```
#show hosts vrf management
  VRF: default

DNS lookup is disabled
Default domain is empty
DNS domain list is empty

Name Servers      : 10.12.17.11 10.1.1.2
Host              Address
-----
BINGO             10.1.1.1

* - Values assigned by DHCP Client.
```

VRF Management Configuration-IPv6

#configure terminal	Enter Configure mode.
(config)#ip name-server vrf management 3001::1	This add a IPv6 Name Server to the DNS.
(config)#ip host vrf management bingo 5001::1	This will add IPv6 host to the DNS
(config)#commit	Commit the Candidate configuration to the running configuration
(config)#exit	Exit configure mode.

Validation

```
OcNOS#show hosts vrf management
  VRF: management

DNS lookup is enabled
Default domain is empty
DNS domain list is empty

Name Servers      : 3001::1
Host              Address
-----
bingo             5001::1

* - Values assigned by DHCP Client.
OcNOS#
```

User Defined VRF Configuration-IPv4

#configure terminal	Enter Configure mode.
---------------------	-----------------------

(config)#ip vrf vrf1	Configuring user defined vrf in global.
(config)#commit	Commit the candidate configuration to the running configuration
#configure terminal	Enter Configure mode.
(config)#ip domain-lookup vrf vrf1	This command is to enable DNS for user-defined vrf.
(config)#ip name-server vrf vrf1 10.12.17.11	This add a IPv4 Name Server to the DNS
(config)#ip name-server vrf vrf1 10.1.1.2	This add a IPv4 Name Server to the DNS
(config)#ip host vrf vrf1 BINGO 10.1.1.1	This will add IPv4 host to the DNS
(config)#commit	Commit the candidate configuration to the running configuration
(config)#exit	Exit configure mode.

Validation

```
#show hosts vrf vrf1
VRF: vrf1
DNS lookup is enabled
  Default domain is empty
  DNS domain list is empty
Name Servers   : 10.12.17.11 10.1.1.2
Host   Address
BINGO  10.1.1.1
* - Values assigned by DHCP Client.
```

User Defined Configuration-IPv6

#configure terminal	Enter Configure mode.
(config)#ip name-server vrf vrf1 3001::1	This add a IPv6 Name Server to the DNS.
(config)#ip host vrf vrf1 bingo 5001::1	This will add IPv6 host to the DNS
(config)#commit	Commit the Candidate configuration to the running configuration
(config)#exit	Exit configure mode.

Validation

```
OcNOS#show hosts vrf vrf1
VRF: vrf1

  DNS lookup is disabled
  Default domain is empty
  DNS domain list is empty

Name Servers   : 3001::1
Host   Address
----   -
bingo   5001::1
* - Values assigned by DHCP Client.
```

| DNS COMMAND REFERENCE

Domain Name System Commands	492
debug dns client	492
ip domain-list	493
ip domain-lookup	494
ip domain-name	494
ip host	495
ip name-server	496
show hosts	497
show running-config dns	498

Domain Name System Commands

This chapter describes Domain Name System (DNS) commands. DNS translates easy-to-remember domain names into numeric IP addresses needed to locate computer services and devices. By providing a worldwide, distributed keyword-based redirection service, DNS is an essential component of the Internet.

The DNS database is hierarchical. When a client such as a Web browser gives a request that specifies a host name, the DNS resolver on the client first contacts a DNS server to determine the server's IP address. If the DNS server does not contain the needed mapping, it forwards the request to a different DNS server at the next higher level in the hierarchy. After potentially several forwarding and delegation messages are sent within the DNS hierarchy, the IP address for the given host eventually arrives at the resolver, that in turn completes the request over Internet Protocol (IP).



Note: The commands below are supported only on the “management” VRF¹.

The chapter contains these commands:

debug dns client	492
ip domain-list	493
ip domain-lookup	494
ip domain-name	494
ip host	495
ip name-server	496
show hosts	497
show running-config dns	498

debug dns client

Use this command to display DNS debugging messages.

Use the **no** form of this command to stop displaying DNS debugging messages.

Command Syntax

```
debug dns client
no debug dns client
```

Parameters

None

Default

NoneBy default, disabled.

¹Virtual Routing and Forwarding

Command Mode

Execution mode, Privileged execution mode, and Configure mode

Applicability

This command was introduced before OcNOS version 1.3.

Examples

```
#configure terminal
(config)#debug dns client
```

ip domain-list

Use this command to define a list of default domain names used to complete unqualified host names. Each domain in the list is to be tried in turn.

The `ip domain-list` command is similar to the [ip domain-name \(page 494\)](#) command, except that with the `ip domain-list` command you can define a list of domains, each to be tried in turn.

If there is no domain list, the default domain name specified with the `ip domain-name` command is used. If there is a domain list, the default domain name is not used.

Use the `no` form of this command to remove a domain.

Command Syntax

```
ip domain-list (vrf (NAME|management)|) DOMAIN-NAME
no ip domain-list (vrf (NAME|management)|) DOMAIN-NAME
```

Parameters

DOMAIN-NAME

Domain string (e.g. company.com)(Max Size 64)

vrf management

Defines the management **VRF**¹ instance.

vrf NAME

Specify the user-defined VRF instance name.

Default

Disabled

Command Mode

Configure mode

Applicability

This command was introduced before OcNOS version 1.3. Added parameter NAME in OcNOS version 6.5.3.

¹Virtual Routing and Forwarding

Example

```
#configure terminal
(config)#ip domain-list mySite.com
```

ip domain-lookup

Use this command to enable DNS host name-to-address translation.

Use the **no** form of this command to disable DNS.

Command Syntax

```
ip domain-lookup (vrf (NAME|management)|)
no ip domain-lookup (vrf (NAME|management)|)
```

Parameters

vrf management

Defines the management **VRF**¹ instance

vrf NAME

Specify the user-defined VRF instance name

Default

None

Command Mode

Configure mode

Applicability

This command was introduced before OcNOS version 1.3. Added parameter NAME in OcNOS version 6.5.3.

Example

```
#configure terminal
(config)#ip domain-lookup
```

ip domain-name

Use this command to set the default domain name used to complete unqualified host names (names without a dotted-decimal domain name).

The [ip domain-list \(page 493\)](#) command is similar to the **ip domain-name** command, except that with the **ip domain-list** command you can define a list of domains, each to be tried in turn.

If a domain list has been created with [ip domain-list \(page 493\)](#), the default domain name is not used. If there is no domain list, the default domain name is used.

¹Virtual Routing and Forwarding

Use the **no** form of this command to disable DNS.

Command Syntax

```
ip domain-name (vrf (NAME|management)|) DOMAIN-NAME
no ip domain-name (vrf (NAME|management)|) DOMAIN-NAME
```

Parameters

DOMAIN-NAME

Domain string (e.g. company.com)(Max Size 64)

vrf management

Defines the management VRF¹ instance.

vrf NAME

Specify the user-defined VRF instance name.

Default

None

Command Mode

Configure mode

Applicability

This command was introduced before OcNOS version 1.3. Added NAME parameter in OcNOS version 6.5.3.

Example

```
#configure terminal
(config)#ip domain-name company.com
```

ip host

Use this command to define static a hostname-to-address mapping in DNS. You can specify one mapping in a command.

Use the **no** form of this command remove a hostname-to-address mapping.



Note: If the command **ip host <hostname> <ip>** is enabled and the hostname is configured for any feature, the old IP associated with the hostname will be used until the feature is disabled and re-enabled, even if the IP associated with the hostname is changed later.

Command Syntax

```
ip host (vrf (NAME|management)|) WORD (X:X::X:X | A.B.C.D)
no ip host (vrf (NAME|management)|) WORD (X:X::X:X | A.B.C.D)
```

¹Virtual Routing and Forwarding

Parameters

WORD

Host name, such as company.com

X:X::X:X

IPv6 address of the host

A.B.C.D

IPv4 address of the host

vrf management

Defines the management **VRF**¹ instance.

vrf NAME

Specify the user-defined VRF instance name.

Default

None

Command Mode

Configure mode

Applicability

This command was introduced before OcNOS version 1.3. Added parameter NAME in OcNOS version 6.5.3

Examples

```
#configure terminal
(config)#ip host company.com 192.0.2.1
```

ip name-server

Use this command to add a DNS server address that is used to translate hostnames to IP addresses.

Use the **no** form of this command to remove a DNS server address.



Note: If the hostname resolution takes time even after adding proper name-servers, check the list of name-servers added. Non-responsive name-servers take a long time to resolve the hostnames and result in utilities timeout and "Failed to resolve hostname" error. Ensure that the non-reachable/non-DNS name-servers are removed from the configured list.

Command Syntax

```
ip name-server (vrf (NAME|management)|) (X:X::X:X | A.B.C.D)
no ip name-server (vrf (NAME|management)|) (X:X::X:X | A.B.C.D)
```

¹Virtual Routing and Forwarding

Parameters

A.B.C.D

IPv4 address of the host

X:X::X:X

IPv6 address of the host

vrf management

Defines the management **VRF**¹ instance.

vrf NAME

Specify the user-defined VRF instance name.

Default

None

Command Mode

Configure mode

Applicability

This command was introduced before OcNOS version 1.3. Added parameter NAME in OcNOS version 6.5.3.

Examples

```
#configure terminal
(config)#ip name-server 123.70.0.23
```

show hosts

Use this command to display the DNS name servers and domain names.

Command Syntax

```
show hosts (vrf (NAME|management|all))
```

Parameters

vrf management

Defines the management **VRF**² instance.

vrf NAME

Specify the user-defined VRF instance name.

Command Mode

Execution mode and Privileged execution mode

¹Virtual Routing and Forwarding

²Virtual Routing and Forwarding

Applicability

This command was introduced before OcNOS version 1.3. Added VRF NAME parameter in OcNOS version 6.5.3.

Example

The following is a sample output of this command displaying two name servers: 10.10.0.2 and 10.10.0.88.

```
#show hosts
    VRF: management

DNS lookup is enabled
  Default domain      : .com
  Additional Domain   : .in .ac
  Name Servers        : 10.12.3.23
Host                  Address
----                -
test                 10.12.12.67
test                 10::23

* - Values assigned by DHCP Client.
```

[Table 21](#) explains the output fields.

Table 21. show hosts fields

Entry	Description
VRF: management	DNS configuration of specified VRF.
DNS lookup is enabled	DNS feature enabled or disabled.
Default domain	Default domain name used to complete unqualified host names (names without a dotted decimal domain name).
Additional Domain	A list of default domain names used to complete unqualified host names. Each domain in the list is to be tried in turn.
Name Servers	DNS server addresses that are used to translate hostnames to IP addresses.
Host	Static hostname-to-address mappings in DNS.
Test	Static hostname-to-address mappings in DNS.
* - Values assigned by DHCP ¹ Client.	Name-server indicates it has been learned dynamically.

show running-config dns

Use this command to show the DNS settings of the running configuration.

Command Syntax

```
show running-config dns (vrf (NAME|management)|)
```

¹Dynamic Host Configuration Protocol

Parameters

vrf management

Defines the management **VRF**¹ instance.

vrf NAME

Specify the user-defined VRF instance name.

Command Mode

Execution mode and Privileged execution mode

Applicability

This command was introduced before OcNOS version 1.3. Added VRF NAME parameter in OcNOS version 6.5.3.

Example

```
#show running-config dns
ip domain-lookup vrf management
ip domain-name vrf management .com
ip domain-list vrf management .in
ip domain-list vrf management .ac
ip name-server vrf management 10.12.3.23
ip host vrf management test 10.12.12.67 10::23
```

¹Virtual Routing and Forwarding

NTP CONFIGURATION GUIDE

NTP Client Configuration	501
Overview	501
In-band management via Default VRF	501
NTP Modes	501
NTP Client Configuration with IPv4 Address	502
NTP Client Configuration with IPv6 Address	505
NTP Server Configuration	510
Topology	510
Configuration	510
Validation	511
Synchronization of more than one NTP clients with the NTP Master	511
Synchronization with Authentication	515
Synchronization of NTP Server and NTP Clients with NTP ACL	519
Synchronization of NTP Server and NTP Clients with NTP ACL configured as noserve	524
Synchronization of NTP Client with Stratum 2 NTP Master	528

NTP Client Configuration

Overview

NTP modes differ based on how NTP allows communication between systems. NTP communication consists of time requests and control queries. Time requests provide the standard client/server relationship in which a client requests time synchronization from an NTP server. Control queries provide ways for remote systems to get configuration information and reconfigure NTP servers.

In-band management via Default VRF

OcNOS now offers support for NTP over default and management VRFs via in-band management interface & OOB management interface, respectively.

The feature can either be running on the default or management **VRF**¹. By default, it runs on the management VRF.

NTP Modes

The following describes the various NTP node types.

Client

An NTP client is configured to let its clock be set and synchronized by an external NTP timeserver. NTP clients can be configured to use multiple servers to set their local time and are able to give preference to the most accurate time sources. They do not, however, provide synchronization services to any other devices.

Server

An NTP server is configured to synchronize NTP clients. Servers can be configured to synchronize any client or only specific clients. NTP servers, however, will accept no synchronization information from their clients and therefore will not let clients update or affect the server's time settings.

Peer

With NTP peers, one NTP-enabled device does not have authority over the other. With the peering model, each device shares its time information with the others, and each device can also provide time synchronization to the others.

Authentication

For additional security, you can configure your NTP servers and clients to use authentication. Routers support MD5 authentication for NTP. To enable a router to do NTP authentication:

¹Virtual Routing and Forwarding

1. Enable NTP authentication with the `ntp authenticate` command.
2. Define an NTP authentication key with the `ntp authentication-key vrf management` command. A unique number identifies each NTP key. This number is the first argument to the `ntp authentication-key vrf management` command.
3. Use the `ntp trusted-key vrf management` command to tell the router which keys are valid for authentication. If a key is trusted, the system will be ready to synchronize to a system that uses this key in its NTP packets. The trusted key should already be configured and authenticated.

NTP Client Configuration with IPv4 Address

NTP client, user can configure an association with a remote server. In this mode the client clock can synchronize to the remote server

After configuring the NTP servers, wait a few minutes before you verify that clock synchronization is successful. When the clock synchronization has actually happened, there will be an '*' symbol along with the interface while you give the `show ntp peers` command.

Topology

Figure 31. SNTP Client and Server

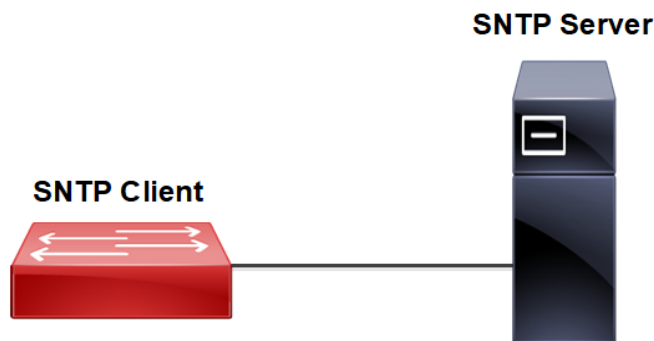

NTP Client for User Management

<code>#configure terminal</code>	Enter Configure mode.
<code>(config)#feature ntp vrf management</code>	Configure feature on default or management VRF ¹ . By default this feature runs on management VRF.
<code>(config)#ntp enable vrf management</code>	This feature enables ntp. This will be enabled in default.
<code>(config)#ntp server 10.1.1.1 vrf management</code>	Configure ntp server ip address.
<code>(config)#commit</code>	Commit the configuration
<code>(config)#exit</code>	Exit from the Configure Mode.

Validation

```
#show ntp peers
```

¹Virtual Routing and Forwarding

```

-----
Peer IP Address Serv/Peer
-----
10.1.1.1 Server (configured)

#show ntp peer-status
Total peers : 1
* - selected for sync, + - peer mode(active),
- - peer mode(passive), = - polled in client mode
  remote          refid          st t when poll reach  delay  offset  jitter
=====
*10.1.1.1         LOCAL(0)          7 u  14  32  37   0.194  -4.870  3.314
    
```

NTP Client for User Defined VRF

#configure terminal	Enter Configure mode.
(config)#feature ntp vrf vrf1	Configure feature on default or management VRF. By default this feature runs on management VRF.
(config)#ntp enable vrf vrf1	This feature enables ntp. This will be enabled in default.
(config)ntp server 192.168.2.2 vrf vrf1	Configure ntp server ip address.
(config)#commit	Commit the configuration
(config)#exit	Exit from the Configure Mode.

Validation

```

#show ntp peers
-----
Peer IP Address Serv/Peer
-----
10.1.1.1 Server (configured)

#show ntp peer-status
Total peers : 1
* - selected for sync, + - peer mode(active),
- - peer mode(passive), = - polled in client mode
  remote          refid          st t when poll reach  delay  offset  jitter
=====
*10.1.1.1         LOCAL(0)          7 u  14  32  37   0.194  -4.870  3.314
    
```

Maxpoll and Minpoll Configuration

The maximum poll interval are specified in defaults to 6 (64 seconds), but can be increased by the **maxpoll** option to an upper limit of 16 (18.2 hours). The minimum poll interval defaults to 4 (16 seconds), and this is also the minimum value of the **minpoll** option.

The client will retry between **minpoll** and **maxpoll** range configured for synchronization with the server.

Management VRF for Client

#configure terminal	Enter Configure mode.
(config)#feature ntp vrf management	Configure feature on default or management VRF ¹ . By

¹Virtual Routing and Forwarding

	default this feature runs on management VRF.
(config)#ntp server 10.1.1.1 maxpoll 7 minpoll 5 vrf management	Configure minpoll and maxpoll range for ntp server.
(config)#commit	Commit the configuration
(config)#exit	Exit from the Configure Mode.

Validation

```
#show ntp peers
-----
Peer IP Address Serv/Peer
-----
10.1.1.1 Server (configured)

#show ntp peer-status
Total peers : 1
* - selected for sync, + - peer mode(active),
- - peer mode(passive), = - polled in client mode
  remote          refid          st t when poll reach  delay  offset  jitter
=====
*10.1.1.1         LOCAL(0)          7 u  14  32  37   0.194  -4.870  3.314
```

User Defined VRF for Client

#configure terminal	Enter Configure mode.
(config)#feature ntp vrf vrf1	Configure feature on default or management VRF. By default this feature runs on management VRF.
(config)#ntp server 192.168.2.2 maxpoll 7 minpoll 5 vrf vrf1	Configure minpoll and maxpoll range for ntp server.
(config)#commit	Commit the configuration
(config)#exit	Exit from the Configure Mode.

Validation

```
#show ntp peers
-----
Peer IP Address Serv/Peer
-----
10.1.1.1 Server (configured)

#show ntp peer-status
Total peers : 1
* - selected for sync, + - peer mode(active),
- - peer mode(passive), = - polled in client mode
  remote          refid          st t when poll reach  delay  offset  jitter
=====
*10.1.1.1         LOCAL(0)          7 u  14  32  37   0.194  -4.870  3.314  3.314
```

NTP Authentication

When you enable NTP authentication, the device synchronizes to a time source only if the source carries the authentication keys specified with the source by key identifier. The device drops any packets that fail the authentication check, and prevents them from updating the local clock.

Client

#configure terminal	Enter Configure mode.
(config)#feature ntp vrf vrf1	Enable feature on default or management VRF ¹ . By default this feature runs on management VRF..
(config)#ntp server 192.168.2.2 vrf vrf1	Configure ntp server ip address.
(config)#ntp authenticate vrf vrf1	Enable NTP Authenticate. NTP authentication is disabled by default.
(config)#ntp authentication-key 1 md5 cisco vrf vrf1	Configure ntp authentication key along with md5 value.
(config)#ntp request-key 1 vrf vrf1	Configure reuest-key
(config)#ntp trusted-key 1 vrf vrf1	Configure trusted key <1-65535>
(config)#commit	Commit the configuration
(config)#exit	Exit from the Configure Mode.

Validation

```
#show ntp authentication-status
Authentication enabled
```

```
#show ntp authentication-keys
-----
Auth Key      MD5 String
-----
1234          SWWX
```

```
#show ntp trusted-keys
Trusted Keys:
1234
```

NTP Client Configuration with IPv6 Address

NTP client, user can configure an association with a remote server. In this mode the client clock can synchronize to the remote server.

¹Virtual Routing and Forwarding

Topology

Figure 32. NTP Client topology



Configuration of VRF Management

#configure terminal	Enter configure mode
(config)#feature ntp vrf management	Configure feature on default or management VRF ¹ . By default this feature runs on management VRF.
(config)# ntp enable vrf management	This feature enables NTP. This will be enabled in default.
(config)#ntp server 2001::1 vrf management	Configure NTP server IP address.
(config)#commit	Commit the configuration
(config)#exit	Exit from the Configure Mode.

Validation

```
#show ntp peers
=====
Peer IP Address Serv/Peer
=====
2001::1 Server (configured)
#show ntp peer-status
Total peers : 1
* - selected for sync, + - peer mode(active),
- - peer mode(passive), = - polled in client mode
Remote  refid      st when                poll reach delay  offset    jitter
=====
*2001::1      LOCAL(0) 7 u   14 32 37   0.194      -4.870    3.314
```

Configuration of User Defined VRF

#configure terminal	Enter configure mode
(config)#feature ntp vrf vrf1	Configure feature on default or management VRF. By default this feature runs on management VRF.

¹Virtual Routing and Forwarding

(config)# ntp enable vrf vrf1	This feature enables NTP. This will be enabled in default.
(config)#ntp server 2001::1 vrf vrf1	Configure NTP server IP address.
(config)#commit	Commit the configuration
(config)#exit	Exit from the Configure Mode.

Validation

```
#show ntp peers
=====
Peer IP Address Serv/Peer
=====
2001::1 Server (configured)
#show ntp peer-status
Total peers : 1
* - selected for sync, + - peer mode(active),
- - peer mode(passive), = - polled in client mode
Remote  refid      st when          poll reach delay  offset      jitter
=====
*2001::1      LOCAL(0) 7 u   14 32 37   0.194      -4.870      3.314
```

Maxpoll and Minpoll Configuration

The maximum poll interval are specified in defaults to 6 (64 seconds), but can be increased by the maxpoll option to an upper limit of 16 (18.2 hours). The minimum poll interval defaults to 4 (16 seconds), and this is also the minimum value of the minpoll option. The client will retry between minpoll and maxpoll range configured for synchronization with the server.

VRF Management for Client

#configure terminal	Enter configure mode
(config)#feature ntp vrf management	Configure feature on default or management VRF ¹ . By default this feature runs on management VRF
(config)#ntp server 2001::1 maxpoll 7 minpoll 5 vrf management	Configure minpoll and maxpoll range for NTP server
(config)#commit	Commit the configuration
(config)#exit	Exit from the Configure Mode

Validation

```
#show ntp peers
=====
Peer IP Address Serv/Peer
=====
2001::1 Server (configured)
#show ntp peer-status
Total peers : 1
* - selected for sync, + - peer mode(active),
- - peer mode(passive), = - polled in client mode
Remote  refid      st when          poll reach delay  offset      jitter
=====
*2001::1      LOCAL(0) 7 u   14 32 37   0.194      -4.870      3.314
```

¹Virtual Routing and Forwarding

User Defined VRF for Client

#configure terminal	Enter configure mode
(config)#feature ntp vrf vrf1	Configure feature on default or management VRF. By default this feature runs on management VRF
(config)#ntp server 2001::1 maxpoll 7 minpoll 5 vrf vrf1	Configure minpoll and maxpoll range for NTP server
(config)#commit	Commit the configuration
(config)#exit	Exit from the Configure Mode

Validation

```
#show ntp peers
=====
Peer IP Address Serv/Peer
=====
2001::1 Server (configured)
#show ntp peer-status
Total peers : 1
* - selected for sync, + - peer mode(active),
-- peer mode(passive), = - polled in client mode
Remote refid st when poll reach delay offset jitter
=====
*2001::1 LOCAL(0) 7 u 14 32 37 0.194 -4.870 3.314 3.314
```

NTP Authentication

When you enable NTP authentication, the device synchronizes to a time source only if the source carries the authentication keys specified with the source by key identifier. The device drops any packets that fail the authentication check, and prevents them from updating the local clock.

VRF Management for Client

#configure terminal	Enter configure mode
(config)#feature ntp vrf management	Enable feature on default or management VRF ¹ . By default this feature runs on management VRF..
(config)#ntp server 2001::1 vrf management	Configure NTP server IP address.
(config)#ntp authenticate vrf management	Enable NTP Authenticate. NTP authentication is disabled by default.
(config)#ntp authentication-key 1234 md5 text vrf management	Configure NTP authentication key along with MD5 value.
(config)#ntp trusted-key 1234 vrf management	Configure trusted key
(config)#commit	Commit the configuration
(config)#exit	Exit from the Configure Mode.

¹Virtual Routing and Forwarding

Validation

```
#show ntp authentication-status
Authentication enabled

#show ntp authentication-keys
----- Auth Key   MD5 String -----
                1234       SWWX

#show ntp trusted-keys
Trusted Keys: 1234
```

User Defined VRF for Client

#configure terminal	Enter configure mode
(config)#feature ntp vrf vrf1	Enable feature on default or management VRF. By default this feature runs on management VRF..
(config)#ntp server 2001::1 vrf vrf1	Configure NTP server IP address.
(config)#ntp authenticate vrf vrf1	Enable NTP Authenticate. NTP authentication is disabled by default.
(config)#ntp authentication-key 1 md5 cisco vrf vrf1	Configure NTP authentication key along with MD5 value.
config)#ntp request-key 1 vrf vrf1	Configure request key.
(config)#ntp trusted-key 1 vrf vrf1	Configure trusted key
(config)#commit	Commit the configuration
(config)#exit	Exit from the Configure Mode.

Validation

```
#show ntp authentication-status
Authentication enabled

#show ntp authentication-keys
----- Auth Key   MD5 String -----
                1234       SWWX

#show ntp trusted-keys
Trusted Keys: 1234
```

NTP Server Configuration

The Network Time Protocol (NTP) synchronizes the time of day among a set of distributed time servers and clients so that you can correlate events when you receive system logs and other time-specific events from multiple network de-vices. NTP uses the User Datagram Protocol (**UDP**¹) as its transport protocol. All NTP communications use Coordinated Universal Time (UTC).

An NTP server usually receives its time from an authoritative time source, such as a radio clock or an atomic clock attached to a time server, and then distributes this time across the network.

The NTP Server and Client functionality explained above will be supported in OcNOS. NTP Access restrictions can be configured to allow Client devices to access NTP Server.

Topology

The procedures in this section use the topology as mentioned below :

Setup consists of two nodes. One node acting as NTP Master and the other node acting as NTP Client.

Figure 33. Synchronization of NTP Master and NTP Client

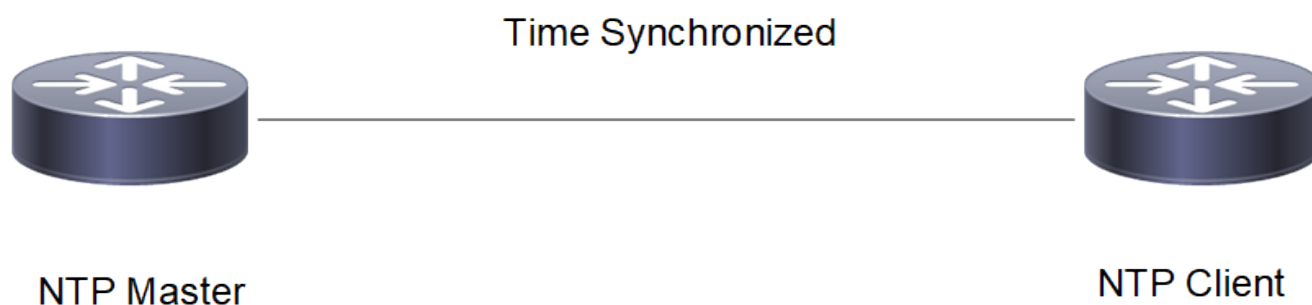

Configuration

NTP Master

<code>#configure terminal</code>	Enter configure mode.
<code>(config)#feature ntp vrf management</code>	Enable feature NTP.
<code>(config)#ntp enable vrf management</code>	Enable NTP.
<code>(config)#ntp master vrf management</code>	Configure the node as NTP master.
<code>(config)#ntp master stratum 1 vrf management</code>	Configure the NTP stratum level as 1 indicating that it is using local clock.
<code>(config)#ntp allow 10.12.20.6 vrf management</code>	Configure NTP client address in the NTP allow list.
<code>(config)#commit</code>	Commit the candidate configuration to the running

¹User Datagram Protocol

	configuration.
(config)#exit	Exit configure mode.

NTP Client

#configure terminal	Enter configure mode.
(config)#feature ntp vrf management	Enable feature NTP.
(config)#ntp enable vrf management	Enable NTP.
(config)#ntp server 10.12.20.5 vrf management	Configure NTP server address for the sync to happen.
(config)#commit	Commit the candidate configuration to the running configuration.
(config)#exit	Exit Configure mode.

Validation

Check the local clock synchronization in the NTP Master as mentioned below:

```
VTEP1#show ntp peer-status
  remote          refid          st t when poll reach  delay  offset  jitter
=====
*127.127.1.0     .LOCL.             1 1  59  64  377  0.000  0.000  0.000
```

Check the ntp client synchronization status as mentioned below:

```
#show ntp peer-status
Total peers : 1
* - selected for sync, + - peer mode(active),
- - peer mode(passive), = - polled in client mode,
x - source false ticker
  remote          refid          st t when poll reach  delay  offset  jitter
=====
*10.12.20.5     LOCAL(0)          2 u   4  16  377  0.137  -0.030  0.004
```

Synchronization of more than one NTP clients with the NTP Master

In the below section, check the Synchronization of more than one NTP clients with the NTP Master using Subnet definition on the NTP Master.

Topology

The procedures in this section use the topology as mentioned below:

Setup consists of three nodes. One node acting as NTP Master and the other two nodes acting as NTP Clients.

Figure 34. Synchronization of more than one NTP clients with NTP Master using subnet definition

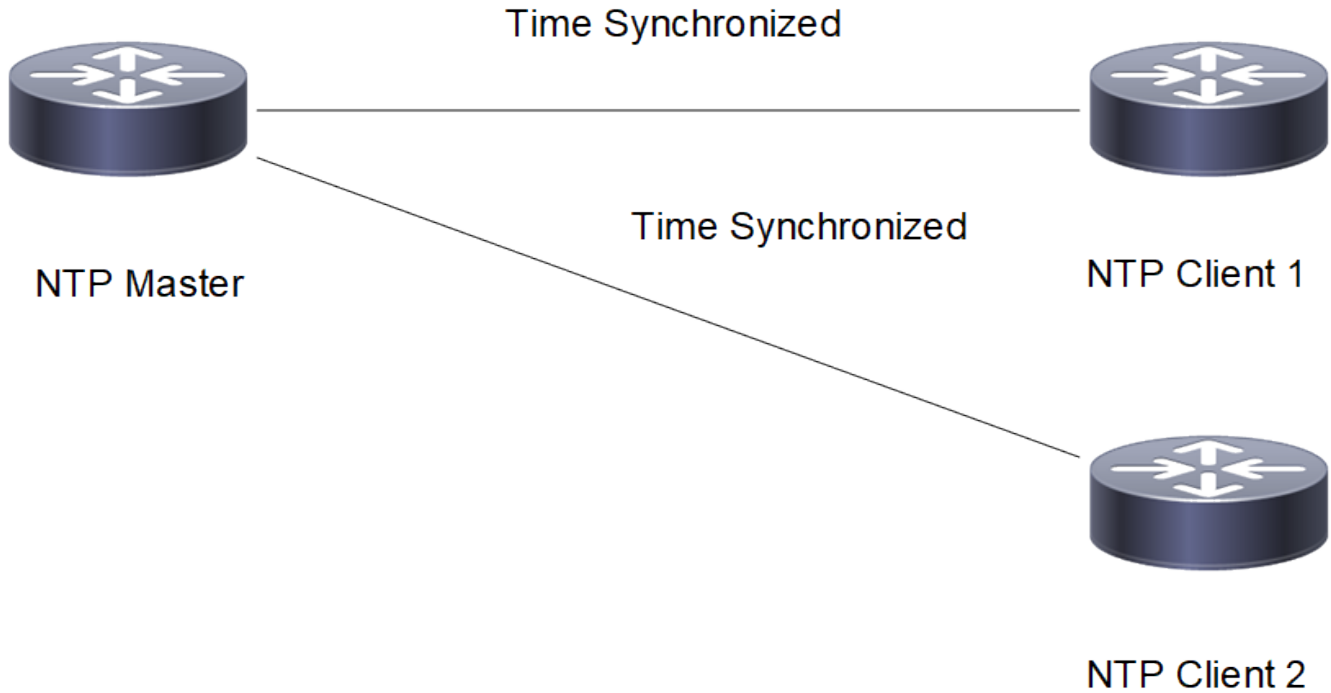

VRF Management Configuration

NTP Master

<code>#configure terminal</code>	Enter configure mode
<code>(config)# feature ntp vrf management</code>	Enable feature ntp
<code>(config)# ntp enable vrf management</code>	Enable ntp
<code>(config)# ntp master vrf management</code>	Configure the node as NTP master
<code>(config)# ntp master stratum 1 vrf management</code>	Configure the ntp stratum level as 1 indicating that it is using local clock
<code>(config)# ntp allow 10.12.20.6 mask 255.255.255.0 vrf management</code>	Configure the mask in the ntp allow list
<code>(config)#commit</code>	Commit the candidate configuration to the running configuration
<code>(config)# exit</code>	Exit configure mode

NTP Client1

<code>#configure terminal</code>	Enter configure mode.
<code>(config)# feature ntp vrf management</code>	Enable feature ntp.
<code>(config)# ntp enable vrf management</code>	Enable ntp
<code>(config)# ntp server 10.12.20.5 vrf management</code>	Configure ntp server address for the sync to happen

(config)#commit	Commit the candidate configuration to the running configuration
(config)# exit	Exit Configure mode

NTP Client2

#configure terminal	Enter configure mode.
(config)# feature ntp vrf management	Enable feature ntp.
(config)# ntp enable vrf management	Enable ntp
(config)# ntp server 10.12.20.5 vrf management	Configure ntp server address for the sync to happen
(config)#commit	Commit the candidate configuration to the running configuration
(config)# exit	Exit Configure mode

Validation

Check the local clock synchronization in the NTP Master as mentioned below:

```
VTEP1#show ntp peer-status
  remote          refid          st t when poll reach  delay  offset  jitter
=====
*127.127.1.0     .LOCL.             1 l  59  64  377   0.000   0.000   0.000

Check the ntp client1 synchronization status as mentioned below :
#show ntp peer-status
Total peers : 1
* - selected for sync, + - peer mode(active),
- - peer mode(passive), = - polled in client mode,
x - source false ticker
  remote          refid          st t when poll reach  delay  offset  jitter
=====
*10.12.20.5     LOCAL(0)           2 u   8  32  377   0.153  -0.053   0.020
```

Check the ntp client2 synchronization status as mentioned below:

```
VTEP2#show ntp peer-status
Total peers : 1
* - selected for sync, + - peer mode(active),
- - peer mode(passive), = - polled in client mode,
x - source false ticker
  remote          refid          st t when poll reach  delay  offset  jitter
=====
*10.12.20.5     LOCAL(0)           2 u  14  16  377   0.150  -0.686   0.034
```

User Defined VRF Configuration

NTP Master

#configure terminal	Enter configure mode
(config)# feature ntp vrf vrf1	Enable feature ntp
(config)# ntp enable vrf vrf1	Enable ntp
(config)# ntp master vrf vrf1	Configure the node as NTP master
(config)# ntp master stratum 1 vrf vrf1	Configure the ntp stratum level as 1 indicating that it

	is using local clock
(config)# ntp allow 192.168.2.0 mask 255.255.255.0 vrf vrf1	Configure the mask in the ntp allow list for ipv4
(config)# ntp allow 2001:: mask 64 vrf vrf1	Configure the mask in the ntp allow list for ipv6
(config)# ntp allow 5001:: mask 64 vrf vrf1	Configure the mask in the ntp allow list for ipv6
(config)#commit	Commit the candidate configuration to the running configuration
(config)# exit	Exit configure mode

NTP Client1

#configure terminal	Enter configure mode.
(config)# feature ntp vrf vrf1	Enable feature ntp.
(config)# ntp enable vrf vrf1	Enable ntp
(config)# ntp server 192.168.3.2 vrf vrf1	Configure ipv4 ntp server address for the sync to happen
(config)# ntp server 2001::2 vrf vrf1	Configure ipv6 ntp server address for the sync to happen
(config)#commit	Commit the candidate configuration to the running configuration
(config)# exit	Exit Configure mode

NTP Client2

#configure terminal	Enter configure mode.
(config)# feature ntp vrf vrf1	Enable feature ntp.
(config)# ntp enable vrf vrf1	Enable ntp
(config)# ntp server 192.168.2.2 vrf vrf1	Configure ipv4 ntp server address for the sync to happen
(config)# ntp server 5001::2 vrf vrf1	Configure ipv6 ntp server address for the sync to happen
(config)#commit	Commit the candidate configuration to the running configuration
(config)# exit	Exit Configure mode

Validation

Check the local clock synchronization in the NTP Master as mentioned below:

```
ntpmaster#show ntp peer-status
remote      refid      st t when poll reach  delay  offset  jitter
=====
*127.127.1.0 .LOCL.      1 1  46  64  377  0.000  0.000  0.000
```

Check the ntp client1 synchronization status as mentioned below:

```
ntpclient-7012#show ntp peer-status
Total peers : 2
* - selected for sync, + - peer mode(active),
- - peer mode(passive), = - polled in client mode,
x - source false ticker
  remote          refid          st t when poll reach  delay  offset  jitter
=====
*192.168.2.2      LOCAL(0)         2 u  54  64  377  0.410  0.088  0.026
+2001::2         LOCAL(0)         2 u  54  64  377  0.453  0.019  0.206
```

Check the ntp client2 synchronization status as mentioned below:

```
ntpclient-7025#show ntp peer-status
Total peers : 2
* - selected for sync, + - peer mode(active),qw
- - peer mode(passive), = - polled in client mode,
x - source false ticker
  remote          refid          st t when poll reach  delay  offset  jitter
=====
*192.168.3.2      LOCAL(0)         2 u  30  64  377  0.476  -0.021  0.033
+5001::2         LOCAL(0)         2 u  34  64  377  0.451  -0.060  0.040
```

Synchronization with Authentication

In the below section, check the synchronization of NTP Master and NTP Client with Authentication.

Topology

The procedures in this section use the topology as mentioned below:

Setup consists of three nodes. One node acting as NTP Master and the other two nodes acting as NTP Clients.

Figure 35. Synchronization of NTP Master and NTP Clients using authentication

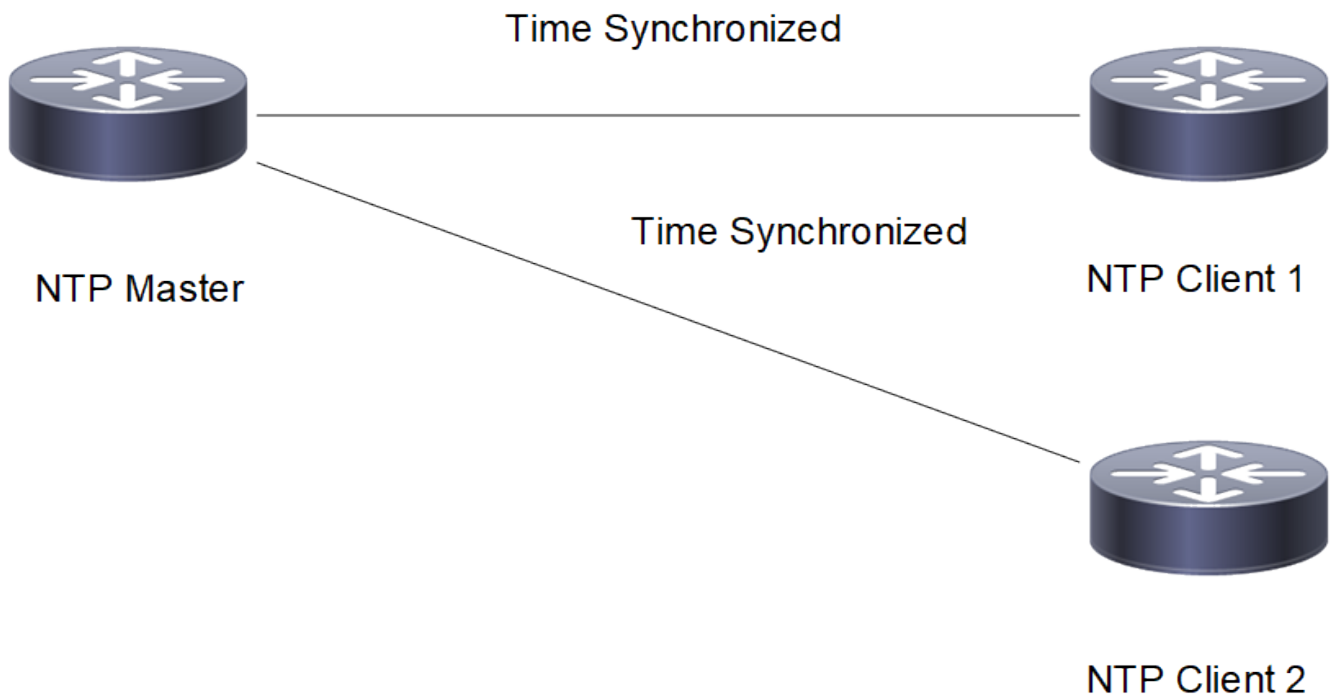

VRF Management Configuration

NTP Master

#configure terminal	Enter configure mode
(config)# feature ntp vrf management	Enable feature ntp
(config)# ntp enable vrf management	Enable ntp
(config)# ntp master vrf management	Configure the node as NTP master
(config)# ntp master stratum 1 vrf management	Configure the ntp stratum level as 1 indicating that it is using local clock
(config)# ntp authenticate vrf management	Configure ntp server for authentication
(config)# ntp authentication-key 65 md5 test123 vrf management	Configure ntp authentication key with password
(config)# ntp trusted-key 65 vrf management	Configure ntp trusted key
(config)# ntp allow 10.12.20.6 mask 255.255.255.0 vrf management	Configure the mask in the ntp allow list
(config)#commit	Commit the configuration
(config)# exit	Exit configure mode

NTP Client1

#configure terminal	Enter configure mode.
(config)# feature ntp vrf management	Enable feature ntp.
(config)# ntp enable vrf management	Enable ntp
(config)# ntp authenticate vrf management	Configure ntp client for authentication
(config)# ntp authentication-key 65 md5 test123 vrf management	Configure ntp authentication key with password
(config)# ntp trusted-key 65 vrf management	Configure ntp trusted key
(config)# ntp server 10.12.20.5 key 65 vrf management	Configure ntp server address for the sync to happen with authentication key
(config)#commit	Commit the configuration
(config)# exit	Exit Configure mode

NTP Client2

#configure terminal	Enter configure mode.
(config)# feature ntp vrf management	Enable feature ntp.
(config)# ntp enable vrf management	Enable ntp
(config)# ntp authenticate vrf management	Configure ntp client for authentication
(config)# ntp authentication-key 65 md5 test123 vrf management	Configure ntp authentication key with password
(config)# ntp trusted-key 65 vrf management	Configure ntp trusted key

(config)# ntp server 10.12.20.5 key 65 vrf management	Configure ntp server address for the sync to happen with authentication key
(config)#commit	Commit the configuration
(config)# exit	Exit Configure mode

Validation

Check the local clock synchronization in the NTP Master as mentioned below:

```
VTEP1#show ntp peer-status
  remote          refid          st t when poll reach  delay  offset  jitter
=====
*127.127.1.0      .LOCL.             1 l  64  64  377   0.000   0.000   0.000
Check the ntp client1 synchronization status as mentioned below:
#show ntp peer-status
Total peers : 1
* - selected for sync, + - peer mode(active),
- - peer mode(passive), = - polled in client mode,
x - source false ticker
  remote          refid          st t when poll reach  delay  offset  jitter
=====
*10.12.20.5      LOCAL(0)           2 u  12  64  377   0.185   0.002   0.006

Check the ntp client2 synchronization status as mentioned below :
VTEP2#show ntp peer-status
Total peers : 1
* - selected for sync, + - peer mode(active),
- - peer mode(passive), = - polled in client mode,
x - source false ticker
  remote          refid          st t when poll reach  delay  offset  jitter
=====
*10.12.20.5      LOCAL(0)           2 u  16  32  377   0.175  -0.360   0.226
```

User Defined VRF Configuration

NTP Master

#configure terminal	Enter configure mode
(config)# feature ntp vrf vrf1	Enable feature ntp
(config)# ntp enable vrf vrf1	Enable ntp
(config)# ntp master vrf vrf1	Configure the node as NTP master
(config)# ntp master stratum 1 vrf vrf1	Configure the ntp stratum level as 1 indicating that it is using local clock
(config)# ntp authenticate vrf vrf1	Configure ntp server for authentication
(config)# ntp authentication-key 1 md5 cisco 7 vrf vrf1	Configure ntp authentication key with password
(config)# ntp trusted-key 1 vrf vrf1	Configure ntp trusted key
(config)# ntp request-key 1 vrf vrf1	Configure request key
(config)# ntp allow 192.168.2.0 mask 255.255.255.0 vrf vrf1	Configure the mask in the ntp allow list for ipv4
(config)# ntp allow 2001:: mask 64 vrf vrf1	Configure the mask in the ntp a6llow list for ipv6
(config)# ntp allow 192.168.3.0 mask 255.255.255.0	Configure the mask in the ntp allow list for ipv4

vrf vrf1	
(config)# ntp allow 5001:: mask 64 vrf vrf1	Configure the mask in the ntp allow list for ipv6
(config)#commit	Commit the configuration
(config)# exit	Exit configure mode

NTP Client1

#configure terminal	Enter configure mode.
(config)# feature ntp vrf vrf1	Enable feature ntp.
(config)# ntp enable vrf vrf1	Enable ntp
(config)# ntp authenticate vrf vrf1	Configure ntp client for authentication
(config)# ntp authentication-key 1 md5 cisco vrf vrf1	Configure ntp authentication key with password
(config)# ntp request-key 1 vrf vrf1	Configure ntp trusted key
(config)# ntp trusted-key 1 vrf vrf1	Configure ntp trusted key
(config)# ntp server 192.168.2.2 key 1 vrf vrf1	Configure ntp server address for the sync to happen with authentication key
(config)#commit	Commit the configuration
(config)# exit	Exit Configure mode

NTP Client2

#configure terminal	Enter configure mode.
(config)# feature ntp vrf vrf1	Enable feature ntp.
(config)# ntp enable vrf vrf1	Enable ntp
(config)# ntp authenticate vrf vrf1	Configure ntp client for authentication
(config)# ntp authentication-key 1 md5 cisco vrf vrf1	Configure ntp authentication key with password
(config)# ntp request-key 1 vrf vrf1	Configure ntp trusted key
(config)# ntp trusted-key 1 vrf vrf1	Configure ntp trusted key
(config)# ntp server 192.168.3.2 key 1 vrf vrf1	Configure ntp server address for the sync to happen with authentication key
(config)#commit	Commit the configuration

Validation

Check the local clock synchronization in the NTP Master as mentioned below:

```
VTEP1#show ntp peer-status
  remote          refid          st t when poll reach  delay  offset  jitter
=====
*127.127.1.0     .LOCL.             1 1  50  64 377   0.000   0.000   0.000
```

Check the ntp client1 synchronization status as mentioned below:

```
#show ntp peer-status
```

```

Total peers : 2
* - selected for sync, + - peer mode(active),
- - peer mode(passive), = - polled in client mode,
x - source false ticker
  remote          refid          st t when poll reach  delay  offset  jitter
=====
*192.168.2.2     LOCAL(0)          2 u  43  64  377   0.407  -0.018  0.034
+2001::2        LOCAL(0)          2 u  22  64  377   0.432  -0.031  0.063

```

Check the ntp client2 synchronization status as mentioned below

```

#show ntp peer-status
Total peers : 2
* - selected for sync, + - peer mode(active),
- - peer mode(passive), = - polled in client mode,
x - source false ticker
  remote          refid          st t when poll reach  delay  offset  jitter
=====
*192.168.2.2     LOCAL(0)          2 u  43  64  377   0.407  -0.018  0.034
+2001::2        LOCAL(0)          2 u  22  64  377   0.432  -0.031  0.063

```

Synchronization of NTP Server and NTP Clients with NTP ACL

The command **nomodify ntp acl** signifies NTP Clients must be denied ntpq(1) and ntpdc(1) queries which attempt to modify the state of the server (i.e., run time reconfiguration). Queries which return information shall be permitted.

The command **noquery ntp acl** signifies Deny ntpq(1) and ntpdc(1) queries by NTP Clients. But Time service shall not be affected.

The command **nopeer ntp acl** signifies NTP Clients shall be denied access if unauthenticated packets which would result in mobilizing a new association is sent.

The command **notrap ntp acl** signifies NTP Clients shall be declined to provide mode 6 control message trap service to matching hosts. The trap service is a sub-system of the ntpq(1) control message protocol which is intended for use by remote event logging programs.

The command **KoD ntp acl** signifies When an access violation happens by NTP Clients, the server must send the KoD (kiss-o'-death) packets. KoD packets are rate limited to no more than one per second. If another KoD packet occurs within one second after the last one, the packet is dropped.

Topology

The procedures in this section use the topology as mentioned below:

Setup consists of three nodes. One node acting as NTP Master and the other two nodes acting as NTP Clients.

Figure 36. Synchronization of NTP Master and NTP Clients with NTP ACL

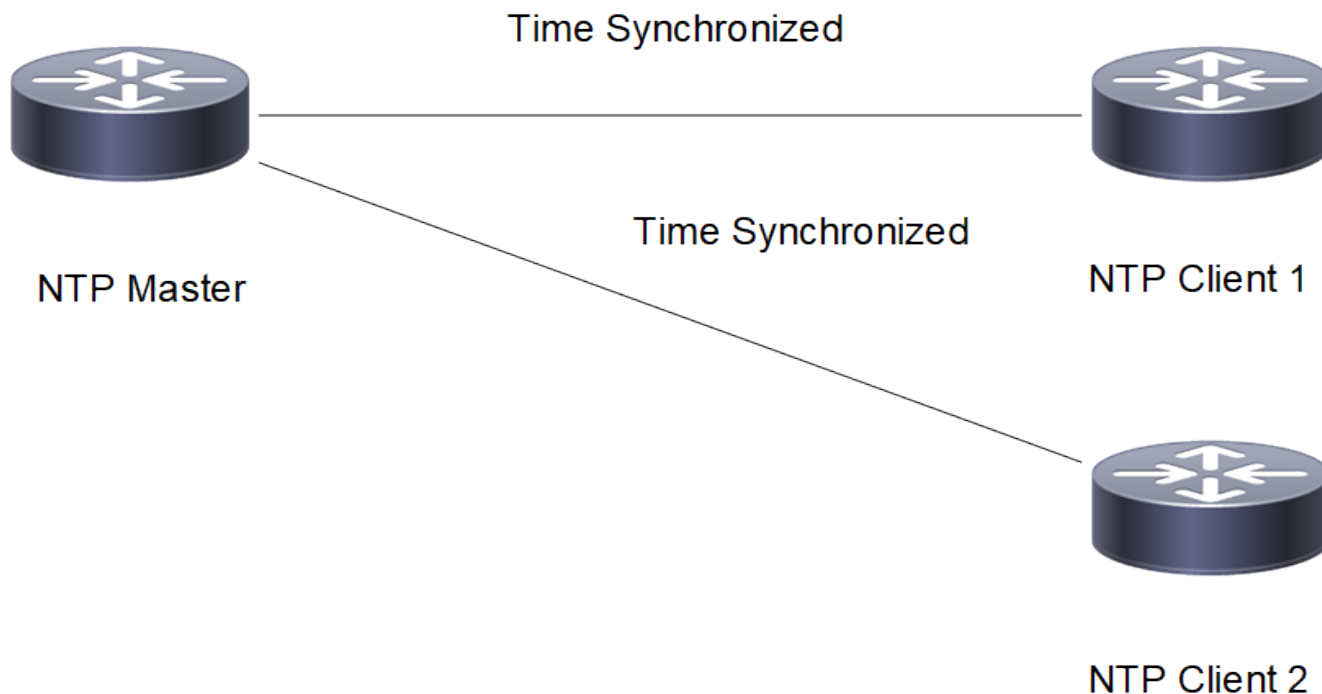

VRF Management Configuration

NTP Master

<code>#configure terminal</code>	Enter configure mode
<code>(config)# feature ntp vrf management</code>	Enable feature ntp
<code>(config)# ntp enable vrf management</code>	Enable ntp
<code>(config)# ntp master vrf management</code>	Configure the node as NTP master
<code>(config)# ntp master stratum 1 vrf management</code>	Configure the ntp stratum level as 1 indicating that it is using local clock
<code>(config)# ntp authenticate vrf management</code>	Configure ntp server for authentication
<code>(config)# ntp authentication-key 65 md5 test123 vrf management</code>	Configure ntp authentication key with password
<code>(config)# ntp trusted-key 65 vrf management</code>	Configure ntp trusted key
<code>(config)# ntp allow 10.12.20.6 mask 255.255.255.0 nomodify vrf management</code>	Configure the ntp acl nomodify in the ntp allow list
<code>(config)# ntp allow 10.12.20.6 mask 255.255.255.0 noquery vrf management</code>	Configure the ntp acl noquery in the ntp allow list
<code>(config)# ntp allow 10.12.20.6 mask 255.255.255.0 nopeer vrf management</code>	Configure the ntp acl nopeer in the ntp allow list
<code>(config)# ntp allow 10.12.20.6 mask 255.255.255.0 notrap vrf management</code>	Configure the ntp acl notrap in the ntp allow list
<code>(config)# ntp allow 10.12.20.6 mask 255.255.255.0 kod vrf management</code>	Configure the ntp acl KoD in the ntp allow list

(config)#commit	Commit the configuration
(config)# exit	Exit configure mode

NTP Client1

#configure terminal	Enter configure mode.
(config)# feature ntp vrf management	Enable feature ntp.
(config)# ntp enable vrf management	Enable ntp
(config)# ntp authenticate vrf management	Configure ntp client for authentication
(config)# ntp authentication-key 65 md5 test123 vrf management	Configure ntp authentication key with password
(config)# ntp trusted-key 65 vrf management	Configure ntp trusted key
(config)# ntp server 10.12.20.5 key 65 vrf management	Configure ntp server address for the sync to happen with authentication key
(config)#commit	Commit the configuration
(config)# exit	Exit Configure mode

NTP Client2

#configure terminal	Enter configure mode.
(config)# feature ntp vrf management	Enable feature ntp.
(config)# ntp enable vrf management	Enable ntp
(config)# ntp authenticate vrf management	Configure ntp client for authentication
(config)# ntp authentication-key 65 md5 test123 vrf management	Configure ntp authentication key with password
(config)# ntp trusted-key 65 vrf management	Configure ntp trusted key
(config)# ntp server 10.12.20.5 key 65 vrf management	Configure ntp server address for the sync to happen with authentication key
(config)#commit	Commit the configuration
(config)# exit	Exit Configure mode

Validation

Check the local clock synchronization in the NTP Master as mentioned below:



Note: Normal Time synchronization is not affected.

```
VTEP1#show ntp peer-status
  remote          refid          st t when poll reach  delay  offset  jitter
-----
*127.127.1.0     .LOCL.         1 1  40  64  377  0.000  0.000  0.000
VTEP1#
```

Check the ntp client1 synchronization status as mentioned below:

```
#show ntp peer-status
Total peers : 1
* - selected for sync, + - peer mode(active),
- - peer mode(passive), = - polled in client mode,
x - source false ticker
  remote          refid          st t when poll reach  delay  offset  jitter
=====
*10.12.20.5      LOCAL(0)          2 u  13  16  377   0.180   0.019   0.013
```

Check the ntp client2 synchronization status as mentioned below:

```
VTEP2#show ntp peer-status
Total peers : 1
* - selected for sync, + - peer mode(active),
- - peer mode(passive), = - polled in client mode,
x - source false ticker
  remote          refid          st t when poll reach  delay  offset  jitter
=====
*10.12.20.5      LOCAL(0)          2 u  15  16  377   0.185  -0.018   0.017
```

User Defined VRF Configuration

NTP Master

#configure terminal	Enter configure mode
(config)# feature ntp vrf vrf1	Enable feature ntp
(config)# ntp enable vrf vrf1	Enable ntp
(config)# ntp master vrf vrf1	Configure the node as NTP master
(config)# ntp master stratum 1 vrf vrf1	Configure the ntp stratum level as 1 indicating that it is using local clock
(config)# ntp authenticate vrf vrf1	Configure ntp server for authentication
(config)# ntp authentication-key 1 md5 cisco vrf vrf1	Configure ntp authentication key with password
(config)# ntp trusted-key 1 vrf vrf1	Configure ntp trusted key
(config)# ntp request-key 1 vrf vrf1	Configure ntp request key
(config)# ntp allow 192.168.2.0 mask 255.255.255.0 nomodify vrf vrf1	Configure the ntp acl nomodify in the ntp allow list
(config)# ntp allow 10.12.20.6 mask 255.255.255.0 noquery vrf management	Configure the ntp acl noquery in the ntp allow list
(config)# ntp allow 10.12.20.6 mask 255.255.255.0 nopeer vrf management	Configure the ntp acl nopeer in the ntp allow list
(config)# ntp allow 192.168.2.0 mask 255.255.255.0 noquery vrf vrf1	Configure the ntp acl notrap in the ntp allow list
(config)# ntp allow 192.168.2.0 mask 255.255.255.0 nopeer vrf vrf1	Configure the ntp acl nopeer in the ntp allow list
(config)# ntp allow 192.168.2.0 mask 255.255.255.0 notrap vrf vrf1	Configure the ntp acl notrap in the ntp allow list
(config)# ntp allow 10.12.20.6+-192.168.2.0 mask 255.255.255.0 kod vrf vrf1	Configure the ntp acl KoD in the ntp allow list
(config)#commit	Commit the configuration
(config)# exit	Exit configure mode

NTP Client1

#configure terminal	Enter configure mode.
(config)# feature ntp vrf vrf1	Enable feature ntp.
(config)# ntp enable vrf vrf1	Enable ntp
(config)# ntp authenticate vrf vrf1	Configure ntp client for authentication
(config)# ntp authentication-key 1 md5 cisco vrf vrf1	Configure ntp authentication key with password
(config)# ntp trusted-key 1 vrf vrf1	Configure ntp trusted key
(config)# ntp request-key 1 vrf vrf1	Configure ntp request key
(config)# ntp server 192.168.2.2 key 1 vrf vrf1	Configure ntp server address for the sync to happen with authentication key
(config)#commit	Commit the configuration
(config)# exit	Exit Configure mode

NTP Client2

#configure terminal	Enter configure mode.
(config)# feature ntp vrf vrf1	Enable feature ntp.
(config)# ntp enable vrf vrf1	Enable ntp
(config)# ntp authenticate vrf vrf1	Configure ntp client for authentication
(config)# ntp authentication-key 1 md5 cisco vrf vrf1	Configure ntp authentication key with password
(config)# ntp trusted-key 1 vrf vrf1	Configure ntp trusted key
(config)# ntp request-key 1 vrf vrf1	Configure ntp request key
(config)# ntp server 192.168.3.2 key 1 vrf vrf1	Configure ntp server address for the sync to happen with authentication key
(config)#commit	Commit the configuration

Validation

Check the local clock synchronization in the NTP Master as mentioned below:

Note: Normal Time synchronization is not affected.

```
VTEP1#show ntp peer-status
  remote          refid          st t when poll reach  delay  offset  jitter
=====
*127.127.1.0     .LOCL.             1 1  40  64  377   0.000   0.000   0.000
VTEP1#
```

Check the ntp client1 synchronization status as mentioned below:

```
#show ntp peer-status
Total peers : 1
* - selected for sync, + - peer mode(active),
```

```

- - peer mode(passive), = - polled in client mode,
x - source false ticker
  remote      refid      st t when poll reach  delay  offset  jitter
=====
*10.12.20.5   LOCAL(0)      2 u  13  16  377  0.180  0.019  0.013
    
```

Check the ntp client2 synchronization status as mentioned below:

```

VTEP2#show ntp peer-status
Total peers : 1
* - selected for sync, + - peer mode(active),
- - peer mode(passive), = - polled in client mode,
x - source false ticker
  remote      refid      st t when poll reach  delay  offset  jitter
=====
*10.12.20.5   LOCAL(0)      2 u  15  16  377  0.185  -0.018  0.017
    
```

Synchronization of NTP Server and NTP Clients with NTP ACL configured as noserve

The command `noserve ntp acl` signifies NTP Clients shall be denied all packets except `ntp(1)` and `ntpd(1)` queries.

Topology

The procedures in this section use the topology as mentioned below:

Setup consists of three nodes. One node acting as NTP Master and the other two nodes acting as NTP Clients.

Figure 37. Synchronization of NTP Master and NTP Clients with NTP ACL as noserve

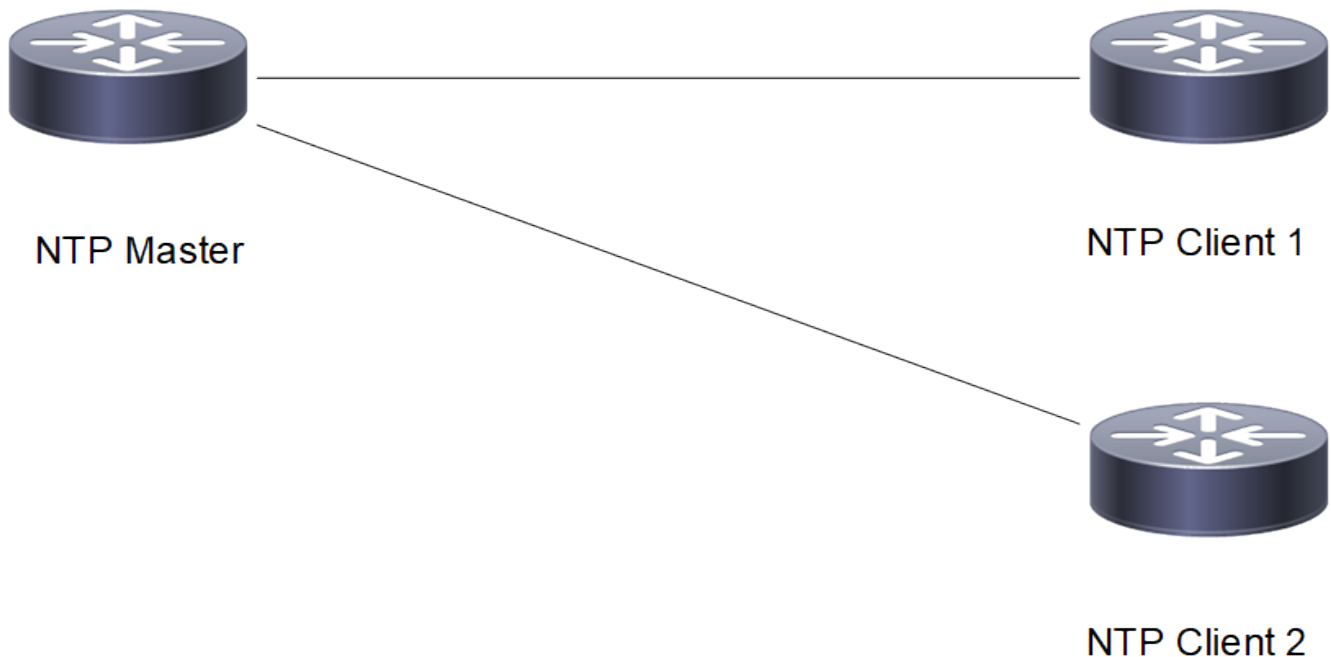

VRF Management Configuration

NTP Master

#configure terminal	Enter configure mode
(config)# feature ntp vrf management	Enable feature ntp
(config)# ntp enable vrf management	Enable ntp
(config)# ntp master vrf management	Configure the node as NTP master
(config)# ntp master stratum 1 vrf management	Configure the ntp stratum level as 1 indicating that it is using local clock
(config)# ntp authenticate vrf management	Configure ntp server for authentication
(config)# ntp authentication-key 65 md5 test123 vrf management	Configure ntp authentication key with password
(config)# ntp trusted-key 65 vrf management	Configure ntp trusted key
(config)# ntp allow 10.12.20.6 mask 255.255.255.0 noserve vrf management	Configure the ntp acl noserve in the ntp allow list
(config)#commit	Commit the configuration
(config)# exit	Exit configure mode

NTP Client1

#configure terminal	Enter configure mode.
(config)#feature ntp vrf management	Enable feature ntp.
(config)#ntp enable vrf management	Enable ntp
(config)#ntp authenticate vrf management	Configure ntp client for authentication
(config)#ntp authentication-key 65 md5 test123 vrf management	Configure ntp authentication key with password
(config)#ntp trusted-key 65 vrf management	Configure ntp trusted key
(config)#ntp server 10.12.20.5 key 65 vrf management	Configure ntp server address for the sync to happen with authentication key
(config)#commit	Commit the configuration
(config)#exit	Exit Configure mode

NTP Client2

#configure terminal	Enter configure mode.
(config)#feature ntp vrf management	Enable feature ntp.
(config)#ntp enable vrf management	Enable ntp
(config)#ntp authenticate vrf management	Configure ntp client for authentication
(config)#ntp authentication-key 65 md5 test123 vrf management	Configure ntp authentication key with password
(config)#ntp trusted-key 65 vrf management	Configure ntp trusted key

(config)#ntp server 10.12.20.5 key 65 vrf management	Configure ntp server address for the sync to happen with authentication key
(config)#commit	Commit the configuration
(config)#exit	Exit Configure mode

Validation

Check that with NTP acl configured as noserve, Normal Time synchronization is affected and there is no synchronization.

Check the local clock synchronization in the NTP Master as mentioned below

```
VTEP1#show ntp peer-status
  remote          refid          st t when poll reach  delay  offset  jitter
=====
*127.127.1.0     .LOCL.           1 1  41  64  377  0.000  0.000  0.000
```

Check the ntp client1 synchronization status as mentioned below

```
#show ntp peer-status
Total peers : 1
* - selected for sync, + - peer mode(active),
- - peer mode(passive), = - polled in client mode,
x - source false ticker
  remote          refid          st t when poll reach  delay  offset  jitter
=====
  10.12.20.5     .INIT.          16 u  -  64  0  0.000  0.000  0.000
```

Check the ntp client2 synchronization status as mentioned below

```
VTEP2#show ntp peer-status
Total peers : 1
* - selected for sync, + - peer mode(active),
- - peer mode(passive), = - polled in client mode,
x - source false ticker
  remote          refid          st t when poll reach  delay  offset  jitter
=====
  10.12.20.5     .INIT.          16 u  -  64  0  0.000  0.000  0.000
```

User Defined VRF Configuration

NTP Master

#configure terminal	Enter configure mode
(config)# feature ntp vrf vrf1	Enable feature ntp
(config)# ntp enable vrf vrf1	Enable ntp
(config)# ntp master vrf vrf1	Configure the node as NTP master
(config)# ntp master stratum 1 vrf vrf1	Configure the ntp stratum level as 1 indicating that it is using local clock
(config)# ntp authenticate vrf vrf1	Configure ntp server for authentication
(config)# ntp authentication-key 65 md5 test123 vrf vrf1	Configure ntp authentication key with password
(config)# ntp trusted-key 65 vrf vrf1	Configure ntp trusted key
(config)# ntp allow 10.12.20.6 mask 255.255.255.0	Configure the ntp acl noserve in the ntp allow list

<code>noserve vrf vrf1</code>	
<code>(config)#commit</code>	Commit the configuration
<code>(config)# exit</code>	Exit configure mode

NTP Client1

<code>#configure terminal</code>	Enter configure mode.
<code>(config)#feature ntp vrf vrf1</code>	Enable feature ntp.
<code>(config)#ntp enable vrf vrf1</code>	Enable ntp
<code>(config)#ntp authenticate vrf vrf1</code>	Configure ntp client for authentication
<code>(config)ntp authentication-key 65 md5 test123 vrf vrf1</code>	Configure ntp authentication key with password
<code>(config)#ntp ntp trusted-key 65 vrf vrf1</code>	Configure ntp trusted key
<code>(config)#ntp server 10.12.20.5 key 65 vrf vrf1</code>	Configure ntp server address for the sync to happen with authentication key
<code>(config)#commit</code>	Commit the configuration
<code>(config)#exit</code>	Exit Configure mode

NTP Client2

<code>#configure terminal</code>	Enter configure mode.
<code>(config)#feature ntp vrf vrf1</code>	Enable feature ntp.
<code>(config)#ntp enable vrf vrf1</code>	Enable ntp
<code>(config)#ntp authenticate vrf vrf1</code>	Configure ntp client for authentication
<code>(config)#ntp authentication-key 65 md5 test123 vrf vrf1</code>	Configure ntp authentication key with password
<code>(config)#ntp trusted-key 65 vrf vrf1</code>	Configure ntp trusted key
<code>(config)#ntp server 10.12.20.5 key 65 vrf vrf1</code>	Configure ntp server address for the sync to happen with authentication key
<code>(config)#commit</code>	Commit the configuration
<code>(config)#exit</code>	Exit Configure mode

Validation

Check that with NTP acl configured as noserve, Normal Time synchronization is affected and there is no synchronization.

Check the local clock synchronization in the NTP Master as mentioned below

```
VTEP1#show ntp peer-status
  remote          refid          st t when poll reach  delay  offset  jitter
=====
*127.127.1.0     .LOCL.             1 1  41  64  377   0.000   0.000   0.000
```

Check the ntp client1 synchronization status as mentioned below

```
#show ntp peer-status
```

```
Total peers : 1
* - selected for sync, + - peer mode(active),
- - peer mode(passive), = - polled in client mode,
x - source false ticker
  remote          refid          st t when poll reach  delay  offset  jitter
=====
10.12.20.5        .INIT.          16 u   -   64   0   0.000   0.000   0.000
```

Check the ntp client2 synchronization status as mentioned below

```
VTEP2#show ntp peer-status
Total peers : 1
* - selected for sync, + - peer mode(active),
- - peer mode(passive), = - polled in client mode,
x - source false ticker
  remote          refid          st t when poll reach  delay  offset  jitter
=====
10.12.20.5        .INIT.          16 u   -   64   0   0.000   0.000   0.000
```

Synchronization of NTP Client with Stratum 2 NTP Master

In the below section, check Synchronization of NTP Client with Stratum 2 NTP Master.

Topology

The procedures in this section use the topology as mentioned below:

Setup consists of three nodes. First node acting as Stratum 1 NTP Master, Second node acting as Stratum 2 NTP master and the third node acting as NTP client.

Figure 38. Synchronization of Stadium 2 NTP Master with NTP Client

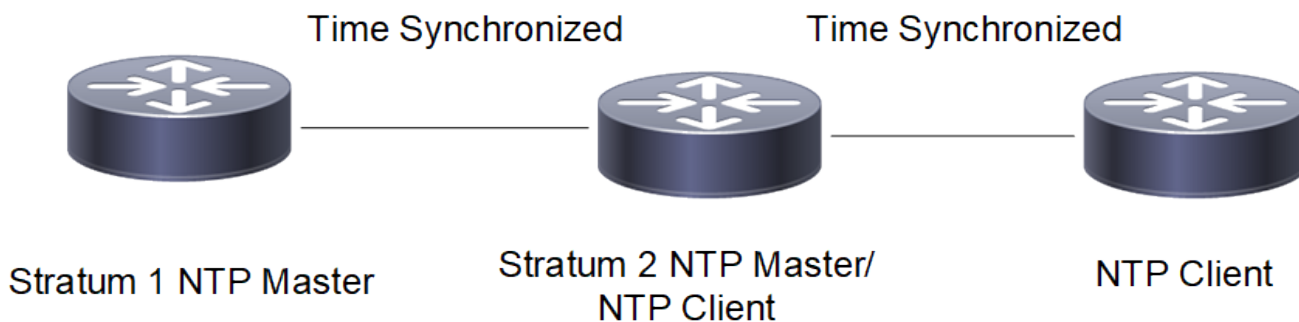

Management VRF Configuration

Stratum 1 NTP Master

#configure terminal	Enter configure mode
(config)#feature ntp vrf management	Enable feature ntp
(config)#ntp enable vrf management	Enable ntp
(config)#ntp master vrf management	Configure the node as NTP master
(config)#ntp master stratum 1 vrf management	Configure the ntp stratum level as 1 indicating that it

	is using local clock
(config)#ntp allow 10.12.20.5 vrf management	Configure the ntp client ip address in the ntp allow list
(config)#commit	Commit the configuration
(config)#exit	Exit configure mode

Stratum 2 NTP Server/NTP Client

#configure terminal	Enter configure mode.
(config)#feature ntp vrf management	Enable feature ntp.
(config)#ntp enable vrf management	Enable ntp
(config)#ntp master vrf management	Configure the node as NTP Master
(config)#ntp master stratum 2 vrf management	Configure the node as stratum 2 ntp master
(config)#ntp allow 10.12.20.6 vrf management	Configure NTP client ip address in the ntp allow list
(config)#ntp server 10.12.20.7 vrf management	Configure the stratum 1 NTP master ip address for time synchronization
(config)#commit	Commit the configuration
(config)#exit	Exit Configure mode

NTP Client

#configure terminal	Enter configure mode.
(config)#feature ntp vrf management	Enable feature ntp.
(config)#ntp enable vrf management	Enable ntp
(config)#ntp server 10.12.20.5 vrf management	Configure ntp server address for the sync to happen
(config)#commit	Commit the configuration
(config)#exit	Exit Configure mode

Validation

Check that NTP Client successfully synchronizes the time with stratum 2 NTP Master.

Check the local clock synchronization in the Stratum 1 NTP Master as mentioned below:

Use this for Command syntax, and Validation code snippets.

To use:

Insert this snippet where you want the code block to be.

Right click and select convert to text.

Copy the code you want to insert.

Right click on the block and select Edit Code Snippet to open the editor.

Paste the code and click OK in the bottom right.

Check the Stratum 2 NTP Master/NTP client synchronization status as mentioned below:

```
VTEP1#show ntp peer-status
Total peers : 1
* - selected for sync, + - peer mode(active),
-- peer mode(passive), = - polled in client mode,
x - source false ticker
      remote          refid          st t when poll reach  delay  offset  jitter
```



```
=====
*10.12.20.7      LOCAL(0)      2 u  33  64  377  0.145  0.010  0.009
127.127.1.0     .LOCL.             2 l 110m 64   0   0.000  0.000  0.000
=====
```

Check the NTP Client synchronization status as mentioned below:

Use this for Command syntax, and Validation code snippets.

To use:

Insert this snippet where you want the code block to be.

Right click and select convert to text.

Copy the code you want to insert.

Right click on the block and select Edit Code Snippet to open the editor.

Paste the code and click OK in the bottom right.

User Defined VRF Configuration

Stratum 1 NTP Master

#configure terminal	Enter configure mode
(config)#feature ntp vrf vrf1	Enable feature ntp
(config)#ntp enable vrf vrf1	Enable ntp
(config)#ntp master vrf vrf1	Configure the node as NTP master
(config)#ntp master stratum 1 vrf vrf1	Configure the ntp stratum level as 1 indicating that it is using local clock
(config)#ntp allow 192.168.3.0 vrf vrf1	Configure the ntp client ip address in the ntp allow list
(config)#commit	Commit the configuration
(config)#exit	Exit configure mode

Stratum 2 NTP Server/NTP Client

#configure terminal	Enter configure mode.
(config)#feature ntp vrf management	Enable feature ntp.
(config)#ntp enable vrf management	Enable ntp
(config)#ntp master vrf management	Configure the node as NTP Master
(config)#ntp master stratum 2 vrf management	Configure the node as stratum 2 ntp master
(config)#ntp allow 10.12.20.6 vrf management	Configure NTP client ip address in the ntp allow list
(config)#ntp server 10.12.20.7 vrf management	Configure the stratum 1 NTP master ip address for time synchronization
(config)#commit	Commit the configuration
(config)#exit	Exit Configure mode

NTP Client

#configure terminal	Enter configure mode.
(config)#feature ntp vrf management	Enable feature ntp.
(config)#ntp enable vrf management	Enable ntp

(config)#ntp server 10.12.20.5 vrf management	Configure ntp server address for the sync to happen
(config)#commit	Commit the configuration
(config)#exit	Exit Configure mode

Validation

Check that NTP Client successfully synchronizes the time with stratum 2 NTP Master.

Check the local clock synchronization in the Stratum 1 NTP Master as mentioned below:

```
VTEP2#show ntp peer-status
  remote          refid          st t when poll reach  delay  offset  jitter
=====
*127.127.1.0     .LOCL.             1 1  22  64  377   0.000   0.000   0.000
```

Check the Stratum 2 NTP Master/NTP client synchronization status as mentioned below:

```
VTEP1#show ntp peer-status
Total peers : 1
* - selected for sync, + - peer mode(active),
- - peer mode(passive), = - polled in client mode,
x - source false ticker
  remote          refid          st t when poll reach  delay  offset  jitter
=====
*10.12.20.7     LOCAL(0)         2 u  33  64  377   0.145   0.010   0.009
 127.127.1.0     .LOCL.             2 1 110m 64   0   0.000   0.000   0.000
```

Check the NTP Client synchronization status as mentioned below:

```
#show ntp peer-status
Total peers : 1
* - selected for sync, + - peer mode(active),
- - peer mode(passive), = - polled in client mode,
x - source false ticker
  remote          refid          st t when poll reach  delay  offset  jitter
=====
*10.12.20.5     10.12.20.7       3 u  16  64  377   0.137  -2.596   0.235
```

| NTP COMMAND REFERENCE

Network Time Protocol	533
clear ntp statistics	533
debug ntp	534
feature ntp	535
ntp acl	535
ntp authenticate	537
ntp authentication-key	538
ntp enable	538
ntp discard	539
ntp logging	540
ntp master	541
ntp master stratum	541
ntp peer	542
ntp request-key	543
ntp server	544
ntp sync-retry	546
ntp trusted-key	546
show ntp authentication-keys	547
show ntp authentication-status	548
show ntp logging-status	548
show ntp peer-status	549
show ntp peers	550
show ntp statistics	551
show ntp trusted-keys	553
show running-config ntp	553

Network Time Protocol

This chapter is a reference for Network Time Protocol (NTP) commands.

NTP synchronizes clocks between computer systems over packet-switched networks. NTP can synchronize all participating computers to within a few milliseconds of Coordinated Universal Time (UTC).

NTP uses a hierarchical, layered system of time sources. Each level of this hierarchy is called a “stratum” and is assigned a number starting with zero at the top. The number represents the distance from the reference clock and is used to prevent cyclical dependencies in the hierarchy.



Note: The default time-to-live value for the unicast packets is 64.

This chapter contains these commands:

clear ntp statistics	533
debug ntp	534
feature ntp	535
ntp acl	535
ntp authenticate	537
ntp authentication-key	538
ntp enable	538
ntp discard	539
ntp logging	540
ntp master	541
ntp master stratum	541
ntp peer	542
ntp request-key	543
ntp server	544
ntp sync-retry	546
ntp trusted-key	546
show ntp authentication-keys	547
show ntp authentication-status	548
show ntp logging-status	548
show ntp peer-status	549
show ntp peers	550
show ntp statistics	551
show ntp trusted-keys	553
show running-config ntp	553

clear ntp statistics

Use this command to reset NTP statistics.

Command Syntax

```
clear ntp statistics (all-peers | io | local | memory)
```

Parameters

all-peers

Counters associated with all peers

io

Counters maintained in the input-output module

local

Counters maintained in the local protocol module

memory

Counters related to memory allocation

Command Mode

Execution mode and Privileged execution mode

Applicability

This command was introduced before OcNOS version 1.3.

Example

```
#clear ntp statistics all-peers
```

debug ntp

Use this command to display NTP debugging messages.

Use the **no** form of this command to stop displaying NTP debugging messages.

Command Syntax

```
debug ntp  
no debug ntp
```

Parameters

None

Command Mode

Execution mode and Configure mode

Applicability

This command was introduced before OcNOS version 1.3.

Examples

```
#configure terminal
(config)#debug ntp

(config)#no debug ntp
```

feature ntp

Use this command to enable to NTP feature.

Use the **no** form of this command to disable NTP feature and delete all the NTP related configurations.

Command Syntax

```
feature ntp ( (NAME|management)|)
no feature ntp ( (NAME|management)|)
```

Parameters

vrf management

Defines the management **VRF**¹ instance.

vrf NAME

Specify the user-defined VRF instance name.

Default

By default, feature ntp is enabled.

Command Mode

Configure mode

Applicability

This command was introduced before OcNOS version 1.3. Added **VRF NAME** parameter in OcNOS version 6.5.3

Examples

```
#configure terminal
(config)#feature ntp vrf management

(config)#no feature ntp vrf management
```

ntp acl

Use this command to allow particular client to communicate with NTP server.

Use the **no** form of this command to remove the particular client from NTP server.

¹Virtual Routing and Forwarding



Note: [ntp discard \(page 539\)](#) option and limited rate flag are required for sending the KOD packet.

Command Syntax

```
ntp allow (A.B.C.D | X:X::X:X) (mask (A.B.C.D| <1-128>)|)
({nopeer|noserve|noquery|nomodify|kod|limited|notrap|}) (NAME|management|)
no ntp allow (A.B.C.D | X:X::X:X) (mask (A.B.C.D| <1-128>)|)
({nopeer|noserve|noquery|nomodify|kod|limited|notrap|}) (NAME|management|)
```

Parameters

A.B.C.D

IPv4 address of the client

X:X::X:X

IPv6 address of the client

A.B.C.D

Mask for the IPv4 address

1-128

Mask for the IPv6 address

nopeer

Prevent the client from establishing a peer association

noserve

Prevent the client from performing time queries

noquery

Prevent the client from performing NTPq and NTPdc queries, but not time queries

nomodify

Restrict the client from making any changes to the NTP configurations

kod

Send a kiss-of-death packet if the client limit has exceeded

limited

Deny time service if the packet violates the rate limits established by the discard command

notrap

Prevent the client from configuring control message traps

vrf

Virtual Router and Forwarding

vrf management

Defines the management **VRF**¹ instance.

vrf NAME

Specify the user-defined VRF instance name.

Default

By default, only local host is permitted.

¹Virtual Routing and Forwarding

Command Mode

Configure mode

Applicability

This command is introduced in OcNOS version 4.1. Added VRF NAME parameter in OcNOS version 6.5.3.

Example

```
#configure terminal
(config)#ntp allow 1.1.1.1 mask 255.255.255.0 nopeer kod notrap noserve vrf management
```

ntp authenticate

Use this command to enable NTP authentication.

Use the **no** form of this command to disable authentication.

Command Syntax

```
ntp authenticate ((NAME|management)|)
no ntp authenticate ((NAME|management)|)
```

Parameters

management

Virtual Routing and Forwarding name

vrf management

Defines the management **VRF**¹ instance.

vrf NAME

Specify the user-defined VRF instance name.

Default

Disabled

Command Mode

Configure mode

Applicability

This command was introduced before OcNOS version 1.3. Added VRF NAME parameter in OcNOS version 6.5.3.

Example

```
#configure terminal
(config)#ntp authenticate vrf management
```

¹Virtual Routing and Forwarding

ntp authentication-key

Use this command to set an NTP Message Digest Algorithm 5 (MD5) authentication key.

Use the **no** form of this command to delete an authentication key.

Command Syntax

```
ntp authentication-key <1-65534> md5 WORD ((NAME|management)|)
ntp authentication-key <1-65534> md5 WORD 7 ((NAME|management)|)
no ntp authentication-key <1-65534> md5 WORD ((NAME|management)|)
```

Parameters

<1-65534>

Authentication key number

vrf management

Defines the management **VRF**¹ instance.

vrf NAME

Specify the user-defined VRF instance name.

Default

None

Command Mode

Configure mode

Applicability

This command was introduced before OcNOS version 1.3. Added VRF NAME parameter in OcNOS version 6.5.3.

Example

```
#configure terminal
(config)#ntp authentication-key 535 md5 J@u-b;12 vrf management
```

ntp enable

Use this command to enable NTP feature and start the NTP service.

Use the **no** form of this command to stop the NTP service.

Command Syntax

```
ntp enable ( (NAME|management)|)
no ntp enable ( (NAME|management)|)
```

¹Virtual Routing and Forwarding

Parameters

vrf management

Defines the management VRF¹ instance.

vrf NAME

Specify the user-defined VRF instance name.

Default

By default, ntp is enabled.

Command Mode

Configure mode

Applicability

This command was introduced before OcNOS version 1.3. Added VRF NAME parameter in OcNOS version 6.5.3

Example

```
#configure terminal
(config)#ntp enable vrf management
```

ntp discard

Use this command to enable rate limiting access to the NTP service running on a system.

Use the no form of this command to disable rate limiting access to the NTP service running on a system.

This NTP discard option and limited rate flag are required for sending the KOD packet. KOD (Kiss of Death) packets have the leap bits set unsynchronized and stratum set to zero and the reference identifier field set to a four-byte ASCII code. If the noserve or notrust flag of the matching restrict list entry is set, the code is "DENY"; if the limited flag is set and the rate limit is exceeded, the code is "RATE".

Command Syntax

```
ntp discard minimum <1-65535> (vrf management|)
no ntp discard minimum (vrf management|)
```

Command Syntax

minimum

Specify the minimum interpacket spacing <default 2>

<0-65535>

Minimum value

Default

By default, the minimum value is 2.

¹Virtual Routing and Forwarding

Command Mode

Configure mode

Applicability

This command is introduced in OcNOS version 4.2.

Example

```
#configure terminal
(config)#ntp discard minimum 50 vrf management
```

ntp logging

Use this command to log NTP events.

Use the **no** form of this command to disable NTP logging.

Command Syntax

```
ntp logging ( (NAME|management)|)
no ntp logging ( (NAME|management)|)
```

Parameters

vrf management

Defines the management **VRF**¹ instance.

vrf NAME

Specify the user-defined VRF instance name.

Default

By default, ntp logging message is disabled

Command Mode

Configure mode

Applicability

This command was introduced before OcNOS version 1.3. Added VRF NAME parameter in OcNOS version 6.5.3

Example

```
#configure terminal
(config)#ntp logging vrf management
```

¹Virtual Routing and Forwarding

ntp master

Use this command to run a device as an NTP server.

Use the `no` command to disable the NTP server.

Command Syntax

```
ntp master ( (NAME|management) | )  
no ntp master ( (NAME|management) | )
```

Parameters

vrf management

Defines the management **VRF**¹ instance.

vrf NAME

Specify the user-defined VRF instance name.

Default

By default, NTP master is disabled

Command Mode

Configure mode

Applicability

This command is introduced in OcNOS version 4.1. Added VRF NAME parameter in OcNOS version 6.5.3

Example

```
#configure terminal  
(config)#ntp master vrf management
```

ntp master stratum

Use this command to set stratum value for NTP server.

Use the `no` command to remove stratum value.

The NTP Stratum model is a representation of the hierarchy of time servers in an NTP network, where the Stratum level (0-15) indicates the device's distance to the reference clock.

Command Syntax

```
ntp master stratum <1-15> ( (NAME|management) | )  
no ntp master stratum <1-15> ( (NAME|management) | )
```

¹Virtual Routing and Forwarding

Parameters

<1-15>

Stratum value for NTP server

vrf

Virtual Router and Forwarding

vrf management

Defines the management VRF¹ instance.

vrf NAME

Specify the user-defined VRF instance name.

Default

16

Command Mode

Configure mode

Applicability

This command is introduced in OcNOS version 4.1. Added VRF NAME parameter in OcNOS version 6.5.3.

Example

```
#configure terminal
(config)#ntp master stratum 2 vrf management
```

ntp peer

Use this command to configure a peer association. In a peer association, this system can synchronize with the other system or the other system can synchronize with this system.

Use the **no** command to remove a peer association.

Command Syntax

```
ntp peer (A.B.C.D | HOSTNAME) ({prefer|key <1-65534>|minpoll <4-16>|maxpoll <4-16>}) (vrf management|)
ntp peer (A.B.C.D | X:X::X:X | HOSTNAME) ({prefer|key <1-65534>|minpoll <4-16>|maxpoll <4-16>}) (vrf
management|)
no ntp peer (A.B.C.D | HOSTNAME) ({prefer|key <1-65534>|minpoll <4-16>|maxpoll <4-16>}) (vrf
management|)
no ntp peer (A.B.C.D | HOSTNAME) ({prefer|key|minpoll|maxpoll}) (vrf management|)
no ntp peer (A.B.C.D | X:X::X:X | HOSTNAME) ({prefer|key <1-65534>|minpoll <4-16>|maxpoll <4-16>}) (vrf
management|)
no ntp peer (A.B.C.D | X:X::X:X | HOSTNAME) ({prefer|key|minpoll|maxpoll}) (vrf management|)
```

Parameters

A.B.C.D

IPv4 address of peer

¹Virtual Routing and Forwarding

HOSTNAME

Host name of peer

X:X::X:X

IPv6 address of peer

prefer

Prefer this peer; preferred peer responses are discarded only if they vary dramatically from other time sources

key

Peer authentication key

<1-65534>

Peer authentication key value

minpoll

Minimum poll interval

<4-16>

Minimum poll interval value in seconds raised to a power of 2 (default 4 = 16 seconds)

maxpoll

Maximum poll interval

<4-16>

Maximum poll interval value in seconds raised to a power of 2 (default 6 = 64 seconds)

management

Virtual Routing and Forwarding name

Default

By default, value of **minpoll** is 4 and **maxpoll** is 6.

Command Mode

Configure mode

Applicability

This command was introduced before OcNOS version 1.3.

Examples

```
#configure terminal
(config)#ntp peer 10.10.0.23 vrf management
(config)#ntp peer 10.10.0.23 prefer key 12345 vrf management

(config)#no ntp peer 10.10.0.23 vrf management
```

ntp request-key

Use this command to define NTP request-key which is used by the NTPDC utility program. NTP client should be able to modify NTP server configuration by using this request-key. Request key must be a trusted key.

Use **no** form of this command to remove a request key.

Command Syntax

```
ntp request-key <1-65534> ((NAME|management)|)
no ntp request-key <1-65534> ((NAME|management)|)
```

Parameter

<1-65534>

Request key number

vrf management

Defines the management VRF¹ instance.

vrf NAME

Specify the user-defined VRF instance name.

Default

None

Command Mode

Configure mode

Applicability

This command is introduced in OcNOS version 5.1 MR. Added VRF NAME parameter in OcNOS version 6.5.3.

Example

```
#configure terminal
(config)#ntp request-key 123 vrf management
t
```

ntp server

Use this command to configure an NTP server so that this system synchronizes with the server, but not vice versa.

Use the **no** option with this command to remove an NTP server.

Command Syntax

```
ntp server (A.B.C.D | HOSTNAME) ({prefer|key <1-65534>|minpoll <4-16>|maxpoll <4-16>|})
(NAME|management) |
ntp server (A.B.C.D | X::X::X:X | HOSTNAME) ({prefer|key <1-65534>|minpoll <4-16>|maxpoll <4-16>|})
(NAME|management) |
no ntp server (A.B.C.D | HOSTNAME) ({prefer|key <1-65534>|minpoll <4-16>|maxpoll <4-16>|}) (vrf
management) |
no ntp server (A.B.C.D | HOSTNAME) ({prefer|key|minpoll|maxpoll|}) (NAME|management) |
no ntp server (A.B.C.D | X::X::X:X | HOSTNAME) ({prefer|key <1-65534>|minpoll <4-16>|maxpoll <4-16>|})
(NAME|management) |
no ntp server (A.B.C.D | HOSTNAME) ({prefer|key|minpoll|maxpoll|}) (NAME|management)
```

¹Virtual Routing and Forwarding

Parameters

A.B.C.D

IPv4 address of the server

HOSTNAME

Host name of the server

X:X::X:X

IPv6 address of the server

prefer

Prefer this server; preferred server responses are discarded only if they vary dramatically from other time sources

key

Server authentication key

<1-65534>

Server authentication key

minpoll

Minimum poll interval

<4-16>

Minimum poll interval value in seconds raised to a power of 2 (default 4 = 16 seconds)

maxpoll

Maximum poll interval

<4-16>

Maximum poll interval value in seconds raised to a power of 2 (default 6 = 64 seconds)

vrf management

Defines the management **VRF**¹ instance.

vrf NAME

Specify the user-defined VRF instance name.

Default

By default, **minpoll** is 4 and **maxpoll** is 6.

Command Mode

Configure mode

Applicability

This command was introduced before OcNOS version 1.3. Added VRF NAME parameter in OcNOS version 6.5.3.

Examples

```
#configure terminal
(config)#ntp server 10.10.0.23 vrf management
(config)#ntp server 10.10.0.23 prefer key 12345 vrf management

(config)#no ntp server 10.10.0.23 vrf management
```

¹Virtual Routing and Forwarding

ntp sync-retry

Use this command to retry NTP synchronization with configured servers.

Command Syntax

```
ntp sync-retry vrf (NAME|management) |)
```

Parameter

vrf management

Defines the management **VRF**¹ instance.

vrf NAME

Specify the user-defined VRF instance name.

Default

None

Command Mode

Execution mode

Applicability

This command was introduced before OcNOS version 1.3. Added VRF NAME parameter in OcNOS version 6.5.3.

Example

```
#configure terminal
#ntp sync-retry vrf management
```

ntp trusted-key

Use this command to define a “trusted” authentication key. If a key is trusted, the device will synchronize with a system that specifies this key in its NTP packets.

Use the **no** option with this command to remove a trusted key.

Command Syntax

```
ntp trusted-key <1-65534> ((NAME|management) |)
no ntp trusted-key <1-65534> ((NAME|management) |)
```

Parameter

<1-65534>

Authentication key number

¹Virtual Routing and Forwarding

vrf management

Defines the management **VRF**¹ instance.

vrf NAME

Specify the user-defined VRF instance name.

Default

By default, ntp trusted key is disabled

Command Mode

Configure mode

Applicability

This command was introduced before OcNOS version 1.3. A Added VRF NAME parameter in OcNOS version 6.5.3.

Example

```
#configure terminal
(config)#ntp trusted-key 234676 vrf management
```

show ntp authentication-keys

Use this command to display authentication keys.

Command Syntax

```
show ntp authentication-keys
```

Parameters

None

Command Mode

Execution mode and Privileged execution mode

Applicability

This command was introduced before OcNOS version 1.3.

Example

```
#sh ntp authentication-keys
-----
Auth Key MD5 String
-----
123 0xa2cb891442844220
#
```

¹Virtual Routing and Forwarding

[Table 22](#)**Table 22. show ntp authentication-key fields**

Entry	Description
Auth key	Authentication key (password). Use the password to verify the authenticity of packets sent from this interface or peer interface.
MD5 String	One or more MD5 key strings. The MD5 key values can be from 1 through 16 characters long. You can specify more than one key value within the list.

show ntp authentication-status

Use this command to display whether authentication is enabled or disabled.

Command Syntax

```
show ntp authentication-status
```

Parameters

None

Command Mode

Execution mode and Privileged execution mode

Applicability

This command was introduced before OcNOS version 1.3.

Example

```
#show ntp authentication-status  
Authentication enabled
```

show ntp logging-status

Use this command to display the NTP logging status.

Command Syntax

```
show ntp logging-status
```

Parameters

None

Command Mode

Execution mode and Privileged execution mode

Applicability

This command was introduced before OcNOS version 1.3.

Example

```
#show ntp logging-status
NTP logging enabled
```

show ntp peer-status

Use this command to display the peers for which the server is maintaining state along with a summary of that state.

Command Syntax

```
show ntp peer-status
```

Parameters

None

Command Mode

Execution mode and Privileged execution mode

Applicability

This command was introduced before OcNOS version 1.3.

Example

```
#sh ntp peer-status
Total peers : 1
* - selected for sync, + - peer mode(active),
- - peer mode(passive), = - polled in client mode,
x - source false ticker
remote refid st t when poll reach delay offset jitter
=====
*216.239.35.4 .GOOG. 1 u 24 64 377 38.485 0.149 0.053
#
```

[Table 23](#) explains the output fields.

Table 23. show ntp peer-status fields

Entry	Description
Total peers	Number of servers and peers configured.
* - selected for sync, + - peer mode (active), - - peer mode (passive), = - polled in client mode x - source false ticker	Fate of this peer in the clock selection process.

Table 23. show ntp peer-status fields (continued)

Entry	Description
Remote	Address of the remote peer.
refid	Reference ID (0.0.0.0 for an unknown reference ID).
st	The stratum of the remote peer (a stratum of 16 indicated remote peer is unsynchronized).
t	Type of peer (local, unicast, multicast and broadcast).
when	Time the last packet was received.
poll	The polling interval (seconds).
reach	The reachability register (octal).
delay	Current estimated delay in seconds.
offset	Current estimated offset in seconds.
jitter	Current dispersion of the peer in seconds.

show ntp peers

Use this command to display NTP peers.



Note: The commands "show ntp statistics" and "show ntp peer-status" do not produce output when both IPv6 and IPv4 ACL rules, configured with `deny udp any any eq ntp`, are applied to the **line vty**.

Command Syntax

```
show ntp peers
```

Parameters

None

Command Mode

Execution mode and Privileged execution mode

Applicability

This command was introduced before OcNOS version 1.3.

Example

```
#show ntp peers
-----
Peer IP Address Serv/Peer
-----
216.239.35.4 Server (configured)
```

[Table 24](#) explains the output fields.

Table 24. show ntp peers fields

Entry	Description
Peer IP Address	Address of the neighbor protocol.
Serv/Peer	List of NTP peers and servers configured or dynamically learned.

show ntp statistics

Use this command to display NTP statistics.



Note: The commands "show ntp statistics" and "show ntp peer-status" do not produce output when both IPv6 and IPv4 ACL rules, configured with `deny udp any any eq ntp`, are applied to the **line vty**.

Command Syntax

```
show ntp statistics (io | local | memory | peer ( ipaddr (A.B.C.D | X:X::X:X ) | name (HOSTNAME)) )
```

Command Syntax

io

Counters maintained in the input-output module

local

Counters maintained in the local protocol module

memory

Counters related to memory allocation

peer

Counters associated with the specified peer

A.B.C.D

Peer IPv4 address

X:X::X:X

Peer IPv6 address

HOSTNAME

Peer host name

Command Mode

Execution mode and Privileged execution mode

Applicability

This command was introduced before OcNOS version 1.3.

Example

```
#show ntp statistics local
time since restart: 1685
time since reset: 1685
```

```

packets received: 4
packets processed: 0
current version: 0
previous version: 0
declined: 0
access denied: 0
bad length or format: 0
bad authentication: 0
rate exceeded: 0
#show ntp statistics memory
time since reset: 1698
total peer memory: 15
free peer memory: 15
calls to findpeer: 0
new peer allocations: 0
peer demobilizations: 0
hash table counts: 0 0 0 0 0 0 0 0
0 0 0 0 0 0 0 0
0 0 0 0 0 0 0 0
0 0 0 0 0 0 0 0
0 0 0 0 0 0 0 0
0 0 0 0 0 0 0 0

```

Table 25 explains the output fields.

Table 25. show ntp statisticsfields

Entry	Description
Time since restart	Time when the ntp protocols were last started and how long they have been running.
Time since reset	Time when the ntp protocols were last reset and how long they have been running.
Packets received	Number of packets received from the peers.
Packets processed	Number of packets processed to the peers.
Current version	Current version of the protocol that is being used.
Previous version	Previous version of the protocol that has been used.
Declined	Access to the protocol declined
Access denied	Number of attempts denied to access protocol
Bad length or format	Number of messages received with length or format errors so severe that further classification could not occur.
Bad authentication	Number of messages received with incorrect authentication.
Rate exceeded	Exceed the configured rate if additional bandwidth is available from other queues
Total peer memory	Actual memory available to the peer system.
Free peer memory	Free memory available to the peer system.
Calls to find peer	Number of calls to find peer.
New peer allocations	Number of allocations from the free peer list.
Peer demobilizations	Number of structures freed to free peer list.
Hash table counts	Peer hash table's each bucket count.

show ntp trusted-keys

Use this command to display keys that are valid for authentication.

Command Syntax

```
show ntp trusted-keys
```

Command Syntax

None

Command Mode

Execution mode and Privileged execution mode

Applicability

This command was introduced before OcNOS version 1.3.

Example

```
#show ntp trusted-keys
Trusted Keys:
333
#
```

[Table 26](#) explains the output fields.

Table 26. show ntp trusted-keys fields

Entry	Description
Trusted Keys	Keys that are valid for authentication.

show running-config ntp

Use this command to display the NTP running configuration.

Command Syntax

```
show running-config ntp ([all])
```

Command Syntax

all

Reserved for future use

Command Mode

Execution mode and Privileged execution mode

Applicability

This command was introduced before OcNOS version 1.3.

Example

```
#sh running-config ntp
feature ntp vrf management
ntp enable vrf management
ntp authenticate vrf management
ntp logging vrf management
ntp authentication-key 123 md5 0xa2cb891442844220 7 vrf management
ntp trusted-key 123 vrf management
ntp server 216.239.35.4 vrf management
```

| FAULT MANAGEMENT SYSTEM CONFIGURATION

Fault Management System Configuration	556
Implementation Example	557
Enabling and Disabling the Fault Management System	557
Alarm Configuration File	557
Alarm Descriptions	559
Event Manager	561
Overview	561
Configuration	563
Event Manager Commands	564
Glossary	575

Fault Management System Configuration

The Fault Management System (FMS) provides a framework for event detection, correlation, and alarm generation. Each event triggers an alarm based on correlation logic parameters specified by individual Protocol Modules. Events, as OPER_LOGs relayed from the VLOGd module, are processed according to the correlation rules in the configuration file `alarm_def_config.yaml`. The generated alarms persist to indicate faults and are maintained in a database accessible via `show` commands.



Notes:

- FMS is disabled by default. Once enabled, it triggers alarms for all valid OPER_LOG events received by the FMS `node.js` process.
- The FMS event-alarm correlation configuration is stored in a YAML file (`alarm_def_config.yaml`), which cannot be modified via CMLSH commands. If changes are required, an operator with the appropriate privileges can edit the file in YAML syntax, but only before starting FMS. Once FMS is active, editing this file is prohibited, as changes take effect only after FMS is disabled, updated, and then re-enabled.
- The device’s logging level must be set to at least 4 (NOTIFY) to ensure that FMS receives notification events and can take appropriate action. Setting a lower logging level may prevent FMS from receiving clear events, resulting in unresolved active alarms. FMS does not manage the system logging level.
- FMS relies on the loopback interface (`100`) for communication with VLOGd, so the operational status of `100` is essential for both FMS and VLOGd.
- If Localhost communication is blocked by the Access Control List (ACL), FMS must be disabled. Conversely, if FMS is enabled, the ACL must not block Localhost.
- If FMS reboots due to a device reboot, upgrade, downgrade, or manual restart, active alarms are closed. Use the `show alarm closed` CLI command to view closed active alarms.

FMS applies correlation procedures based on the configurations specified in the below table:

Table 27. FMS correlation procedures

Correlation type	Description
Generalization	<ul style="list-style-type: none"> • Groups two or more events into a single alarm. • A generalized alarm will further use one of the correlation types (none, time-bound, counting and compression) for applying correlation logic to the new alarm.
Time-bound	<ul style="list-style-type: none"> • Stipulates that when the event is received, a timer is started for that event. • While the timer is running, subsequent events of the same type are suppressed. • On the expiry of the timer, an alarm will be raised for that event stating the count for the number of times that event was received in this duration.
Counting	Considers a specified number of similar events as one. In this correlation type, the respective alarm will be raised after the event has occurred for count times.
Compression	Check multiple occurrences of the same event for duplicate/redundant event information,

Table 27. FMS correlation procedures (continued)

Correlation type	Description
	remove the redundancies, and report them as a single alarm.
Severity	Correlates events based on the severity of the events.

Implementation Example

FMS was developed with NodeJS with scripts written in JavaScript with a *.js extension and configuration files with a *.yaml extension. These files are in the below paths in OcNOS.

Table 28. FMS script and configuration files

/usr/local/bin/js	JavaScript files (*.js files)
/usr/local/etc	Configuration files (*.yaml files)

Enabling and Disabling the Fault Management System

Follow the below steps to enable or disable FMS:

Enabling FMS

```
OcNOS#configure terminal
Enter configuration commands, one per line. End with CNTL/Z.
(config)#
(config)#fault-management enable
(config)#
```

Disabling FMS

```
OcNOS#configure terminal
Enter configuration commands, one per line. End with CNTL/Z.
(config)#
(config)#fault-management disable
(config)#
```

Alarm Configuration File

The alarm configuration file contains the configurations or rules for the alarms that will be referred by FMS to generate alarms upon receiving events. This file is in *.yaml format (human readable) in /usr/local/etc.

This file can be edited before starting FMS to include correlation rules for specific events.

Alarm Configuration File Template

```
#-----Template-----
#- Event_Group:
# - ALARM_ID: # Integer number identifying alarm
# ALARM_TYPE_ID: # Alarm Type-id(AIS, EQPT, LOS, OTS, OPWR, UNKNOWN)
# EVENT: # Event name(oper_log)
# GENERALIZED_EVENT_NAME: # Event name for the Generalization Event Group
# ALARM_DESC: # Alarm string which will be generated
# CORRELATION_TYPE: # Correlation logic type(0:No-Correlation, 1:Generalization,
```

```

2:Timebound, 3:Counting, 4:Compression, 5:Drop-Event, 6:Severity)
#   GENERALIZED_CORRELATION_TYPE   # Correlation type, in which generalized event will be sent
#   CORRELATION_COUNTER:          # Counter value that will be considered during counting logic
to raise alarm
#   CORRELATION_TIMER_DURATION:    # Timer duration to be considered for time bound logic
#   CORRELATION_SEVERITY:         # Alarm Severity(0:Critical, 1:Major, 2:Warning, 3:Minor,
4:Unknown)
#   QUALIFIER_STRING_POSITION:    # List of positions where qualifier values present
#   QUALIFIER_POSITION_1_EVENT_1: # First position of the qualifier value in the first event
#   RESOURCE_STRING_POSITION:     # List of positions where resource values present
#   RESOURCE_POSITION_1_EVENT_1:  # First position of the resource value in the first event
#   SNMP_TRAP:                   # SNMP TRAP (true(1) or false(0))
#   SNMP_OID:                    # OID for SNMP TRAP
#   NETCONF_NOTIFICATION:        # Netconf Notification (true(1) or false(0))
#   CLEAR_ALARM:                 # Clear Alarm (oper_log enum, Status for Alarm will be made In-
active if this event is received)
#   CLEAR_EVENT_PATTERN_VALUES:   # Pattern values which will be searched in event's description
to identify clear event and to clear active alarm (required if both active and clear event types are
same)
#   SNMP_TRAP_CLEAR:             # true(1) or false(0, if CLEAR_ALARM is null then SNMP_TRAP_
CLEAR will be null)
#   SNMP_CLEAR_OID:              # OID for SNMP TRAP CLEAR
#   NETCONF_CLEAR_NOTIFICATION:  # Clear Netconf Notification information

```

Auto Generating the Alarm Configuration File

The `auto_yaml_generator.js` file is a NodeJS script that generates the alarm configuration file (`alarm_def_config.yaml`) for the oper logs which are listed in the `oper_logs_list.yaml` file with the default values as shown below.

```

# Integer number identifying alarm
ALARM_ID: 1000
# Event name (oper_log)
EVENT: oper_log string
# Event name for the Generalization Event Group
GENERALIZED_EVENT_NAME: null
# Alarm string which will be generated
ALARM_DESC: oper_log string
# Correlation logic type (0: No-Correlation, 1: Generalization, 2: Time Bound, 3: Counting, 4:
Compression, 5: Drop-Event)
CORRELATION_TYPE: 0
# Correlation type, in which generalized event will be sent
GENERALISED_CORRELATION_TYPE: null
# Counter value that will be considered during counting logic to raise alarm
CORRELATION_COUNTER: 3
# Timer duration to be considered for time bound logic
CORRELATION_TIMER_DURATION: 20000
# Alarm Severity(1:Emergency, 2:Alert, 3:Critical, 4:Error, 5:Warning, 6:Notification,
7:Informational, 8:Debugging, 9:Cli)
CORRELATION_SEVERITY: null
# QUALIFIER_STRING_POSITION
QUALIFIER_POSITION_1_EVENT_1: null
# RESOURCE_STRING_POSITION
RESOURCE_POSITION_1_EVENT_1: null
SNMP_TRAP: 0
# OID for SNMP TRAP
SNMP_OID: null
# Netconf Notification (true (1) or false (0))
NETCONF_NOTIFICATION: 1
# Clear Alarm (oper_log enum, Status for Alarm will be made In-active if this event is received)
CLEAR_ALARM: null
# Clear Event's pattern values which will be searched in event's description to identify clear event
CLEAR_EVENT_PATTERN_VALUES: null
# True (1) or False (0, if CLEAR_ALARM is null then SNMP_TRAP_CLEAR will be null)
SNMP_TRAP_CLEAR: 0
# OID for SNMP TRAP CLEAR

```

```
SNMP_CLEAR_OID: null
# Clear Netconf Notification information
NETCONF_CLEAR_NOTIFICATION: 0
```

Alarm Configuration File Generation Steps

1. List all the `oper_log` enums in the `oper_logs_list.yaml` file and keep the file in the same path with `auto_yaml_generator.js`.
2. Copy `auto_yaml_generator.js` and `oper_logs_list.yaml` files into `/usr/local/bin/js`.
3. Run the `auto_yaml_generator.js` script with the following command.

```
#node auto_yaml_generator.js
```
4. After executing the above commands, you will see the `alarm-def-config.yaml` file in the same directory.

Sample `oper_logs_list.yaml` File

```
EVENT_GROUP:
  IFMGR_IF_DOWN,
  IFMGR_IF_UP,
  STP_SET_PORT_STATE,
  STP_IPC_COMMUNICATION_FAIL,
  STP_ROOTGUARD_PORT_BLOCK,
  :
  :
```

Alarm Descriptions

The table below describes the supported alarms.

Table 29. FMS alarms

Alarm	Description
<code>CMM_DDM_MONITOR_CURRENT</code>	Transceiver Bias Current crossed the threshold limit
<code>CMM_DDM_MONITOR_FREQ</code>	Transceiver Frequency crossed the threshold limit
<code>CMM_DDM_MONITOR_RXPOWER</code>	Transceiver Rx Power crossed the threshold limit
<code>CMM_DDM_MONITOR_TEC</code>	Transceiver Thermoelectric Cooler fault
<code>CMM_DDM_MONITOR_TEMP</code>	Transceiver Temperature crossed the threshold limit
<code>CMM_DDM_MONITOR_TXPPOWER</code>	Transceiver Tx Power crossed the threshold limit
<code>CMM_DDM_MONITOR_VOLT</code>	Transceiver Voltage crossed the threshold limit
<code>CMM_DDM_MONITOR_WAVE</code>	Transceiver Wavelength crossed the threshold limit
<code>CMM_FAN_CTRL</code>	Fan insertion, removal, speed, or fault condition alarm
<code>CMM_MONITOR_CPU</code>	CPU load average crossed the threshold limit
<code>CMM_MONITOR_CPU_CORE</code>	CPU core usage crossed the threshold limit
<code>CMM_MONITOR_CURRENT</code>	Current crossed the threshold limit
<code>CMM_MONITOR_DISK_READ_ACTIVITY</code>	Disk read activity crossed the threshold limit
<code>CMM_MONITOR_DISK_REMAIN_LIFE</code>	Disk remaining life crossed the threshold limit

Table 29. FMS alarms (continued)

Alarm	Description
CMM_MONITOR_DISK_WRITE_ACTIVITY	Disk write activity crossed the threshold limit
CMM_MONITOR_FAN	FAN RPM crossed the threshold limit
CMM_MONITOR_PSU_IIN	Power supply unit input current crossed the threshold limit
CMM_MONITOR_PSU_IOUT	Power supply unit output current crossed the threshold limit
CMM_MONITOR_PSU_PIN	Power supply unit input power crossed the threshold limit
CMM_MONITOR_PSU_POUT	Power supply unit output power crossed the threshold limit
CMM_MONITOR_PSU_POWER	Power supply unit insertion, removal, or fault condition
CMM_MONITOR_PSU_PRESENCE	Power supply unit is present
CMM_MONITOR_PSU_TEMP1	Power supply unit temperature 1 crossed the threshold limit
CMM_MONITOR_PSU_TEMP2	Power supply unit temperature 2 crossed the threshold limit
CMM_MONITOR_PSU_VIN	Power supply unit input voltage crossed the threshold limit
CMM_MONITOR_PSU_VOUT	Power supply unit output voltage crossed the threshold limit
CMM_MONITOR_RAM	RAM memory usage crossed the threshold limit
CMM_MONITOR_SDCARD	Hard-disk usage crossed the threshold limit or fault condition
CMM_MONITOR_TEMP	Temperature sensor crossed the threshold limit
CMM_MONITOR_VOLTAGE	Voltage crossed the threshold limit
CMM_TRANSCEIVER	Transceiver on fault condition
IFMGR_IF_DOWN	Interface state down
IFMGR_IF_UP	Interface state up
HW_PROFILE_MONITOR	TCAM group utilization

Event Manager

Overview

The event manager feature facilitates the automatic execution of a particular action item based on the event (operator log messages) that occurred in a device. This feature is configured by command line interface (CLI) and NetConf.

The following are the three parameters in the event manager feature:

- **Event:** It is a trigger where event manager functionality starts. Once the syslog message with the details mentioned in the event occurs, an action is triggered. Some sample events are as follows:
 - **IFMGR_IF_DOWN**
 - **IFMGR_IF_UP**
 - **STP_SET_PORT_STATE**
 - **STP_IPC_COMMUNICATION_FAIL**
- **Action:** Once an event has occurred, an action is triggered if there is a match of the event ID in the database. An action is executed by the execution of a Python script consisting of executable OcNOS commands and configurations.

The sample action script is as follows:

```
import sys,os,time
import subprocess

#MACROS#
#####
TIME = 1

#VARIABLES#
#####
cmd_db_lock = "cmlsh -e 'configure terminal force "+str(TIME)+"'"
cli_commands = "cmlsh -e 'configure terminal' -e 'interface xell' -e 'shutdown' -e 'commit' -e 'end'"

if __name__ == '__main__':
    #if name == 'main':
        #Force user out of config mode after X seconds
        os.system (cmd_db_lock)
        #Wait X seconds before running clis
        time.sleep(TIME)

        os.system(cli_commands)
```

- **Policy¹:** It maps the action with an event.

Feature Characteristics

- The feature creates a database of event IDs and the corresponding actions as configured through CLI. When an event occurs, the event is matched in the database with the existing event ID, severity, and log pattern. If the event matches with the existing event in the database, it triggers a corresponding action automatically. If

¹A set of rules determining which actions are permitted or denied for a specific user role.

there is no match with the database, then no action is taken.

- Configurable parameters for an event are event ID, severity, and log pattern, which are matched with the incoming log. In order to be unique, the recommendation is to have all these parameters configured for an event. Configuring the event ID is mandatory, while severity and pattern are optional. No manual configuration of severity applies the default severity of **a11 (0-6)**.
- Duplicate event configuration with the same value for event ID, severity, and log pattern as an existing event with a new event name is not allowed and displays an error.
- The feature facilitates the configuration of one action for multiple events.
- Place the action script file in the path `/usr/local/etc`. A warning message is displayed if the script file is not in the path, but the configuration is accepted.
- The execution count or the trigger count per policy is stored and maintained. When a policy is cleared, the event and the action associated with the policy get cleared. When an action is associated with multiple policies, the action associated with the cleared policy is removed, and the same action associated with other policies remains.
- This feature consumes a certain amount of CPU performance because it matches the logs recorded by the system with every configured event. Hence, a maximum number of 50 events, actions, and policies is configurable.
- The command line shell (cmlsh) uses a locking mechanism. Follow the recommendation when a user or script file gets into the configure mode:
 - Disable the event manager feature while executing manual configuration in the system. This prevents the Python script from interfering with the manual configuration. After executing the manual configuration, enable the event manager feature.
 - There is a possibility of multiple Python scripts executing simultaneously. In order to sequence the configure mode execution, the Python script has the logic to wait for 45 seconds in the configure mode. This prevents the Python script from exiting without executing the commands if another script is still in configure mode.
 - If the script fails to execute, the event manager does not record such failures.

Validation checks

- When the feature is neither enabled nor disabled, the event, action, or policy configuration displays an error.
- The event manager displays an error if an event is edited when associated with a policy.
- The event manager exercises priority-based selection of policies for any incoming logs. When there are more actions associated with the same event with different event IDs, severity levels, and pattern, the priority sequence is as follows:
 1. Matches the incoming log against a policy that has an event configured with all the parameters, which are event ID, severity, and pattern string.
 2. Matches the incoming log against a policy that has an event configured with only event ID and severity.
 3. Matches the incoming log against a policy that has an event configured only with the event ID.

Example 1

For the following configuration, when actual log `"2020 Jan 03 08:46:56.455 : MH2 : NSM : CRITI : [IFMGR_IF_UP_2]: Interface xe3 changed state to up"` is received, event-manager execute **action a2** (file2) than **action a1** as this configuration matches the best.

```
#event-manager event e1 IFMGR_IF_UP severity 2
#event-manager event e2 IFMGR_IF_UP severity 2 pattern "Interface xe3"
#event-manager action a1 script file1
#event-manager action a2 script file2
#event-manager policy p1 event e1 action a1
#event-manager policy p2 event e2 action a2
```

Example 2

For the following configuration, when actual log "2020 Jan 03 08:46:56.455 : MH2 : NSM : CRITI : [IFMGR_IF_UP_2]: Interface xe3 changed state to up" is received, event-manager executes either **action a1** (file1) or **action a2** based on whichever gets hit first during database search. The recommendation is not to mix the same event configuration with a pattern and without a pattern for the same event ID.

```
#event-manager event e1 IFMGR_IF_UP severity 2 pattern "Interface "
#event-manager event e2 IFMGR_IF_UP severity 2 pattern "Interface xe3"
#event-manager action a1 script file1
#event-manager action a2 script file2
#event-manager policy p1 event e1 action a1
#event-manager policy p2 event e2 action a2
```

- The solution supports the validation of event-id against configurable event-ids. It displays an error if the entered event-id is not supported.

Benefits

The event manager feature allows the execution of an automatic action when a failure or any other priority error occurs.

Configuration

This section shows the configuration of the Event Manager feature.

Configuring Event Manager

Follow the steps to configure the Event Manager feature.

1. Configure the command **event-manager enable** to enable event-manager functionality in the device.

```
(config)#event-manager enable
```

2. Follow the steps to configure an event or an action.:
 - To create an event, define the **event** name (**E1**), **type** (**syslog**), event ID (**IFMGR_IF_UP**), and optional parameters of **severity** (**0**) and **pattern** ("**xe5**").

```
(config)#event-manager event E1 type syslog IFMGR_IF_UP severity 0 pattern "xe5"
```

- To create an action, save the python script in the **/usr/local/etc** path and define the action name (**A1**), the type (**script**) and the type value (**ifup.py**).

```
(config)#event-manager action A1 type script ifup.py
```

3. To map an event to an action, create a policy, specify the policy name (**P1**), and map the event name (**E1**) with the action name (**A1**).

```
(config)#event-manager policy P1 event E1 action A1
```

Running configurations

The running configuration is as follows:

```
!
event-manager enable
event-manager action A1 type script ifdown.py
event-manager event E1 type syslog IFMGR_IF_DOWN pattern "xe5"
event-manager policy P1 event E1 action A1
!
```

Validation

Validate the show output after configuration as shown below.

```
#show event-manager event all

Events configured : 1

Event Name                Type      Type Value  Trigger Cnt  Status  Policy-Mapped
=====
E1                        syslog    IFMGR_IF_U  0            Active  P1

#show event-manager action all

Actions configured : 1

Action Name                Type      Type Value  Trigger Cnt  Policy-Count  Status
=====
A1                          script    ifup.py     0            1            Active

#show event-manager policy all

Policies configured : 1

Policy Name                Trigger Cnt  Event      Action      Last Exec Status  Last Exec
=====
P1                          0           E1         A1          Not-Run         -

*****
*****
```

Event Manager Commands

The Event Manager feature introduces the following configuration and show commands.

clear event-manager statistics	565
event-manager	566
event-manager action	567
event-manager event	568
show event-manager action	570
show event-manager event	572
show event-manager policy	574
show event-manager system-event-ids	575

clear event-manager statistics

Use this command to clear all the policies or a specific policy.



Note: The clear policy removes the action associated with this policy, but the same action associated with other policies remain.

Command Syntax

```
clear event-manager statistics (policy NAME|all|)
```

Parameters

policy NAME

Removes the specific policy.

statistics all

Removes all the configured policies.

Default

None

Command Mode

Configure mode

Applicability

Introduced in OcNOS version 6.5.1.

Examples

The below configuration shows how to clear all the policies:

```
OcNOS#configure terminal
OcNOS(config)#clear event-manager statistics all
OcNOS(config)#commit
OcNOS(config)#exit
```

event-manager

Use this command to enable or disable the event manager feature. The event manager intercepts the incoming logs for the configured event when the event and action are mapped to a policy.

Use the `no` command to remove all the event manager configurations.

Command Syntax

```
event-manager (enable|disable)
no event-manager
```

Parameters

enable

Enables the event manager feature to configure events, actions, and policies.

disable

Disables the event manager feature, but the configuration of new events, actions, and policies is allowed, and the existing configuration remains the same.

Default

None

Command Mode

Configure mode

Applicability

Introduced in OcNOS version 6.5.1.

Examples

The below configuration shows how to enable the event manager:

```
OcNOS#configure terminal
OcNOS(config)#event-manager enable
OcNOS(config)#commit
OcNOS(config)#exit
```

The below configuration shows how to disable the event manager:

```
OcNOS#configure terminal
OcNOS(config)#event-manager disable
OcNOS(config)#commit
OcNOS(config)#exit
```

event-manager action

Use this command to create an action, configure an action name, and associate a Python script.

Use `no` command to remove an action.



Note: Configuration of an existing action with new parameters overwrites the old configured parameters.

Command Syntax

```
event-manager action NAME type script SCRIPT
no event-manager action NAME
```

Parameters

action NAME

Name of the action that is configured.

script SCRIPT

Name of the Python script associated with the action.

Default

None

Command Mode

Configure mode

Applicability

Introduced in OcNOS version 6.5.1.

Examples

The below configuration shows how to configure an action:

```
OcNOS#configure terminal
OcNOS(config)#event-manager action A1 type script ifup.py
OcNOS(config)#commit
OcNOS(config)#exit
```

event-manager event

Use this command to configure an event with the event name and event ID, along with the options to configure the severity and the pattern.

Use no form of the command to remove an event or remove the parameters from an event.



Notes:

- Configuration of an event with a different event name but the same event ID, severity, and pattern is not supported, and an error is displayed.
- Configuration of an existing event with new parameters overwrites the old configured parameters.

Command Syntax

```
event-manager event NAME type syslog EVENT-ID (severity <0-5>|all|) (pattern "PATTERN"|)
no event-manager event NAME (severity|pattern|)
```

Parameters

event NAME

Name of the event that is configured.

syslog EVENT-ID

A problem keyword that gets matched with the incoming logs to trigger the configured action.

severity <0-5>

(Optional) If configured with a severity level, this parameter is matched with the incoming logs to trigger an event with the configured severity level only. The range is from 0 to 5.

severity all

(Optional) If not configured, this parameter is matched with the incoming logs to trigger an event with all the severity levels (from 0 to 5).

pattern "PATTERN"

(Optional) If configured with a sub-string, this parameter matches the sub-string with the incoming log to trigger an event.

Default

None

Command Mode

Configure mode

Applicability

Introduced in OcNOS version 6.5.1.

Examples

The below configuration shows how to configure an event:

```
OcNOS#configure terminal
OcNOS(config)#event-manager event E1 type syslog IFMGR_IF_UP severity 0 pattern "xe5"
```

```
OcNOS (config) #commit  
OcNOS (config) #exit
```

show event-manager action

Use this command to display the action name, the action type, the Python script name, the number of times the script runs, the number of associated policies, and the status.

Command Syntax

```
show event-manager action (NAME|all|)
```

Parameters

action NAME

Displays the configuration details of a specific action.

action all

Displays the configuration details of all the configured actions.

Default

None

Command Mode

Execution mode

Applicability

Introduced in OcNOS version 6.5.1.

Examples

The below configuration displays all the actions configured:

```
#show event-manager action all

Actions configured : 1

Action Name                Type      Type Value  Trigger Cnt  Policy-Count  Status
=====
A1                          script    ifup.py     0            1             Active
```

[Table 30](#) explains the show command output fields.

Table 30. show event-manager action

Field	Description
Action Name	Displays the name of the configured action or actions.
Type	Displays the type of the action or actions.
Type Value	Displays the name of the Python script.
Trigger Cnt	Displays the number of time the action runs the script.
Policy ¹ -Count	Displays the number of policies associated with the action.

¹A set of rules determining which actions are permitted or denied for a specific user role.

Field	Description
Status	Displays if the action is active or not. The action remains inactive if not mapped with a policy.

show event-manager event

Use this command to display the event name, the event type, the event ID, the number of times the event was triggered, the event status, and the associated policy.

Command Syntax

```
show event-manager event (NAME|all|)
```

Parameters

event NAME

Displays the configuration details of a specific event.

event all

Displays the configuration details of all the configured events.

Default

None

Command Mode

Execution mode

Applicability

Introduced in OcNOS version 6.5.1.

Examples

The below configuration displays all the event configured:

```
OcNOS#show event-manager event all

Events configured : 1

Event Name                Type      Type Value  Trigger Cnt  Status  Policy-Mapped
-----
E1                        syslog    IFMGR_IF_U    0            Active  P1
```

[Table 31](#) explains the show command output fields.

Table 31. show event-manager event output fields

Field	Description
Event Name	Displays the name of the configure event or events.
Type	Displays the type of the event or events.
Type Value	Displays the event IDs.
Trigger Cnt	Displays the number of time the event is matched with the incoming log and triggered an action.
Status	Displays if the event is active or not. The event remains inactive if not mapped with a policy.

Field	Description
Policy ¹ -Mapped	Displays the policy name associated with the event.

¹A set of rules determining which actions are permitted or denied for a specific user role.

show event-manager policy

Use this command to display the policy name, number of times the event triggers the action, the event name, the action name, the status of the last action triggered, and the time of last action triggered.

Command Syntax

```
show event-manager policy (NAME|all|)
```

Parameters

policy NAME

Displays the configuration details of a specific policy.

policy all

Displays the configuration details of all the configured policies.

Default

None

Command Mode

Execution mode

Applicability

Introduced in OcNOS version 6.5.1.

Examples

The below configuration displays all the event configured:

```
#show event-manager policy all

Policies configured : 1

Policy Name           Trigger Cnt   Event   Action   Last Exec Status   Last Exec
Time
=====
P1                    0            E1      A1       Not-Run            -
```

Table 32. show event-manager policy

Field	Description
Policy ¹ Name	Displays the name of the configured policy or policies.
Trigger Cnt	Displays the number of time the action runs the script.
Event	Displays the name of the associated event.
Action	Displays the name of the associated action.
Last Exec Status	Status of the last action triggered.
Last Exec Time	Time of the last action triggered.

¹A set of rules determining which actions are permitted or denied for a specific user role.

show event-manager system-event-ids

Use this command to display all the event IDs.

Command Syntax

```
show event-manager system-event-ids (all| SUBSTRING)
```

Parameters

system-event-ids all

Displays all the event IDs.

system-event-ids SUBSTRING

Displays the event IDs with this substring.

Default

None

Command Mode

Execution mode

Applicability

Introduced in OcNOS version 6.5.1.

Examples

The command below displays all the event IDs supported in OcNOS.

```
OcNOS#show event-manager system-event-ids all

IFMGR_IF_DOWN                IFMGR_IF_UP
STP_SET_PORT_STATE           STP_IPC_COMMUNICATION_FAIL
STP_ROOTGUARD_PORT_BLOCK    STP_BPDUGUARD_PORT_BLOCK
MCEC_CONF_MISMATCH          BGP_VPLS_CREATE_ERR
BGP_VPLS_SAME_VE_ID_ERR     BGP_VPLS_MTU_MISMATCH_ERR
LDP_INTERNAL_ERR            LDP_MSG_DECODE_ERR
:::
:::
```

The command below displays all the event IDs configured with substring "OSPF" supported in OcNOS.

```
OcNOS#show event-manager system-event-ids ospf

OSPF_OPR_INIT_FAILED        OSPF_OPR_GRACEFUL_RESTART_FAILED
OSPF_OPR_MEM_EXHAUST        OSPF_OPR_DUPLICATE_ROUTER_ID
OSPF_OPR_SELF_ORIGINATED_LSA_RECVD  OSPF_OPR_IFMGR_FAIL
OSPF_OPR_SESSION_DOWN      OSPF_OPR_TERMINATE
OSPF_OPR SOCK_FAIL          OSPF_OPR_SPF_EMPTY_RLSA
OSPF_OPR_INACTIVITY_TIMER_EXPIRED  OSPF_OPR_LOWER_LEVEL_DOWN
OSPF_OPR_BFD_SESSION_DOWN    OSPF_OPR_LSDB_OVERFLOW
:::
:::
```

Glossary

The following provides definitions for key terms or abbreviations and their meanings used throughout this document:

Key Terms/Acronym	Description
Python script	This is a script file containing a sequence of code that executes an action when an event is triggered. This is a text file with “.py” extension.

FAULT MANAGEMENT SYSTEM COMMAND REFERENCE

FMS Command Reference	578
fault-management (enable disable)	579
fault-management close	580
fault-management flush-db	582
fault-management shelve	583
show alarm active	585
show alarm closed	586
show alarm history	587
show alarm shelved	588
show alarm statistics	589
show alarm transitions	590
show fms status	591
show fms supported-alarm-types	592
show running-config fault-management	593

FMS Command Reference

This chapter describes the fault management system (FMS) commands:

fault-management (enable disable)	579
fault-management close	580
fault-management flush-db	582
fault-management shelve	583
show alarm active	585
show alarm closed	586
show alarm history	587
show alarm shelved	588
show alarm statistics	589
show alarm transitions	590
show fms status	591
show fms supported-alarm-types	592
show running-config fault-management	593

fault-management (enable | disable)

Use this command to enable or disable the fault management system (FMS).



Note: If the loopback interface is down, FMS will not receive logs, preventing it from generating and clearing alarms, resulting in the loss of these logs.

Command Syntax

```
fault-management (enable | disable)
```

Parameters

enable

Enable FMS

disable

Disable FMS

Default

None

Command Mode

Configure mode

Applicability

This command was introduced in OcNOS version 3.0.

Example

1. Enable FMS

```
(config)# fault-management enable
(config)#commit
%% Warning : FMS requires logging level all to be configured to minimum 4, please configure accordingly
(config)#
```

2. Validation after enabling

```
#show fms status
% FMS Status: Enabled
% FMS Node Application Status: Up
```

3. Disable FMS

```
(config)# fault-management disable
(config)#commit
```

4. Validation after disabling

```
#show fms status
% FMS Status: Disabled
```

fault-management close

Use this command to close an active alarm.

Command Syntax

```
fault-management close ACTIVE-ALARM-ID
```

Parameters

ACTIVE-ALARM-ID

Identifier of an active alarm

Default

None

Command Mode

Execution mode and Privileged execution mode

Applicability

This command was introduced in OcNOS version 6.0.0.

Example

Ensure that closed alarms do not remain in the active alarm list.

The alarm ID can be found with [show alarm history \(page 587\)](#), specifying the `all` parameter.

1. View Alarm History

```
#show alarm history all
Alarm Count: 1
Severity   Alarm_Type_ID  Alarm_ID           Description
-----
MAJOR     EQPT            IFMGR_IF_DOWN::ce3/1  2019-02-18T15:07:57.755Z : OcNOS [IFMGR_IF_DOWN]
Interface ce3/1 changed state to down
```

2. View Active Alarms

```
#show alarm active
Active Alarms received:-
Active Alarm Count: 1
Severity   Status   Alarm Description
-----
MAJOR     Active   OcNOS [IFMGR_IF_DOWN] Interface ce3/1 changed state to down
```

3. Close the Alarm

```
#fault-management close IFMGR_IF_DOWN::ce3/1
% FMS Response: IFMGR_IF_DOWN::ce3/1 closed
```

4. Verify Closure

```
#show alarm active
Active Alarms received:-
There are no active alarms present in the Database
```

fault-management flush-db

Use this command to flush the alarms from the database.

Command Syntax

```
fault-management flush-db
```

Parameters

None

Default

None

Command Mode

Execution mode and Privileged execution mode

Applicability

This command was introduced in OcNOS version 3.0.

Example

```
OcNOS#fault-management flush-db
% FMS Response: Database flush completed
```

Check that after fault-management flush-db, all alarms in the database are flushed:

```
OcNOS#show alarm active
Active Alarms received:-
There are no active alarms present in the Database

OcNOS#show alarm history all
There are no alarms present in the Database

OcNOS#show alarm closed
No alarms are manually closed

OcNOS#show alarm shelved
No alarm-types are shelved

OcNOS#show alarm statistics
There are no alarms present in the Database

OcNOS#show alarm transitions
There are no transition alarms present in the Database
```

fault-management shelve

Use this command to shelve (disable) an alarm type.

Command Syntax

```
fault-management shelve ALARM-TYPE
```

Parameter

ALARM-TYPE

Type of alarm as displayed by [show fms supported-alarm-types \(page 592\)](#)

Default

None

Command Mode

Execution mode and Privileged execution mode

Applicability

This command was introduced in OcNOS version 6.0.0.

Examples

1. Shelve an Alarm Type

```
#fault-management shelve CMM_MONITOR_CPU
% FMS Response: Alarm-type CMM_MONTOR_CPU shelved.
```

```
#fault-management shelve IFMGR_IF_DOWN
% FMS Response: Alarm-type IFMGR_IF_DOWN shelved.
```

2. Validate Shelving: Check that after shelving an alarm type, active alarms of that type are not being raised.

```
#show alarm shelved
Alarm-type Count: 1
Alarm Type
-----
IFMGR_IF_DOWN
```

3. Simulate Alarm Condition: Make configuration changes, such as shutting down an interface, to trigger the specified alarm type.

```
(config)#interface cel/1
(config-if)#shutdown
(config-if)#commit
2019 Feb 18 15:21:31.229 : OcNOS : NSM : CRITI : [IFMGR_IF_DOWN_2]: Interface cel/1 changed state
to down
(config-if)#end
```

4. Verify No New Active Alarms: Run `show alarm history all` and `show alarm active` to confirm no alarms of the shelved type appear in the history or active alarms list, verifying that shelving is effective.

```
#show alarm history all  
There are no alarms present in the Database
```

```
#show alarm active  
Active Alarms received:-  
There are no active alarms present in the Database
```

show alarm active

Use this command to display the current active alarms in the database.

Command Syntax

```
show alarm active
```

Parameters

None

Default

None

Command Mode

Execution mode and Privileged execution mode

Applicability

This command was introduced in OcNOS version 3.0 and the output changed in OcNOS version 6.1.0.

Example

```
#show alarm active
Active Alarms received:-
Active-Alarms-Count: 1
Alarm-Date-Time          Severity    Alarm-ID          Alarm-Description
-----
2019-02-15T19:57:14.525Z MAJOR      IFMGR_IF_DOWN::xe8  OcNOS [IFMGR_IF_DOWN] Interface xe8
changed state to down
```

show alarm closed

Use this command to display alarms that are manually closed.

Command Syntax

```
show alarm closed
```

Parameters

None

Default

None

Command Mode

Execution mode and Privileged execution mode

Applicability

This command was introduced in OcNOS version 6.0.0.

Example

```
#show alarm closed
Alarm Count: 1
Severity   Alarm_Type_ID  Alarm_ID           Description
-----
MAJOR     EQPT           IFMGR_IF_DOWN::xe7  FMS [IFMGR_IF_DOWN] Interface xe7 changed state to
down
```

show alarm history

Use this command to show the alarm history.

Command Syntax

```
show alarm history (1-day | 1-hr | 1-week | all)
```

Parameters

1-day

Display alarms in the last 1 day

1-hr

Display alarms in the last 1 hour

1-week

Display alarms in the last 1 week

all

Display all the alarms

Default

None

Command Mode

Execution mode and Privileged execution mode

Applicability

This command was introduced in OcNOS version 3.0.

Example

```
#show alarm history ?  
1-day  Display alarms in the last 1 day  
1-hr   Display alarms in the last 1 hour  
1-week Display alarms in the last 1 week  
all    Display all the alarms
```

show alarm shelved

Use this command to display shelved (disabled) alarm types.

Command Syntax

```
show alarm shelved
```

Parameters

None

Default

None

Command Mode

Execution mode and Privileged execution mode

Applicability

This command was introduced in OcNOS version 6.0.0.

Example

```
#show alarm shelved
Alarm-type Count: 1
Alarm Type
-----
IFMGR_IF_DOWN
```

show alarm statistics

Use this command to display the alarm statistics.

Command Syntax

```
show alarm statistics
```

Parameters

None

Default

None

Command Mode

Execution mode and Privileged execution mode

Applicability

This command was introduced in OcNOS version 3.0.

Example

```
#show alarm statistics
Alarm Statistics :-
Alarm Count: 1
Current Severity      Count      Alarm ID
-----
MAJOR                  1          IFMGR_IF_UP::ce3/1
```

show alarm transitions

Use this command to display severity transitions for every alarm in the device.

Command Syntax

```
show alarm transitions
```

Parameters

None

Default

None

Command Mode

Execution mode and Privileged execution mode

Applicability

This command was introduced in OcNOS version 6.0.0.

Example

```
#show alarm transitions
Alarms received:-
Alarm Count: 3
Transition      From      To        Alarm ID
Downgraded      CRITI     MAJOR     CMM_MONITOR_CPU:1min_load:CPU
Upgraded        MAJOR     CRITI     CMM_MONITOR_CPU:1min_load:CPU
Downgraded      CRITI     MAJOR     CMM_MONITOR_CPU:1min_load:CPU
```

show fms status

Use this command to display the FMS status.

Command Syntax

```
show fms status
```

Parameters

None

Default

None

Command Mode

Execution mode and Privileged execution mode

Applicability

This command was introduced in OcNOS version 3.0.

Example

```
#show fms status
% FMS Status: Enabled
% FMS Node Application Status: Up
```

show fms supported-alarm-types

Use this command to display the supported alarm types.

Command Syntax

```
show fms supported-alarm-types
```

Parameters

None

Default

None

Command Mode

Execution mode and Privileged execution mode

Applicability

This command was introduced in OcNOS version 6.0.0.

Example

```
#show fms supported-alarm-types
Alarm-types Count: 38

IFMGR_IF_DOWN
IFMGR_IF_UP
CMM_MONITOR_RAM
CMM_MONITOR_CPU
...
```

show running-config fault-management

Use this command to display FMS status in the running configuration.

Command Syntax

```
show running-config fault-management
```

Parameters

None

Default

None

Command Mode

Execution mode and Privileged execution mode

Applicability

This command was introduced in OcNOS version 3.0.

Example

```
#show running-config fault-management
!  
fault-management enable  
!
```

| SNMP CONFIGURATION

Simple Network Management Protocol	595
Overview	595
VRP Management Standard Configuration	596
User Defined VRF Standard Configuration	596
SNMP GET Command	597
SNMP WALK Command	597
SNMP Trap Server Configuration with IPv6 Address	598
SNMP Informs with IPv6 Address over User Defined VRF	600

Simple Network Management Protocol

Overview

SNMP provides a standardized framework and a common language for monitoring and managing devices in a network. The SNMP framework consists of three parts:

- An SNMP manager: The system used to control and monitor the activities of network devices. This is sometimes called a Network Management System (NMS).
- An SNMP agent: The component within a managed device that maintains the data for the device and reports these data SNMP managers.
- Management Information Base (MIB): SNMP exposes management data in the form of variables which describe the system configuration. These variables can be queried by SNMP managers.

In SNMP, administration groups are known as communities. SNMP communities consist of one agent and one or more SNMP managers. You can assign groups of hosts to SNMP communities for limited security checking of agents and management systems or for administrative purposes. Defining communities provides security by allowing only management systems and agents within the same community to communicate.

A host can belong to multiple communities at the same time, but an agent does not accept a request from a management system outside its list of acceptable community names.

SNMP access rights are organized by groups. Each group is defined with three accesses: read access, write access, and notification access. Each access can be enabled or disabled within each group.

The SNMP v3 security level determines if an SNMP message needs to be protected from disclosure and if the message needs to be authenticated. The security levels are:

- noAuthNoPriv: No authentication or encryption
- authNoPriv: Authentication but no encryption
- authPriv: Both authentication and encryption

SNMP is defined in RFCs 3411-3418.

Topology

Figure 39. SNMP sample topology

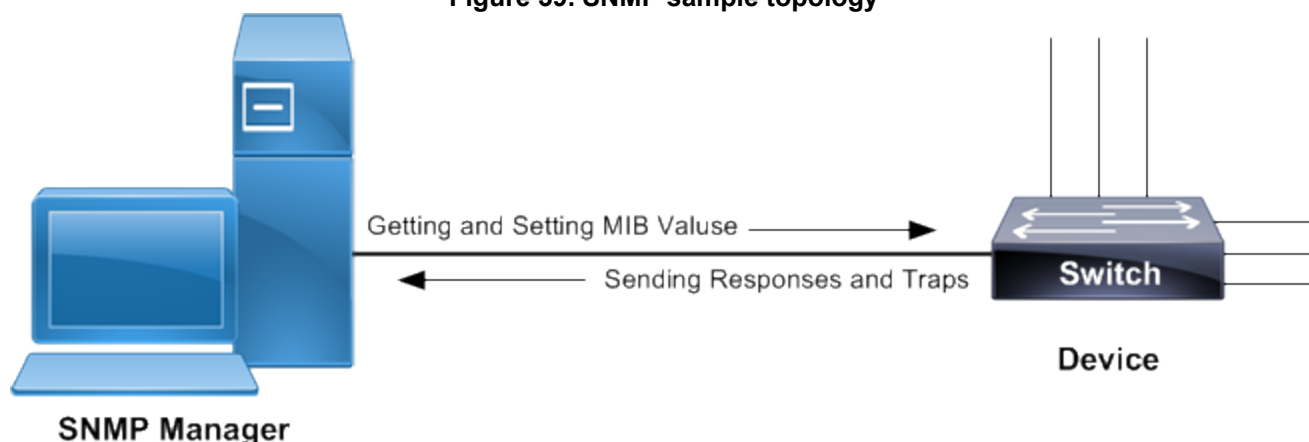

VRP Management Standard Configuration

#configure terminal	Enter configure mode.
(config)#snmp-server view all .1 included vrf management	Creates SNMP view labeled as “all” for OID-Tree as “.1” for vrf management.
(config)#snmp-server community test group network-operator vrf management	Set community string as “test” for group of users having “network-operator” privilege.
(config)#snmp-server host 10.12.6.63 traps version 2c test udp-port 162 vrf management host-vrf management	Specify host “10.12.6.63” of management vrf to receive SNMP version 2 notifications at udp port number 162 with community string as “test”.
(config)#snmp-server enable snmp vrf management	Use this command to start the SNMP agent.
(config-if)#exit	Exit interface configure mode
(config)#commit	Commit the candidate configuration to the running configuration

User Defined VRF Standard Configuration

OcNOS supports SNMP over the user defined VRFs as well apart from default and management VRFs via in-band interface. Users must be able to enable SNMP service over any user defined vrf however it only runs on one **VRF**¹ at once.

#configure terminal	Enter configure mode.
(config)#ip vrf snmp-vrf	Creates a user-defined vrf called snmp-vrf
(config)#commit	Commit the candidate configuration to the running configuration

¹Virtual Routing and Forwarding

<pre>(config)# snmp-server view newview 1.3.6.1.2.1.6.13.1.1.127.0.0.1 excluded vrf snmp- vrf</pre>	Creates SNMP view labeled as “newview” for OID-Tree “1.3.6.1.2.1.6.13.1.1.127.0.0.1” excluded for vrf snmp-vrf.
<pre>(config)# snmp-server community newcom group network-operator vrf snmp-vrf</pre>	Set community string as “newcom” for group of users having “network-operator” privilege.
<pre>(config)# snmp-server user newv3user auth sha AuthNewPass@123 priv aes PrivNewPass@123 vrf snmp- vrf</pre>	Creates SNMP V3 user “newv3user” with authentication encryption “sha” and privacy encryption “aes” passwords for added security on the snmp-vrf
<pre>(config)# snmp-server host 172.18.19.22 traps version 2c newcom udp-port 162 vrf snmp-vrf</pre>	Specify host “172.18.19.22” to receive SNMP version 2 notifications at udp port number 162 with community string as “newcom”.
<pre>(config)#snmp-server host 172.18.19.20 informs version 3 auth newv3user udp-port 65535 vrf snmp- vrf</pre>	Specify host “172.18.19.20” to receive SNMP v3 informs at udp-port number 65535 for user “newv3user” if correct authpriv passwords are used
<pre>(config)#snmp-server enable snmp vrf snmp-vrf</pre>	Use this command to start the SNMP agent on the user defined vrf (snmp-vrf)
<pre>(config)#commit</pre>	Commit the candidate configuration to the running configuration
<pre>(config)#exit</pre>	Exit configure mode.

Validation

Use the below commands to verify the SNMP configuration:

```
#show running-config snmp
snmp-server view all .1 included vrf management
snmp-server community test group network-operator vrf management
snmp-server host 10.12.6.63 traps version 2c test udp-port 162 vrf management

#show snmp group
-----
community/user   group           version  Read-View  Write-view  Notify-view
-----
test             network-operator  2c/1    all        none        all

#show snmp host
-----
Host             Port  Version  Level      Type        SecName  VRF
-----
10.12.6.63      162   2c       noauth    trap        test     management
```

SNMP GET Command

```
# snmpget -v2c -c test 10.12.45.238 .1.3.6.1.2.1.6.13.1.2.10.12.45.238.22.10.12.6.63.52214
TCP-MIB::tcpConnLocalAddress.10.12.45.238.22.10.12.6.63.52214 = IPAddress: 10.12.45.238
```

SNMP WALK Command

SNMP WALK for particular OID

```
#snmpwalk -v2c -c test 10.12.45.238 .1.3.6.1.2.1.25.3.8.1.8
HOST-RESOURCES-MIB::hrFSLastFullBackupDate.1 = STRING: 0-1-1,0:0:0.0
HOST-RESOURCES-MIB::hrFSLastFullBackupDate.4 = STRING: 0-1-1,0:0:0.0
HOST-RESOURCES-MIB::hrFSLastFullBackupDate.5 = STRING: 0-1-1,0:0:0.0
HOST-RESOURCES-MIB::hrFSLastFullBackupDate.6 = STRING: 0-1-1,0:0:0.0
HOST-RESOURCES-MIB::hrFSLastFullBackupDate.10 = STRING: 0-1-1,0:0:0.0
HOST-RESOURCES-MIB::hrFSLastFullBackupDate.12 = STRING: 0-1-1,0:0:0.0
HOST-RESOURCES-MIB::hrFSLastFullBackupDate.13 = STRING: 0-1-1,0:0:0.0
HOST-RESOURCES-MIB::hrFSLastFullBackupDate.14 = STRING: 0-1-1,0:0:0.0
HOST-RESOURCES-MIB::hrFSLastFullBackupDate.15 = STRING: 0-1-1,0:0:0.0
HOST-RESOURCES-MIB::hrFSLastFullBackupDate.16 = STRING: 0-1-1,0:0:0.0
HOST-RESOURCES-MIB::hrFSLastFullBackupDate.17 = STRING: 0-1-1,0:0:0.0
HOST-RESOURCES-MIB::hrFSLastFullBackupDate.18 = STRING: 0-1-1,0:0:0.0
HOST-RESOURCES-MIB::hrFSLastFullBackupDate.19 = STRING: 0-1-1,0:0:0.0
HOST-RESOURCES-MIB::hrFSLastFullBackupDate.20 = STRING: 0-1-1,0:0:0.0
HOST-RESOURCES-MIB::hrFSLastFullBackupDate.21 = STRING: 0-1-1,0:0:0.0
HOST-RESOURCES-MIB::hrFSLastFullBackupDate.22 = STRING: 0-1-1,0:0:0.0
HOST-RESOURCES-MIB::hrFSLastFullBackupDate.23 = STRING: 0-1-1,0:0:0.0
HOST-RESOURCES-MIB::hrFSLastFullBackupDate.24 = STRING: 0-1-1,0:0:0.0
HOST-RESOURCES-MIB::hrFSLastFullBackupDate.25 = STRING: 0-1-1,0:0:0.0
HOST-RESOURCES-MIB::hrFSLastFullBackupDate.26 = STRING: 0-1-1,0:0:0.0
```

Complete SNMP WALK

```
#snmpwalk -v2c -c test 10.12.45.238 .1
```

SNMP Trap Server Configuration with IPv6 Address

Management VRF Configuration

Snmpwalk is performed by using IPv6 address. SNMP trap server is configured on the Router with IPv6 address.

Topology

Figure 40 shows the sample configuration of SNMP trap server.

Figure 40. SNMP trap server topology

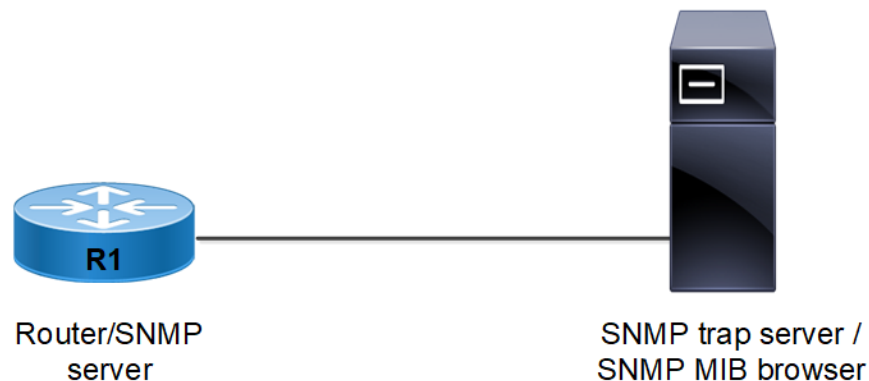

R1

#configure terminal	Enter configure mode.
(config)#snmp-server view all .1 included vrf	Configure SNMP server view

management	
(config)#snmp-server view test1 1.3.6.1 included vrf management	Configure SNMP server view
(config)#snmp-server user test1 network-admin auth md5 test1234 vrf management	Configure SNMP server user
(config)#snmp-server user test2 network-admin vrf management	Configure SNMP server user
(config)#snmp-server user test3 network-admin auth md5 test1234 priv des test1234 vrf management	Configure SNMP server user
(config)#snmp-server community test group network-operator vrf management	Configure SNMP server community
(config)#snmp-server host 2001:db8:100::2 traps version 2c test udp-port 162 vrf management host-vrf management	Configure SNMP trap server with default udp-port 162, the snmp-server running in management vrf as well as the host IP in management vrf
(config)#snmp-server host 1001:db8:0:2::1 traps version 1 test udp-port 6000 vrf management	Configure SNMP trap server with udp-port 6000, snmp-server running in management vrf and the host-IP in default vrf (can also mention host-vrf as default which is optional)
(config)#snmp-server host 8901:DB8:0:1::3 traps version 2c newcom udp-port 1025 vrf management host-vrf snmp-vrf	Configure SNMP trap server with udp-port 1025, snmp-server running in management vrf and the host-IP in user-defined vrf (snmp-vrf here)
(config)#interface eth0	Navigate to the interface mode
(config-if)#ipv6 address 2001:db8:100::5/64	Configure IPv6 address on the eth0 interface
(config-if)#exit	Exit interface configure mode
(config)#commit	Commit the candidate configuration to the running configuration
(config)#exit	Exit configure mode

Validation

Below is the SNMP configuration in Router node:

```
#show running-config snmp
snmp-server view all .1 included vrf management
snmp-server user test1 network-admin auth MD5 encrypt 0xd1fe6acc88856c90 vrf management
snmp-server user test2 network-admin vrf management
snmp-server user test3 network-admin auth MD5 encrypt 0xd1fe6acc88856c90 priv DES 0xd1fe6acc88856c90 vrf management
snmp-server community test group network-operator vrf management
snmp-server community test1 group network-admin vrf management
snmp-server enable snmp vrf management
snmp-server enable traps link linkDown
snmp-server enable traps link linkUp

#show ipv6 interface eth0 brief
Interface          IPv6-Address                               Admin-Status
-----          -
eth0              2001:db8:100::5                             [up/up]
                  fe80::218:23ff:fe30:e6ba
```

Perform snmpwalk as mentioned below with IPv6 address using SNMPv3

```
snmpwalk -v3 -u test3 -a MD5 -A test1234 -x DES -X test1234 -l authPriv 2001:db8:100::5
.1.3.6.1.2.1.25.3.8.1.8
```

Perform snmpwalk as mentioned below with IPv6 address using SNMPv2

```
snmpwalk -v2c -c test 2001:db8:100::5 1.3.6.1.2.1.31
```

Perform snmpwalk as mentioned below with IPv6 address using SNMPv1

```
snmpwalk -v1 -c test 2001:db8:100::5 1.3.6.1.2.1.31

#show snmp trap
```

```
-----
Trap type      Description      Enabled
-----
link           linkUp           yes
link           linkDown        yes
vxlan          notification     no
mpls           notification     no
mpls           pw              no
mpls           pw delete       no
mpls-l3vpn     notification     no
ospf           notification     no
ospf6          notification     no
isis           notification     no
snmp           authentication   no
mpls           rsvp            no
vrrp           notification     no
bgp            notification     no
```

As mentioned above, perform link down and link up of any interface in Router node. Check that SNMP trap is sent .

SNMP Informs with IPv6 Address over User Defined VRF

Snmpwalk is performed by using IPv6 address. SNMP trap server is configured on the Router with IPv6 address.

Topology

Shows the sample configuration of SNMP trap server.

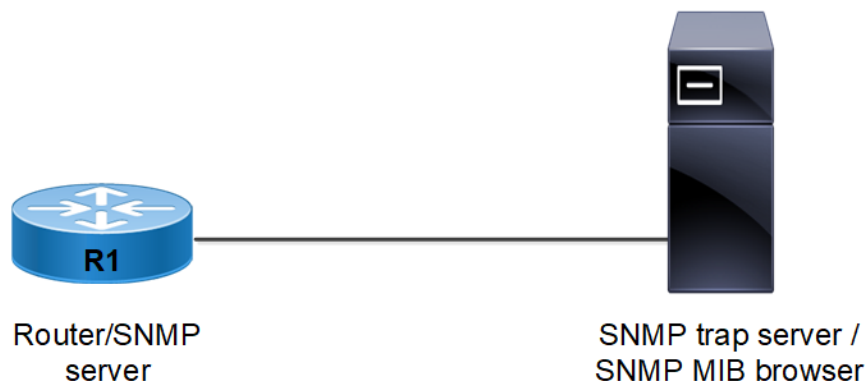

Figure 41. SNMP trap server topology

R1

#configure terminal	Enter configure mode.
(config)#ip vrf snmp-vrf	Creates a user-defined vrf called snmp-vrf
(config)#commit	Commit the candidate configuration to the running configuration
(config)#snmp-server view all .1 included vrf snmp-vrf	Configure SNMP server view
(config)#snmp-server view test1 1.3.6.1 included vrf snmp-vrf	Configure SNMP server view
(config)# snmp-server user newv3user auth sha AuthNewPass@123 priv aes PrivNewPass@123 vrf snmp-vrf	Configure SNMP server user
(config)#snmp-server community test group network-operator vrf snmp-vrf	Configure SNMP server community
(config)#snmp-server community test1 group network-admin vrf snmp-vrf	Configure SNMP server community
(config)# snmp-server host 8901:DB8:0:1::1 informs version 3 auth newv3user udp-port 60000 vrf snmp-vrf host-vrf snmp-vrf	Configure SNMP informs server with IPV6 address from a user-defined VRF ¹
(config)#interface xe0.6	Navigate to the interface mode
(config-if)#ipv6 address 8901:db8:0:1::2/64	Configure IPv6 address on the xe0.6 sub vlan interface
(config-if)#exit	Exit interface configure mode
(config)#commit	Commit the candidate configuration to the running configuration
(config)#exit	Exit configure mode

Validation

Below is the SNMP configuration in Router node:

```
#show running-config snmp
snmp-server view all .1 included vrf snmp-vrf
snmp-server view newview 1.3.6.1.2.1.6.13.1.1.127.0.0.1 excluded vrf snmp-vrf
snmp-server view test1 1.3.6.1 included vrf snmp-vrf
snmp-server user newv3user auth sha encrypt 0xd01d08043ea89bd3f77ccf8992973502 priv aes
0x7517e1def71063d7f77ccf8992973502 vrf snmp-vrf
snmp-server community newcom group network-operator vrf snmp-vrf
snmp-server community test group network-operator vrf snmp-vrf
snmp-server community test1 group network-admin vrf snmp-vrf
snmp-server host 172.18.19.22 traps version 2c newcom udp-port 162 vrf snmp-vrf
snmp-server host 172.18.19.20 informs version 3 auth newv3user udp-port 65535 vrf snmp-vrf
snmp-server host 8901:db8:0:1::1 informs version 3 auth newv3user udp-port 60000 vrf snmp-vrf
snmp-server enable snmp vrf snmp-vrf
snmp-server enable traps link linkDown
snmp-server enable traps link linkUp
snmp-server enable traps link include-interface-name
snmp-server enable traps vxlan
```

¹Virtual Routing and Forwarding

```

snmp-server enable traps pwdelete
snmp-server enable traps pw
snmp-server enable traps mpls
snmp-server enable traps mpls13vpn
snmp-server enable traps snmp authentication
snmp-server enable traps ospf
snmp-server enable traps bgp
snmp-server enable traps ospf6
snmp-server enable traps vrrp
snmp-server enable traps rsvp
snmp-server enable traps rib
snmp-server enable traps isis
snmp-server enable traps pim

#show ipv6 interface xe0.6 brief
Interface          IPv6-Address          Admin-Status
xe0.6              8901:db8:0:1::2
                  fe80::5e07:58ff:fe51:caea          [up/up]

```

Perform snmpwalk as mentioned below with IPv6 address using SNMPv3

```

snmpwalk -v3 -u newv3user -a SHA -A AuthNewPass@123 -x AES -X PrivNewPass@123 -l authPriv
8901:DB8:0:1::2 .1.3.6.1.2.1.25.3.8.1.8 -m all

```

Perform snmpwalk as mentioned below with IPv6 address using SNMPv2

```

snmpwalk -v2c -c newcom 8901:DB8:0:1::2 -t 5 -r 20 1.3.6.1.2.1.31 -Cp -Ct -m all

```

Perform snmpwalk as mentioned below with IPv6 address using SNMPv1

```

snmpwalk -v1 -c newcom 8901:DB8:0:1::2 -t 5 -r 20 1.3.6.1.2.1.31 -Cp -Ct -m all

#show snmp trap

```

```

-----
Trap type      Description      Enabled
-----
link           linkUp          yes
link           linkDown        yes
link           linkWithIfname yes
vxlan          notification    yes
mpls           notification    yes
mpls           pw              yes
mpls           pw delete      yes
mpls-13vpn     notification    yes
ospf           notification    yes
ospf6          notification    yes
isis           notification    yes
snmp           authentication  yes
mpls           rsvp            yes
pim            notification    yes
vrrp           notification    yes
rib            notification    yes
bgp            notification    yes

```

As mentioned above, perform link down and link up of any interface in Router node. Check that SNMP trap is sent.

SYSLOG MESSAGES OVER SNMP TRAPS

Topology

Shows the sample configuration of SNMP trap server.

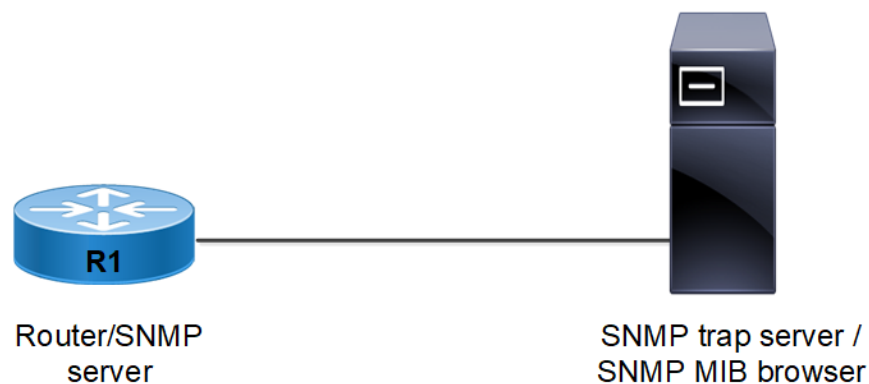
**R1**

#configure terminal	Enter configure mode.
(config)# snmpserver enable traps syslog	Enable sending syslog messages over SNMP
(config)# logging snmp-traps 7	Configure severity to select syslog messages sent over the SNMP
(config)# logging remote facility local4	Configure facility to select syslog messages sent over SNMP
(config)#snmp-server community test group network-operator vrf snmp-vrf	Configure SNMP server community
(config)# snmp-server host 8901:DB8:0:1::1 informs version 3 auth newv3user udp-port 60000 vrf snmp-vrf host-vrf snmp-vrf	Configure SNMP informs server with IPv4 address from a user-defined VRF
(config)#interface xe0.6	Navigate to the interface mode
(config-if)#ipv6 address 172.18.19.21/64	Configure IPv6 address on the xe0.6 sub vlan interface
(config-if)#exit	Exit interface configure mode
(config)#commit	Commit the candidate configuration to the running configuration
(config)#exit	Exit configure mode

Validation

Following is the SNMP configuration in Router node:

```
#show running-config snmp
snmp-server view all .1 included vrf snmp-vrf
snmp-server community test group network-operator vrf snmp-vrf
snmp-server host 172.18.19.20 informs version 2c test udp-port 5555 vrf snmp-vrf host-vrf snmp-vrf
snmp-server enable snmp vrf snmp-vrf
snmp-server enable traps link linkDown
snmp-server enable traps link linkUp
snmp-server enable traps link include-interface-name
snmp-server enable traps vxlan
snmp-server enable traps pwdelete
```

```

snmp-server enable traps pw
snmp-server enable traps mpls
snmp-server enable traps mpls13vpn
snmp-server enable traps snmp authentication
snmp-server enable traps ospf
snmp-server enable traps bgp
snmp-server enable traps ospf6
snmp-server enable traps vrrp
snmp-server enable traps rsvp
snmp-server enable traps rib
snmp-server enable traps isis
snmp-server enable traps pim
snmp-server enable traps syslog
#show ipv6 interface xe0.6 brief
Interface IP-Address Admin-Status Link-Status
xe0.6 172.18.19.21 up up

```

Perform a config-sync check from node and listen to the SNMP traps on the host via tcpdump:

```

S9600-28DX-1-5B#debug cml enable all
S9600-28DX-1-5B#cml config-sync check
2025 Feb 14 05:24:32 : S9600-28DX-1-5B : CMLSH : INFO : [CML_5]: Checking DB, this may take some time,
please wait...
# tcpdump -i any -n port 5555
tcpdump: verbose output suppressed, use -v or -vv for full protocol decode
listening on any, link-type LINUX_SLL (Linux cooked), capture size 262144 bytes
04:35:50.714406 IP 172.18.19.21.37155 > 172.18.19.20.5555: UDP1, length 268
04:35:50.714461 ethertype IPv4, IP 172.18.19.21.37155 > 172.18.19.20.5555: UDP, length 268
04:35:50.714461 IP 172.18.19.21.37155 > 172.18.19.20.5555: UDP, length 268
04:35:50.812648 ethertype IPv4, IP 172.18.19.21.37155 > 172.18.19.20.5555: UDP, length 268
04:35:50.812648 IP 172.18.19.21.37155 > 172.18.19.20.5555: UDP, length 268
04:35:50.813292 ethertype IPv4, IP 172.18.19.21.37155 > 172.18.19.20.5555: UDP, length 268
04:35:50.813292 IP 172.18.19.21.37155 > 172.18.19.20.5555: UDP, length 268

```

SNMP Traps Through different VRFs

From OcNOS 6.6.0 release onwards, SNMP traps can sent out through different VRFs.

The following example demonstrates that SNMP is configured in the management VRF, but traps can be sent from both the management and user_vrf1 VRFs. However, SNMP walk/get operations can only be performed on the management VRF.

#configure terminal	Enter configure mode.
(config)#ip vrf user_vrf1	Creates a user-defined vrf called user_vrf1
(config)#snmp-server view all .1 included vrf management	Configure SNMP server view
(config)#snmp-server enable snmp vrf management	Enable SNMP on management VRF
(config)#snmp-server community RegularTest group network-operator vrf management	Configure SNMP

¹User Datagram Protocol

	community
(config)#snmp-server location vrf management "Ottawa"	Configure location information
(config)#snmp-server contact vrf management "test@ipinfusion.com +1 819 776 6066"	Configure contact information
(config)#snmp-server host 172.29.7.144 traps version 2c RegularTest udp-port 3062 vrf management host-vrf management	Configure SNMP host on management VRF
(config)#snmp-server host 172.29.8.144 traps version 2c RegularTest udp-port 3062 vrf management host-vrf user_vrf1	Configure SNMP host on user-defined vrf user_vrf1

Similarly, SNMP service can be enabled on any one VRF, while the SNMP host can be configured on another VRF. SNMP traps/informs can be sent from the VRF configured for the host, but SNMP walk/get operations can only be performed on the VRF where the SNMP service is enabled. This applies to combinations of user-defined VRFs, the default VRF, and the management VRF.

Validation

```
#show running-config snmp
snmp-server view all .1 included vrf management
snmp-server community RegularTest group network-operator vrf management
snmp-server host 172.29.7.144 traps version 2c RegularTest udp-port 3062 vrf management host-vrf management
snmp-server host 172.29.8.144 traps version 2c RegularTest udp-port 3062 vrf management host-vrf user_vrf1
snmp-server location vrf management "Ottawa"
snmp-server contact vrf management "test@ipinfusion.com +1 819 776 6066"
snmp-server enable snmp vrf management
snmp-server enable traps link linkDown
snmp-server enable traps link linkUp
#show snmp host
-----
Host Port Version Level Type SecName VRF
-----
172.29.7.144 3062 2c noauth trap RegularTest management
172.29.8.144 3062 2c noauth trap RegularTest user_vrf1
```

| SNMP COMMAND REFERENCE

Simple Network Management Protocol	607
debug snmp-server	609
show running-config snmp	610
show snmp	611
show snmp community	612
show snmp context	613
show snmp engine-id	614
show snmp group	615
show snmp host	616
show snmp user	617
show snmp view	618
snmp context	619
snmp ent-ipi-iftable	620
snmp restart	621
snmp-server community	623
snmp-server community-map	625
snmp-server contact	626
snmp-server context	627
snmp-server disable default	628
snmp-server enable snmp	629
snmp-server enable traps	630
snmp-server engineID	632
snmp-server group	633
snmp-server host	635
snmp-server location	637
snmp-server smux-port-disable	638
snmp-server tcp-session	639
snmp ent-ipi-iftable	640
snmp-server user	641
snmp-server view	643

Simple Network Management Protocol

This chapter is a reference for Simple Network Management Protocol (SNMP) commands.

SNMP provides a standardized framework and a common language for monitoring and managing devices in a network. The SNMP framework consists of three parts:

- An SNMP manager: The system used to control and monitor the activities of network devices. This is sometimes called a Network Management System (NMS).
- An SNMP agent: The component within a managed device that maintains the data for the device and reports these data SNMP managers.
- Management Information Base (MIB): SNMP exposes management data in the form of variables which describe the system configuration. These variables can be queried by SNMP managers.

In SNMP, administration groups are known as *communities*. SNMP communities consist of one agent and one or more SNMP managers. You can assign groups of hosts to SNMP communities for limited security checking of agents and management systems or for administrative purposes. Defining communities provides security by allowing only management systems and agents within the same community to communicate.

A host can belong to multiple communities at the same time, but an agent does not accept a request from a management system outside its list of acceptable community names.

SNMP access rights are organized by groups. Each group is defined with three accesses: read access, write access, and notification access. Each access can be enabled or disabled within each group.

The SNMP v3 security level determines if an SNMP message needs to be protected from disclosure and if the message needs to be authenticated. The security levels are:

- noAuthNoPriv: No authentication or encryption
- authNoPriv: Authentication but no encryption
- authPriv: Both authentication and encryption.

SNMP is defined in RFCs 3411-3418.



Note: The commands below are supported on the “management” and default VRF¹.

This chapter contains these commands:

debug snmp-server	609
show running-config snmp	610
show snmp	611
show snmp community	612
show snmp context	613
show snmp engine-id	614
show snmp group	615
show snmp host	616

¹Virtual Routing and Forwarding

show snmp user	617
show snmp view	618
snmp context	619
snmp ent-ipi-iftable	620
snmp restart	621
snmp-server community	623
snmp-server community-map	625
snmp-server contact	626
snmp-server context	627
snmp-server disable default	628
snmp-server enable snmp	629
snmp-server enable traps	630
snmp-server engineID	632
snmp-server group	633
snmp-server host	635
snmp-server location	637
snmp-server smux-port-disable	638
snmp-server tcp-session	639
snmp ent-ipi-iftable	640
snmp-server user	641
snmp-server view	643

debug snmp-server

Use this command to display SNMP debugging information.

Use the `no` form of this command to stop displaying SNMP debugging information.

Command Syntax

```
debug snmp-server  
no debug snmp-server
```

Parameters

None

Default

Disabled

Command Mode

Execution mode and Configure mode

Applicability

This command was introduced before OcNOS version 1.3.

Example

```
#debug snmp-server
```

show running-config snmp

Use this command to display the SNMP running configuration.

Command Syntax

```
show running-config snmp
```

Parameters

None

Command Mode

Privileged execution mode

Applicability

This command was introduced before OcNOS version 1.3.

Example

```
#show running-config snmp
snmp-server view all .1 included
snmp-server community abc group network-admin
snmp-server enable snmp
```

show snmp

Use this command to display the SNMP configuration, including session status, system contact, system location, statistics, communities, and users.

Command Syntax

```
show snmp
```

Parameters

None

Command Mode

Execution mode

Applicability

This command was introduced before OcNOS version 1.3.

Examples

```
#show snmp
SNMP Protocol:Enabled
sys Contact:
sys Location:
-----
Community Group/Access Context acl_filter
-----
public network-admin
-----
SNMP USERS
-----
User Auth Priv(enforce) Groups
-----
SNMP Tcp-session :Disabled
```

show snmp community

Use this command to display SNMP communities.

Command Syntax

```
show snmp community
```

Parameters

None

Command Mode

Execution mode

Applicability

This command was introduced before OcNOS version 1.3.

Examples

```
#show snmp community  
  
-----  
Community Group/Access view-name version  
-----  
test network-operator  
testing network-operator ipi 2c
```

[Table 33](#) explains the output fields.

Table 33. show snmp community fields

Entry	Description
Community	SNMP Community string.
Group/Access	Community group name.
View-name	Community view name.
Version	Community version.

show snmp context

Use this command to display SNMP server contexts and associated groups.

Command syntax

```
show snmp context
```

Parameters

None

Command Mode

Execution mode

Applicability

This command is introduced in OcNOS version 5.1

Example

```
OcNOS#show snmp context
```

```
-----  
context groups  
-----
```

```
ctx1 grp1,grp2
```

```
ctx2 grp3
```

show snmp engine-id

Use this command to exhibit the SNMP engine identifier.

The SNMP engine identifier is a distinctive string employed to recognize the device for administrative purposes. The default engine-id is formulated using the MAC address, but an option for user-configured engine-id is also provided. The **show** command should be employed to retrieve information about the presently configured SNMP engine-id on the device.

Command Syntax

```
show snmp engine-id
```

Parameters

None

Command Mode

Execution mode

Applicability

This command was introduced prior to OcNOS version 1.3 and its display in the **show** output was enhanced in OcNOS version 6.3.2.

Examples

Default SNMP engine-id:

```
#show snmp engine-id
SNMP ENGINE-ID Type: MAC address
SNMP ENGINE-ID : 80 00 1f 88 03 e8 c5 7a 1a 02 1c
```

User-Configured engine-id:

```
#show snmp engine-id
SNMP ENGINE-ID Type: User configured Text
SNMP ENGINE-ID Text: ipinfusion
SNMP ENGINE-ID : 80 00 1f 88 04 69 70 69 6e 66 75 73 69 6f 6e
```

[Table 34](#) explains the output fields.

Table 34. show snmp engine-ip fields

Entry	Description
SNMP ENGINE-ID: 80 00 1f 88 04 69 70 69 6e 66 75 73 69 6f 6e	The SNMP engine identifier is a distinct string utilized to uniquely recognize the device for administrative purposes.

show snmp group

Use this command to display SNMP server groups and associated views.

Command Syntax

```
show snmp group
```

Parameters

None

Command Mode

Execution mode

Applicability

This command was introduced before OcNOS version 1.3.

Examples

```
#show snmp group
-----
community/user group version Read-View Write-view Notify-view
-----
test network-operator 2c/1 all all all
kedar network-operator 3 all none all
tamil network-operator 3 all none all
```

[Table 35](#) explains the output fields.

Table 35. show snmp group output

Entry	Description
Community/User	Displays the access type of the user for which the notification is generated.
Group	The name of the SNMP group, or collection of users that have a common access policy.
Version	SNMP version number.
Read-View	A string identifying the read view of the group. For further information on the SNMP views, use the <code>show snmp view</code> command.
Write-View	A string identifying the write view of the group.
Notify-View	A string identifying the notify view of the group. The notify view indicates the group for SNMP notifications, and corresponds to the setting of the <code>snmp-server group group-name version notify notify-view</code> command.

show snmp host

Use this command to display the SNMP trap hosts.

Command Syntax

```
show snmp host
```

Parameters

None

Command Mode

Execution mode

Applicability

This command was introduced before OcNOS version 1.3.

Examples

```
#show snmp host
-----
Host Port Version Level Type SecName
-----
10.10.26.123 162 2c noauth trap test
```

[Table 36](#) explains the output fields.

Table 36. Show snmp host output

Entry	Description
Host	The IP address of the SNMP host server.
Port	The port being used for SNMP traffic.
Version	SNMP version number.
Level	The security level being used.
Type	The type of SNMP object being sent.
SecName	Secure Name for this SNMP session.

show snmp user

Use this command to display SNMP users and associated authentication, encryption, and group.

Command Syntax

```
show snmp user
```

Parameters

None

Command Mode

Execution mode

Applicability

This command was introduced before OcNOS version 1.3.

Examples

```
#show snmp user
SNMP USERS

-----
User Auth Priv(enforce) Groups
-----
ntwadmin MD5 AES network-admin
#
```

[Table 37](#) explains the output fields.

Table 37. Show snmp user output

Entry	Description
User	The person attempting to use the SMNMP agent.
Auth	The secure encryption scheme being used.
Priv(enforce)	What enforcement privilege is being used (in this case, it is the Advance Encryption Standard).
Group	The group to which the user belongs.

show snmp view

Use this command to display SNMP views.

Command Syntax

```
show snmp view
```

Parameters

None

Command Mode

Execution mode

Applicability

This command was introduced before OcNOS version 1.3.

Examples

```
#show snmp view
View : all
OID : .1
View-type : included
```

snmp context

Use this command to associate the SNMP context with the **VRF**¹.

Use the **no** form of this command to remove the SNMP context association from VRF.

Command Syntax

```
snmp context-name WORD
no snmp context-name
```

Parameters

WORD

SNMP context name (Maximum 32 alphanumeric characters)

Default

No default value is specified.

Command Mode

Configure VRF mode

Applicability

This command was introduced before OcNOS version 6.1.0.

Examples

```
OcNOS#configure terminal
Enter configuration commands, one per line. End with CNTL/Z.
OcNOS(config)#ip vrf red
OcNOS(config-vrf)#snmp context-name context1
```

¹Virtual Routing and Forwarding

snmp ent-ipi-iftable

Use this command to enable the display of separate physical and logical interface tables in SNMP requests. Use the `no` form of this command to disable it.

Command Syntax

```
snmp ent-ipi-iftable
no snmp ent-ipi-iftable
```

Parameters

ent-ipi-iftable

Enables the physical and logical interface tables in SNMP requests.

Default

Disabled

Command Mode

Configure mode

Applicability

This command was introduced in OcNOS version 6.5.3.

Examples

```
OcNOS#configure terminal
OcNOS (config)#snmp ent-ipi-iftable
```

snmp restart

Use this command to restart SNMP for a given process.

Command Syntax

```
snmp restart (auth | bfd | bgp | isis | lacp| ldp | lldp | mrib | mstp | nsm | ospf | ospf6 | pim |  
rib| rip | rsvp |vrrp)
```

Parameters

auth

Authentication

bfd

Bidirectional Forwarding Detection (BFD)

bgp

Border Gateway Protocol (BGP)

isis

Intermediate System - Intermediate System (IS-IS)

lacp

Link Aggregation Control Protocol (LACP)

ldp

Label Distribution Protocol (LDP)

lldp

Link Layer Discovery Protocol (LLDP)

mrib

Multicast Routing Information Base (MRIB)

mstp

Multiple Spanning Tree Protocol (MSTP)

nsm

Network Service Module (NSM)

ospf

Open Shortest Path First (OSPFv2)

ospf6

Open Shortest Path First (OSPFv3)

pim

Protocol Independent Multicast (PIM)

rib

Routing Information Base (RIB)

rip

Routing Information Protocol (RIP)

rsvp

Resource Reservation Protocol (RSVP)

vrrp

Virtual Router Redundancy Protocol (VRRP)

Default

None

Command Mode

Configure mode

Applicability

This command was introduced before OcNOS version 1.3.

Examples

```
(config)#snmp restart nsm
```

snmp-server community

Use this command to create an SNMP community string and access privileges.

Use the `no` form of this command to remove an SNMP community string.

Command Syntax

```
snmp-server community WORD (| (view VIEW-NAME version (v1 | v2c ) ( ro)) |  
  (group (network-admin|network-operator)) |( ro) | (use-acl WORD) ) (vrf (NAME|management)|)  
no snmp-server community COMMUNITY-NAME (vrf (NAME|management)|)
```

Parameter

WORD

Name of the community (Maximum 32 alphanumeric characters)

VIEW-NAME

Name of the snmp view (Maximum 32 alphanumeric characters)

version

Set community string and access privileges

v1

SNMP v1

v2c

SNMP v2c

ro

Read-only access

group

Community group

network-admin

System configured group for read-only

network-operator

System configured group for read-only(default)

ro

Read-only access

use-acl

Access control list (ACL) to filter SNMP requests

WORD

ACL name; maximum length 32 characters

vrf management

Defines the management **VRF**¹ instance.

vrf NAME

Specify the user-defined VRF instance name.

¹Virtual Routing and Forwarding

Default

None

Applicability

This command was introduced before OcNOS version 1.3. Added VRF NAME parameter in OcNOS version 6.5.3.

Examples

```
#configure terminal
(config)#snmp-server community MyComm view MyView1 version v2c ro vrf management
```

snmp-server community-map

Use this command to map the community name with context and SNMPv2 user.

Use `no` form of this command to remove the community mapping.



Note: Community can be mapped with one context and user.

Command Syntax

```
snmp-server community-map WORD context WORD user WORD (vrf (NAME|management)|)
no snmp-server community-map WORD context WORD user WORD (vrf (NAME|management)|)
```

Parameters

WORD

SNMP community name

context

SNMP context name

WORD

Context string

user

SNMP user name

WORD

User string

vrf management Defines the management **VRF**¹ instance. vrf NAME Specify the user-defined VRF instance name.

Command Mode

Configure mode

Applicability

This command is introduced in OcNOS version 5.1 MR . Added VRF NAME parameter in OcNOS version 6.5.3.

Examples

```
OcNOS(config)#snmp-server community-map test context ctx2 user testing vrf management
```

¹Virtual Routing and Forwarding

snmp-server contact

Use this command to set the system contact information for the device (**sysContact** object).

Use the **no** form of this command to remove the system contact information.

Command Syntax

```
snmp-server contact (vrf (NAME|management)|) (TEXT|)
no snmp-server contact (vrf (NAME|management)|) (TEXT|)
```

Parameters

vrf management

Defines the management **VRF**¹ instance.

vrf NAME

Specify the user-defined VRF instance name.

TEXT

System contact information; maximum length 1024 characters without spaces

Default

None

Command Mode

Configure mode

Applicability

This command was introduced before OcNOS version 1.3. Added VRF NAME parameter in OcNOS version 6.5.3.

Examples

```
#configure terminal
(config)#snmp-server contact vrf management Irving@555-0150
```

¹Virtual Routing and Forwarding

snmp-server context

Use this command to create SNMP context.

Use `no` form of this command to remove the context.

Command Syntax

```
snmp-server context WORD (vrf (NAME|management) |)  
no snmp-server context WORD (vrf (NAME|management) |)
```

Parameters

context

SNMP context name

WORD

Context string (Maximum 32 alphanumeric characters)

vrf management Defines the management VRF¹ instance. **vrf NAME** Specify the user-defined VRF instance name.

Command Mode

Configure mode

Applicability

This command is introduced in OcNOS version 5.1MR. Added VRF NAME parameter in OcNOS version 6.5.3.

Examples

```
OcNOS(config)#snmp-server context ctx1 vrf management
```

¹Virtual Routing and Forwarding

snmp-server disable default

Use this command to disable default instance which is running on OcNOS device. After configuring this command user should not be able to enable default snmp instance. Use no form of this command to unset this after that only user should be able to configure default instance.

Command Syntax

```
snmp-server disable-default
```

Parameter

None

Default

None

Command Mode

Configure mode

Applicability

This command was introduced beforeOcNOS version 6.1.0.

Examples

```
#configure terminal  
(config)#snmp-server disable-default
```

snmp-server enable snmp

Use this command to start the SNMP agent daemon over **UDP**¹.

Use the **no** form of this command to stop the SNMP agent daemon over UDP.

Command Syntax

```
snmp-server enable snmp (vrf (NAME|management)|)
no snmp-server enable snmp (vrf (NAME|management)|)
```

Parameters

vrf management

Defines the management **VRF**² instance.

vrf NAME

Specify the user-defined VRF instance name.

Default

No default value specified.

Command Mode

Configure mode

Applicability

This command was introduced before OcNOS version 1.3. Added VRF NAME parameter in OcNOS version 6.5.3.

Examples

```
#configure terminal
(config)#snmp-server enable snmp vrf management
```

¹User Datagram Protocol

²Virtual Routing and Forwarding

snmp-server enable traps

Use this command to enable or disable SNMP traps and inform requests.



Note: For CMMD, Critical logs in the console are equivalent to Alert traps & Alert logs on the console is equivalent to critical trap in SNMP.

Command Syntax

```
snmp-server enable traps (link(|linkDown|linkUp|include-interface-name)|snmp(|authentication)|
mpls|pw|pwdelete|ospf|bgp|isis|vxlan|vrrp|ospf6|syslog)
no snmp-server enable traps (link(|linkDown|linkUp|include-interface-name)|snmp(|authentication)|
mpls|pw|pwdelete|ospf|bgp|isis|vxlan|vrrp|ospf6|syslog)
```

Parameters

bgp

bgp notification trap

isis

isis notification trap

link

Module notifications enable

linkDown

IETF Link state down notification

linkUp

IETF Link state up notification

snmp

Enable RFC 1157 notifications

syslog

Syslog notification trap

authentication

Send SNMP authentication failure notifications

mpls

mpls notification trap

mplsI3vpn

mpls-I3vpn notification trap

ospf

ospf notification trap

ospf6

ospf6 notification trap

pw

pw notification trap

pwdelete

pwdelete notification trap

rib

rib notification trap

rsvp

rsvp notification trap

vrrp

vrrp notification trap

vxlan

vxlan notification trap

linkDown

IETF link state down notification

linkup

IETF link state up notification

include-interface-name

Enable this option to include interface name in the Linkup/Linkdown trap's varbind

Default

By default, SNMP server traps are enabled.

Command Mode

Configure mode

Applicability

This command was introduced before OcNOS version 1.3 and was updated in OcNOS version 6.6.0.

Examples

```
(config)#snmp-server enable traps snmp
(config)#snmp-server enable traps mpls
(config)#snmp-server enable traps mpls13vpn
(config)#snmp-server enable traps rsvp
(config)#snmp-server enable traps ospf
(config)#snmp-server enable traps ospf6
(config)#snmp-server enable traps vrrp
(config)#snmp-server enable traps vxlan
(config)#snmp-server enable traps snmp authentication
(config)#snmp-server enable traps syslog
```

snmp-server engineID

Use this command to establish the SNMPv3 engine ID.

Use the no form of this command to remove the SNMPv3 engine ID.

Command Syntax

```
snmp-server engineID ENGINE_ID_STR  
no snmp-server engineID
```

Command Syntax

ENGINE_ID_STR

String of characters that uniquely identifies the SNMP engine ID.

Default

By Default the SNMP Server Engine ID value is automatically generated using the MAC address.

Command Mode

Configure mode

Applicability

This command was introduced before OcNOS version 6.3.2.

Examples

```
#configure terminal  
(config)#snmp-server engineID ipinfusion
```

snmp-server group

Use this command to create a SNMP group.

Use the **no** form of this command to remove the groups.

Command syntax

```
snmp-server group WORD version (1|2c) (context (all|WORD)|) (vrf (NAME|management)|) snmp-server
group WORD version 3 (auth|noauth|priv) (context (all|WORD)|) (vrf management|)
no snmp-server group WORD (context (all|WORD)|) (vrf (NAME|management)|)
```

Parameters

WORD

Specify the snmp group name (Maximum 32 alphanumeric characters)

version

SNMP Version

1

SNMP v1

2c

SNMP v2c

3

SNMP v3 security level

noauth

No authentication and no privacy (noAuthNoPriv) security model: messages transmitted as clear text providing backwards compatibility with earlier versions of SNMP

auth

Authentication and no privacy (authNoPriv) security model: use message digest algorithm (MD5) or Secure Hash Algorithm (SHA) for packet authentication; messages transmitted in clear text

priv

Authentication and privacy (authPriv) security model: use authNoPriv packet authentication with Data Encryption Standard (DES) Advanced Encryption Standard (AES) for packet encryption

context

SNMP context name

WORD

SNMP context string (Maximum 32 alphanumeric characters)

all

All context name's allowed for this group.

vrf management

Defines the management **VRF**¹ instance.

vrf NAME

Specify the user-defined VRF instance name.

¹Virtual Routing and Forwarding

Default

None

Command Mode

Configure mode

Applicability

This command is introduced in OcNOS version 5.1. Added VRF NAME parameter in OcNOS version 6.5.3.

Examples

```
OcNOS#con t
OcNOS(config)#snmp-server context ctx1 vrf management
OcNOS(config)#snmp-server group grp1 version 3 auth context ctx1 vrf management
OcNOS(config)#snmp-server group grp3 version 2c context ctx2 vrf management
```

snmp-server host

Use this command to configure an SNMP trap host. An SNMP trap host is usually a network management station (NMS) or an SNMP manager.

Use the **no** form of this command to remove an SNMP trap host.



Note: The maximum number of SNMP trap hosts is limited to 8.

Command Syntax

```
snmp-server host (A.B.C.D | X:X::X:X | HOSTNAME) ((traps version(( (1 | 2c) WORD ) | (3 (noauth |
auth | priv) WORD))) |(informs version ((2c WORD ) | (3 (noauth | auth | priv) WORD))))(|udp-port <1-
65535>) (vrf (NAME|management)|)
snmp-server host (A.B.C.D | X:X::X:X | HOSTNAME) WORD (|udp-port <1-65535>) (vrf (NAME|management)|)
snmp-server host (A.B.C.D | X:X::X:X | HOSTNAME) (version(( (1 | 2c) WORD ) | (3 (noauth | auth |
priv) WORD))) (|udp-port <1-65535>) (vrf (NAME|management)|)
no snmp-server host (A.B.C.D|X:X::X:X|HOSTNAME) (vrf (NAME|management)|)
```

Parameters

A.B.C.D

IPv4 address

X:X::X:X

IPv6 address

HOSTNAME

DNS host name

WORD

SNMP community string or SNMPv3 user name (Maximum 32 alphanumeric characters)

informs

Send notifications as informs

version

SNMP Version. Default notification is traps

<1-65535>

Host **UDP**¹ port number; the default is 162

vrf management

Defines the management **VRF**² instance.

vrf NAME

Specify the user-defined VRF instance name.

Virtual Routing and Forwarding name

traps

Send notifications as traps

version

Version

¹User Datagram Protocol

²Virtual Routing and Forwarding

1
SNMP v1

2c
SNMP v2c

WORD

SNMP community string (Maximum 32 alphanumeric characters)

3
SNMP v3 security level

noauth

No authentication and no privacy (noAuthNoPriv) security model: messages transmitted as clear text providing backwards compatibility with earlier versions of SNMP

auth

Authentication and no privacy (authNoPriv) security model: use message digest algorithm 5 (MD5) or Secure Hash Algorithm (SHA) for packet authentication; messages transmitted in clear text

priv

Authentication and privacy (authPriv) security model: use authNoPriv packet authentication with Data Encryption Standard (DES) Advanced Encryption Standard (AES) for packet encryption

WORD

SNMPv3 user name

Default

The default SNMP version is v2c and the default UDP port is 162. Simple Network Management Protocol.

Command Mode

Configure mode

Applicability

This command was introduced before OcNOS version 1.3 . Added VRF NAME parameter in OcNOS version 6.5.3.

Examples

```
#configure terminal
(config)#snmp-server host 10.10.10.10 traps version 3 auth MyUser udp-port 512
vrf management
```

snmp-server location

Use this command to set the physical location information of the device (**sysLocation** object).

Use the **no** form of this command to remove the system location information.

Command Syntax

```
snmp-server location (vrf (NAME|management)) (TEXT|)
no snmp-server location (vrf (NAME|management)) (TEXT|)
```

Parameters

vrf management Defines the management **VRFF**¹ instance. **vrf NAME** Specify the user-defined VRF instance name.

TEXT

Physical location information; maximum length 1024 characters

Default

No system location string is set.

Command Mode

Configure mode

Applicability

This command was introduced before OcNOS version 1.3 . Added VRF NAME parameter in OcNOS version 6.5.3.

Examples

```
#configure terminal
(config)#snmp-server location vrf management Bldg. 5, 3rd floor, northeast
```

¹Virtual Routing and Forwarding

snmp-server smux-port-disable

Use this CLI to disable the SMUX open port.

Command Syntax

```
snmp-server smux-port-disable
```

Parameters

None

Default

None

Command Mode

Configure mode

Applicability

This command is introduced in OcNOS version 5.1 release.

Examples

```
#configure terminal
#snmp-server smux-port-disable
```

snmp-server tcp-session

Use this command to start the SNMP agent daemon over TCP.

Use the `no` form of this command to close the SNMP agent daemon over TCP.

Command Syntax

```
snmp-server tcp-session (vrf (NAME|management)|)
no snmp-server tcp-session (vrf (NAME|management)|)
```

Parameters

vrf management

Defines the management **VRF**¹ instance.

vrf NAME

Specify the user-defined VRF instance name.

Default

Disabled

Command Mode

Configure mode

Applicability

This command was introduced before OcNOS version 1.3. Added `VRF NAME` parameter in OcNOS version 6.5.3.

Examples

```
#configure terminal
(config)#snmp-server tcp-session vrf management
```

¹Virtual Routing and Forwarding

snmp ent-ipi-iftable

Use this command to configure the trap caching settings for SNMP.

Use the `no` form of this command to disable caching for SNMP.

Command Syntax

```
snmp-server trap-cache (timeout <timeout> | max-count <max-count> | disable-ping |)  
no snmp-server trap-cache
```

Parameter

timeout <timeout>

Specifies the maximum time (in seconds) that traps will be cached before being sent. This sets the trap cache timeout.

max-count <max-trap-count>

Specifies the maximum number of traps that can be cached before they are flushed and sent.

disable-ping

Disables ping check for host availability. If ping is disabled, traps will be sent after the configured timeout.

Default

Disabled

Command Mode

Trap Cache mode

Applicability

This command was introduced in OcNOS version 6.5.3.

Examples

```
OcNOS#configure terminal  
OcNOS(config)#snmp-server trap-cache  
OcNOS(config-trap-cache)#timeout 60
```

snmp-server user

Use this command to create an SNMP server user.

Use the `no` form of this command to remove an SNMP server user.

Command Syntax

```
snmp-server user WORD ((network-operator|network-admin| WORD|) ((auth (md5 | sha
) (encrypt|) AUTH-PASSWORD) ((priv (des | aes) PRIV-PASSWORD) |) |) (vrf (NAME|management)|)
no snmp-server user USER-NAME (vrf (NAME|management)|)
```

Parameters

Word

Specify the snmp user name (Min 5 to Max 32 alphanumeric characters)network-operator|network-admin

Word

Name of the group to which the user belongs

auth.

Packet authentication type

md5

Message Digest Algorithm 5 (MD5)

sha

Secure Hash Algorithm(SHA)

priv

Packet encryption type("privacy")

des

Data Encryption Standard (DES)

aes

Advanced Encryption Standard (AES)

PRIV-PASSWORD

Encryption password; length 8-33 characters

encrypt

Specify authentication-password and/or privilege-password in encrypted form. This option is provided for reconfiguring a password using an earlier encrypted password that was available in running configuration display or get-config payload. Users are advised not to use this option for entering passwords generated in any other method.

vrf management

Defines the management **VRF**¹ instance.

vrf NAME

Specify the user-defined VRF instance name.

Default

Disabled

¹Virtual Routing and Forwarding

Command Mode

Configure mode

Applicability

This command was introduced before OcNOS version 1.3. Added VRF NAME parameter in OcNOS version 6.5.3.

Examples

```
#configure terminal
(config)#snmp-server user Fred auth md5 J@u-b;l2e`n,9p_ priv des t41VVb99i8He{Jt vrf management
```

snmp-server view

Use this command to create or update a view entry

Use the `no` form of this command to remove a view entry.



Note: OIDs to be excluded or included need to be specifically mentioned while configuring the SNMP view. Only when the OIDs are included will they be displayed in SNMP-Walk. When an OID is excluded, other OIDs must be explicitly included for the system to function.

Command Syntax

```
snmp-server view VIEW-NAME OID-TREE (included | excluded) (vrf (NAME|management)|)
no snmp-server view VIEW-NAME (vrf (NAME|management)|)
```

Parameters

VIEW-NAME

Name of the snmp view (Maximum 32 alphanumeric characters)

OID-TREE

Object identifier of a subtree to include or exclude from the view; specify a text string consisting of numbers and periods, such as 1.3.6.2.4

included

Include **OID-TREE** in the SNMP view

excluded

Exclude **OID-TREE** from the SNMP view

vrf management Defines the management VRF¹ instance. **vrf NAME** Specify the user-defined VRF instance name.

Default

Disabled

Command Mode

Configure mode

Applicability

This command was introduced before OcNOS version 1.3. Added VRF NAME parameter in OcNOS version 6.5.3.

Examples

The following example creates a view named `myView3` that excludes the `snmpCommunityMIB` object (1.3.6.1.6.3.18).

```
#configure terminal
```

¹Virtual Routing and Forwarding

```
(config)#snmp-server view myView3 1.3.6.1.6.3.18 excluded vrf management
```

LOGGING SERVER CONFIGURATION

Syslog Configuration	646
Overview	646
In-band Management over Default VRF	646
Syslog Configuration with IPv4 Address	646
Syslog Configuration with IPv6 Address	651
Custom Syslog Port Configuration	655
Overview	655
Support for In-band Management over default VRF	655
Features	655
Custom Syslog Configuration with IPv4 Address	655
Custom Syslog Configuration with IPv6 Address	657
Custom Syslog Configuration with HOSTNAME	659

Syslog Configuration

Overview

Syslog is a standard for logging program messages. It allows separation of the software that generates messages from the system that stores them and the software that reports and analyzes them. It also provides devices which would otherwise be unable to communicate, a means to notify administrators of problems or performance.

OcNOS supports logging messages to a syslog server in addition to logging to a file or the console (local or ssh/telnet console). OcNOS messages can be logged to a local syslog server (the machine on which OcNOS executes) as well as to one or more remote syslog servers (maximum of 8 remote syslog server is supported). Remote syslog servers can either be configured with IPv4 or IPv6 addresses or host names.

In-band Management over Default VRF

OcNOS supports syslog over the default and management VRFs via in-band management interface and OOB management interface, respectively.

By default, syslog runs on the management VRF¹.

Syslog Configuration with IPv4 Address

Logging is performed with IPv4 IP address and verified by logs on remote machine.

Topology

Figure 42. Syslog sample topology



Enabling rsyslog

```
#configure terminal | Enter configure mode.
```

¹Virtual Routing and Forwarding

(config)#feature rsyslog vrf management	Enable feature on default or management VRF ¹ . By default this feature runs on the management VRF.
(config)#commit	Commit the candidate configuration to the running configuration
(config)#exit	Exit configure mode

Logging to a File

The below configurations shows how to enable debug logs for a particular protocol. In this case, OSPF is shown.

#debug ospf all	This enables the debugging on OSPF.
#configure terminal	Enter configure mode
(config)#router ospf 1	Enable OSPF process 1
(config-router)#exit	Exit router mode
(config)#feature rsyslog	Enable syslog feature on default or management VRF ² . By default this feature runs on the management VRF.
(config)#logging level ospf 7	This enable debug messages for OSPF module. This is configurable either if default of management VRF.
(config)#logging logfile ospf1 7	This creates the log file where the logs will be saved. The path of the file will be in the directory /log/ospf1. Log File size 4096-4194304 bytes.
(config)#commit	Commit the candidate configuration to the running configuration
(config)#exit	Exit configure mode

To verify this, do some OSPF configuration and view the messages in the log file or with the **show logging logfile** command.

Validation

```
#show logging logfile

File logging : enabled File Name : /log/ospf1 Size : 419430400 Severity : (7)
2019 Jan 05 20:10:52.202 : OcNOS : OSPF : INFO : NSM Message Header
2019 Jan 05 20:10:52.202 : OcNOS : OSPF : INFO : VR ID: 0
2019 Jan 05 20:10:52.203 : OcNOS : OSPF : INFO : VRF ID: 0
2019 Jan 05 20:10:52.203 : OcNOS : OSPF : INFO : Message type: NSM_MSG_LINK_ADD
(5)
2019 Jan 05 20:10:52.203 : OcNOS : OSPF : INFO : Message length: 232
2019 Jan 05 20:10:52.203 : OcNOS : OSPF : INFO : Message ID: 0x00000000
2019 Jan 05 20:10:52.203 : OcNOS : OSPF : INFO : NSM Interface
2019 Jan 05 20:10:52.203 : OcNOS : OSPF : INFO : Interface index: 100001
2019 Jan 05 20:10:52.203 : OcNOS : OSPF : INFO : Name: po1
2019 Jan 05 20:10:52.204 : OcNOS : OSPF : INFO : Flags: 536875010
2019 Jan 05 20:10:52.204 : OcNOS : OSPF : INFO : Status: 0x00000804
2019 Jan 05 20:10:52.204 : OcNOS : OSPF : INFO : Metric: 1
2019 Jan 05 20:10:52.207 : OcNOS : OSPF : INFO : MTU: 1500
```

¹Virtual Routing and Forwarding

²Virtual Routing and Forwarding

```

2019 Jan 05 20:10:52.207 : OcNOS : OSPF : INFO : Type: L3
2019 Jan 05 20:10:52.207 : OcNOS : OSPF : INFO : HW type: 9
2019 Jan 05 20:10:52.208 : OcNOS : OSPF : INFO : HW len: 6
2019 Jan 05 20:10:52.209 : OcNOS : OSPF : INFO : HW address: ecf4.bb5c.a2b0
2019 Jan 05 20:10:52.210 : OcNOS : OSPF : INFO : Bandwidth: 0.000000
2019 Jan 05 20:10:52.211 : OcNOS : OSPF : INFO : Interface lacp key flag 0
2019 Jan 05 20:10:52.212 : OcNOS : OSPF : INFO : Interface lacp aggregator update flag 0

```

```
#show logging level
```

Facility	Default Severity	Current Session Severity
nsm	3	3
ripd	3	3
ospfd	3	7
ospf6d	3	3
isisd	3	3
hostpd	3	3
ldpd	2	2
rsvpd	2	2
mribd	2	2
pimd	2	2
authd	2	2
mstpd	2	2
imi	2	2
onmd	2	2
oamd	2	2
vlogd	2	2
vrrpd	2	2
ribd	2	2
bgpd	3	3
l2mribd	2	2
lagd	2	2
sflow	2	2
pservd	2	2

Validation

```

#show logging server
Remote Servers:
  10.16.2.1
      severity: (debugging)
      facility: local7
      VRF: management
  172.18.19.22
      severity: Operator (debug-detailed)
      facility: local7
      authpriv: Enabled
      VRF : snmp-vrf

```

```
#show logging level
```

Facility	Default Severity	Current Session Severity
nsm	3	3
ripd	3	3
ospfd	3	3
ospf6d	3	3
isisd	3	3
hostpd	3	3
ldpd	2	2
rsvpd	2	2
mribd	2	2
pimd	2	2
authd	2	2
mstpd	2	2
imi	2	2
onmd	2	2

```

oamd                2                2
vlogd               2                2
vrrpd              2                2
ribd                2                2
bgpd                3                7
l2mribd            2                2
lagd                2                2
sflow               2                2
pservd             2                2

```

Logging to the Console



Note: For CMMDD, Critical logs in the console are equivalent to Alert traps and Alert logs on the console is equivalent to critical trap in SNMP.

#configure terminal	Enter configure mode.
(config)#logging level ospf 7	This enable debug messages for OSFP module.
(config)#logging console 7	This enables the console logs.
(config)#debug ospf	This enables the debugging on OSPF configurations.
(config)#router ospf	Enabling ospf for process 1.
(config-router)#exit	Exit router mode.
(config)#commit	Commit the candidate configuration to the running configuration
(config)#exit	Exit configure mode.

To verify this, do some OSPF configuration and view the messages in the console.

Validation

```

#show logging console
Console logging      : enabled Severity: (debugging)

#show logging level

Facility           Default Severity      Current Session Severity
nsm                 3                      3
ripd                3                      3
ospfd               3                      7
ospf6d              3                      3
isisd               3                      3
hostpd              3                      3
mribd               2                      2
pimd                2                      2
authd               2                      2
mstpd               2                      2
imi                 2                      2
onmd                2                      2
oamd                2                      2
vlogd               2                      2
vrrpd              2                      2
ribd                2                      2
bgpd                3                      3
l2mribd            2                      2
lagd                2                      2
sflow               2                      2
pservd             2                      2

```

Logging to a Remote Server Via Management VRF

Use this command to set a syslog server.

OcNOS supports logging messages to a syslog server in addition to logging to a file or the console (local or SSH/telnet console). OcNOS messages can be logged to a local syslog server (the machine on which OcNOS executes) as well as to one or more remote syslog servers.

Use the **no** form of this command to remove a syslog server.



Note: Maximum 8 remote log servers can be configured.

Logging to Remote Server via User-Defined VRF

#configure terminal	Enter configure mode.
(config)#ip vrf snmp-vrf	Create a user-defined VRF ¹ called snmp-vrf.
(config)#commit	Commit the candidate configuration to the running configuration.
(config)#logging level bgp 7	Redirects the log messages to the server configured over the management VRF.
(config)#logging remote server 10.16.2.1 vrf management	Redirects the log messages to the server configured over the User defined VRF snmp-vrf.
(config)#debug bgp all	This enables the debugging on BGP con-figurations.
(config)#router bgp 1	Enabling BGP process 1.
(config-router)#exit	Exit router mode.
(config)#commit	Commit the candidate configuration to the running configuration
(config)#exit	Exit configure mode.

Validation

```
#show logging server
Remote Servers:
  10.16.2.1
      severity: (debugging)
      facility: local7
      VRF: management
  172.18.19.22
      severity: Operator (debug-detailed)
      facility: local7
      authpriv: Enabled
      VRF : snmp-vrf

#show logging level

Facility      Default Severity      Current Session Severity
nsm           3                    3
ripd          3                    3
ospfd         3                    3
```

¹Virtual Routing and Forwarding

ospf6d	3	3
isisd	3	3
hostpd	3	3
ldpd	2	2
rsvpd	2	2
mribd	2	2
pimd	2	2
authd	2	2
mstpd	2	2
imi	2	2
onmd	2	2
oamd	2	2
vlogd	2	2
vrrpd	2	2
ribd	2	2
bgpd	3	7
l2mribd	2	2
lagd	2	2
sflow	2	2
pservd	2	2

Syslog Configuration with IPv6 Address

Logging is performed with IPv6 IP and verified by logs on remote PC (Logging server).

Topology

Figure 43 shows the sample configuration of Syslog.

Figure 43. Syslog Configuration topology



Enabling rsyslog

#configure terminal	Enter configure mode
(config)#feature rsyslog [vrf management]	Enable feature on default or management VRF ¹ . By default this feature runs on the management VRF.
(config)#commit	Commit the candidate configuration to the running configuration

¹Virtual Routing and Forwarding

(config)#exit	Exit configure mode
---------------	---------------------

Logging to a File

The below configurations shows how to enable debug logs for a particular protocol. In this case, OSPF is shown.

#debug ospf all	This enables the debugging on OSPF
#configure terminal	Enter configure mode
(config)#router ospf 1	Enable OSPF process 1
(config-router)#exit	Exit router mode
(config)#feature rsyslog	Enable feature on default or management VRF. By default this feature runs on the management VRF.
(config)#logging level ospf 7	This enable debug messages for OSPF module. This is configurable either if de-fault of management VRF.
(config)#logging logfile ospf1 7	This creates the log file where the logs will be saved. The path of the file will be in the directory /log/ospf1. Log File size 4096- 4194304 bytes
(config)#commit	Commit the candidate configuration to the running configuration
(config)#exit	Exit configure mode

Logging to Remote Server

#configure terminal	Enter configure mode.
(config)#logging level bgp 7	This enable debug messages for BGP module
(config)#logging remote server 10.16.2.1 vrf management	Redirects the log messages to the server configured.
(config)#debug bgp all	This enables the debugging on BGP configurations.
(config)#router bgp 1	Enabling BGP process 1.
(config-router)#exit	Exit router mode.
(config)#commit	Commit the candidate configuration to the running configuration
(config)#exit	Exit configure mode.

Validation

```
#show logging server
Remote Servers:
    2001::1
    severity: (debugging)
    facility: local7
    VRF: management
```

Logging to Remote Server via Management VRF

#configure terminal	Enter configure mode.
(config)#logging level bgp 7	This enable debug messages for BGP module.
(config)#logging remote server 10.16.2.1 vrf management	Redirects the log messages to the server configured.
(config)#debug bgp all	This enables the debugging on BGP configurations.
(config)#router bgp 1	Enabling BGP process 1.
(config-router)#exit	Exit router mode.
(config)#commit	Commit the candidate configuration to the running configuration
(config)#exit	Exit configure mode.

Validation

```
#show logging server
  Remote Servers:
    10.16.2.1
    severity: (debugging)
    facility: local7
    VRF: management

#show logging level

Facility      Default Severity      Current Session Severity
nsm           3                   3
ripd          3                   3
ospfd         3                   3
ospf6d        3                   3
isisd         3                   3
hostpd        3                   3
ldpd          2                   2
rsvpd         2                   2
mribd         2                   2
pimd          2                   2
authd         2                   2
mstpd         2                   2
imi           2                   2
onmd          2                   2
oamd          2                   2
vlogd         2                   2
vrrpd         2                   2
ribd          2                   2
bgpd          3                   7
l2mribd       2                   2
lagd          2                   2
sflow         2                   2
pservd        2                   2
```

Logging to Remote Server via User-Defined VRF

#configure terminal	Enter configure mode.
(config)#ip vrf VRF1	Create a user-defined VRF ¹ called VRF1.

¹Virtual Routing and Forwarding

(config)#commit	Commit the candidate configuration to the running configuration.
(config)#logging level bgp 7	Redirects the log messages to the server configured over the management VRF.
(config)#logging remote server 1001:db8:0:1::1 7 vrf VRF1	Redirects the log messages to the server configured over the User defined VRF snmp-vrf.
(config)#debug bgp all	This enables the debugging on BGP configurations.
(config)#router bgp 1	Enabling BGP process 1.
(config-router)#exit	Exit router mode.
(config)#commit	Commit the candidate configuration to the running configuration
(config)#exit	Exit configure mode.

Validation

```
#show logging server
Remote Servers:
1001:db8:0:1::1
severity: Operator (debug-detailed)
facility: local7
authpriv: Enabled
VRF : VRF1
```

Custom Syslog Port Configuration

Overview

OcNOS enables the establishment of a Syslog server by designating the logging server as XX.XX.XX.XXX. This configuration sends syslog messages via the default port, which is 514. However, utilizing the default port for the Syslog server is considered a security vulnerability.

Support for In-band Management over default VRF

OcNOS offers support for DNS over default and management VRFs via in-band management interface & OOB management interface, respectively.

The feature can be enabled to run on default and management **VRF**¹ simultaneously. By default, it runs on management VRF.

Features

- CLI is supported for user to configure custom syslog port.
- Once configured syslog conf file is updated with the configured port value.
- At the rsyslog server side, stop the running rsyslogd daemon using the command “systemctl stop rsyslog.service”
- Update /etc/rsyslog.conf file with syslog client configured port.
- Start the rsyslog daemon –using systemctl start rsyslog.service.
- Logs will redirect to syslog server through configured port.
- After un-configuring, the port logs will be sent to syslog remote server through default port 514, to receive the logs at server side, it also needs to be set back to default.
- Delete the custom Syslog port.

Custom Syslog Configuration with IPv4 Address

Logging is performed with IPv4 IP address and verified by logs on remote machine.

¹Virtual Routing and Forwarding

Topology

Figure 44. Syslog sample topology



Enabling rsyslog

<code>#configure terminal</code>	Enter configure mode.
<code>(config)#feature rsyslog [vrf management]</code>	Enable feature on default or management VRF ¹ . By default this feature runs on the management VRF.
<code>(config)#commit</code>	Commit the candidate configuration to the running configuration
<code>(config)#exit</code>	Exit configure mode
<code>(config)# logging remote server 10.12.33.211 7 port 8514 vrf management</code>	Redirect into the remote server configure the severity and custom port with vrf management (default custom port is 514).
<code>(config)#commit</code>	Commit the candidate configuration to the running configuration
<code>(config)#exit</code>	Exit configure mode

Validation

```
#show running-config logging
feature rsyslog vrf management
logging remote server 10.12.33.211 7 port 8514 vrf management

ocnos#show logging server
  Remote Servers:
    10.12.33.211
    port: 8514
    severity: Operator (debug-detailed)
    facility: local7
    VRF : management
```

Check the rsyslog messages in server

Server Path: `/var/log/OcNOS.log`

¹Virtual Routing and Forwarding

Sample Output

```

2023-08-25T12:36:56+05:30 OcNOS PSERV[1595]: 2023 Aug 25 12:36:56.982 : OcNOS : PSERV : DEBUG : Keep-
Alive message sent to systemd
2023-08-25T12:37:03+05:30 OcNOS HSL[4598]: 2023 Aug 25 12:37:03.610 : OcNOS : HSL : NOTIF : [IF_PKT_
ERRORS_4]: Oversized packets received on ge14 (1 packets)
2023-08-25T12:37:13+05:30 OcNOS HSL[4598]: 2023 Aug 25 12:37:13.610 : OcNOS : HSL : NOTIF : [IF_PKT_
ERRORS_4]: Oversized packets received on ge14 (1 packets)
2023-08-25T12:37:23+05:30 OcNOS HSL[4598]: 2023 Aug 25 12:37:23.610 : OcNOS : HSL : NOTIF : [IF_PKT_
ERRORS_4]: Oversized packets received on ge14 (1 packets)
2023-08-25T12:37:33+05:30 OcNOS HSL[4598]: 2023 Aug 25 12:37:33.610 : OcNOS : HSL : NOTIF : [IF_PKT_
ERRORS_4]: Oversized packets received on ge14 (1 packets)
2023-08-25T12:37:43+05:30 OcNOS HSL[4598]: 2023 Aug 25 12:37:43.611 : OcNOS : HSL : NOTIF : [IF_PKT_
ERRORS_4]: Oversized packets received on ge14 (1 packets)
2023-08-25T12:37:49+05:30 OcNOS sshd[11651]: Accepted password for ocnos from 192.168.230.131 port
57298 ssh2
2023-08-25T12:37:49+05:30 OcNOS sshd[11651]: pam_unix(sshd:session): session opened for user ocnos by
(uid=0)
2023-08-25T12:37:50+05:30 OcNOS sshd[11660]: Accepted password for ocnos from 192.168.230.131 port
57301 ssh2
2023-08-25T12:37:50+05:30 OcNOS sshd[11660]: pam_unix(sshd:session): session opened for user ocnos by
(uid=0)
2023-08-25T12:37:50+05:30 OcNOS CML[4875]: 2023 Aug 25 12:37:50.359 : OcNOS : CML : INFO : [CML_5]:
Client [cmlsh (/dev/pts/0)] established connection with CML server
2023-08-25T12:37:51+05:30 OcNOS CMLSH[11672]: 2023 Aug 25 12:37:51.214 : OcNOS : CMLSH : CLI_HIST :
User ocnos@/dev/pts/0 : CLI : terminal monitor
2023-08-25T12:37:53+05:30 OcNOS CMLSH[11672]: 2023 Aug 25 12:37:53.330 : OcNOS : CMLSH : CLI_HIST :
User ocnos@/dev/pts/0 : CLI : en *New User Login*
2023-08-25T12:37:53+05:30 OcNOS HSL[4598]: 2023 Aug 25 12:37:53.611 : OcNOS : HSL : NOTIF : [IF_PKT_
ERRORS_4]: Oversized packets received on ge14 (1 packets)
2023-08-25T12:37:55+05:30 OcNOS CMLSH[11672]: 2023 Aug 25 12:37:55.570 : OcNOS : CMLSH : CLI_HIST :
User ocnos@/dev/pts/0 : CLI : start-shell
2023-08-25T12:37:56+05:30 OcNOS PSERV[1595]: 2023 Aug 25 12:37:56.983 : OcNOS : PSERV : DEBUG : Keep-
Alive message sent to systemd
2023-08-25T12:37:58+05:30 OcNOS su: (to root) ocnos on pts/0
2023-08-25T12:37:58+05:30 OcNOS su: pam_unix(su-l:session): session opened for user root by ocnos
(uid=1000)
2023-08-25T12:38:03+05:30 OcNOS HSL[4598]: 2023 Aug 25 12:38:03.611 : OcNOS : HSL : NOTIF : [IF_PKT_
ERRORS_4]: Oversized packets received on ge14 (1 packets)
2023-08-25T12:38:13+05:30 OcNOS HSL[4598]: 2023 Aug 25 12:38:13.611 : OcNOS : HSL : NOTIF : [IF_PKT_
ERRORS_4]: Oversized packets received on ge14 (1 packets)
2023-08-25T12:38:17+05:30 OcNOS PSERV[1595]: 2023 Aug 25 12:38:17.201 : OcNOS : PSERV : CRITI :
Module: ospfd has closed connection with PSERVD.
2023-08-25T12:38:17+05:30 OcNOS CML[4875]: 2023 Aug 25 12:38:17.204 : OcNOS : CML : CRITI : Module
ospf disconnected with CML
2023-08-25T12:38:18+05:30 OcNOS PSERV[1595]: 2023 Aug 25 12:38:18.229 : OcNOS : PSERV : INFO :
Protocol pservd published protocol-module-down notification.
2023-08-25T12:38:18+05:30 OcNOS PSERV[1595]: 2023 Aug 25 12:38:18.241 : OcNOS : PSERV : DEBUG : pserv
SIGUER2 signal for module :ospfd
2023-08-25T12:38:18+05:30 OcNOS PSERV[1595]: 2023 Aug 25 12:38:18.242 : OcNOS : PSERV : DEBUG : Crash
Dump Directory not present
2023-08-25T12:38:20+05:30 OcNOS NSM[4639]: 2023 Aug 25 12:38:20.110 : OcNOS : NSM : DEBUG : G8031 :
nsm_g8031_sync : Sync PG info to ONMD
2023-08-25T12:38:20+05:30 OcNOS PSERV[1595]: 2023 Aug 25 12:38:20.116 : OcNOS : PSERV : NOTIF :
[WATCHDOG_PM_RECOVERED_4]: The module ospfd recovered from a critical error
2023-08-25T12:38:20+05:30 OcNOS PSERV[1595]: 2023 Aug 25 12:38:20.116 : OcNOS : PSERV : NOTIF :
Signal SIGUSR2 received and restarted module: ospfd
2019 Jan 05 20:10:52.212 : OcNOS : OSPF : INFO : Interface lacp aggregator update flag 0

```

Custom Syslog Configuration with IPv6 Address

Logging is performed with IPv6 IP and verified by logs on remote PC (Logging server).

Topology

Figure 45. Syslog Configuration topology



Enabling rsyslog

<code>#configure terminal</code>	Enter configure mode
<code>(config)#feature rsyslog [vrf management]</code>	Enable feature on default or management VRF ¹ . By default this feature runs on the management VRF.
<code>(config)#commit</code>	Commit the candidate configuration to the running configuration
<code>(config)#logging remote server 200:201::100:10 7 port 8514 vrf management</code>	Redirect into the remote server configure the severity and custom port with vrf management (default custom port is 514).
<code>(config)#commit</code>	Commit the candidate configuration to the running configuration
<code>(config)#exit</code>	Exit configure mode

Validation

```
ocnos#show running-config logging
feature rsyslog vrf management
logging remote server 200:201::100:10 7 port 8514 vrf management

#show logging server
  Remote Servers:
    200:201::100:10
    port: 8514
    severity: Operator (debug-detailed)
    facility: local7
    VRF : management
```

Check the rsyslog messages in server

Server Path:- /var/log/OcNOS.log

¹Virtual Routing and Forwarding

Sample Output

```
2023-08-25T12:36:56+05:30 OcNOS PSERV[1595]: 2023 Aug 25 12:36:56.982 : OcNOS : PSERV : DEBUG : Keep-Alive message sent to systemd
2023-08-25T12:37:03+05:30 OcNOS HSL[4598]: 2023 Aug 25 12:37:03.610 : OcNOS : HSL : NOTIF : [IF_PKT_ERRORS_4]: Oversized packets received on ge14 (1 packets)
2023-08-25T12:37:13+05:30 OcNOS HSL[4598]: 2023 Aug 25 12:37:13.610 : OcNOS : HSL : NOTIF : [IF_PKT_ERRORS_4]: Oversized packets received on ge14 (1 packets)
2023-08-25T12:37:23+05:30 OcNOS HSL[4598]: 2023 Aug 25 12:37:23.610 : OcNOS : HSL : NOTIF : [IF_PKT_ERRORS_4]: Oversized packets received on ge14 (1 packets)
2023-08-25T12:37:33+05:30 OcNOS HSL[4598]: 2023 Aug 25 12:37:33.610 : OcNOS : HSL : NOTIF : [IF_PKT_ERRORS_4]: Oversized packets received on ge14 (1 packets)
2023-08-25T12:37:43+05:30 OcNOS HSL[4598]: 2023 Aug 25 12:37:43.611 : OcNOS : HSL : NOTIF : [IF_PKT_ERRORS_4]: Oversized packets received on ge14 (1 packets)
2023-08-25T12:37:49+05:30 OcNOS sshd[11651]: Accepted password for ocnos from 192.168.230.131 port 57298 ssh2
2023-08-25T12:37:49+05:30 OcNOS sshd[11651]: pam_unix(sshd:session): session opened for user ocnos by (uid=0)
2023-08-25T12:37:50+05:30 OcNOS sshd[11660]: Accepted password for ocnos from 192.168.230.131 port 57301 ssh2
2023-08-25T12:37:50+05:30 OcNOS sshd[11660]: pam_unix(sshd:session): session opened for user ocnos by (uid=0)
2023-08-25T12:37:50+05:30 OcNOS CML[4875]: 2023 Aug 25 12:37:50.359 : OcNOS : CML : INFO : [CML_5]: Client [cmlsh (/dev/pts/0)] established connection with CML server
2023-08-25T12:37:51+05:30 OcNOS CMLSH[11672]: 2023 Aug 25 12:37:51.214 : OcNOS : CMLSH : CLI_HIST : User ocnos@/dev/pts/0 : CLI : terminal monitor
2023-08-25T12:37:53+05:30 OcNOS CMLSH[11672]: 2023 Aug 25 12:37:53.330 : OcNOS : CMLSH : CLI_HIST : User ocnos@/dev/pts/0 : CLI : en *New User Login*
2023-08-25T12:37:53+05:30 OcNOS HSL[4598]: 2023 Aug 25 12:37:53.611 : OcNOS : HSL : NOTIF : [IF_PKT_ERRORS_4]: Oversized packets received on ge14 (1 packets)
2023-08-25T12:37:55+05:30 OcNOS CMLSH[11672]: 2023 Aug 25 12:37:55.570 : OcNOS : CMLSH : CLI_HIST : User ocnos@/dev/pts/0 : CLI : start-shell
2023-08-25T12:37:56+05:30 OcNOS PSERV[1595]: 2023 Aug 25 12:37:56.983 : OcNOS : PSERV : DEBUG : Keep-Alive message sent to systemd
2023-08-25T12:37:58+05:30 OcNOS su: (to root) ocnos on pts/0
2023-08-25T12:37:58+05:30 OcNOS su: pam_unix(su-l:session): session opened for user root by ocnos (uid=1000)
2023-08-25T12:38:03+05:30 OcNOS HSL[4598]: 2023 Aug 25 12:38:03.611 : OcNOS : HSL : NOTIF : [IF_PKT_ERRORS_4]: Oversized packets received on ge14 (1 packets)
2023-08-25T12:38:13+05:30 OcNOS HSL[4598]: 2023 Aug 25 12:38:13.611 : OcNOS : HSL : NOTIF : [IF_PKT_ERRORS_4]: Oversized packets received on ge14 (1 packets)
2023-08-25T12:38:17+05:30 OcNOS PSERV[1595]: 2023 Aug 25 12:38:17.201 : OcNOS : PSERV : CRITI : Module: ospfd has closed connection with PSERVD.
2023-08-25T12:38:17+05:30 OcNOS CML[4875]: 2023 Aug 25 12:38:17.204 : OcNOS : CML : CRITI : Module ospf disconnected with CML
2023-08-25T12:38:18+05:30 OcNOS PSERV[1595]: 2023 Aug 25 12:38:18.229 : OcNOS : PSERV : INFO : Protocol pservd published protocol-module-down notification.
2023-08-25T12:38:18+05:30 OcNOS PSERV[1595]: 2023 Aug 25 12:38:18.241 : OcNOS : PSERV : DEBUG : pserv SIGUER2 signal for module :ospfd
2023-08-25T12:38:18+05:30 OcNOS PSERV[1595]: 2023 Aug 25 12:38:18.242 : OcNOS : PSERV : DEBUG : Crash Dump Directory not present
2023-08-25T12:38:20+05:30 OcNOS NSM[4639]: 2023 Aug 25 12:38:20.110 : OcNOS : NSM : DEBUG : G8031 : nsm_g8031_sync : Sync PG info to ONMD
2023-08-25T12:38:20+05:30 OcNOS PSERV[1595]: 2023 Aug 25 12:38:20.116 : OcNOS : PSERV : NOTIF : [WATCHDOG_PM_RECOVERED_4]: The module ospfd recovered from a critical error
2023-08-25T12:38:20+05:30 OcNOS PSERV[1595]: Signal SIGUSR2 received and restarted module: ospfd

2019 Jan 05 20:10:52.212 : OcNOS : OSPF : INFO : Interface lacp aggregator update flag 0
```

Custom Syslog Configuration with HOSTNAME

Logging is performed with IPv6 IP and verified by logs on remote PC (Logging server).

Topology

Figure 46. Syslog Configuration topology

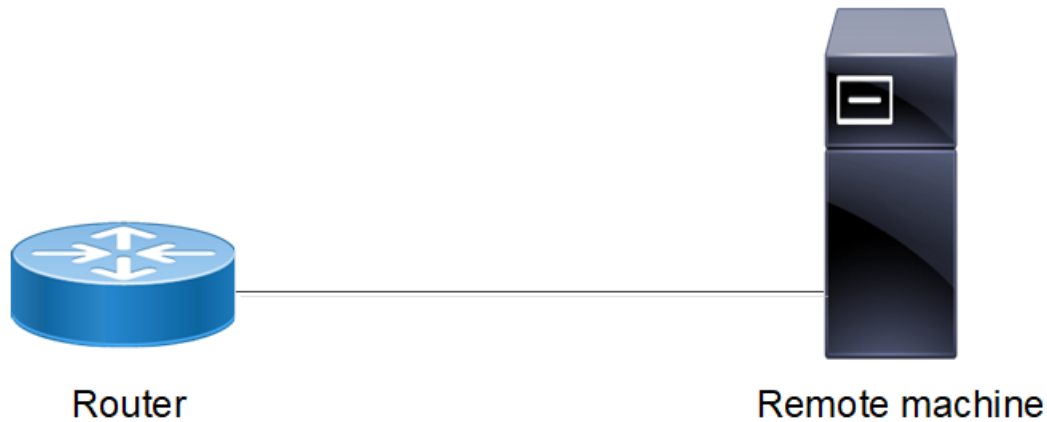

Enabling rsyslog

<code>#configure terminal</code>	Enter configure mode
<code>(config)#feature rsyslog [vrf management]</code>	Enable feature on default or management VRF ¹ . By default this feature runs on the management VRF.
<code>(config)#commit</code>	Commit the candidate configuration to the running configuration
<code>(config)#exit</code>	Exit configure mode
<code>(config)#hostname CUSTOM-SYSLOG</code>	Change the hostname to custom-syslog
<code>(config)#commit</code>	Commit the candidate configuration to the running configuration
<code>(config)#exit</code>	Exit configure mode
<code>(config)#logging remote server custom-syslog 7 port 8514 vrf management</code>	Redirect into the remote server configure the severity and custom port with vrf management (default custom port is 514).
<code>(config)#commit</code>	Commit the candidate configuration to the running configuration
<code>(config)#exit</code>	Exit configure mode

Validation

```
ocnos#show running-config logging
CUSTOM-SYSLOG#sh ru logging
feature rsyslog vrf management
logging remote server custom-syslog 7 port 8514 vrf management
CUSTOM-SYSLOG#

#show logging server
```

¹Virtual Routing and Forwarding

```

Remote Servers:
    custom-syslog
    port: 8514
    severity: Operator (debug-detailed)
    facility: local7
    VRF : management

```

Check the rsyslog messages in server

Server Path:- /var/log/OcnOS.log

Sample Output

```

2023-08-25T12:36:56+05:30 OcnOS PSERV[1595]: 2023 Aug 25 12:36:56.982 : OcnOS : PSERV : DEBUG : Keep-Alive message sent to systemd
2023-08-25T12:37:03+05:30 OcnOS HSL[4598]: 2023 Aug 25 12:37:03.610 : OcnOS : HSL : NOTIF : [IF_PKT_ERRORS_4]: Oversized packets received on ge14 (1 packets)
2023-08-25T12:37:13+05:30 OcnOS HSL[4598]: 2023 Aug 25 12:37:13.610 : OcnOS : HSL : NOTIF : [IF_PKT_ERRORS_4]: Oversized packets received on ge14 (1 packets)
2023-08-25T12:37:23+05:30 OcnOS HSL[4598]: 2023 Aug 25 12:37:23.610 : OcnOS : HSL : NOTIF : [IF_PKT_ERRORS_4]: Oversized packets received on ge14 (1 packets)
2023-08-25T12:37:33+05:30 OcnOS HSL[4598]: 2023 Aug 25 12:37:33.610 : OcnOS : HSL : NOTIF : [IF_PKT_ERRORS_4]: Oversized packets received on ge14 (1 packets)
2023-08-25T12:37:43+05:30 OcnOS HSL[4598]: 2023 Aug 25 12:37:43.611 : OcnOS : HSL : NOTIF : [IF_PKT_ERRORS_4]: Oversized packets received on ge14 (1 packets)
2023-08-25T12:37:49+05:30 OcnOS sshd[11651]: Accepted password for ocnos from 192.168.230.131 port 57298 ssh2
2023-08-25T12:37:49+05:30 OcnOS sshd[11651]: pam_unix(sshd:session): session opened for user ocnos by (uid=0)
2023-08-25T12:37:50+05:30 OcnOS sshd[11660]: Accepted password for ocnos from 192.168.230.131 port 57301 ssh2
2023-08-25T12:37:50+05:30 OcnOS sshd[11660]: pam_unix(sshd:session): session opened for user ocnos by (uid=0)
2023-08-25T12:37:50+05:30 OcnOS CML[4875]: 2023 Aug 25 12:37:50.359 : OcnOS : CML : INFO : [CML_5]: Client [cmlsh (/dev/pts/0)] established connection with CML server
2023-08-25T12:37:51+05:30 OcnOS CMLSH[11672]: 2023 Aug 25 12:37:51.214 : OcnOS : CMLSH : CLI_HIST : User ocnos@/dev/pts/0 : CLI : terminal monitor
2023-08-25T12:37:53+05:30 OcnOS CMLSH[11672]: 2023 Aug 25 12:37:53.330 : OcnOS : CMLSH : CLI_HIST : User ocnos@/dev/pts/0 : CLI : en *New User Login*
2023-08-25T12:37:53+05:30 OcnOS HSL[4598]: 2023 Aug 25 12:37:53.611 : OcnOS : HSL : NOTIF : [IF_PKT_ERRORS_4]: Oversized packets received on ge14 (1 packets)
2023-08-25T12:37:55+05:30 OcnOS CMLSH[11672]: 2023 Aug 25 12:37:55.570 : OcnOS : CMLSH : CLI_HIST : User ocnos@/dev/pts/0 : CLI : start-shell
2023-08-25T12:37:56+05:30 OcnOS PSERV[1595]: 2023 Aug 25 12:37:56.983 : OcnOS : PSERV : DEBUG : Keep-Alive message sent to systemd
2023-08-25T12:37:58+05:30 OcnOS su: (to root) ocnos on pts/0
2023-08-25T12:37:58+05:30 OcnOS su: pam_unix(su-l:session): session opened for user root by ocnos (uid=1000)
2023-08-25T12:38:03+05:30 OcnOS HSL[4598]: 2023 Aug 25 12:38:03.611 : OcnOS : HSL : NOTIF : [IF_PKT_ERRORS_4]: Oversized packets received on ge14 (1 packets)
2023-08-25T12:38:13+05:30 OcnOS HSL[4598]: 2023 Aug 25 12:38:13.611 : OcnOS : HSL : NOTIF : [IF_PKT_ERRORS_4]: Oversized packets received on ge14 (1 packets)
2023-08-25T12:38:17+05:30 OcnOS PSERV[1595]: 2023 Aug 25 12:38:17.201 : OcnOS : PSERV : CRITI : Module: ospfd has closed connection with PSERVD.
2023-08-25T12:38:17+05:30 OcnOS CML[4875]: 2023 Aug 25 12:38:17.204 : OcnOS : CML : CRITI : Module ospf disconnected with CML
2023-08-25T12:38:18+05:30 OcnOS PSERV[1595]: 2023 Aug 25 12:38:18.229 : OcnOS : PSERV : INFO : Protocol pservd published protocol-module-down notification.
2023-08-25T12:38:18+05:30 OcnOS PSERV[1595]: 2023 Aug 25 12:38:18.241 : OcnOS : PSERV : DEBUG : pserv SIGUER2 signal for module :ospfd
2023-08-25T12:38:18+05:30 OcnOS PSERV[1595]: 2023 Aug 25 12:38:18.242 : OcnOS : PSERV : DEBUG : Crash Dump Directory not present
2023-08-25T12:38:20+05:30 OcnOS NSM[4639]: 2023 Aug 25 12:38:20.110 : OcnOS : NSM : DEBUG : G8031 : nsm_g8031_sync : Sync PG info to ONMD
2023-08-25T12:38:20+05:30 OcnOS PSERV[1595]: 2023 Aug 25 12:38:20.116 : OcnOS : PSERV : NOTIF : [WATCHDOG_PM_RECOVERED_4]: The module ospfd recovered from a critical error
2023-08-25T12:38:20+05:30 OcnOS PSERV[1595]: Signal SIGUSR2 received and restarted module: ospfd
2019 Jan 05 20:10:52.212 : OcnOS : OSPF : INFO : Interface lacp aggregator update flag 0

```

LOGGING SERVER COMMAND REFERENCE

Syslog Commands	663
Syslog-Severities	664
clear logging logfile	667
feature rsyslog	668
logging console	669
logging level	670
logging logfile	673
logging monitor	675
logging remote facility	676
logging remote server	678
logging snmp-traps	680
logging timestamp	681
show logging	682
show logging last	684
show logging logfile	685
show logging logfile last-index	686
show logging logfile start-seqn end-seqn	687
show logging logfile start-time end-time	688
show running-config logging	690
VLOG Commands	691
show vlog all	692
show vlog clients	694
show vlog terminals	695
show vlog virtual-routers	696

Syslog Commands

This chapter is a reference for the `syslog` commands.

Linux applications use the `syslog` utility to collect, identify, time-stamp, filter, store, alert, and forward logging data. The `syslog` utility can track and log all manner of system messages from informational to extremely critical. Each system message sent to a `syslog` server has two descriptive labels associated with it:

- The function (facility) of the application that generated it. For example, an application such as `mail` and `cron` generates messages with a facility names “mail” and “cron”.
- Eight degrees of severity (numbered 0-7) of the message which are explained in [Table 38. Syslog severities \(page 664\)](#).

This chapter contains these commands:

Syslog-Severities	664
clear logging logfile	667
feature rsyslog	668
logging console	669
logging level	670
logging logfile	673
logging monitor	675
logging remote facility	676
logging remote server	678
logging snmp-traps	680
logging timestamp	681
show logging	682
show logging last	684
show logging logfile	685
show logging logfile last-index	686
show logging logfile start-seqn end-seqn	687
show logging logfile start-time end-time	688
show running-config logging	690

Syslog-Severities

In the example log entries in [Table 38. Syslog severities \(page 664\)](#), the prefixes are removed. For example, this is a complete log entry with the prefix:

```
2020 Apr 12 11:20:27.612 : 17U-18U : PSERV : MERG : !!! hsl Module crashed, System reboot halted as it rebooted continuously 2 times
```

This is the same log entry without the prefix:

```
hsl Module crashed, System reboot halted as it rebooted continuously 2 times
```

Table 38. Syslog severities

Severity Level	Keyword	Description
0	emergency	<p>The whole system is unusable and needs operator intervention to recover. If only a particular port or component is unusable, but the system as a whole is still usable it is not categorized at an emergency level.</p> <p>Examples of this type of message:</p> <pre>Output Power of PSU XX (psu_no) XX Watt] has exceeded Maximum Output Power Limit[XX Watt] OSPF Initialization failed.</pre>
1	alert	<p>The operator needs to act immediately or the system might go into emergency state. The system or one of its component's functionality might be critically affected.</p> <p>Examples of this type of message:</p> <pre>Temperature of sensor is (curr_temp)C. It is nearing Emergency Condition. OSPF has exceed lsdB limit OSPF Detected router with duplicate router ID [ID]</pre>
2	critical	<p>A critical system event happened which requires the operator's attention. The event might not require immediate action, but this event can affect functionality or behavior of a system component.</p> <p>Examples of this type of message:</p> <pre>OSPF Neighbor session went down. Interface %s changed state to down</pre>
3	error	<p>An error event happened which does not require immediate attention. This log message provides details about error conditions in the system or its components which you can use to troubleshoot problems.</p> <p>These events are not logged directly even if the logging level is set to include this level. You also need to enable the protocol debug filters (such as <code>debug ospf all</code>).</p> <p>Examples of this type of message:</p> <pre>Device i2c bus open error.!!! [DECODE] Attr ASPATH: Invalid AS Path value. OSPF MD5 authentication error</pre>

Table 38. Syslog severities (continued)

Severity Level	Keyword	Description
4	notification	<p>Notifications about important system and protocol events to assure the operator that the system is running properly. If a critical/alert condition has happened and has been corrected, that is also logged at this level.</p> <p>Examples of this type of message:</p> <pre>OSPF Received link up for interface: xe1 OSPF neighbour [10.1.1.1] Status change Exstart -> Exchange Interface %s changed state to UP</pre>
5	informational	<p>Detailed informational events happening across the system and protocol modules. These events are not necessarily important and are useful only to find details about the functionality being executed in the system and its components. Some of these events might be periodic events like hello or keep alive messages along with packet dumps. Also, this level includes logs for control packets that are ignored and do not impact the protocol states.</p> <p>IP Infusion Inc. recommends to use proper debug filters to log only relevant events and switch off other events; otherwise the logs can get verbose. For example:</p> <pre>debug ospf all no debug ospf packet hello</pre> <p>The above enables all OSPF debugging, but disables the periodic hello messages.</p> <p>Examples of this type of message:</p> <pre>Successfully added dynamic neighbour [DECODE] KAlive: Received! [FSM] Ignoring Unsupported event <EVENT> in state <STATE> Unknown ICMP¹ packet type" OSPF RECV[%s]: From %r via %s: Version number mismatch OSPF RECV[%s]: From %r via %s: Network address mismatch</pre>
6	debug informational	<p>Developer notification events that might not be readable by an operator. However these logs are useful for debugging by a developer and if required, this level needs to be enabled and provided to technical support for analysis.</p>
7	debug detailed	<p>Developer notification events that might not be readable by an operator. However these logs are useful for debugging by a developer and if required, this level needs to be enabled and provided to technical support for analysis.</p>

Log File Rotation

- Log rotation is important to maintain the stability of the device, because the larger log files are difficult to manipulate and file system would run out of space. The solution to this common problem is log file rotation.
- Log rotation is scheduled to happen for every 5 minutes, here the log file size is used as the condition to perform rotation.

¹Internet Control Message Protocol (ICMP) is a fundamental protocol used in networking to relay error messages and operational information.

- Log rotate operation creates a backup of the current log file, and clears the current log file content. Also these rotated log files are compressed to save disk space. Excluding the current log file, four backup files are maintained in the system, and the older logs are removed as part of the rotation operation.
- Default log file `/var/log/messages` rotated, if the size is greater than 100 MB. The following are the rotated log files generated in the path `/var/log`.

```
root@host:/var/log# ls messages*
messages messages.1 messages.2.gz messages.3.gz messages.4.gz
```

- Manually configured log file `/log/LOG1` gets rotated, if its size is greater than configured size. Here `LOG1` is the manually configured using the command `logging logfile <filename>` and the log file size in bytes can be configured using the command `logging logfile LOG1 <severity> size <4096-419430400>`

```
(config)#logging logfile LOG1 7 size 4096
```

- Here configured logging file `/log/LOG1` is rotated if the size is greater than 4096 bytes. The following are the rotated log files generated in the path `/log`

```
root@host:/log# ls LOG*
LOG1 LOG1.1 LOG1.2.gz LOG1.3.gz LOG1.4.gz
```

clear logging logfile

Use this command to clear the existing contents of the configured logging logfile.



Note: If the name of the configured logging log file is “mylogfile”, this command clears only the log file mylogfile. But the other rotated or compressed log files are untouched.

Command Syntax

```
clear logging logfile
```

Parameters

None

Default

None

Command Mode

Execution mode

Applicability

This command was introduced before OcNOS version 3.0.

Example

```
#clear logging logfile
```

feature rsyslog

Use this command to enable the rsyslog server.

Use the `no` form of this command to disable the rsyslog server.

Command Syntax

```
feature rsyslog vrf ( (NAME|management) | )  
no feature rsyslog vrf ( (NAME|management) | )
```

Parameters

vrf management

Defines the management **VRF**¹ instance.

vrf NAME

Specify the user-defined VRF instance name.

Default

None

Command Mode

Configure mode

Applicability

This command was introduced before OcNOS version 1.3. Added `VRF NAME` parameter in OcNOS version 6.5.3.

Example

```
#configure terminal  
(config)#feature rsyslog vrf management
```

¹Virtual Routing and Forwarding

logging console

Use this command to set the severity level that a message must reach before the messages is sent to the console. The severity levels are from 0 to 7 as shown in [Table 38. Syslog severities \(page 664\)](#)

Use the command `logging console disable` to disable logging console messages.

Use the `no` form of this command to remove logging console configuration and return to the default severity level.



Notes:

- Setting the level above 5 might affect performance and is not recommended in a production network.
- Below message will be displayed if console severity is set to 6 or 7:

```
% Warning : If debug volume is huge it can degrade system performance and makes console to be non-responsive
```
- For CMMD, Critical logs in the console are equivalent to Alert traps & Alert logs on the console is equivalent to critical trap in SNMP.

Command Syntax

```
logging console (<0-7>|)
logging console disable
no logging console
```

Parameters

<0-7>

Maximum logging level for console messages as shown in [Table 38. Syslog severities \(page 664\)](#).

disable

Disables the logging console

Default

If not specified, the default logging level is 2 (Critical).

Command Mode

Configure mode

Applicability

This command was introduced before OcNOS version 1.3 and the command `logging console disable` was introduced in the OcNOS version 5.1.

Example

```
#configure terminal
(config)#logging console 6
(config)#commit
(config)#logging console disable
(config)#commit
```

logging level

Use this command to set the severity level that a message for a specific process must reach before the messages is logged. The severity levels are from 0 to 7 as shown in [Table 38. Syslog severities \(page 664\)](#). Logging happens for the messages less than or equal to the configured severity level.

Use the **no** form of this command to disable logging messages.



Notes:

- Default log level is 2 to report Emergency-0, Alert-1 and Critical-2 level events.
- From OcNOS version 4.2, the behavior of the option **a11** for the logging level command has changed for the running-config. Now the command logging level **a11** is displayed in the running-config with its respective level defined by the user instead of one command for each process. If the user have some logging level configured for some specific process in the system when the logging level **a11** command is executed, the level of process that is already configured stays with the level and all other process are configured with the level defined by the **a11** option. This change is necessary to support the option **a11** for logging level in the Netconf also.

Command Syntax

```
logging level (all|auth|bgp|dvmrp|hostp|hsl|isis|l2mrib|lcp|lagd|mrib|
mstp|ndd|nsm|oam|ospf|ospf6|pim|pon|pservd|ptp|rib|rip|ripng|rmon|sflow|vrrp) <0-7>
no logging level (all|auth|bgp|dvmrp|hostp|hsl|isis|l2mrib|lcp|lagd|mrib|
mstp|ndd|nsm|oam|ospf|ospf6|pim|pon|pservd|ptp|rib|rip|ripng|rmon|sflow|vrrp)
```

Parameters

all

All messages

auth

Auth messages

bgp

BGP messages

dvmrp

DVMRP messages

hostp

Hostp messages

hsl

HSL messages

isis

ISIS messages

l2mrib

L2MRIB messages

lcp

LACP messages

lagd

LAGD messages

mrrib
MRIB messages

mstp
MSTP messages

ndd
NDD messages

nsm
NSM messages

oam
OAM messages

onm
ONM messages

ospf
OSPF messages

ospf6
OSPF6 messages

pim
PIM messages

pon
PON messages

pservd
PSERVD messages

ptp
PTP messages

rib
RIB messages

rip
RIP messages

ripng
RIPNG messages

rmon
RMON messages

sflow
Sflow messages

vrrp
VRRP messages

<0-7>
Severity level as shown in [Table 38. Syslog severities \(page 664\)](#).

Default

By default, the logging level is 2 (critical).

Command Mode

Configure mode

Applicability

This command was introduced before OcNOS version 1.3.

Examples

```
#configure terminal
(config)#logging level all 7
(config)#logging level ospf 3
(config)#logging level hostp 5

(config)#do show running-config logging
logging level ospf 3
logging level hostp 5
logging level all 7
feature rsyslog
```

logging logfile

Use this command to specify the log file controls and where to save the logs in a configuration file. This command enables writing debug output and command history to the disk file in the directory `/log/`.

When logging logfile is enabled, OcNOS log information is stored in user configured logging file which is present in `/log` directory. The log is spread across four files total of these files size is the user configured size.

For example, if the name of the logging log file is `mylogFile` and logging file size configured is 4 MB then each file will be maximum size of 1MB. The logging file names will be `mylogFile`, `mylogfile.0`, `mylogfile.1` and `mylogfile.2`.

`mylogFile` will have the latest log information. As soon as it's size becomes 1 MB this file is renamed as `mylogfile.0` and newlog information is written to new `mylogFile`. As a result oldest log information stored in `mylogfile.2` and is lost in order to accommodate new set of logs in `mylogFile`.

Use option `no` to cancel writing to a specific log file.



Note: Changing logfile parameters (name/size/severity) will be taken into effect for the next OcNOS session.

Command Syntax

```
logging logfile LOGFILENAME <0-7> ((size <4096-419430400>)|)
no logging logfile
```

Parameters

LOGFILENAME

Enter the logfile name (Maximum 200 alphanumeric characters).

<0-7>

Severity level as shown in [Table 38. Syslog severities \(page 664\)](#).

<4096-419430400>

Log file size in bytes.

Default

By default, log file size is 419430400 bytes.

Command Mode

Configure mode

Applicability

This command was introduced before OcNOS version 1.3.

Examples

This command is used to log the debug messages of a particular protocol daemon to the specified file.

```
#configure terminal
```



```
(config)#logging logfile test123 7
```

logging monitor

Use this command to set the severity level that a message must reach before a monitor message is logged. The severity levels are from 0 to 7 as shown in [Table 38. Syslog severities \(page 664\)](#).

Use the command `logging monitor disable` to disable the logging monitor messages.

Use the `no` form of this command to remove logging monitor config and return to the default severity level.



Note: Setting the level above 5 might affect performance and is not recommended in a production network.

Command Syntax

```
logging monitor (<0-7>|)
logging monitor disable
no logging monitor
```

Parameters

<0-7>

Maximum logging level for monitor messages as shown in [Table 38. Syslog severities \(page 664\)](#).

disable

Disables logging monitor

Default

If not specified, the default logging level is 7 (debug-details).

Command Mode

Configure mode

Applicability

This command was introduced before OcNOS version 1.3 and the command `logging monitor disable` was introduced in the OcNOS version 5.1.

Example

```
#configure terminal
(config)#logging monitor 6
(config)#commit
(config)#logging monitor disable
(config)#commit
```

logging remote facility

Use this command to set a syslog servers facility.

OcNOS supports logging messages to one or more remote syslog servers. but the same facility is used for all the servers.

Use the **no** form of this command to use the default facility value, which is **local7**.



Note: Only one facility is supported for all protocol modules across all the configured logging servers.

Command Syntax

```
logging remote facility (local0|local1|local2|local3|local4|local5|local6|local7|user)
no logging remote facility
```

Parameters

facility

Entity logging the message (user defined); if not specified, the default is local7

local0

Local0 entity

local1

Local1 entity

local2

Local2 entity

local3

Local3 entity

local4

Local4 entity

local5

Local5 entity

local6

Local6 entity

local7

Local7 entity (default)

user

User entity

Default

7

Command Mode

Configure mode

Applicability

This command was introduced in OcNOS version 4.1.

Examples

```
#configure terminal
(config)#logging remote facility local 6
(config)#no logging remote facility
```

logging remote server

Use this command to set a syslog server.

OcNOS supports logging messages to a syslog server in addition to logging to a file or the console (local or SSH/telnet console). OcNOS messages can be logged to a local syslog server (the machine on which OcNOS executes) as well as to one or more remote syslog servers.

Use the **no** form of this command to remove a syslog server.



Note: Maximum 8 remote log servers can be configured.

Command Syntax

```
logging remote server (A.B.C.D|X:X::X:X|HOSTNAME) ((0|1|2|3|4|5|6|7)|) (port <1024-65535>|) (vrf
management|)
no logging remote server (A.B.C.D|X:X::X:X|HOSTNAME) ((0|1|2|3|4|5|6|7)|) (port|) (vrf management|)
```

Parameters

A.B.C.D

IPv4 address

X:X::X:X

IPv6 address

HOSTNAME

Host name; specify localhost to log locally

0

Emergency

1

Alert

2

Critical

3

Error

4

Notification

5

Informational

6

Debug informational

7

Debug detailed

<1024-65535>

Port number Default port is 514

vrf management

Virtual Routing and Forwarding name



Note: Severity at which messages are logged as shown in [Table 38. Syslog severities \(page 664\)](#). If not specified, the default is 7.

Default

If not specified, the default severity at which messages are logged is 7 (debug detailed).

Command Mode

Configure mode

Applicability

This command was introduced in OcNOS version 6.4.

Examples

```
#configure terminal
(config)#logging remote server MyLogHost vrf management
(config)#no feature rsyslog vrf management
(config)# (config)#feature rsyslog
(config)#logging remote server 10.10.10.10 7
```



Note: In the latter configuration, the default **VRF**¹ does not need not to be specified in the command.

¹Virtual Routing and Forwarding

logging snmp-traps

Use this command to configure the severity of the SYSLOG over the SNMP trap feature, which will be used as a filter to the SYSLOG messages sent over the SNMP trap

Use the **no** form of this command to set the severity back to its default value.

Command Syntax

```
logging snmp-traps (<0-7>)  
no logging snmp-traps
```

Parameters

- 0 emergency
- 1 alert
- 2 critical
- 3 error
- 4 oper-notify/debug-warn
- 5 oper-info/debug-notify
- 6 debug-info
- 7 debug-details

Default

If not specified, severity will be set to 3 (error).

Command Mode

Configure mode

Applicability

This command was introduced in OcNOS version 6.6.0

Examples

```
#configure terminal  
(config)#logging snmp-traps 6  
(config)#commit  
(config)#no logging snmp-traps  
(config)#commit
```

logging timestamp

Use this command to set the logging timestamp granularity.

Use the `no` form of this command to reset the logging timestamp granularity to its default (milliseconds).



Notes:

- Any change in timestamp configurations will result in timestamp configured for event logged by protocol modules except for CLI history for the current and active sessions. The timestamp configuration is reflected in CLI history for new CLI sessions.
- Changing logging timestamp will be taken into effect for the next OcNOS session.

Command Syntax

```
logging timestamp (microseconds|milliseconds|seconds|none)
no logging timestamp
```

Parameters

microseconds

Microseconds granularity

milliseconds

Milliseconds granularity

seconds

Seconds granularity

none

No timestamp in log message

Default

By default, logging time stamp granularity is milliseconds.

Command Mode

Configure mode

Applicability

This command was introduced before OcNOS version 1.3.

Examples

```
#configure terminal
(config)#logging timestamp milliseconds
```

show logging

Use this command to display the logging configuration.

Command Syntax

```
show logging (info|level|server|console|timestamp|monitor)
```

Parameters

info

Show server logging configuration

level

Show facility logging configuration

server

Syslog server configuration

console

Console configuration

timestamp

Timestamp configuration

monitor

Monitor configuration

Command Mode

Execution mode

Applicability

This command was introduced before OcNOS version 1.3.

Examples

```
#show logging console
Console logging      : enabled Severity: Operator (critical) Level : 2

#show logging monitor
Logging monitor     : enabled Severity: Operator (debugging) Level: 7

#show logging server
Remote Servers:
    1.1.1.1
    severity: Operator (informational)
    facility: local7
    VRF : management

#sh logging info
Remote Servers:
    1.1.1.1
    severity: Operator (informational)
    facility: local7
    VRF : management
Logging console     : enabled Severity: operator (critical) Level : 2
```

```
Logging monitor      : enabled Severity: Operator (debugging) Level : 7
Logging timestamp   : seconds
File logging        : enabled File Name   : /log/abc Severity   : Operator (de
bugging) Level     : 7 Size      : 4194304
Cli logging         : enabled
```

Facility	Default	Severity	Current	Session	Severity
nsm		2		2	
ripd		2		2	
ripngd		2		2	
ospfd		2		2	
ospf6d		2		2	
isisd		2		2	
hostpd		2		2	
mribd		2		2	
pimd		2		2	
authd		2		2	
mstpd		2		2	
onmd		2		2	
HSL		2		2	
oamd		2		2	
vlogd		2		2	
vrrpd		2		2	
ndd		2		2	
ribd		2		2	
bgpd		2		2	
l2mribd		2		2	
hslrasmgr		2		2	
lagd		2		2	
pservd		2		2	
cmmd		2		2	

show logging last

Use this command to display lines from the end of the log file.

Command Syntax

```
show logging last (<1-9999>)
```

Parameters

<1-9999>

Number of lines to display from end of the log file

Command Mode

Execution mode

Applicability

This command was introduced before OcNOS version 1.3.

Examples

```
#show logging last 100
2016 Mar 03 00:02:32 x86_64-debian NSM-3: AgentX: failed to send open message: Connection refused
2016 Mar 03 00:02:33 x86_64-debian OSPF-3: AgentX: failed to send open message: Connection refused
2016 Mar 03 00:02:33 x86_64-debian OSPFv3-3: AgentX: failed to send open message: Connection refused
2016 Mar 03 00:02:33 x86_64-debian IS-IS-3: AgentX: failed to send open message: Connection refused
2016 Mar 03 00:02:33 x86_64-debian BGP-3: AgentX: failed to send open message: Connection refused
2016 Mar 03 00:02:33 x86_64-debian RIP-3: AgentX: failed to send open message: Connection refused
```

show logging logfile

Use this command to display whether logging is enabled, the log file name, and the logging severity.

Command Syntax

```
show logging logfile
```

Parameters

None

Command Mode

Execution mode

Applicability

This command was introduced before OcNOS version 1.3.

Examples

```
#show logging logfile
File logging      : enabled File Name      : /log/abc Severity   : (7)
2017 Sep 25 17:18:14 : : CMLSH : CLI_HIST : User root@/dev/ttyS1 : CLI : '
logging remote server 1.1.1.1 5 vrf management '
```



```
2017 Sep 25 17:18:14 : : CMLSH : CLI_HIST : User root@/dev/ttyS1 : CLI : '
ex'
```



```
2017 Sep 25 17:18:17 : : CMLSH : CLI_HIST : User root@/dev/ttyS1 : CLI : '
sh logging info '
```



```
2017 Sep 25 17:19:15 : : CMLSH : CLI_HIST : User root@/dev/ttyS1 : CLI : '
sh logging console '
```



```
2017 Sep 25 17:19:20 : : CMLSH : CLI_HIST : User root@/dev/ttyS1 : CLI : '
sh logging monitor '
```



```
2017 Sep 25 17:19:32 : : CMLSH : CLI_HIST : User root@/dev/ttyS1 : CLI : '
sh logging logfile '
```



```
2017 Sep 25 17:19:44 : : CMLSH : CLI_HIST : User root@/dev/ttyS1 : CLI : '
sh logging server '
```



```
2017 Sep 25 17:28:26 : : CMLSH : CLI_HIST : User root@/dev/ttyS1 : CLI : '
sh logging info '
```



```
2017 Sep 25 17:29:02 : : CMLSH : CLI_HIST : User root@/dev/ttyS1 : CLI : '
sh logging console
```

show logging logfile last-index

Use this command to display the number of line in the log file.

Command Syntax

```
show logging logfile last-index
```

Parameters

None

Command Mode

Execution mode

Applicability

This command was introduced before OcNOS version 1.3.

Examples

```
#show logging logfile last-index  
logfile last-index : 10
```

Here is the explanation of the show command output fields.

Table 39. show logging logfile last-index fields

Entry	Description
logfile last-index	Number of line in the logfile.

show logging logfile start-seqn end-seqn

Use this command to display a range of lines in the log file.

Command Syntax

```
show logging logfile start-seqn (<0-2147483647>) (| (end-seqn <0-2147483647>))
```

Parameters

start-seqn <0-2147483647>

Starting line number

end-seqn <0-2147483647>

Ending line number

Command Mode

Execution mode

Applicability

This command was introduced before OcNOS version 1.3.

Examples

```
#show logging logfile start-seqn 2 end-seqn 7
2
3 2019 Jan 04 06:20:49.611 : NE4-router : CMLSH : CLI_HIST : User root@/dev/ttyS0 : CLI : sh logging
logfile
4
5 2019 Jan 04 06:21:08.512 : NE4-router : CMLSH : CLI_HIST : User root@/dev/ttyS0 : CLI : show
logging logfile last-index
6
7 2019 Jan 04 06:21:16.246 : NE4-router : CMLSH : CLI_HIST : User root@/dev/ttyS0 : CLI : show
logging logfile last-index
NE4-router#
```

Here is the explanation of the show command output fields.

Table 40. show logging logfile start-seqn end-seqn fields

Entry	Description
start-seqn	Starting line number
end-seqn	Ending line number

show logging logfile start-time end-time

Use this command to display lines from the log file within a given date-time range.

Command Syntax

```
show logging logfile start-time (<2000-2030> WORD <1-31> WORD) (|end-time <2000-2030> WORD <1-31> WORD)
```

Parameters

start-time

Starting date and time:

<2000-2030>

Starting date of the year in YYYY format

WORD

Starting date of the month as **jan**, **feb**, **mar**,..., **oct**, **nov**, or **dec** (maximum length 3 characters)

<1-31>

Starting date of a day of month in DD format

WORD

Starting time in hour, minutes, and seconds in HH:MM:SS format (maximum length 8 characters); range <0-23>:<0-59>:<0-59>

end-time

Ending date and time:

<2000-2030>

Ending date of the year in YYYY format

WORD

Ending date the month as **jan**, **feb**, **mar**,..., **oct**, **nov**, or **dec** (maximum length 3 characters)

<1-31>

Ending date of a day of month in DD format

WORD

Ending time in hour, minutes, and seconds in HH:MM:SS format (maximum length 8 characters); range <0-23>:<0-59>:<0-59>

Command Mode

Execution mode

Applicability

This command was introduced before OcNOS version 1.3.

Examples

```
#sh logging logfile start-time 2019 Jan 04 06:20:49 end-time 2019 Jan 04 06:21:16
2019 Jan 04 06:20:49.611 : NE4-router : CMLSH : CLI_HIST : User root@/dev/ttyS0 : CLI : sh logging
logfile

2019 Jan 04 06:21:08.512 : NE4-router : CMLSH : CLI_HIST : User root@/dev/ttyS0 : CLI : show logging
```

```
logfile last-index
```

```
2019 Jan 04 06:21:16.246 : NE4-router : CMLSH : CLI_HIST : User root@/dev/ttyS0 : CLI : show logging  
logfile last-index
```

show running-config logging

Use this command to display the logging configuration.

Command Syntax

```
show running-config logging
```

Parameters

None

Command Mode

Execution mode and Configure mode

Applicability

This command was introduced before OcNOS version 1.3.

Examples

```
#show running-config logging
no Logging console
no Logging monitor
logging timestamp milliseconds
```

VLOG Commands

This chapter describes virtual router log (VLOG) commands.

show vlog all	692
show vlog clients	694
show vlog terminals	695
show vlog virtual-routers	696

show vlog all

Use this command to display the output of all virtual router log **show** commands. For column descriptions, refer to descriptions of the individual commands.

Command Syntax

```
show vlog all
```

Parameters

None

Default

None

Command Mode

Execution mode and Privileged execution mode

Applicability

This command was introduced before OcNOS version 1.3.

Example

```
>enable
#show vlog all

Type      Name      FD  UserVR  AllVrs  VRCnt
tty       /dev/pts/8  12  vr222   ---     1
tty       /dev/pts/4  13  <PVR>   ---     1

VR-Name   VR-Id   PVR-Terms  VR-Terms          LogFile              CurSize
<PVR>     0       1           0                 /var/local/zebos/log/pvr/my-log  1624320
vr111     1       0           0                 n/a                       n/a
vr222     2       0           1                 /var/local/zebos/log/vr222/log-vr222  0
vr333     3       0           0                 /var/local/zebos/log/vr333/log-vr333  0

Name      Id      MsgCnt      ConTime              ReadTime
NSM       1       1           Fri May-15 21:05:04  Fri May-15 21:05:04
IMI       19      1           Fri May-15 21:05:02  Fri May-15 21:05:02
```

The following table explains the output:

Table 41. show vlog all details

Name	Name of protocol module
Id	Protocol module identifier
MsgCnt	Number of log messages received from protocol module
ConTime	Time the connection was established
ReadTime	Time the last log message was received

The following table explains the output:

Table 42. show vlog all details

Type	Type of terminal
Name	Device name
FD	File descriptor
UserVR	Name of the Virtual Router where in which the user is logged in
AllVRs	Whether the PVR user requested debug output from all VRs
VRCnt	Number of VRs to which a terminal is attached

The following table explains the output:

Table 43. show vlog all details

VR-Name	Virtual router name
VR-Id	Virtual router identifier
PVR-Terms	Number of attached PVR terminals
VR-Terms	Number of attached VR terminals
LogFile	Name of VR log file (this column is empty if writing to a log file is disabled)
CurSize	Log file current size

show vlog clients

Use this command to display all attached virtual router log clients (protocol modules).

Command Syntax

```
show vlog clients
```

Parameters

None

Default

None

Command Mode

Privileged execution mode

Applicability

This command was introduced before OcNOS version 1.3.

Example

```
>enable
#show vlog clients

Name  Id  MsgCnt          ConTime          ReadTime
NSM   1   1      Fri May-15 21:05:04  Fri May-15 21:05:04
IMI  19   1      Fri May-15 21:05:02  Fri May-15 21:05:02
```

The following table explains the output fields for show vlog clients details:

Table 44. show vlog clients details

Name	Name of protocol module
Id	Protocol module identifier
MsgCnt	Number of log messages received from protocol module
ConTime	Time the connection was established
ReadTime	Time the last log message was received

show vlog terminals

Use this command to display all active connections where VLOGD is forwarding log output.

Command Syntax

```
show vlog terminals
```

Parameters

None

Default

None

Command Mode

Privileged execution mode

Applicability

This command was introduced before OcNOS version 1.3.

Example

```
>enable
#show vlog terminals

Type      Name      FD  UserVR  AllVrs  VRCnt
tty       /dev/pts/8  12  vr222   ---     1
tty       /dev/pts/4  13  <PVR>   ---     1
```

The following table explains the output:

Table 45. show virtual router log terminals details

Type	Type of terminal
Name	Device name
FD	File descriptor
UserVR	Name of the Virtual Router where in which the user is logged in
AllVRs	Whether the PVR user requested debug output from all VRs
VRCnt	Number of VRs to which a terminal is attached

show vlog virtual-routers

Use this command to display virtual router statistics such as the number of terminals attached.

Command Syntax

```
show vlog virtual-routers
```

Parameters

None

Default

None

Command Mode

Privileged execution mode

Applicability

This command was introduced before OcNOS version 1.3.

Example

```
>enable
#show vlog virtual-routers

VR-Name  VR-Id  PVR-Terms  VR-Terms  LogFile                               CurSize
<PVR>    0  1          0          /var/local/zebos/log/pvr/my-log        1624320
vr111    1  0          0          n/a                                     n/a
vr222    2  0          1          /var/local/zebos/log/vr222/log-vr222   0
vr333    3  0          0          /var/local/zebos/log/vr333/log-vr333   0
```

The following table explains the output:

Table 46. show vlog virtual-routers details

VR-Name	Virtual router name
VR-Id	Virtual router identifier
PVR-Terms	Number of attached PVR terminals
VR-Terms	Number of attached VR terminals
LogFile	Name of VR log file (this column is empty if writing to a log file is disabled)
CurSize	Log file current size

MONITOR AND REPORTING SERVER CONFIGURATION

Software Monitoring and Reporting	698
Overview	698
Configuration	699
Validation	699
Configure sFlow for Single Collector	700
Overview	700
Topology	701
Configuration	701
Configure sFlow for Multiple Collectors	703
Overview	703
Prerequisites	703
sFlow Configuration	704
Control Plane Policing Configuration	708
Topology	708
Configuring CPU Queuing Lossless	711
Configuring CPU Queuing Lossy	712

Software Monitoring and Reporting

Overview

OcNOS provides a mechanism (called “watchdogging”) to monitor all OcNOS modules and provides the following functions.

1. Periodic heart beat check.
2. Automatic restarts of a module upon a hung state or crash detection.
3. Upon hanging or crashing of a module, a crash report (including system states) is logged.
4. A proprietary SNMP trap is sent to the trap manager, if configured, after a fault is detected in a protocol module. Similarly a trap is sent when the module recovers.

By default, the software watchdog is enabled and the keep-alive time interval is 60 seconds. All OcNOS processes periodically send keep-alive messages to a monitoring module at the configured keep-alive time interval.

This functionality can be disabled for a particular module or all OcNOS modules by using CLI commands. In order to permanently disable software monitoring functionality, the user has to disable the watchdog feature. If, however, software watchdogging is disabled the monitoring module doesn't take any action upon a hang or crash of any OcNOS module.

Configuration

<code>#configure terminal</code>	Enter Configure mode.
<code>(config)#feature software-watchdog</code>	Enable software watchdog for all OcNOS modules — This is the default.
<code>(config)#no software-watchdog imi</code>	To disable software watchdog for only imi modules.
<code>(config)#software-watchdog keep-alive-time 100</code>	The keep-alive time interval in seconds. Default is 60 seconds and applies to all OcNOS modules.
<code>(config)#show software-watchdog status</code>	Display the keep-alive time interval and list of OcNOS process names with watchdog status for each OcNOS modules.
<code>(config)#commit</code>	Commit the candidate configuration to the running configuration
<code>(config)#exit</code>	Exit configuration

Validation

```
#show software-watchdog status
Software Watchdog timeout in seconds : 100
Process name           Watchdog status
=====
nsm                    Enabled
ripd                   Enabled
ospfd                  Enabled
isis                   Enabled
hostpd                 Enabled
ldpd                   Enabled
rsvpd                  Enabled
mribd                  Enabled
pimd                   Enabled
authd                  Enabled
mstpd                  Enabled
imi                    Disabled
onmd                   Enabled
HSL                    Enabled
oam                    Enabled
vlogd                  Enabled
vrrpd                  Enabled
ndd                    Enabled
ribd                   Enabled
bgpd                   Enabled
l2mribd                Enabled
lagd                   Enabled
sflow                  Enabled
```

Configure sFlow for Single Collector

Overview

This chapter provides the steps for configuring Sampled Flow (**sFlow**¹).

sFlow is the standard for monitoring high-speed switched and routed networks. The sFlow monitoring system consists of an sFlow Agent which is embedded in a switch or router and an sFlow Collector.

The sFlow agent samples packets as well as polling traffic statistics for the device it is monitoring. The packet sampling is performed by the switching/routing device at wire speed. The sFlow agent forwards the sampled traffic statistics in sFlow PDUs as well as sampled packets to an sFlow collector for analysis.



Note: sFlow egress sampling for multicast, broadcast, or unknown unicast packets is not supported.

The sFlow agent uses the following forms of sampling:

- Sampling packets: samples one packet out of a defined sampling rate. This sampling is done by hardware at wire speed.
- Sampling counters: polls interface statistics such as generic and Ethernet counters at a defined interval.

You must enable the sFlow feature and collector before enabling sFlow sampling on an interface.

You cannot globally enable sFlow sampling monitoring on all interfaces with a single command. Instead you must enable sFlow sampling on the required interfaces individually.

sFlow feature is supported on physical interface as well as **LAG**² interface. Configuring sampling on a LAG interface will enable the same on all member ports part of that LAG interface.

- When sflow sampling is in-progress on high rate, CPU usage spike messages from Chassis monitoring module (cmmd) is expected.

¹Sampled Flow data sFlow (sFlow) is the standard for monitoring high-speed switched and routed networks. The sFlow monitoring system consists of an sFlow Agent which is embedded in a switch or router and an sFlow Collector.

²Link Aggregation Group

Topology

Figure 47. Basic sFlow topology

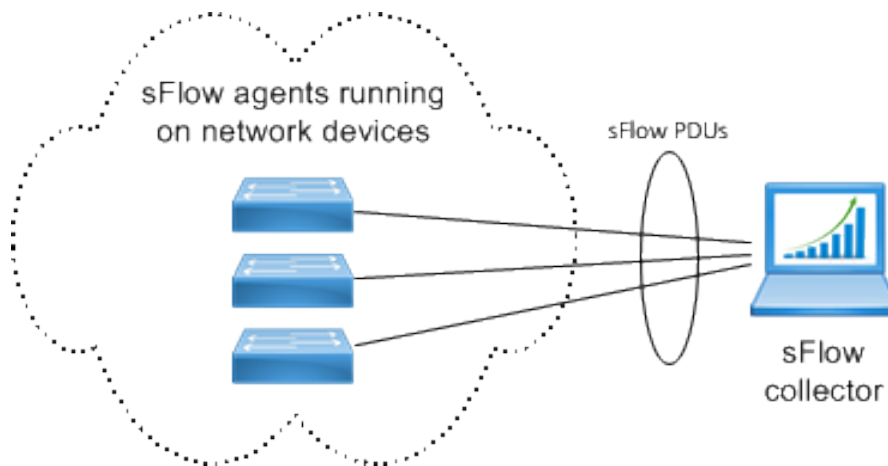

Configuration

sFlow Agent

#configure terminal	Enter configure mode.
(config)#feature sflow	Enable the sFlow feature.
(config)#sflow collector 2.2.2.2 port 6343 receiver-time-out 0 max-datagram-size 200	Configure the sFlow collector. The IP address must be reachable via the management VRF ¹ .
(config)#interface xe1	Enter interface mode
(config-if)#sflow poll-interval 5	Set the counter poll interval on the interface.
(config-if)#sflow sampling-rate 1024 direction ingress max-header-size 200	Set the sFlow sampling interval on the interface in ingress directions.
(config-if)#sflow sampling-rate 1024 direction egress max-header-size 120	Set the sFlow sampling interval on the interface in egress directions.
(config-if)#sflow enable	Start packet sampling on the interface
(config-if)#commit	Commit the candidate configuration to the running configuration
(config-if)#end	Exit interface and configure mode.

Validation

```
#show sflow detail
sFlow Feature: Enabled
sFlow Version: 5
sFlow Global Information :
```

¹Virtual Routing and Forwarding

```

Agent      IP: 10.10.26.132
Collector IP: 2.2.2.2   Port: 6343
Maximum Datagram Size(bytes): 200
Receiver timeout(sec)   : 0
    
```

sFlow Port Detailed Information:

Interface	Packet-Sampling		Packet-Sampling		Counter-Polling		Maximum Size (bytes)
	Rate		Count		Interval	Count	
(sec)	Ingress	Egress Ingress	Ingress Egress	Egress			
xe1/1 20	1024	1024	464564	414532	5	131	120

Configure sFlow for Multiple Collectors

Overview

The **sFlow**¹ feature collects sampled traffic data and counters from configured interfaces. The collected data is sent to a collector using the sFlow protocol. For more information, refer to [RFC 3176](#).

This functionality is enhanced to support multiple collectors with one connections for each, simultaneously.

Feature Characteristics

- Supports maximum of five concurrent sFlow collectors on the system.
- Uses a specific user defined **VRF**² interface for each collector. If not specified, the management VRF is used.
- Sends the collected sFlow samples on each interface to the corresponding collector configured on the interface.

Benefits

The sFlow with multiple collectors support provides the capability to do multiple analysis simultaneous in a network.

Prerequisites

Make sure to enable the required interface with sflow data collection and a agent IP address. For example,

```
!  
feature sflow  
sflow agent-ip 1.2.7.10  
!
```

¹Sampled Flow data sFlow (sFlow) is the standard for monitoring high-speed switched and routed networks. The sFlow monitoring system consists of an sFlow Agent which is embedded in a switch or router and an sFlow Collector.

²Virtual Routing and Forwarding

sFlow Configuration

This section provides the configurations required to assign multiple **sFlow**¹ collectors to OcNOS.

Topology

The following topology illustrates the sFlow multiple collectors connected with one sFlow Packet Data Unit (**PDU**)²:

Figure 48. sFlow with Multiple Collectors

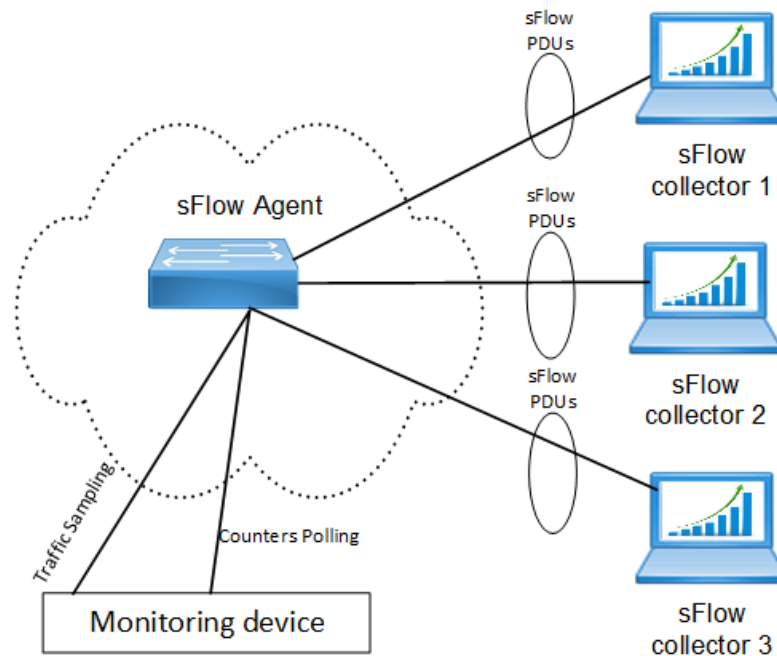

Perform the following configurations:

1. Configure sFlow using the configuration provided in [Configure sFlow for Single Collector \(page 700\)](#) section for single collector.
2. In the interface mode, enable sFlow for a particular interface and specify the collector-id for multiple collectors:

```
OcNOS(config)#interface xe12
OcNOS(config-if)#sflow sampling-rate 1024 direction ingress max-header-size 256
OcNOS(config-if)#sflow sampling-rate 2000 direction egress max-header-size 16
OcNOS(config-if)#sflow enable
OcNOS(config-if)#sflow poll-interval 10
OcNOS(config-if)#sflow collector-id 3
```

Show Running Configurations

The following show output display the sample sflow configuration details.

¹Sampled Flow data sFlow (sFlow) is the standard for monitoring high-speed switched and routed networks. The sFlow monitoring system consists of an sFlow Agent which is embedded in a switch or router and an sFlow Collector.

²A unit of data transmitted as a composite by a protocol.

```
OcNOS#show running-config sflow feature sflow
!
sflow agent-ip 1.2.7.10
sflow collector-id 3 collector 1.2.3.24 port 6345 receiver-time-out 5 max-
datagram-size 1560
sflow collector-id 4 collector 1.2.4.24 port 6346 receiver-time-out 4 max-
datagram-size 1570 vrf default
!
interface xe12
 sflow sampling-rate 1024 direction ingress max-header-size 256
sflow sampling-rate 2000 direction egress max-header-size 16 sflow enable
sflow poll-interval 10
sflow collector-id 3
!
interface xe13
 sflow sampling-rate 2500 direction ingress max-header-size 100
 sflow sampling-rate 2000 direction egress max-header-size 16
sflow enable
sflow poll-interval 5
sflow collector-id 4
!
```

Validation

The following show output displays the sFlow details:

```
OcNOS#show sflow detail
sFlow Feature: Enabled
sFlow Version: 5
Agent IP      : 1.2.7.10
Collector 3:
  IP: 1.2.3.24      Port: 6345
  VRF                :
  Maximum Datagram Size(bytes): 1560
  Receiver timeout(sec) : 0
Collector 4:
  IP: 1.2.4.24      Port: 6346
  VRF                :
  Maximum Datagram Size(bytes): 1570
  Receiver timeout(sec) : 0

sFlow Port Detailed Information:
```

Interface	Collector	Packet-Sampling		Packet-Sampling	Counter-	
		Maximum Header	Maximum Header		Interval	Ingress
ID	Rate	Ingress	Egress	(sec)	Ingress	Egress
Xe12	3	1024	2000	3	10	0
256	16					
Xe13	4	2500	2000	4	5	3
100	16					

sFlow Multiple Collector Commands

The sFlow feature introduces a new parameter `collector-id`.

For additional information about the revised [sflow collector \(page 747\)](#) command, refer to the sFlow Commands section.

sFlow Multiple Collector Commands with user defined vrfs

sFlow Multiple Collector Commands with User Defined VRFs

The sFlow feature introduces a new parameter `collector-id`.

- Users can sample packets on an interface mapped to a user-defined **VRF**¹ and send sFlow packets through the same VRF.
- Users can send sampled packets to multiple destinations (collectors) through different VRFs simultaneously.

The following sample configuration demonstrates sFlow using multiple collector-ids with user-defined VRFs:

```
feature sflow
sflow collector-id 3 collector 172.20.1.1 port 6343 receiver-time-out 0 max-datagram-size 200 vrf sys_
mgmt
sflow collector-id 4 collector 192.168.7.2 port 6343 receiver-time-out 1000 max-datagram-size 200 vrf
xell_vrf
sflow collector-id 5 collector 172.10.1.1 port 65535 receiver-time-out 0 max-datagram-size 200 vrf xe10_
10_vrf
sflow collector 192.168.7.2 port 65530 receiver-time-out 1000 max-datagram-size 200
sflow collector-id 2 collector 10.1.1.1 port 1024 receiver-time-out 345 max-datagram-size 400 vrf xe10_
vrf
!
interface xe12
sflow sampling-rate 1029 direction ingress max-header-size 120
sflow sampling-rate 1029 direction egress max-header-size 120
sflow enable
!
interface xe13
sflow sampling-rate 1048 direction ingress max-header-size 140
sflow enable
sflow collector-id 5
!
interface xe14
sflow sampling-rate 1048 direction ingress max-header-size 128
sflow sampling-rate 1048 direction egress max-header-size 128
sflow enable
sflow poll-interval 20
sflow collector-id 3
!
interface xe15
sflow sampling-rate 1029 direction ingress max-header-size 120
sflow enable
sflow collector-id 4
```

Validation

The following show output displays the sFlow details associated with multiple vrf's:

```
S9510-30XC-A#show sflow detail
sFlow Feature: Enabled
sFlow Version: 5
Agent IP : 172.16.1.2
Collector 3:
IP: 172.20.1.1 Port: 6343
```

¹Virtual Routing and Forwarding

```

VRF : sys_mgmt
Maximum Datagram Size(bytes): 200
Receiver timeout(sec) : 0
Collector 4:
IP: 192.168.7.2 Port: 6343
VRF : xel1_vrf
Maximum Datagram Size(bytes): 200
Receiver timeout(sec) : 0
Collector 5:
IP: 172.10.1.1 Port: 65535
VRF : xe10_10_vrf
Maximum Datagram Size(bytes): 200
Receiver timeout(sec) : 0
Collector 1:
IP: 192.168.7.2 Port: 65530
VRF :
Maximum Datagram Size(bytes): 200
Receiver timeout(sec) : 0
Collector 2:
IP: 10.1.1.1 Port: 1024
VRF : xe10_vrf
Maximum Datagram Size(bytes): 400
Receiver timeout(sec) : 0
sFlow Port Detailed Information:
Interface Collector Packet-Sampling Packet-Sampling Counter-Polling Maximum Header
ID Rate Count Interval Count Size(bytes)
Ingress Egress Ingress Egress (sec) Ingress Egress
-----
xe12 1 1029 1029 0 0 0 0 120 120
xe13 5 1048 0 0 0 0 0 140 0
xe14 3 1048 1048 0 0 20 1248 128 128
xe15 4 1029 0 0 0 0 0 120 0
xe16 2 2048 3020 0 0 0 0 140 128
    
```

Glossary

Key Terms/Acronym	Description
PDU	A unit of data transmitted as a composite by a protocol.
sFlow	Sampled Flow data sFlow (sFlow) is the standard for monitoring high-speed switched and routed networks. The sFlow monitoring system consists of an sFlow Agent which is embedded in a switch or router and an sFlow Collector.

Control Plane Policing Configuration

This chapter contains basic information and a sample configuration of CPU queue properties. The device has multiple CPU queues for managing and classifying control traffic and offers rate limiters for control plane protection. Various types of CPU port-bound packets are queued into different CPU queues, each with different properties such as rate, queue limit, monitoring status, and drop status.

Control plane policing (CoPP) manages the traffic flow destined to the host router CPU for control plane processing. CoPP limits the traffic forwarded to the host CPU and avoids impact on system performance.

- CoPP has organized the handling of control packets by providing per-protocol hardware CPU queues. So, control packets are queued in different CPU queues based on protocol.
- Per-protocol CPU queue rate limits and buffer allocations are programmed during router initialization, thus, every CPU queue is rate-limited to a default stable and balanced behavior across protocols.
- When control packets are received at a higher rate than the programmed rate, the excess traffic is dropped at the queue level in the packet processor hardware itself.
- All CPU queues are pre-programmed with default rate limits and buffer allocations to ensure a default stable and balanced behavior across protocols.

Topology

A network traffic simulator device connects to a router (R1) to generate and send various types of network traffic. The router, which has CoPP configured, manages and limits traffic destined for its CPU using multiple CPU queues with specific properties for different control traffic types. Another traffic simulator device connects to the router to generate or receive traffic, testing the router's CPU queues and CoPP configurations to handle different traffic loads and types.



Figure 49. Simple configuration of CPU Queuing

The CPU queue rates are listed for each protocol queue.

Table 47. Default CPU queues

Protocol Queues	Default Rate in packets per second (PPS)	Maximum configurable rate in (PPS)	Description
Best-effort	2113	2113	L3 Known Unicast packet matching the local route (not matching any other rule) .
IPMC-miss	2113	2113	IP Multicast Route-DST-Lookup miss packets.
L3-miss	211	211	IP L3 Route-DST-Lookup miss packets.
SFLOW	32000	100000	SFLOW Sampled Packets

Table 47. Default CPU queues (continued)

Protocol Queues	Default Rate in packets per second (PPS)	Maximum configurable rate in (PPS)	Description
BGP	1500	1500	BGP packets with TCP port 179(both Server and Client)
VRRP	1024	1024	VRRP ipv4/ipv6 packets: IP protocol number 112
LDP-RSVP	500	500	RSVP and LDP packets RSVP: IP protocol 46 LDP: L4 source/destination port number:646
RIP	500	500	RIP/RIPv1/RIPNG packets : UDP ¹ DST port 520/521
OSPF	2000	2000	OSPF packets (IP protocol 89)
DHCP ²	100	2048	DHCP: DHCP ipv4/ipv6 server/client packets UDP source/destination port number:ipv4(67/68) ipv6 (546/547)
ND	6000	6000	ICMPv6 packets: IP next header number 58
PIM	4000	4000	Protocol Independent Multicast packets: IP protocol number 103 and DMAC: 01:00:5e:00:00:0D
ARP	6000	6000	ARP packets: Ether-type 0x0806
IGMP	4000	4000	Internet Group Management Protocol (IP protocol 2)
BPDU	10000	10000	xSTP : DMAC 0180:C200:0000 Provider Bridging : DMAC 0180:C200:0008 LACP : DMAC 0180:C200:0002, ethertype:0x8809, subtype:1/2 DOT1X/AUTHD : DMAC 0180:C200:0003 LLDP : DMAC 0180:C200:000E EFM : DMAC 0180:C200:0002, ethertype:0x8809, subtype:3 ELMI : DMAC 0180:C200:0007 LBD : DMAC 010f:E200:0007, ethertype:0x8918 MCEC IDP : UDP source/destination port 1025 MLAG PDU ³ : DMAC 0180:C200:0000
CCM	1000	1000	UDLD mode : DMAC: 0100.0CCC.CCCC CFM packets : Ether type : 0x8902, DMAC : 0108.c200.0030 G8032 packets : DMAC 0119:A700:00XX
BFD	2000	2000	Software-BFD Single hop packets: UDP port 3784, TTL 255

¹User Datagram Protocol²Dynamic Host Configuration Protocol³A unit of data transmitted as a composite by a protocol.

Table 47. Default CPU queues (continued)

Protocol Queues	Default Rate in packets per second (PPS)	Maximum configurable rate in (PPS)	Description
			Software-BFD Multi hop packets: UDP port 4784
IS-IS	500	1000	ISIS (DMAC 0180:C200:0014/0015) ESIS (DMAC 0900:2B00:0004/0005) <div style="border: 1px solid black; padding: 5px; margin-top: 10px;">  Note: ESIS = End System-to-Intermediate System (ISIS point-to-point case) </div>
ACL	200	200	ACL based logging packets
VXLAN	500	500	ARP,RARP and ND cache queue for packets coming on VXLAN access ports
DAIVM	100	500	Guest VM packets

Validate the default CPU queue rates by using the command [show cpu-queue details \(page 783\)](#).

```

R1#show cpu-queue details
* - Can not configure the parameter
Cpu queue
Status
Name           Configured  Default    Lossy Status  Max Rate Allowed  Configured  Default    Configured  Default  Monitor
=====
=====
best-effort    -           2113       2113          -              -             * no-monitor -         *
lossy
ipmc-miss     -           2113       2113          -              -             * no-monitor -         *
lossy
l3-miss       -           211        211           -              -             * no-monitor -         *
lossy
sflow         -           32000     100000        -              -             monitor    -         *
lossy
bgp           -           1500      1500          -              -             monitor    -
lossless
vrrp          -           1024      1024          -              -             monitor    -
lossless
rip           -           500       500           -              -             monitor    -
lossless
ospf          -           2000     2000          -              -             monitor    -
lossless
dhcp          -           100       2048          -              -             no-monitor -
lossy
nd            -           6000     6000          -              -             monitor    -
lossless
pim           -           4000     4000          -              -             * no-monitor -         *
lossy
arp           -           6000     6000          -              -             monitor    -
lossless
igmp          -           4000     4000          -              -             * no-monitor -         *
lossy
bpdu          -           10000    10000         -              -             monitor    -
lossless
ccm           -           1000     1000          -              -             no-monitor -
lossy
bfd           -           2000     2000          -              -             no-monitor -
lossy
ptp           -           1000     1000          -              -             no-monitor -
lossy
    
```

```

isis          -          500      1000      -          monitor      -
  lossless
trill-isis    -          1000     1000     -          monitor      -
  lossless
acl           -          200      1000     -          * no-monitor  -      *
lossy
vxlan        -          500      500      -          monitor      -
  lossy
daivm        -          100      500      -          no-monitor   -
  lossy
    
```

- Enable the feature before validating the CPU queue for each protocol.
- The monitor option starts generating operational logs for the number of dropped packets and the percentage.

```

OcNOS(config)#2021 Nov 16 11:40:24.188 : OcNOS : HSL : CRITI : [CPU_QUEUE_IS_FULL_2]: 967368133
packets dropped at queue bpdu due to queue full. Average CPU queue rate is 99% (499 pkts/sec).
    
```

Configuring CPU Queuing Lossless

When lossless is configured on a CPU queue, control traffic to that queue is treated as lossless. The traffic is not dropped on the CPU queue; instead, it creates backpressure on the ingress port. If the ingress port runs out of buffering resources, the control traffic is dropped. This can also cause other traffic on the same port to be dropped, which will be seen as IBP discards on the incoming port. Lossless mode provides better fairness in serving control traffic from different data ports. In lossy mode, control traffic will be tail-dropped from any port.

```

R1#configure terminal
R1(config)#cpu-queue bpdu rate 600 lossless no monitor
R1(config)#exit
    
```

Validation

Confirm the configurations with the following commands:

```

R1#show running-config | in cpu
cpu-queue bpdu rate 600 lossless no-monitor
R2#show cpu-queue details
* - Can not configure the parameter
    
```

Cpu queue Name	Rate In PPS			Monitor Status		Lossy Status	
	Configured	Default	Max Rate Allowed	Configured	Default	Configured	Default
best-effort	-	2113	2113	-	* no-monitor	-	* lossy
ipmc-miss	-	2113	2113	-	* no-monitor	-	* lossy
l3-miss	-	211	211	-	* no-monitor	-	* lossy
sflow	-	32000	100000	-	monitor	-	* lossy
bgp	-	1500	1500	-	monitor	-	lossless
vrrp	-	1024	1024	-	monitor	-	
lossless							
rip	-	500	500	-	monitor	-	lossless
ospf	-	2000	2000	-	monitor	-	lossless
dhcp	-	100	2048	-	no-monitor	-	lossy
nd	-	6000	6000	-	monitor	-	lossless
pim	-	4000	4000	-	* no-monitor	-	lossy
arp	-	6000	6000	-	monitor	-	lossless
igmp	-	4000	4000	-	* no-monitor	-	* lossy
bpdu	600	10000	10000	no-monitor	monitor	lossless	lossless
ccm	-	1000	1000	-	no-monitor	-	lossy
bfd	-	2000	2000	-	no-monitor	-	lossy
ptp	-	1000	1000	-	no-monitor	-	lossy
isis	-	500	1000	-	monitor	-	lossless
trill-isis	-	1000	1000	-	monitor	-	lossless

```

acl          -          200    1000          -          * no-monitor      -          * lossy
vxlan        -          500    500          -          monitor           -          lossy
daivm        -          100    500          -          no-monitor        -          lossy
R1#show interface cpu counters rate kbps
Load interval: 30 second
+-----+-----+-----+-----+-----+
| CPU Queue(%) | Rx kbps | Rx pps | Tx kbps | Tx pps |
+-----+-----+-----+-----+-----+
  bpdu      ( 99%) -          -          38.41    599
R1#show interface cpu counters queue-stats
E - Egress, I - Ingress, Q-Size is in bytes
* indicates monitor is active
+-----+-----+-----+-----+-----+
| Interface | Queue/Class-map | Q-Size | Tx pkts | Tx bytes | Dropped
pkts | Dropped bytes |
+-----+-----+-----+-----+-----+
  cpu      bpdu      (E)
320736  21703      1388992      5363326      343240064
    
```

Configuring CPU Queuing Lossy

When the lossy mode is configured on a CPU queue, control traffic from different ports is dropped at the CPU queue itself. This prevents backpressure on the incoming port and avoids IBP discards of data traffic. However, this mode loses fairness, as control traffic from different ports can be tail-dropped. In other words, higher amounts of control traffic from a single port can impact control plane sessions on another port.

```

R1#configure terminal
R1(config)#cpu-queue bpdu rate 500 lossy no monitor
R1(config)#exit
    
```

Validation

Confirm the configurations with the following commands:

```

R1#show running-config | in cpu
cpu-queue bpdu rate 500 lossy no-monitor
R1#show cpu-queue details
* - Can not configure the parameter
Cpu queue          Rate In PPS          Monitor Status          Lossy Status
Name              Configured           Default               Max Rate Allowed       Configured             Default               Configured             Default
=====
best-effort       -                   2113                 2113                   -                      * no-monitor          -                      * lossy
ipmc-miss         -                   2113                 2113                   -                      * no-monitor          -                      * lossy
l3-miss           -                   211                 211                    -                      * no-monitor          -                      * lossy
sflow             -                   32000                100000                 -                      monitor               -                      * lossy
bgp               -                   1500                 1500                   -                      monitor               -
  lossless
vrrp              -                   1024                 1024                   -                      monitor               -
  lossless
rip               -                   500                  500                    -                      monitor               -
  lossless
ospf              -                   2000                 2000                   -                      monitor               -
  lossless
dhcp              -                   100                  2048                   -                      no-monitor            -                      lossy
nd                -                   6000                 6000                   -                      monitor               -
  lossless
pim               -                   4000                 4000                   -                      * no-monitor          -                      * lossy
arp               -                   6000                 6000                   -                      monitor               -
  lossless
igmp              -                   4000                 4000                   -                      * no-monitor          -                      * lossy
bpdu              500                 10000                10000                   no-
    
```

```

monitor      monitor      lossy      lossless
ccm          -          1000      1000      -          no-monitor -          lossy
bfd          -          2000      2000      -          no-monitor -          lossy
ptp          -          1000      1000      -          no-monitor -          lossy
isis        -          500       1000      -          monitor   -
            lossless
trill-isis  -          1000      1000      -          monitor   -
            lossless
acl          -          200       1000      -          * no-monitor -          * lossy
vxlan       -          500       500       -          monitor   -          lossy
daivm       -          100       500       -          no-monitor -          lossy
    
```

```

R1#show interface cpu counters queue-stats
E - Egress, I - Ingress, Q-Size is in bytes
* indicates monitor is active
    
```

```

+-----+-----+-----+-----+-----+-----+
+-----+
| Interface | Queue/Class-map | Q-Size | Tx pkts | Tx bytes | Dropped
pkts | Dropped bytes |
+-----+-----+-----+-----+-----+-----+
+-----+
cpu      nd      (E)
0        17      1998      0        0
cpu      bpdu    (E)
86320   153802  9843328  39667426 2538702464
    
```

```

R1#show interface cpu counters rate kbps
Load interval: 30 second
    
```

```

+-----+-----+-----+-----+-----+-----+
| CPU Queue(%) | Rx kbps | Rx pps | Tx kbps | Tx pps |
+-----+-----+-----+-----+-----+
bpdu          ( 99%) -          -          31.97      499
    
```

MONITOR AND REPORTING SERVER COMMAND REFERENCE

Software Monitoring and Reporting	716
clear cores	717
copy core	718
copy techsupport	720
feature software-watchdog	722
remove file (techsupport)	723
show bootup-parameters	724
show cores	725
show running-config watchdog	726
show software-watchdog status	727
show system log	729
show system login	730
show system reboot-history	731
show system resources	732
show system uptime	734
show techsupport	735
show techsupport status	738
software-watchdog	739
software-watchdog keep-alive-time	741
sFlow Commands	742
clear sflow statistics	743
debug sflow	744
feature sflow	745
sflow agent-ip	746
sflow collector	747
sflow enable	749
sflow poll-interval	750
sflow rate-limit	751
sflow sampling-rate	752
show sflow	754
show sflow interface	756
show sflow global	757
show sflow statistics	758
Control Plane Policing Commands	759
class-map type	760

class type copp	761
clear interface cpu counters	762
copp service-policy	763
cpu-queue	764
match access-group	767
ip copp access-list	768
ip copp access-list icmp	770
ip copp access-list tcp udp	774
police	780
policy-map	781
show interface cpu counters queue-stats	782
show cpu-queue details	783
Object Tracking Commands	785
track ip sla reachability	786
delay up down	787
object tracking	788
show track	790
show track summary	791
show running-config track	792
IP Service Level Agreements Commands	793
clear ip sla statistics	794
frequency	795
icmp-echo	796
ip sla	797
ip sla schedule	798
show ip sla statistics	799
show ip sla summary	801
show running-config ip sla	802
threshold	803
timeout	804

Software Monitoring and Reporting

This document describes software watchdog and reporting related commands.

clear cores	717
copy core	718
copy techsupport	720
feature software-watchdog	722
remove file (techsupport)	723
show bootup-parameters	724
show cores	725
show running-config watchdog	726
show software-watchdog status	727
show system log	729
show system login	730
show system reboot-history	731
show system resources	732
show system uptime	734
show techsupport	735
show techsupport status	738
software-watchdog	739
software-watchdog keep-alive-time	741

clear cores

Use this clear command to delete the core files present in `/var/log/crash/cores`.

Command Syntax

```
clear cores (|WORD)
```

Parameters

WORD

Core file name

Default

None

Command Mode

Execution mode

Applicability

This command was introduced before OcNOS version 1.3.

Example

```
#show cores
Core location :/var/log/crash/cores
Core-File-Name
-----
core_hostpd.9581_20190324_222313_signal_11.gz

#clear cores core_hostpd.9581_20190324_222313_signal_11.gz

#show cores
Core location :/var/log/crash/cores
Core-File-Name
-----
```

copy core

Use this command to copy the core file to another file.

The core filename is in the form: core_PROCESSNAME.PROCID_YYMMDD_HHMMSS_signal_SIGNUM.gz

Command Syntax

```
copy core FILE (tftp TFTP-URL|ftp FTP-URL|scp SCP-URL|sftp SFTP-URL) (vrf (NAME|management)|)
```

Parameters

core

Copy Crash core files to remote location. Core file location: `/var/log/crash/cores/`

FILE

Source file name

TFTP-URL

Destination: `tftp: [//server[:port]] [/path]`

FTP-URL

Destination: `ftp: [//server] [/path]`

SCP-URL

Destination: `scp: [//server] [/path]`

SFTP-URL

Destination: `sftp: [//server] [/path]`

NAME

Virtual Routing and Forwarding name

management

Management Virtual Routing and Forwarding

Default

None

Command Mode

Execution mode

Applicability

This command was introduced before OcNOS version 1.3.

Example

```
# copy core core_hostpd.9581_20190324_222313_signal_11.gz scp scp://10.12.16.17/home/ core core_
hostpd.9581_20190324_222313_signal_11.gz vrf management
Enter Username:root
Enter Password:
  % Total      % Received % Xferd  Average Speed   Time    Time       Time  Current
                                 Dload  Upload  Total   Spent    Left     Speed
 100 681k    0     0    0 681k      0 3588k  --:--:--  --:--:--  --:--:-- 3588k
 100 681k    0     0    0 681k      0 3588k  --:--:--  --:--:--  --:--:-- 3588k
```

Copy Success

copy techsupport

Use this command to copy the contents of a compressed techsupport file (`tar.gz`) to another file.

The default filename is in the form: `tech_support_YYYY_MMM_DD_HH_MM_SS.tar.gz`.

Command Syntax

```
copy (log|techsupport) FILE (tftp TFTP-URL|ftp FTP-URL|scp SCP-URL|sftp SFTP-URL) (vrf
(NAME|management) |)
```

Parameters

log

Log file storage; on Linux this refers to `/var/log/`

techsupport

Tech support file storage; on Linux this refers to `/var/log/`

FILE

Source file name

TFTP-URL

Destination: `tftp: [//server[:port]] [/path]`

FTP-URL

Destination: `ftp: [//server] [/path]`

SCP-URL

Destination: `scp: [//server] [/path]`

SFTP-URL

Destination: `sftp: [//server] [/path]`

NAME

Virtual Routing and Forwarding name

management

Management Virtual Routing and Forwarding

Default

None

Command Mode

Privileged execution mode

Applicability

This command was introduced before OcNOS version 1.3.

Example

```
#copy techsupport tech_support_23_Feb_2019_18_27_00.tar.gz scp scp://10.12.16.17/home/tech_support_
23_Feb_2019_18_27_00.tar.gz vrf management
```

```
Enter Username:root
```

```
Enter Password:
% Total % Received % Xferd Average Speed Time Time Time Current
Dload Upload Total Spent Left Speed
100 72368 0 0 0 72368 0 147k --:- --:- --:- 147k
100 72368 0 0 0 72368 0 147k --:- --:- --:- 147k
Copy Success
#
```

feature software-watchdog

Use this command to enable software watchdog functionality for all OcNOS modules. This feature is enabled by default.

Use the **no** form of this command to disable software watchdog functionality.

Command Syntax

```
feature software-watchdog
no feature software-watchdog
```

Parameters

None

Default

By default, software watchdog is enabled.

Command Mode

Configure mode

Applicability

This command was introduced before OcNOS version 1.3.

Examples

```
#configure terminal
#(config)feature software-watchdog
```

remove file (techsupport)

Use this command to remove techsupport files from `/var/log` directory.

Command Syntax

```
remove file (techsupport) (all|FILENAME|)
```

Parameter

techsupport

Tech support option for protocol(s).

all

Remove all files.

FILENAME

Name of the file to be deleted.

Default

None

Command Mode

Execution mode

Applicability

This command was introduced before OcNOS version 6.4.

Examples

```
OcNOS#remove file techsupport /var/log/ OcNOS_tech_support_all_14_Feb_2019_15_39_34.tar.gz
```

```
OcNOS#remove file techsupport all
```

show bootup-parameters

Use this command to show OcNOS kernel bootup parameters.

Command Syntax

```
show bootup-parameters
```

Parameters

None

Command Mode

Execution mode

Applicability

This command was introduced before OcNOS version 1.3.

Examples

```
#show bootup-parameters  
BOOT_IMAGE=/boot/vmlinuz-3.16.7-g490411a-ec-as7712-32x root=UUID=317567fc-b69e-45d9-ab4e-fa1d9e57b703  
console=ttyS1,115200n8 ro
```

show cores

Use this command to list core files in the system or to display information about a given core file.



Note: When cmlsh logged in via non-root user crashes, core files will not get generated. User can further debug the issue based on CLI-history and logs from /var/log/messages.

Command Syntax

```
show cores ([WORD details])
```

Parameters

WORD

Core file name

Command Mode

Execution mode

Applicability

This command was introduced before OcNOS version 1.3.

Examples

```
#show cores
Core location :/var/log/crash/cores
Core-File-Name
-----
core_nsm.683_20191110_103611_signal_5.gz
core_nsm.712_20191107_171803_signal_11.gz
core_nsm.684_20191112_054937_signal_5.gz
core_yangcli.5695_20191107_171715_signal_11.gz
```

Here is the explanation of the show command output fields.

Table 48. show cores fields

Entry	Description
Core-File-Name	Core dump file name.

show running-config watchdog

Use this command to display watchdog configurations.

Command Syntax

```
show running-config watchdog
```

Parameters

None

Command Mode

Privileged EXEC

Applicability

This command was introduced in OcNOS version 5.0

Examples

```
#show running-config watchdog  
software-watchdog keep-alive-time 300
```

show software-watchdog status

Use this command to display the software watchdog status for each OcNOS module.

Command Syntax

```
show software-watchdog status
show software-watchdog status detail
```

Parameters

None

Command Mode

Execution mode

Applicability

This command was introduced before OcNOS version 1.3 and updated in OcNOS version 1.3.4.

Examples

```
#show software-watchdog status
Software Watchdog timeout in seconds : 60
Process name           Watchdog status
=====
nsm                     Enabled
ripd                    Enabled
ripngd                  Enabled
ospfd                   Enabled
ospf6d                  Enabled
isisd                   Enabled
hostpd                  Enabled
ldpd                    Enabled
rsvpd                   Enabled
mribd                   Enabled
pimd                    Enabled
authd                   Enabled
mstpd                   Enabled
imi                     Enabled
onmd                    Enabled
HSL                     Enabled
oamd                    Enabled
vlogd                   Enabled
vrrpd                   Enabled
ndd                     Enabled
ribd                    Enabled
bgpd                    Enabled
l2mribd                 Enabled
lagd                    Enabled
sflow                   Enabled
udld                    Enabled
cmld                    Enabled
cmmd                    Enabled
pcepd                   Enabled
```

```
#show software-watchdog status detail
Software Watchdog timeout in seconds : 60
```

```

Process Watchdog Process Disconnect Connect Last Restart
Name Status Status Count Count Reason
=====
nsm Enabled Running 0 1 Fresh bootup
ripd Enabled Running 0 1 Fresh bootup
ripngd Enabled Running 0 1 Fresh bootup
ospfd Enabled Running 0 1 Fresh bootup
ospf6d Enabled Running 0 1 Fresh bootup
isisd Enabled Running 0 1 Fresh bootup
hostpd Enabled Running 3 4 Segmentation fault
ldpd Enabled Running 0 1 Fresh bootup
rsvpd Enabled Running 0 1 Fresh bootup
mribd Enabled Running 0 1 Fresh bootup
pimd Enabled Running 0 1 Fresh bootup
authd Enabled Running 0 1 Fresh bootup
mstpd Enabled Running 0 1 Fresh bootup
imi Enabled Running 0 1 Fresh bootup
onmd Enabled Running 0 1 Fresh bootup
HSL Enabled Running 0 1 Fresh bootup
oamd Enabled Running 0 1 Fresh bootup
vlogd Enabled Running 0 1 Fresh bootup
vrrpd Enabled Running 0 1 Fresh bootup
nnd Enabled Running 0 1 Fresh bootup
ribd Enabled Running 0 1 Fresh bootup
bgpd Enabled Running 0 1 Fresh bootup
l2mribd Enabled Running 0 1 Fresh bootup
lagd Enabled Running 0 1 Fresh bootup
sflow Enabled Running 0 1 Fresh bootup
udld Enabled Running 0 1 Fresh bootup
cmld Enabled Running 0 1 Fresh bootup
cmmmd Enabled Running 0 1 Fresh bootup
pcepd Enabled Running 0 1 Fresh bootup
    
```

Here is the explanation of the show command output fields.

Table 49. show software-watchdog status output fields

Field	Description
Process Name	The name of a protocol module.
Watchdog Status	Status of a protocol module (Enabled or Disabled).
Process Status	Status of the protocol module Running/Not-running).
Disconnect Count	Number of times the protocol module disconnected from monitoring module.
Connect Count	Number of times the protocol module connected to monitoring module.
Last Restart Reason	Reason why a module disconnected from monitoring module.

show system log

Use this command to display the system's log file.

Command Syntax

```
show system log
```

Parameters

None

Command Mode

Execution mode

Applicability

This command was introduced before OcNOS version 1.3.

Example

```
#show system log
Syslog           : enabled           File Name       : /var/log/messages
Oct 18 18:10:18 localhost rsyslogd: [origin software="rsyslogd" swVersion="8.4.2
" x-pid="541" x-info="http://www.rsyslog.com"] start
Oct 18 18:10:18 localhost systemd[1]: Started Apply Kernel Variables.
Oct 18 18:10:18 localhost systemd[1]: Started Create Static Device Nodes in /dev
.
Oct 18 18:10:18 localhost systemd[1]: Starting udev Kernel Device Manager...
Oct 18 18:10:18 localhost systemd[1]: Started udev Kernel Device Manager.
Oct 18 18:10:18 localhost systemd[1]: Starting Copy rules generated while the ro
ot was ro...
Oct 18 18:10:18 localhost systemd[1]: Starting LSB: Set preliminary keymap...
Oct 18 18:10:18 localhost systemd[1]: Started Copy rules generated while the roo
t was ro.
Oct 18 18:10:18 localhost nfs-common[163]: Starting NFS common utilities:.
Oct 18 18:10:18 localhost systemd[1]: Found device /dev/ttyS0.
Oct 18 18:10:18 localhost systemd[1]: Found device 16GB_SATA_Flash_Drive -CONFIG.
Oct 18 18:10:18 localhost systemd[1]: Starting File System Check on /dev/disk/by
-label/-CONFIG...
Oct 18 18:10:18 localhost systemd[1]: Starting system-ifup.slice.
Oct 18 18:10:18 localhost systemd-fsck[217]: -CONFIG: clean, 85/128016 file
s, 27057/512000 blocks
Oct 18 18:10:18 localhost systemd[1]: Created slice system-ifup.slice.
--More--
```

Here is the explanation of the show command output fields.

Table 50. show system log fields

Entry	Description
Syslog	Status of the protocol (enabled or disabled).
File Name	Specifies the name of the system log files that you configured.

show system login

Use this command to display the system's login history.

Command Syntax

```
show system login
```

Parameters

None

Command Mode

Execution mode

Applicability

This command was introduced before OcNOS version 1.3.

Example

```
#show system login
eric      ttyS0      Wed Oct 19 18:31   still logged in
takayuki  ttyS0      Wed Oct 19 18:14 - 18:25   (00:10)
girish    ttyS0      Wed Oct 19 16:46 - 17:01   (00:14)

wtmp begins Wed Oct 19 16:46:18 2016
```

show system reboot-history

Use this command to show the device reboot history.

Command Syntax

```
show system reboot-history
```

Parameters

None

Command Mode

Execution mode

Applicability

This command was introduced before OcNOS version 1.3

Examples

```
#show system reboot-history
DATE-TIME          REBOOT-REASON
-----
Thu Oct 07 12:46:56 2021  Sys-update from NOS shell
Wed Oct 13 09:35:06 2021  Reload from NOS shell
Sat Feb 16 23:19:38 2019  Reload from NOS shell
```

show system resources

Use this command to display the system's current resources.

Command Syntax

```
show system resources (iteration <1-5>|)
```

Parameters

<1-5>

The number of times to check the resources before they are displayed.

Command Mode

Execution mode

Applicability

This command was introduced before OcNOS version 1.3.

Examples

```
OcNOS#show system resources
load average: 0.12, 0.22, 0.20
Tasks: 173 total, 1 running, 172 sleeping, 0 stopped, 0 zombie
%Cpu(s): 3.1 us, 1.6 sy, 0.0 ni, 95.3 id, 0.0 wa, 0.0 hi, 0.0 si, 0.0 st
MiB Mem : 15930.2 total, 14277.8 free, 1003.0 used, 649.4 buff/cache
          0 used, 0 free. 252416 cached Mem
```

Here is the explanation of the show command output fields.

Table 51. show system resource fields

Entry	Description
Load Average	Number of processes that are running. The average reflects the system load the past 1, 5, and 15 minutes.
Tasks	Number of processes in the system and how many processes are actually running when the command is issued.
CPU	Displays the CPU utilization information for processes on the device.
KiB Mem	The memory field (Mem) shows the virtual memory used by processes. The value in the memory field is in KB and MB, and is broken down as follows: Total: The total amount of available virtual memory, in kibibytes (KiBs). Used: The total amount of used virtual memory, in kibibytes (KiBs). Free: The total amount of free virtual memory, in kibibytes (KiBs) Buffers: The size of the memory buffer used to hold data recently called from disk.

Table 51. show system resource fields (continued)

Entry	Description
KiB Swap	<p>The Swap field shows the total swap space available and how much is unused and is broken down as follows:</p> <p>Total: The total amount of available swap memory, in kibibytes (KiBs).</p> <p>Used: The total amount of used swap memory, in kibibytes (KiBs).</p> <p>Free: The total amount of free swap memory, in kibibytes (KiBs).</p> <p>Cache Memory: Memory that is not associated with any program and does not need to be swapped before being reused.</p>

show system uptime

Use this command to display how long the system has been up and running.

Command Syntax

```
show system uptime
```

Parameters

None

Command Mode

Execution mode

Applicability

This command was introduced before OcNOS version 1.3.

Examples

```
OcNOS#show system uptime
19:10:22 up 1 day, 1:01, 1 user, load average: 0.08, 0.05, 0.05
```

Here is the explanation of the show command output fields.

Table 52. show system uptime fields

Entry	Description
Time and up	Current time, in the local time zone, and how long the router or switch has been operational.
Users	Number of users logged in to the router or switch.
Load Average	Number of processes that are running. The average reflects the system load the past 1, 5, and 15 minutes.

show techsupport

Use this command to collect system data for technical support and save the support information in a compressed tar (.gz) file.

- By default, the `show techsupport` uses the file path `/var/log/` and names the file as `OcNOS_tech_support_protocolname_DD MMM YYYY HH MM SS.tar.gz`.
- If this filename already exists, a date and timestamp are appended to differentiate it from previous files.
- When a `show techsupport` command is already running, any subsequent `show techsupport` commands issued are ignored until the current command completes.
- If a `show techsupport` command is in progress and a `show running-config` command is issued, the displayed information is derived from the ongoing `show techsupport` command.
- The `techsupport` command only provides a route summary, not complete information for all routes.

Command Syntax

```
show techsupport
({all|authd|bgp|cmmd|hostpd|hsl|imi|isis|l2mribd|lag|mribd|mstp|nd|nsm|oam|onm|ospf|ospf6|pim|rib|rip|ripng|sflow|vrrp|netconf|gnmi})
```

Parameters

all

Specifies the collection of all types of information.

authd

Specifies the collection of authentication-related information.

bgp

Specifies the collection of BGP-related information.

cmmd

Specifies the collection of chassis management related information.

hostpd

Specifies the collection of system management related information.

hsl

Specifies the collection of HSL-related information.

imi

Specifies the collection of IMM-related information.

isis

Specifies the collection of ISIS-related information.

l2mribd

Specifies the collection of Layer 2 Multicast RIB-related information.

lag

Specifies the collection of **LAG**¹ or LACP-related information.

mribd

Specifies the collection of Multicast RIB-related information.

¹Link Aggregation Group

mstp

Specifies the collection of MSTP-related information.

nd

Specifies the collection of Neighbor Discovery related information.

nsm

Specifies the collection of NSM-related information.

oam

Specifies the collection of BFD-related information.

onm

Specifies the collection of ONM or LLDP-related information.

ospf

Specifies the collection of OSPF-related information.

ospf6

Specifies the collection of OSPF6-related information.

pim

Specifies the collection of PIM-related information.

rib

Specifies the collection of RIB-related information.

rip

Specifies the collection of RIP-related information.

ripng

Specifies the collection of RIPNG-related information.

sflow

Specifies the collection of **sFlow**¹-related information.

vrrp

Specifies the collection of VRRP-related information.

netconf

Specifies the collection of NetConf and Callhome related information.

gnmi

Specifies the collection of gNMI-related information.

Default

None

Command Mode

Privileged execution mode

Applicability

Introduced before OcNOS version 1.3. Introduced the **netconf** and **gnmi** parameters in the OcNOS version 6.5.1.

¹Sampled Flow data sFlow (sFlow) is the standard for monitoring high-speed switched and routed networks. The sFlow monitoring system consists of an sFlow Agent which is embedded in a switch or router and an sFlow Collector.

Example

The following command demonstrates how to use `show techsupport` to collect various types of system information.

```
#show techsupport all
#show techsupport bgp
#show techsupport isis
#show techsupport gnmi
#show techsupport netconf
```

show techsupport status

Use this cli to view the status of `show techsupport` CLI to generate techsupport archive.

Command Syntax

```
show techsupport status
```

Parameters

None

Command Mode

Privileged execution mode

Applicability

This command was introduced before OcNOS version 4.2.

Example

```
#show techsupport status
Tech Support Command Execution Is Complete
##Generated Tech Support File-list
/var/log/OcNOS_tech_support_18_Jun_2021_10_01_38.tar.gz
Tar File is generated at /var/log and file name begins with 'OcNOS_tech_support'
```

software-watchdog

Use this command to enable the software watchdog feature for an OcNOS module.

Use the `no` form of this command to disable the software watchdog feature.

Command Syntax

```
software-watchdog (nsm|authd|bgpd|cml|hostpd|imi|isisd|lagd|l2mribd|
mstpd|mribd|nnd|oamd|onmd|ospfd|ospf6d|pimd|ribd|ripd|ripngd|sflow|vlogd|vrrpd|hsl|cmmd)

no software-watchdog (nsm|authd|bgpd|cml|hostpd|imi|isisd|lagd|l2mribd|
mstpd|mribd|nnd|oamd|onmd|ospfd|ospf6d|pimd|ribd|ripd|ripngd|sflow|vlogd|vrrpd|hsl|cmmd)
```

Parameters

authd

Software watchdog for AUTH module

bgpd

Software watchdog for BGP module

cml

Software watchdog for CML module

cmmd

Software watchdog for CMM module

hostpd

Software watchdog for HOSTP module

hsl

Software watchdog for HSL module

imi

Software watchdog for IMI module

isisd

Software watchdog for ISIS module

l2mribd

Software watchdog for L2MRIB module

lagd

Software watchdog for **LAG**¹ module

mribd

Software watchdog for MRIB module

mstpd

Software watchdog for MSTP module

nnd

Software watchdog for NDD module

nsm

Software watchdog for NSM module

oamd

Software watchdog for OAM module

¹Link Aggregation Group

onmd

Software watchdog for ONM module

ospf6d

Software watchdog for OSPF6 module

ospfd

Software watchdog for OSPF module

pimd

Software watchdog for PIM module

ribd

Software watchdog for RIB module

ripd

Software watchdog for RIP module

ripngd

Software watchdog for RIPNG module

sflow

Software watchdog for SFLOW module

vlogd

Software watchdog for VLOG module

vrripd

Software watchdog for VRRP module

Default

By default, software watchdog is enabled.

Command Mode

Configure mode

Applicability

This command was introduced before OcNOS version 1.3.

Examples

```
#configure terminal
(config)#no software-watchdog imi
(config)#software-watchdog nsm
```

software-watchdog keep-alive-time

Use this command to set the software watchdog keep-alive time interval in seconds.

Use the `no` form of this command to set default keep-alive time interval.

Command Syntax

```
software-watchdog keep-alive-time <30-1800>  
no software-watchdog keep-alive-time
```

Parameters

<30-1800>

Keep-alive time interval in seconds

Default

By default, software watchdog is enabled and the keep-alive time interval is 60 seconds.

Command Mode

Configure mode

Applicability

This command was introduced before OcNOS version 1.3.

Examples

```
#configure terminal  
(config)#software-watchdog keep-alive-time 100
```

sFlow Commands

This chapter describes the Sampled Flow (**sFlow**¹) commands.

clear sflow statistics	743
debug sflow	744
feature sflow	745
sflow agent-ip	746
sflow collector	747
sflow enable	749
sflow poll-interval	750
sflow rate-limit	751
sflow sampling-rate	752
show sflow	754
show sflow interface	756
show sflow global	757
show sflow statistics	758

¹Sampled Flow data sFlow (sFlow) is the standard for monitoring high-speed switched and routed networks. The sFlow monitoring system consists of an sFlow Agent which is embedded in a switch or router and an sFlow Collector.

clear sflow statistics

Use this command to clear **sFlow**¹ sampling-related counters such as the number of packets sampled and the number of counters sampled.

Command Syntax

```
clear sflow statistics (interface IFNAME|)
```

Parameter

IFNAME

Interface name

Default

None

Command Mode

Execution mode

Applicability

This command was introduced before OcNOS version 1.3.

Example

```
#clear sflow statistics
```

¹Sampled Flow data sFlow (sFlow) is the standard for monitoring high-speed switched and routed networks. The sFlow monitoring system consists of an sFlow Agent which is embedded in a switch or router and an sFlow Collector.

debug sflow

Use this command to display **sFlow**¹ debugging messages.

Command Syntax

```
debug sflow (all|agent|sampling|polling|)
```

Parameters

all

Debug all (agent,sampling,polling)

agent

Debug sFlow agent

sampling

Debug sFlow sampling

polling

Debug sFlow polling

Default

Disabled.

Command Mode

Execution mode and Configure mode

Applicability

This command was introduced before OcNOS version 1.3.

Example

```
#debug sflow all
#debug sflow agent
#configure terminal
(config)#debug sflow agent
```

¹Sampled Flow data sFlow (sFlow) is the standard for monitoring high-speed switched and routed networks. The sFlow monitoring system consists of an sFlow Agent which is embedded in a switch or router and an sFlow Collector.

feature sflow

Use this command to enable the **sFlow**¹ feature.

Use the no form to disable the sFlow feature.

Command Syntax

```
feature sflow
no feature sflow
```

Parameters

None

Default

Disabled.

Command Mode

Configure mode

Applicability

This command was introduced before OcNOS version 1.3.

Example

```
(config)#feature sflow
```

¹Sampled Flow data sFlow (sFlow) is the standard for monitoring high-speed switched and routed networks. The sFlow monitoring system consists of an sFlow Agent which is embedded in a switch or router and an sFlow Collector.

sflow agent-ip

Use this command to set the agent IP address for receivers.

Use the `no` form of this or remove an agent IP address.

Command Syntax

```
sflow agent-ip A.B.C.D  
no sflow agent-ip
```

Parameter

A.B.C.D

IPv4 address

Default

The default IP address is zero (0).

Command Mode

Configure mode

Applicability

This command was introduced before OcNOS version 1.3.

Example

```
#configure terminal  
(config)#sflow agent-ip 10.0.0.12
```

sflow collector

Use this command to configure the collector details such as the collector IPv4 address, port number, receiver time-out and datagram size.

Use the **no** form of this command to disable the **sFlow**¹ collector.

Command Syntax

```
sflow (collector-id <1-5>|) collector A.B.C.D port <1024-65535> receiver-time-out <0-2147483647> max-  
datagram-size <200-9000> (vrf WORD|)  
no sflow collector (A.B.C.D port <1024-65535>|)
```

Parameter

collector-id <1-5>

(Optional) Specifies the name of the Collector instance identifier. If the collector-id is not specified, the ID will be 1.

collector A.B.C.D

Collector IPv4 address. This address must be reachable via the management **VRF**². <1024-65535>

port <1024-65535>

Collector **UDP**³ Port number. The default port number is 6343.

receiver-time-out <0-2147483647>

Receiver time out value in seconds. Zero means no timeout. Upon timeout, value collector information is removed, stopping any ongoing sampling.

max-datagram-size <200-9000>

Maximum datagram size in bytes that can be sent to the collector.

vrf WORD

(Optional) Specifies the User defined VRF to reach the collector.

Default

Disabled.

Command Mode

Configure mode

Applicability

This command was introduced before OcNOS version 1.3. Introduced the `collector-id` and `vrf` parameters in the OcNOS version 6.5.1.

¹Sampled Flow data sFlow (sFlow) is the standard for monitoring high-speed switched and routed networks. The sFlow monitoring system consists of an sFlow Agent which is embedded in a switch or router and an sFlow Collector.

²Virtual Routing and Forwarding

³User Datagram Protocol

Example

```
#configure terminal
(config)#sflow collector 2.2.2.2 port 1111 receiver time-out 30 max-datagram-size 500

(config)#no sflow collector
```

```
OcNOS(config)#interface xe12
OcNOS(config-if)#sflow sampling-rate 1024 direction ingress max-header-size 256
OcNOS(config-if)#sflow enable
OcNOS(config-if)#sflow poll-interval 10
OcNOS(config-if)#sflow collector-id 3
```

sflow enable

Use this command to enable or disable sampling on an interface after giving the [sflow sampling-rate \(page 752\)](#) command on the same interface.

Command Syntax

```
sflow enable
no sflow enable
```

Parameters

None

Default

Disabled.

Command Mode

Interface mode

Applicability

This command was introduced before OcNOS version 1.3.

Example

```
(config)#interface xe1
(config-if)#sflow sampling-rate 1024 direction ingress max-datagram-size 200
(config-if)#sflow enable
(config-if)#no sflow enable
```

sflow poll-interval

Use this command to configure the **sFlow**¹ counter polling interval on all interfaces that have command sflow enabled, but do not have sflow poll-interval configured on interface level. This shall be overridden by the interface-specific configuration, see sflow poll-interval configuration on interface level.

Any change in the polling interval restarts ongoing polling of existing data source interfaces, if any.

Use *no* parameter of this command to remove this configuration.

Use show sflow global to verify this configuration.

Command Syntax

```
sflow poll-interval <5-60>
no sflow poll-interval
```

Parameters

<5-60>

Interface counter. Polling interval in seconds

Default

By default, sFlow counter polling interval is disabled.

Command Mode

Interface modeConfigure mode

Applicability

This command was introduced before OcNOS version 1.3.

Examples

```
OcNOS#configure terminal
Enter configuration commands, one per line. End with CNTL/Z.
OcNOS(config)#sflow poll-interval 60
OcNOS(config)#sflow sampling-rate 3000 direction ingress max-header-size 35
OcNOS(config)#sflow sampling-rate 2000 direction egress max-header-size 30
OcNOS(config)#
OcNOS(config)#interface eth1
OcNOS(config-if)#sflow enable
OcNOS(config-if)#exit
OcNOS(config)#commit
OcNOS#show sflow brief
sFlow Feature: Enabled
sFlow Port Configuration:
Interface  Collector  Status      Sample Rate      Counter-Polling
         ID      Ingress    Egress    Ingress    Egress    Interval (sec)
-----
eth1      0      Enabled    Disabled    3000      2000      60
```

¹Sampled Flow data sFlow (sFlow) is the standard for monitoring high-speed switched and routed networks. The sFlow monitoring system consists of an sFlow Agent which is embedded in a switch or router and an sFlow Collector.

sflow rate-limit

Use this command to set the CPU rate limit in packets per second.

Use the `no` form of this command to set the CPU rate limit to its default (0).

Command Syntax

```
sflow rate-limit <2000-100000>  
no sflow rate-limit
```

Parameters

<2000-100000>

Rate limit in packets per second

Default

The default rate limit is zero (0).

Command Mode

Configure mode

Applicability

This command was introduced before OcNOS version 1.3.

Examples

```
#configure terminal  
(config)#sflow rate-limit 5000
```

sflow sampling-rate

Use this command to set the sampling rate on all interfaces that have command sflow enabled, but do not have sflow sampling-rate configured on interface level. This shall be overridden by the interface-specific configuration, see sflow sampling-rate configuration on interface level.

Any change in the sampling rate restarts the ongoing sampling of existing data-source interfaces, if any.

Use *no* parameter of this command to remove this configuration.

Use show sflow global to verify this configuration.

Command Syntax

```
sflow sampling-rate <1024-16777215> direction (ingress | egress) max-header-size <16-256>
no sflow sampling-rate direction (ingress | egress)
```

Parameters

<1024-16777215>

Sampling rate

direction

The direction of sampling an interface:

ingress

Ingress traffic

egress

Egress traffic

<16-256>

Maximum header size in bytes

Default

Disabled.

Command Mode

Interface modeConfigure mode

Applicability

This command was introduced before OcNOS version 1.3.

Examples

```
cNOS#configure terminal
Enter configuration commands, one per line. End with CNTL/Z.
OcNOS(config)#sflow poll-interval 60
OcNOS(config)#sflow sampling-rate 3000 direction ingress max-header-size 35
OcNOS(config)#sflow sampling-rate 2000 direction egress max-header-size 30
OcNOS(config)#
OcNOS(config)#interface eth1
OcNOS(config-if)#sflow enable
OcNOS(config-if)#exit
```

```
OcNOS (config)#commit
OcNOS#show sflow brief
sFlow Feature: Enabled
sFlow Port Configuration:
Interface  Collector  Status      Sample Rate  Counter-Polling
          ID       Ingress     Egress       Ingress      Egress       Interval (sec)
-----
eth1      0      Enabled     Disabled     3000         2000         60
```

show sflow

Use this command to display **sFlow**¹ agent configuration along with statistics for all interfaces.

Command Syntax

```
show sflow (brief | detail)
```

Parameters

brief

Display configuration parameters on interfaces along with sampling rate and poll interval.

detail

Same as **brief** along with configured and default attributes and values of sFlow agent, sFlow collector, and sampling information.

Default

None

Command Mode

Execution mode

Applicability

This command was introduced before OcNOS version 1.3.

Example

```
#show sflow
sFlow Feature: Enabled
sFlow Version: 5
sFlow Global Information :
Agent      IP: 10.12.16.38
Collector IP: 2.2.2.2      Port: 6343
Maximum Datagram Size(bytes): 200
Receiver timeout(sec)      : 0

sFlow Port Detailed Information:
Interface Packet-Sampling      Packet-Sampling      Counter-Polling      Maximum
Header                                          Count                Interval            Count                Size(bytes)
          Rate
          Ingress      Egress
          Ingress
(sec)
-----
-----
xe1          1024          0          0          0          6          3          128
 0

#
#show sflow brief
```

¹Sampled Flow data sFlow (sFlow) is the standard for monitoring high-speed switched and routed networks. The sFlow monitoring system consists of an sFlow Agent which is embedded in a switch or router and an sFlow Collector.

```

sFlow Feature: Enabled
Collector IP: 2.2.2.2      Port: 6343
Maximum Datagram Size(bytes): 200
Receiver timeout(sec)    : 0

sFlow Port Configuration:
Interface  Status      Sample Rate      Counter-Polling
          Ingress  Egress          Ingress  Egress          Interval(sec)
-----
xe1       Enabled    Disabled        1024     0               6
    
```

Table 53. Show sflow output

Entry	Description
sFlow feature	Shows whether sFlow is enabled or disabled.
sFlow Version	Displays the sFlow version. Version 5 is the current global standard.
sFlow Global Information	Global Information consists of the Agent IP address, Collector IP, Port number, Maximum Datagram Size, and the Receiver timeout.
Agent IP	IPv4 address of this switch/router.
Collector IP	IPv4 address of the sFlow collector server.
Port	Port number on the sFlow collector server. Standard is port 6343.
Maximum Datagram Size	The maximum size of the datagrams sent by the agent
Receiver timeout	The number of seconds between each sampling – zero means sample continuously.
sFlow Port Interface	The interface of this switch/router on which sFlow is running (e.g. xe1/1).
Packet-Sampling Rate	the number of packets received or transmitted before a sample is taken.
Packet-Sampling Count	The number of sample packets that have been sampled on both the ingress and egress of the interface.
Counter-Polling	Shows the amount of time between polling samples and the count of the total number of polling samples taken.
Maximum Header Size	The maximum header size for both the ingress and egress of the interface.

show sflow interface

Use this command to display the **sFlow**¹ configuration for the input interface.

Command Syntax

```
show sflow interface IFNAME
```

Parameters

IFNAME

Interface name

Default

None

Command Mode

Execution mode

Applicability

This command was introduced before OcNOS version 1.3.

Example



Note: For information on the output values of this command, see the [show sflow \(page 754\)](#) command.

```
#show sflow interface xe1
sFlow feature: Enabled
sFlow Version: 5
sFlow Global Information :
Agent      IP: 10.10.26.104
Collector IP: 2.2.2.2      Port: 6343
Maximum Datagram Size(bytes): 200
Receiver timeout(sec)      : 0
sFlow Port Detailed Information:
Interface  Packet-Sampling      Counter-Polling      Maximum Header
          Rate          Count                Interval(sec) Count    Size(bytes)
-----
xe1        1024                0                    6          41      128
```

¹Sampled Flow data sFlow (sFlow) is the standard for monitoring high-speed switched and routed networks. The sFlow monitoring system consists of an sFlow Agent which is embedded in a switch or router and an sFlow Collector.

show sflow global

Use this command to display **sFlow**¹ global configuration information along with interface.

Command Syntax

```
show sflow global
```

Parameters

None

Default

None

Command Mode

Configure mode

Applicability

This command was introduced in OcNOS version 6.6.0.

Example



Note: For information on the output values of this command, see the [show sflow \(page 754\)](#) command.

```
OcNOS#show sflow global
sFlow Feature: Enabled
sFlow Version: 5
Agent IP      : 10.16.142.129

sFlow Port Global Information:
Packet-Sampling   Polling   Maximum Header
  Rate           Interval   Size (bytes)
Ingress  Egress      (sec)    Ingress  Egress
-----
      2000      3000      60       16       30

Interfaces using sFlow global configuration:
Interface  Packet-Sampling  Polling  Maximum Header
           Rate      Interval      Size
           Ingress  Egress      Ingress  Egress
-----
xe6         yes      yes      yes      yes      yes
```

¹Sampled Flow data sFlow (sFlow) is the standard for monitoring high-speed switched and routed networks. The sFlow monitoring system consists of an sFlow Agent which is embedded in a switch or router and an sFlow Collector.

show sflow statistics

Use this command to display **sFlow**¹ counter information.

Command Syntax

```
show sflow statistics (interface IFNAME|)
```

Parameters

IFNAME

Interface name.

Default

None

Command Mode

Execution mode

Applicability

This command was introduced before OcNOS version 1.3.

Example



Note: For information on the output values of this command, see the [show sflow \(page 754\)](#) command.

```
#show sflow statistics
sFlow Port Statistics:
Interface  Packet-Sampling  Counter-Polling
          Count      Count
-----  -
xe1              0              19
```

¹Sampled Flow data sFlow (sFlow) is the standard for monitoring high-speed switched and routed networks. The sFlow monitoring system consists of an sFlow Agent which is embedded in a switch or router and an sFlow Collector.

Control Plane Policing Commands

This chapter is a reference for the Control Plane Policing (CoPP) commands.

class-map type	760
class type copp	761
clear interface cpu counters	762
copp service-policy	763
cpu-queue	764
match access-group	767
ip copp access-list	768
ip copp access-list icmp	770
ip copp access-list tcp udp	774
police	780
policy-map	781
show interface cpu counters queue-stats	782
show cpu-queue details	783

class-map type

Use this command to create a class map for Control Plane Policing (CoPP), enabling the classification of control plane traffic based on specific matching criteria.

Use the `no` command to remove a class-map.

Command Syntax

```
class-map type copp match-any NAME
no class-map type copp match-any NAME
```

Parameter

NAME

Specify the class map name (maximum length 32 characters).

match-any

Match any parameter (boolean OR)

Default

None

Command Mode

Configure mode

Applicability

This command was introduced OcNOS version 6.6.0 .

Examples

```
#configure terminal
OcNOS(config)#class-map type copp match-any COPP-CM-PERMIT
```

class type copp

Use this command to Use this command to enter to class-mode under copp type policy map.

Use the no command to remove class-mode under copp type policy map..

Command Syntax

```
class type copp <NAME>
no class type copp <NAME>
```

Parameter

NAME

Specify the class map name.

Default

None

Command Mode

Policy¹-map mode

Applicability

This command was introduced OcNOS version 6.6.0 .

Examples

```
OcNOS(config)#policy-map type copp COPP-PM
OcNOS(config-pmap-copp)#class type copp COPP-CM
OcNOS(config-pmap-c-copp)#police cir 22 kbps
OcNOS(config-pmap-c-copp)#exit
```

s

¹A set of rules determining which actions are permitted or denied for a specific user role.

clear interface cpu counters

Use this command to clear the CPU queue counters.

Command Syntax

```
clear interface cpu counters
```

Parameters

None

Default

None

Command Mode

Execution mode and Privileged execution mode

Applicability

This command was introduced before OcNOS version 1.3.

Example

```
OcNOS#clear interface cpu counters
```

copp service-policy

Use this command to install CoPP type service policy in the hardware.

Use the `no` command to uninstall to CoPP type service policy in the hardware.

Command Syntax

```
copp service-policy NAME
no copp service-policy
```

Parameter

NAME

The policy map name that defines how traffic is classified and treated (For example: policing, dropping, or prioritizing).

Default

None

Command Mode

Configure mode

Applicability

This command was introduced OcNOS version 6.6.0 .

Examples

```
OcNOS(config)#copp service-policy CoPP-POLICY
```

cpu-queue

Use this command to set the protocol queue shaper and enable/disable queue monitoring for drop.

Command Syntax

```
cpu-queue (acl|arp|best-effort|bgp|bpdu|ccm|dhcp|daivm|igmp|ipmc-miss|isis|l3-  
miss|nd|ospf|pim|ptp|rip|sflow|bfd| vrrp|vxlan) (lossy | lossless|) (monitor|no-monitor|) (rate <0-  
100000>|)  
no cpu-queue (acl|arp|best-effort|bgp|bpdu|ccm|dhcp|daivm|igmp|ipmc-miss|isis|l3-  
miss|nd|ospf|pim|ptp|rip|sflow|bfd| vrrp|vxlan) (lossy | lossless|) (monitor|no-monitor|) (rate <0-  
100000>|)
```

Parameters

acl

Defines the parameters for the ACL queue.

arp

Defines the parameters for the ARP queue.

best-effort

Defines the parameters for the best-effort queue.

bgp

Defines the parameters for the BGP queue.

bpdu

Defines the parameters for the BPDU queue.

ccm

Defines the parameters for the CCM error queue.

dhcp

Defines the parameters for the **DHCP**¹ queue.

daivm

Defines the parameters for the DAIVM queue.

igmp

Defines the parameters for the IGMP queue.

ipmc-miss

Defines the parameters for the IPMC-miss queue.

isis

Defines the parameters for the ISIS queue.

l3-miss

Defines the parameters for the L3-miss queue.

mgmt-route-leak

Defines the parameters for the Management route leak queue.

nd

Defines the parameters for the ND queue.

ospf

Defines the parameters for the OSPF queue.

¹Dynamic Host Configuration Protocol

pim

Defines the parameters for the PIM queue.

ptp

Defines the parameters for the PTP queue.

rip

Defines the parameters for the RIP queue.

sflow

Defines the parameters for the Sflow queue.

bfd

Defines the parameters for the BFD queue.

vrrp

Defines the parameters for the VRRP queue.

vxlan

Disables monitoring of VXLAN queue usage.

lossy

Defines CPU queue as lossy.

lossless

Defines CPU queue as lossless.

monitor

Monitor CPU queue usage. If the rate is exceeded, packets start dropping in the CPU queue. These drops are reported to the user through notifications.

no-monitor

Disables monitoring of CPU queue usage.

rate

Sets the CPU queue rate within the range of 0 to 100,000.

Default

CPU queues are set with the default values, as shown in Table P-4-39.

Command Mode

Execution mode and Privileged execution mode

Applicability

This command was introduced before OcNOS version 1.3.8.

Example

Use the following command to configure BPDU rate/monitor/no-monitor for protocol queues:

```
OcNOS#configure terminal
OcNOS#cpu-queue bpdu rate 500 lossy no-monitor
```

Use the following command to verify the rate received on each protocol queue:

```
OcNOS#show interface cpu counters rate kbps

Load interval: 30 second
+-----+-----+-----+-----+-----+
| CPU Queue(%) | Rx kbps | Rx pps | Tx kbps | Tx pps |
+-----+-----+-----+-----+-----+
```

```
+-----+-----+-----+-----+
bpdu      ( 99%) -           -           31.97           499
```

Use the following command to verify the maximum, configured, and default configuration values:

```
OcNOS#show cpu-queue details
Cpu queue
Name           Configured  Rate In PPS      Monitor Status  Lossy Status
=====
=====
=====
best-effort    -           2113            2113            - * no-monitor   - * lossy
ipmc-miss      -           2113            2113            - * no-monitor   - * lossy
l3-miss        -           211             211             - * no-monitor   - * lossy
sflow          -           32000           100000          - monitor        - * lossy
bgp
  lossless
vrrp           -           1024            1024            - monitor        -
  lossless
rip            -           500             500             - monitor        -
  lossless
ospf           -           2000            2000            - monitor        -
  lossless
dhcp           -           100             2048            - no-monitor     - lossy
nd             -           6000            6000            - monitor        -
  lossless
pim            -           4000            4000            - * no-monitor   - * lossy
arp            -           6000            6000            - monitor        -
  lossless
igmp           -           4000            4000            - * no-monitor   - * lossy
bpdu           500         10000           10000           no-
monitor        monitor        lossy           lossless
ccm            -           1000            1000            - no-monitor     - lossy
bfd            -           2000            2000            - no-monitor     - lossy
ptp            -           1000            1000            - no-monitor     - lossy
isis           -           500             1000            - monitor        -
  lossless
trill-isis     -           1000            1000            - monitor        -
  lossless
acl            -           200             1000            - * no-monitor   - * lossy
vxlan          -           500             500             - monitor        - lossy
daivm          -           100             500             - no-monitor     - lossy
```

match access-group

Use this command to classify the packets based on the access group.

Use the `no` command to remove access group match criteria from a class map.

**Notes:**

- Match access-group is allowed only in “match-any” class type.
- When match access-grp is configured, no more match criteria can be supported in the class-map.

Command Syntax

```
match access-group NAME
no match access-group NAME
```

Parameter

NAME

Specify the access group name.

Default

None

Command Mode

Class-map copp mode

Applicability

This command was introduced OcNOS version 6.6.0 .

Examples

```
(config)#class-map type copp match-any class_acl
(config-copp-match-any)#match access-group my_acl
```

ip copp access-list

Use this command to define access-list of type CoPP .

Use the **no** form of this command to remove an ACL.

Command Syntax

```
ip copp access-list NAME (<1-268435453>|)
(deny|permit)
(igmp|ipip|ipv6ip|rsvp|gre|esp|ahp|eigrp|ospf|pim|ipcomp|vrrp|any|<0-255>)
(A.B.C.D/M|A.B.C.D A.B.C.D|host A.B.C.D|any)
(A.B.C.D/M|A.B.C.D A.B.C.D|host A.B.C.D|any)
(fragments|)
(ttl <0-255>|)
(ip-options|)
no ip copp access-list NAME (<1-268435453>|)
(deny|permit)
(igmp|ipip|ipv6ip|rsvp|gre|esp|ahp|eigrp|ospf|pim|ipcomp|vrrp|any|<0-255>)
(A.B.C.D/M|A.B.C.D A.B.C.D|host A.B.C.D|any)
(A.B.C.D/M|A.B.C.D A.B.C.D|host A.B.C.D|any)
(fragments|)
(ttl <0-255>|)
(ip-options|)
no ip copp access-list NAME (<1-268435453>|)
```

Parameters

<1-268435453>

IPv4 ACL sequence number.

deny

Drop the packet.

permit

Accept the packet.

<0-255>

IANA assigned protocol number.

any

Any protocol packet.

ahp

Authentication Header packet.

eigrp

Enhanced Interior Gateway Routing Protocol packet.

esp

Encapsulating Security Payload packet.

gre

Generic Routing Encapsulation packet.

ipip

IPv4 over IPv4 encapsulation packet.

ipcomp

IP Payload Compression Protocol packet.

ipv6ip

IPv6 over IPv4 encapsulation packet.

ospf

Open Shortest Path First packet.

pim

Protocol Independent Multicast packet

rsvp

Resource Reservation Protocol packet.

vrrp

Virtual Router Redundancy Protocol packet.

A.B.C.D/M

Source IP prefix and length.

A.B.C.D A.B.C.D

Source IP address and mask.

host A.B.C.D

A single source host IP address.

any

Match any source IP address.

A.B.C.D/M

Destination IP prefix and length.

A.B.C.D A.B.C.D

Destination IP address and mask.

host A.B.C.D

A single destination host IP address.

any

Match any destination IP address.

fragments

Matches fragmented packets..

ttl <0-255>

Filters packets based on Time-To-Live (TTL) value.

ip-options

Matches packets containing IP options (used for security policies).

Default

None

Command Mode

Configure mode

Applicability

This command was introduced in OcNOS version 6.6.0

Examples

```
#configure terminal
```



```
OcNOS(config)#ip copp access-list COPP-ACL
OcNOS(config-ip-copp-acl)#permit any any any 34
```

ip copp access-list icmp

Use this command to permit or deny **ICMP**¹ packets based on the given source and destination IP address.

Use the **no** form of this command to remove an ACL specification.



Note: Configuring same filter again with change of sequence number or change of action will result in update of sequence number or filter action.

Command Syntax

```
(<1-268435453>|)
(deny|permit)
icmp
(A.B.C.D/M|A.B.C.D A.B.C.D|host A.B.C.D|any)
(A.B.C.D/M|A.B.C.D A.B.C.D|host A.B.C.D|any)
<0-255>
(fragments|)
ttl <0-255>|)
(ip-options|)
no (<1-268435453>|)
(deny|permit)
icmp
(A.B.C.D/M|A.B.C.D A.B.C.D|host A.B.C.D|any)
(A.B.C.D/M|A.B.C.D A.B.C.D|host A.B.C.D|any)
<0-255>
(fragments|)
ttl <0-255>|)
(ip-options|)
```

Parameters

<1-268435453>

IPv4 ACL sequence number.

deny

Drop the packet.

permit

Accept the packet.

icmp

Internet Control Message Protocol packet.

A.B.C.D/M

Source IP prefix and length.

A.B.C.D A.B.C.D

Source IP address and mask.

host A.B.C.D

A single source host IP address.

¹Internet Control Message Protocol (ICMP) is a fundamental protocol used in networking to relay error messages and operational information.

any

Match any source IP address.

A.B.C.D/M

Destination IP prefix and length.

A.B.C.D A.B.C.D

Destination IP address and mask.

host A.B.C.D

A single destination host IP address.

any

Match any destination IP address.

fragments

Matches fragmented packets..

ttl <0-255>

Filters packets based on Time-To-Live (TTL) value.

ip-options

Matches packets containing IP options (used for security policies).

administratively-prohibited

Administratively prohibited.

alternate-address

Alternate address.

conversion-error

Datagram conversion.

dod-host-prohibited

Host prohibited.

dod-net-prohibited

Net prohibited.

echo

Echo (ping).

echo-reply

Echo reply.

general-parameter-problem

Parameter problem.

host-isolated

Host isolated.

host-precedence-unreachable

Host unreachable for precedence.

host-redirect

Host redirect.

host-tos-redirect

Host redirect for ToS.

host-tos-unreachable

Host unreachable for ToS.

host-unknown

Host unknown.

host-unreachable

Host unreachable.

information-reply

Information replies.

information-request

Information requests.

mask-reply

Mask replies.

mask-request

Mask requests.

mobile-redirect

Mobile host redirect.

net-redirect

Network redirect.

net-tos-redirect

Net redirect for ToS.

net-tos-unreachable

Network unreachable for ToS.

net-unreachable

Net unreachable.

network-unknown

Network unknown.

no-room-for-option

Parameter required but no room.

option-missing

Parameter required but not present.

packet-too-big

Fragmentation needed and DF set.

parameter-problem

All parameter problems.

port-unreachable

Port unreachable.

precedence-unreachable

Precedence cutoff.

protocol-unreachable

Protocol unreachable.

reassembly-timeout

Reassembly timeout.

redirect

All redirects.

router-advertisement

Router discovery advertisements.

router-solicitation

Router discovery solicitations.

source-quench

Source quenches.

source-route-failed

Source route failed.

time-exceeded

All time-exceeded messages.

timestamp-reply

Time-stamp replies.

timestamp-request

Time-stamp requests.

traceroute

Traceroute.

ttl-exceeded

TTL exceeded.

unreachable

All unreachables.

<0-255>

ICMP type.

<0-255>

ICMP code.

log

Log the packets matching the filter (in-direction only). sample Sample the packets matching the filter (in-direction only).

sample

Sample the packets matching the filter (in-direction only).

redirect-to-port

Redirect the packet (in-direction only)

IFNAME

Interface name to which packet to be redirected (switchport only)

Default

None

Command Mode

IP access-list mode

Applicability

This command was introduced beforeOcNOS version 6.6.0 .

Examples

```
#configure terminal
(config)#ip copp access-list ip-icmp
(config-ip-copp-acl)#200 permit icmp any any
```

ip copp access-list tcp|udp

Use this command to define a named copp access control list (ACL) that determines whether to accept or drop an incoming TCP or UDP¹ IP packet based on the specified match criteria. This form of command filters packets based on source and destination IP address along with protocol (TCP or UDP) and port.

Use the **no** form of this command to remove an ACL specification.



Note: Configuring same filter again with change of sequence number or change of action will result in update of sequence number or filter action.

Command Syntax

```
(<1-268435453>|) (deny|permit) tcp (A.B.C.D/M|A.B.C.D A.B.C.D|host A.B.C.D|any) ((eq|gt|lt|neq) (<0-65535>|bgp|chargen|cmd|daytime|discard|domain|drip|echo|exec|finger|ftp|ftp-data|gopher|hostname|ident|irc|klogin|kshell|login|lpd|nntp|pim-auto-rp|pop2|pop3|smtp|ssh|sunrpc|tacacs|talk|telnet|time|uucp|whois|www) | range <0-65535> <0-65535>|) (A.B.C.D/M|A.B.C.D A.B.C.D|host A.B.C.D|any) ((eq|gt|lt|neq) (<0-65535>|bgp|chargen|cmd|daytime|discard|domain|drip|echo|exec|finger|ftp|ftp-data|gopher|hostname|ident|irc|klogin|kshell|login|lpd|nntp|pim-auto-rp|pop2|pop3|smtp|ssh|sunrpc|tacacs|talk|telnet|time|uucp|whois|www) | range <0-65535> <0-65535>|) ((dscp (<0-63>| af11| af12| af13| af21| af22| af23| af31| af32| af33| af41| af42| af43| cs1| cs2| cs3| cs4| cs5| cs6| cs7| default| ef)) | (precedence (<0-7>| critical| flash | flashoverride| immediate| internet| network| priority| routine)) |) ({ack|established|fin|psh|rst|syn|urg|}) (fragments|) (vlan <1-4094>|) (inner-vlan <1-4094>|) (log|) (sample|) ((redirect-to-port IFNAME)|)
```

```
(<1-268435453>|) (deny|permit) udp (A.B.C.D/M|A.B.C.D A.B.C.D|host A.B.C.D|any) ((eq|gt|lt|neq) (<0-65535>|biff|bootpc|bootps|discard|dnsex|domain|echo|isakmp|mobile-ip|nameserver|netbios-dgm|netbios-ns|netbios-ss|non500-isakmp|ntp|pim-auto-rp|snmp|snmptrap|sunrpc|syslog|tacacs|talk|tftp|time|who|xdmcp) | range <0-65535> <0-65535>|) (A.B.C.D/M|A.B.C.D A.B.C.D|host A.B.C.D|any) ((eq|gt|lt|neq) (<0-65535>|biff|bootpc|bootps|discard|dnsex|domain|echo|isakmp|mobile-ip|nameserver|netbios-dgm|netbios-ns|netbios-ss|non500-isakmp|ntp|pim-auto-rp|snmp|snmptrap|sunrpc|syslog|tacacs|talk|tftp|time|who|xdmcp) | range <0-65535> <0-65535>|) ((dscp (<0-63>| af11| af12| af13| af21| af22| af23| af31| af32| af33| af41| af42| af43| cs1| cs2| cs3| cs4| cs5| cs6| cs7| default| ef)) | (precedence (<0-7>| critical| flash | flashoverride| immediate| internet| network| priority| routine))|) (fragments|) (vlan <1-4094>|) (inner-vlan <1-4094>|) (log|) (sample|)
```

```
no (<1-268435453>|) (deny|permit) tcp (A.B.C.D/M|A.B.C.D A.B.C.D|host A.B.C.D|any) ((eq|gt|lt|neq) (<0-65535>| bgp| chargen| cmd| daytime| discard| domain| drip| echo|exec|finger|ftp|ftp-data|gopher|hostname|ident|irc|klogin|kshell|login|lpd|nntp|pim-auto-rp|pop2|pop3|smtp|ssh|sunrpc|tacacs|talk|telnet|time|uucp|whois|www) | range <0-65535> <0-65535>|) (A.B.C.D/M|A.B.C.D A.B.C.D|host A.B.C.D|any) ((eq|gt|lt|neq) (<0-65535>|bgp|chargen|cmd|daytime|discard|domain|drip|echo|exec|finger|gopher|hostname|ident|irc|klogin|kshell|login|lpd|nntp|pim-auto-rp|pop2|pop3|smtp|ssh|sunrpc|tacacs|talk|telnet|time|uucp|whois|www) | range <0-65535> <0-65535>|) ((dscp (<0-63>| af11| af12| af13| af21| af22| af23| af31| af32| af33| af41| af42| af43| cs1| cs2| cs3| cs4| cs5| cs6| cs7| default| ef)) | (precedence (<0-7>| critical| flash | flashoverride| immediate| internet| network| priority| routine)) |) ({ack|established|fin|psh|rst|syn|urg|}) (fragments|) (vlan <1-4094>|) (inner-vlan <1-4094>|) (log|) (sample|) ((redirect-to-port IFNAME)|)
```

```
no (<1-268435453>|) (deny|permit) udp (A.B.C.D/M|A.B.C.D A.B.C.D|host A.B.C.D|any) ((eq|gt|lt|neq) (<0-65535>| biff| bootpc| bootps| discard| dnsex| domain| echo| isakmp|mobile-ip|nameserver|netbios-dgm|netbios-ns|netbios-ss|non500-isakmp|ntp|pim-auto-rp|snmp|snmptrap|sunrpc|syslog|tacacs|talk|tftp|time|who|xdmcp) | range <0-65535> <0-65535>|) (A.B.C.D/M|A.B.C.D A.B.C.D|host A.B.C.D|any) ((eq|gt|lt|neq) (<0-65535>|biff|bootpc|bootps|discard|dnsex|domain|echo|isakmp|mobile-ip|nameserver|netbios-dgm|netbios-ns|netbios-ss|non500-isakmp|ntp|pim-auto-rp|snmp|snmptrap|sunrpc|syslog|tacacs|talk|tftp|time|who|xdmcp) | range <0-65535> <0-65535>|) ((dscp (<0-63>| af11| af12| af13| af21| af22| af23| af31| af32| af33| af41| af42| af43| cs1| cs2| cs3| cs4| cs5| cs6| cs7| default| ef)) | (precedence (<0-7>| critical| flash | flashoverride| immediate|
```

¹User Datagram Protocol

```
internet| network| priority| routine)) |) (fragments|)(vlan <1-4094>|)(inner-vlan <1-4094>|) (log|)
(sample|)((redirect-to-port IFNAME)|)
```

Parameters

<1-268435453>

IPv4 ACL sequence number.

deny

Drop the packet.

permit

Accept the packet.

tcp

Transmission Control Protocol.

udp

User Datagram Protocol.

A.B.C.D/M

Source or destination IP prefix and length.

A.B.C.D A.B.C.D

Source or destination IP address and mask.

host A.B.C.D

Source or destination host IP address.

any

Any source or destination IP address.

eq

Source or destination port equal to.

<0-65535>

Source or destination port number.

range

Range of source or destination port numbers:

<0-65535>

Lowest value in the range.

<0-65535>

Highest value in the range.

bgp

Border Gateway Protocol.

chargen

Character generator.

cmd

Remote commands.

daytime

Daytime.

discard

Discard.

domain

Domain Name Service.

drip

Dynamic Routing Information Protocol.

echo

Echo.

exec

EXEC.

finger

Finger.

ftp

File Transfer Protocol.

ftp-data

FTP data connections.

gopher

Gopher.

hostname

NIC hostname server.

ident

Ident Protocol.

irc

Internet Relay Chat.

klogin

Kerberos login.

kshell

Kerberos shell.

login

Login.

lpd

Printer service.

nntp

Network News Transport Protocol.

pim-auto-rp

PIM Auto-RP.

pop2

Post Office Protocol v2.

pop3

Post Office Protocol v3.

smtp

Simple Mail Transport Protocol.

ssh

Secure Shell.

sunrpc

Sun Remote Procedure Call.

tacacs

TAC Access Control System.

talk

Talk.

telnet

Telnet.

time

Time.

uucp

UNIX-to-UNIX Copy Program.

whois

WHOIS/NICNAME

www

World Wide Web.

netconf-ssh

Secure Shell Network Configuration

netconf-tls

Transport Layer Security Network Configuration

nntp

Range of source or destination port numbers:

ack

Match on the Acknowledgment (ack) bit.

established

Matches only packets that belong to an established TCP connection.

fin

Match on the Finish (fin) bit.

psh

Match on the Push (psh) bit.

rst

Match on the Reset (rst) bit.

syn

Match on the Synchronize (syn) bit.

urg

Match on the Urgent (urg) bit.

biff

Biff.

bootpc

Bootstrap Protocol (BOOTP) client.

bootps

Bootstrap Protocol (BOOTP) server.

discard

Discard.

dnsix

DNSIX security protocol auditing.

domain

Domain Name Service.

echo

Echo.

isakmp

Internet Security Association and Key Management Protocol.

mobile-ip

Mobile IP registration.

nameserver

IEN116 name service.

netbios-dgm

Net BIOS datagram service.

netbios-ns

Net BIOS name service.

netbios-ss

Net BIOS session service.

non500-isakmp

Non500-Internet Security Association and Key Management Protocol.

ntp

Network Time Protocol.

pim-auto-rp

PIM Auto-RP.

snmp

Simple Network Management Protocol.

snmptrap

SNMP Traps.

sunrpc

Sun Remote Procedure Call.

syslog

System Logger.

tacacs

TAC Access Control System.

talk

Talk.

tftp

Trivial File Transfer Protocol.

time

Time.

who

Who service.

xdmcp

X Display Manager Control Protocol.

fragments

Check non-initial fragments.

ttl <0-255>

Filters packets based on Time-To-Live (TTL) value.

ip-options

Matches packets containing IP options (used for security policies).

Default

None

Command Mode

IP access-list mode

Applicability

This command was introduced before OcNOS version 6.6.0.

Examples

```
#configure terminal
(config)#ip copp access-list ip-acl-02
(config-ip-copp-acl)#deny udp any any eq tftp
(config-ip-copp-acl)#deny tcp any any eq ssh
(config-ip-acl)#end
```

police

Use this command to configure policer to rate limit particular class of traffic.

Use the `no` command to remove a policing configuration.

Command Syntax

```
police (colour-aware|colour-blind) cir <1-2438400000> kbps|mbps|gbps
no police
```

Parameter

colour-blind

Do not police on color.

colour-aware

Do police on color.

cir

Committed information rate.

<1-2438400000>

Excess information rate values 22kbps-2438gbps.

kbps

Specify the units of kilobits per second.

mbps

Specify the units of megabits per second.

gbps

Specify the units of gigabits per second.

Default

colour-blind

Command Mode

Policy¹ map class Type copp mode

Applicability

This command was introduced OcNOS version 6.6.0 .

Examples

```
OcNOS(config)#policy-map type copp COPP-PM
OcNOS(config-pmap-copp)#class type copp COPP-CM
OcNOS(config-pmap-c-copp)#police cir 22 kbps
OcNOS(config-pmap-c-copp)#exit
```

¹A set of rules determining which actions are permitted or denied for a specific user role.

policy-map

Use this command to create a policy map and enter policy-map mode.

Use the `no` form of the command to remove a policy map.

Command Syntax

```
policy-map type copp NAME
no policy-map type copp NAME
```

Parameter

NAME

Specify a policy-map name (maximum 32 characters).

copp NAME

Specify a policy-map name.

Default

None

Command Mode

Configure mode

Applicability

This command was introduced OcNOS version 6.6.0 .

Examples

```
OcNOS(config)#policy-map type copp COPP-PM
OcNOS(config-pmap-copp)#class type copp COPP-CM
```

show interface cpu counters queue-stats

Use this command to display the counters of packets destined to the CPU.

Command Syntax

```
show interface cpu counters queue-stats
```

Parameters

None

Default

None

Command Mode

Execution mode and Privileged execution mode

Applicability

This command was introduced before OcNOS version 1.3.8.

Example

```
OcNOS#show interface cpu counter queu-stats
E - Egress, I - Ingress, Q-Size is in bytes
+-----+-----+-----+-----+-----+-----+
| Queue/Class-map | Q-Size | Tx pkts | Tx bytes | Dropped pkts | Dropped
bytes |
+-----+-----+-----+-----+-----+-----+
nd                (E) 0      17      1998      0          0
bpdu              (E) 86320 253462 16221568 69227330 4430536320
```

show cpu-queue details

Use this command to display CPU queue details.

Command Syntax

```
show cpu-queue details
```

Parameters

None

Default

None

Command Mode

Execution mode and Privileged execution mode

Applicability

This command was introduced before OcNOS version 1.3.8.

Example

Use the following command to configure rate/monitor/no-monitor for protocol queues:

```
OcNOS#show cpu-queue details
Can not configure the parameter
Cpu queue          Rate In PPS          Monitor Status          Lossy Status
Name              Configured  Default  Max Rate Allowed  Configured  Default  Configured  Default
=====
=====
best-effort        -           2113    2113              -           * no-monitor -          * lossy
ipmc-miss          -           2113    2113              -           * no-monitor -          * lossy
l3-miss            -           211     211               -           * no-monitor -          * lossy
sflow              -           32000   100000            -           monitor   -          * lossy
bgp                -           1500    1500              -           monitor   -
vrrp               lossless
vrrp               -           1024    1024              -           monitor   -
rip                lossless
rip                -           500     500               -           monitor   -
ospf               lossless
ospf               -           2000    2000              -           monitor   -
dhcp               lossless
dhcp               -           100     2048              -           no-monitor -          lossy
nd                 lossless
nd                 -           6000    6000              -           monitor   -
pim                lossless
pim                -           4000    4000              -           * no-monitor -          * lossy
arp                lossless
arp                -           6000    6000              -           monitor   -
igmp               lossless
igmp               -           4000    4000              -           * no-monitor -          * lossy
bpdu               lossless
bpdu               -           10000   10000             -           monitor   -
ccm                lossless
ccm                -           1000    1000              -           no-monitor -          lossy
bfd                lossless
bfd                -           2000    2000              -           no-monitor -          lossy
ptp                lossless
ptp                -           1000    1000              -           no-monitor -          lossy
isis               lossless
isis               -           500     1000              -           monitor   -
```

	lossless							
trill-isis	-	1000	1000	-	monitor	-		
	lossless							
acl	-	200	1000	-	* no-monitor	-	*	
lossy								
vxlan	-	500	500	-	monitor	-		
	lossy							
daivm	-	100	500	-	no-monitor	-		
	lossy							

Object Tracking Commands

This chapter describes the Object Tracking commands:

track ip sla reachability	786
delay up down	787
object tracking	788
show track	790
show track summary	791
show running-config track	792

track ip sla reachability

Use this command to configure an Object for tracking using IP SLA.

Use the **no** form of this command to delete to object tracking

Command Syntax

```
track <1-500> ip sla <1-65535> reachability)
no track <1-500> ip sla <1-65535> reachability
```

Parameters

object-number (1-500)

Identifier for the tracked object

ip-sla-number (1-65535)

Identifier for IP SLA association with tracking object

Command Mode

Configure mode

Applicability

This command is introduced in OcNOS version 5.1.

Example

```
#configure terminal
OcNOS(config)#track 1 ip sla 1 reachability
OcNOS(config-object-track)#commit

OcNOS(config)#no track 1
OcNOS(config)#commit
```

delay up down

Use This command is used to delay the state change notification of object tracking.

Use the `no` form of this command to remove delay the state change notification of object

Command Syntax

```
delay (up <1-9999>|) (down <1-9999>|)  
no delay (|up|down)
```

Parameters

<1-999>

Delay in Notification in seconds.

Default

None

Command Mode

Object tracking Mode

Applicability

This command is introduced in OcNOS version 5.1.

Example

```
OcNOS(config-object-track)#delay up 10 down 20  
OcNOS(config-object-track)#no delay  
OcNOS(config-object-track)#commit  
OcNOS(config-object-track)#  
OcNOS(config-object-track)#delay down 10  
OcNOS(config-object-track)#commit  
OcNOS(config-object-track)#no delay down  
OcNOS(config-object-track)#commit  
OcNOS(config-object-track)#  
OcNOS(config-object-track)#delay up 10  
OcNOS(config-object-track)#commit  
OcNOS(config-object-track)#no delay up  
OcNOS(config-object-track)#commit  
OcNOS(config-object-track)#
```

object tracking

Use this command to configure track IDs and options on the interfaces.

Use the no parameter with this command to remove the configurations.

These commands configure object tracking on interfaces, with specific track IDs and tracked objects set to determine what gets tracked and affects the interface's status.

The object-tracking command provides flexibility, enabling both all and any tracking behaviors for influencing the interface's status. A maximum of 8 track IDs can be configured per interface. It is possible to configure the same track IDs or options on multiple interfaces.

Command Syntax

```
object-tracking <1-500>
object-tracking <all | any>
no object-tracking <1-500>
no object-tracking <all | any>
```

Parameters

<1-500>

Object tracking ID

all

Boolean AND operation. Each object configured on the interface must be in an up state for the interface itself to be in an up state; otherwise, it will be brought down.

any

Boolean OR operation. At least one object configured on the interface must be in an up state; otherwise, the interface will be brought down.

Default

None

Command Mode

Interface mode

Applicability

This command is introduced in OcNOS version 6.4.1.

Example

Here are some example commands for configuring object tracking in the interface mode.

```
OcNOS(config)#int xe5
OcNOS(config-if)#object-tracking 10
OcNOS(config-if)#object-tracking all
OcNOS(config-if)#commit

OcNOS(config-if)#no object-tracking 10
OcNOS(config-if)#no object-tracking all
OcNOS(config-if)#commit
```

```
OcNOS (config-if) #exit
```

show track

Use this command to display Sham link information.

Command Syntax

```
show track <1-500>  
show track
```

Parameters

<1-500>

Object identifier

Default

None

Command Mode

Privileged execution mode and Execution mode

Applicability

This command is introduced in OcNOS version 5.1.

Example

```
OcNOS#sh track  
TRACK Id: 1  
  IP SLA 1 reachability  
  Reachability is DOWN  
    0 changes, last change : 2021 Dec 11 05:20:23  
OcNOS#
```

```
OcNOS#sh track 2  
TRACK Id: 2  
  IP SLA 2 reachability  
  Reachability is DOWN  
    0 changes, last change : 2021 Dec 11 05:29:49  
OcNOS#
```

show track summary

Use this command to display the summary of all object tracking.

Command Syntax

```
show track summary
```

Parameters

None

Default

None

Command Mode

Privileged execution mode and Execution mode

Applicability

This command is introduced in OcNOS version 5.1.

Example

```
OcNOS#sh track summary
Object Tracking Summary
ID      Type      Type-Identifier      State
-----
1       ip-sla    1                    DOWN
2       ip-sla    2                    DOWN
OcNOS#
```

show running-config track

Use this command to display object tracking running configuration alone.

Command Syntax

```
show running-config track
```

Parameters

None

Default

None

Command Mode

Privileged execution mode and Execution mode

Applicability

This command is introduced in OcNOS version 5.1.

Example

```
OcNOS#sh running-config track
track 1 ip sla 1 reachability
  delay up 20
!
track 2 ip sla 2 reachability
!
OcNOS#
```

IP Service Level Agreements Commands

IP Service Level Agreements (SLAs) is a diagnostic method which generates and analyses the traffic between an OcNOS device and your network. IP SLA monitors and reports network performance data which helps you to identify the actual root cause of a problem when the performance level drops.

This chapter describes the commands used to manage the IP SLA for **ICMP**¹ echo.

clear ip sla statistics	794
frequency	795
icmp-echo	796
ip sla	797
ip sla schedule	798
show ip sla statistics	799
show ip sla summary	801
show running-config ip sla	802
threshold	803
timeout	804

¹Internet Control Message Protocol (ICMP) is a fundamental protocol used in networking to relay error messages and operational information.

clear ip sla statistics

Use this command to clear the IP SLA statistics.

Command Syntax

```
clear ip sla statistics <1-65535>
```

Parameters

1-65535

IP SLA identifier

Default

None

Command Mode

Execution mode and Privileged execution mode

Applicability

This command was introduced in OcNOS version 5.0.

Examples

```
#clear ip sla statistics 1
```

frequency

Use this command to configure the frequency/interval to send **ICMP**¹ echo packets one by one. Use the **no** form of this command to remove the configured ICMP echo frequency.

Command Syntax

```
frequency <1-60>  
no frequency
```

Parameters

1-60

Frequency in seconds

Default

5 seconds

Command Mode

IP SLA ICMP Echo mode (config-ip-sla-echo)

Applicability

This command was introduced in OcNOS version 5.0.

Examples

```
#configure terminal  
(config)#ip sla 1  
(config-ip-sla)#icmp-echo ipv4 10.12.28.1 source-interface xe1  
(config-ip-sla-echo)#frequency 3
```

¹Internet Control Message Protocol (ICMP) is a fundamental protocol used in networking to relay error messages and operational information.

icmp-echo

Use this command to select and configure the **ICMP**¹ echo SLA operation. ICMP echo packets are constructed in the device and sent to the destination address that you specify. These packets are transferred on a specific interface by setting the **source-interface** parameter.

Use the **no** form of this command to un-configure or remove the configured ICMP echo measurement sessions.

Command Syntax

```
icmp-echo (ipv4 A.B.C.D|ipv6 X:X::X:X|HOSTNAME) (source-interface IFNAME|)
no icmp-echo (ipv4 A.B.C.D | ipv6 X:X::X:X | HOSTNAME)
```

Parameters

A.B.C.D

IPv4 address

X:X::X:X

IPv6 address

HOSTNAME

Host name

IFNAME

Source interface name

Default

None

Command Mode

IP SLA mode (config-ip-sla)

Applicability

This command was introduced in OcNOS version 5.0.

Examples

```
#configure terminal
(config)#ip sla 1
(config-ip-sla)#icmp-echo ipv4 10.12.28.1 source-interface xel
(config-ip-sla-echo)#
```

¹Internet Control Message Protocol (ICMP) is a fundamental protocol used in networking to relay error messages and operational information.

ip sla

Use this command to create an IP SLA instance. One instance maps to a single SLA operation. You can create multiple SLA operations to perform multiple similar or different SLA operations.

Use the **no** form of this command to remove a configured IP SLA configurations.

Command Syntax

```
ip sla <1-65535>  
no ip sla <1-65535>
```

Parameters

1-65535

IP SLA identifier

Default

None

Command Mode

Configure mode

Applicability

This command was introduced in OcNOS version 5.0.

Example

```
#configure terminal  
(config)#ip sla 1  
(config-ip-sla)#
```

ip sla schedule

Use this command to schedule an IP SLA operation by associating a [Time Range Commands](#) object with the IP SLA operation.

Use the **no** form of this command to stop the configured IP SLA measurement.

Command Syntax

```
ip sla schedule <1-65535> time-range WORD (vrf (NAME) |)
```

Parameters

<1-65535>

IP SLA identifier.

time-range

Time Range

TR_NAME

Time range name that you set with the [Time Range Commands](#) command.

vrf

VPN Routing/Forwarding instance

NAME

VPN Routing/Forwarding instance name. Maximum limit 32 characters

Default

None

Command Mode

Configure mode

Applicability

This command was introduced in OcNOS version 5.0.

Examples

```
#configure terminal
(config)#ip sla schedule 1 time-range t1 vrf v1
```

show ip sla statistics

Use this command to display the statistics of IP SLA measurement.

Command Syntax

```
show ip sla statistics (1-65535) detail
```

Parameters

1-65535

IP SLA identifier.

Default

None

Command Mode

Execution mode and Privileged execution mode

Applicability

This command was introduced in OcNOS version 5.0.

Examples

```
#show ip sla statistics 1 detail
=====
          IP SLA Statistics
=====
IP SLA ID           : 1
Start Time          : 2021 Aug 30 17:40:04
Elapsed time(milli sec) : 46015
Packets Sent       : 23
Packets Received   : 23
Packet Loss(%)     : 0.0000
Invalid Tests      : 0
Round Trip Delay(usec)
  Minimum          : 1000
  Maximum          : 1000
  Average          : 1000
```

Table 54. show ip sla statistics fields

Field	Description
IP SLA ID	IP SLA Identifier (1-65535)
Start Time	Measurement start time
Elapsed time(milli sec)	Time taken to complete the measurement in milliseconds
Packets Sent	Number of packet sent
Packets Received	Number of packet received

Table 54. show ip sla statistics fields (continued)

Field	Description
Packet Loss(%)	Packet lost in percentage
Invalid Tests	Received ICMP ¹ echo reply packets after configured threshold limit will be marked as invalid tests
Round Trip Delay(usec)	Round trip delay between ICMP echo request and ICMP echo reply: minimum, maximum and average round trip delay in microseconds

¹Internet Control Message Protocol (ICMP) is a fundamental protocol used in networking to relay error messages and operational information.

show ip sla summary

Use this command to display the summary of all IP SLA measurements.

Command Syntax

```
show ip sla summary
```

Parameters

None

Default

None

Command Mode

Execution mode and Privileged execution mode

Applicability

This command was introduced in OcNOS version 5.0.

Examples

```
#show ip sla summary
IPSLAs Latest Operation Summary
Codes: * active, ^ inactive
ID      Type      Destination      Stats      Return      Last
      (usec)      Code      Run
-----
^1      icmp-echo  20.2.2.3        0          OK          2021 Aug 23 13:53:37
```

Table 55. show ip sla summary fields

Field	Description
ID	IP SLA Identifier (1-65535)
Type	Measurement type
Destination	Destination address
Stats (usec)	Round trip time in microseconds for the measurement
Return Code	Measurement status
Last Run	Measurement last run date and time

show running-config ip sla

Use this command to display the IP SLA running configuration alone.

Command Syntax

```
show running-config ip sla
```

Parameters

None

Default

None

Command Mode

Execution mode and Privileged execution mode

Applicability

This command was introduced in OcNOS version 5.0.

Examples

```
#show running-config ip sla
ip sla 1
  icmp-echo ipv4 20.2.2.3
  frequency 2
  threshold 2000
  timeout 5000
ip sla schedule 1 time-range t1 vrf v1
```

threshold

Use this command to configure the threshold for every **ICMP**¹ echo packet.

Use the **no** form of this command to remove the configured ICMP echo threshold.

Command Syntax

```
threshold <1000-60000>  
no threshold
```

Parameters

1000-60000

Threshold in milliseconds.

Default

10000 milliseconds

Command Mode

IP SLA ICMP Echo mode (config-ip-sla-echo)

Applicability

This command was introduced in OcNOS version 5.0.

Examples

```
#configure terminal  
(config)#ip sla 1  
(config-ip-sla)#icmp-echo ipv4 10.12.28.1 source-interface xe1  
(config-ip-sla-echo)#threshold 5000
```

¹Internet Control Message Protocol (ICMP) is a fundamental protocol used in networking to relay error messages and operational information.

timeout

Use this command to configure the timeout for every **ICMP**¹ echo packet. Any packet arriving beyond this interval is considered to be lost.

Use the **no** form of this command to remove the configured ICMP echo timeout.

Command Syntax

```
timeout <1000-60000>  
no timeout
```

Parameters

1000-60000

Timeout in milliseconds.

Default

10000 milliseconds

Command Mode

IP SLA ICMP Echo mode (config-ip-sla-echo)

Applicability

This command was introduced in OcNOS version 5.0.

Examples

```
#configure terminal  
(config)#ip sla 1  
(config-ip-sla)#icmp-echo ipv4 10.12.28.1 source-interface xe1  
(config-ip-sla-echo)#timeout 5000
```

¹Internet Control Message Protocol (ICMP) is a fundamental protocol used in networking to relay error messages and operational information.

HARDWARE SYSTEM DIAGNOSE CONFIGURATION

- Show Tech Support Configurations 806
- Overview 806
 - Tech Support Samples 806
- Ethernet Interface Loopback Support 808
 - Overview 808
 - Local Loopback 808
 - Remote Loopback 809

Show Tech Support Configurations

Overview

IP Infusion Inc. maintains a collection of consolidated information about system configurations and statistics. This information is for debugging and diagnosing system issues, and can be uploaded to a remote server. You generate a file with this information via the `show techsupport` command.



Note: Output is not displayed on the terminal.

The default directory (`/var/log/`) is where the stored information is saved. The filename has the form: `tech_support_YYYY_MMM_DD_HH_MM_SS.tar.gz`. If a file name is specified, the information will be saved to `filename_YYYY_MMM_DD_HH_MM_SS_.tar.gz`. Date stamps are in the `YYYY_MM_DD` form, and time stamps are in the form `HH_MM_SS`.

The collected system data contains the following logs:

- Saved start-up configuration of the system.
- The `running-config`, and statistics for a specified module or all modules.
- The last 100 commands.
- Memory and CPU usage of the process.
- Process Id and process name.
- The user account running the process.

Tech Support Samples

<code>#show techsupport all</code>	Collects system configurations and statistics for all modules, and saves it in <code>tech_support_date_timestamp.tar.gz</code> in the <code>/var/log/</code> directory.
<code>#show techsupport all log-path /home/filename</code>	Collects system configurations and statistics for all modules, and saves it in <code>filename_date_timestamp.tar.gz</code> in the <code>/home/</code> directory.
<code>#show techsupport nsm</code>	Collects <code>nsm</code> protocol configurations and statistics, and saves it in <code>tech_support_date_timestamp.tar.gz</code> in the <code>/var/log/</code> directory.
<code>#show techsupport nsm log-path /home/filename</code>	Collects <code>nsm</code> protocol configurations and statistics, and saves it at <code>filename_date_timestamp.tar.gz</code> in the <code>/home/directory</code> .
<code>#show techsupport hostpd authd imi</code>	Collects <code>hostpd</code> , <code>authd</code> , and <code>imi</code> protocol configurations and statistics and saves it at <code>tech_support_date_timestamp.tar.gz</code> in the <code>/var/log/</code> directory.
<code>#show techsupport hostpd authd imi log-path</code>	Collects <code>hostpd</code> , <code>authd</code> , <code>imi</code> protocol configurations and

<code>/home/filename</code>	statistics, saves it as <code>filename_date_timestamp.tar.gz</code> in the <code>/home/</code> directory.
-----------------------------	---

Ethernet Interface Loopback Support

Overview

This feature support is to provide additional hardware diagnostic functionality for physical ports on boards. This feature will enable the user to determine if there are any issues in the physical port at the MAC and the PHY layer.

To achieve this functionality, the Ethernet interfaces can be configured as the loopback interfaces. Looping back the packets are possible either at MAC layer or at PHY layer. Also packets can be looped either from Egress to Ingress or Ingress to Egress. On enabling this feature, if all the TX packets are looped back to RX, it indicates there is no issue with the hardware at the particular layer configured, either MAC or PHY.

Local Loopback

Tx PHY Loopback

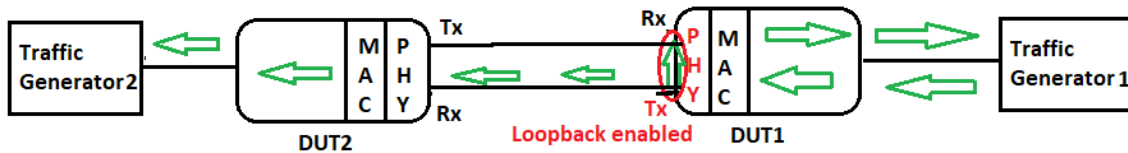

When the loopback Tx PHY is enabled on an Ethernet interface, packets that the traffic generator receives on such an interface are loop-backed to the originator and forwarded to the destination.

Because loopback is enabled as the Tx PHY in the diagram above, packets will loop at the physical layer, and the same number of packets will be returned to the traffic generator from the DUT's Egress to Ingress side. Thus, the Tx and Rx counts of receiving and transmitting interfaces are the same. The packets are looped and also forwarded to their next destination.

Tx MAC Loopback

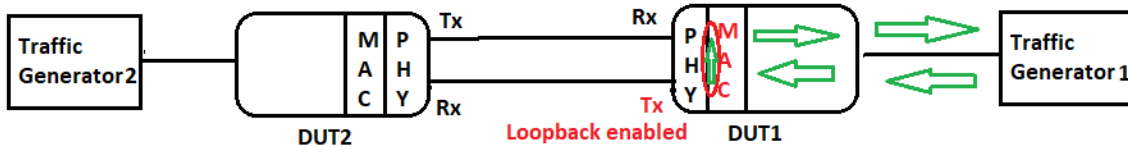

Loopback Tx MAC is enabled on the Ethernet interface, and when packets from the traffic generator arrive on such an interface, they are loop-backed to the originator rather than being forwarded.

In the above diagram, as loopback is enabled as a Tx MAC, the packets will loop at the MAC layer (data link layer), and the same number of packets are returned from the egress side to the ingress side of the DUT to the traffic generator. Thus, the Tx and Rx counts of receiving and transmitting interfaces are the same. The packets are looped but not forwarded further.

Remote Loopback

Rx PHY Loopback

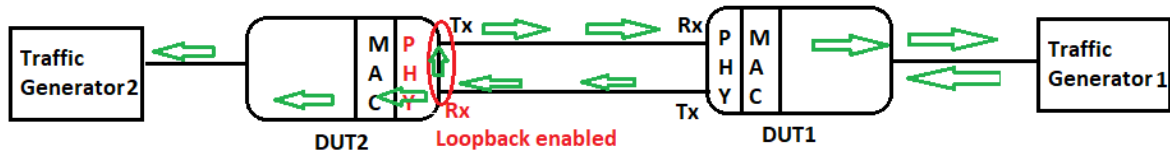

Loopback Rx PHY is enabled on the ethernet interface, and when packets from the traffic generator arrive at a remote node via such an interface, they are loop-backed to the originator and forwarded to the next route.

In the above diagram, as loopback is enabled as Rx PHY on DUT2, the packets will loop at the physical layer of the DUT2, and the same number of packets are returned from the ingress to the egress side of the DUT2 to DUT1 and the traffic generator. Thus, the Tx and Rx counts of receiving and transmitting interfaces are the same. The packets are looped back to Traffic Generator1 as well as forwarded to Traffic Generator2.

Rx MAC Loopback

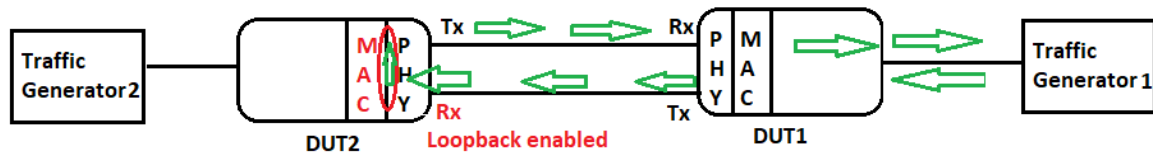

Loopback Rx MAC is enabled on the ethernet interface, and when packets from the traffic generator arrive at a remote node via such an interface, they are loop-backed to the originator but not forwarded to the next route.

In the above diagram, as loopback is enabled as Rx MAC on DUT2, the packets will loop at the MAC layer (data link layer) of the DUT2, and the same number of packets are returned from the ingress to the egress side of the DUT2 to DUT1 and the traffic generator. Thus, the Tx and Rx counts of receiving and transmitting interfaces are the same. The packets are looped back to Traffic Generator1, but not forwarded to Traffic Generator2.

Topology

Figure 50. Loopback configuration nodes



Configurations

R1

#configure terminal	Enter into the configure terminal mode.
---------------------	---

R1 (config) #hostname R1	Configure the hostname
R1 (config) #commit	Commit the configuration
R1 (config) #bridge 1 protocol rstp vlan-bridge	Configure bridge
R1 (config) #vlan database	Enter into vlan database
R1 (config-vlan) #vlan 2 bridge 1	Configure vlans
R1 (config-vlan) #exit	Exit the vlan database mode
R1 (config) #interface ce1/1	Enter into interface ce1/1
R1 (config-if) #switchport	Configure switchport
R1 (config-if) #bridge-group 1	Configure bridge-group
R1 (config-if) #switchport mode trunk	Configure switchport mode as trunk
R1 (config-if) #switchport trunk allowed vlan add 2	Add all the vlans to the interface
R1 (config-if) #exit	Exit the interface mode
R1 (config) #interface ce5/1	Enter into interface ce5/1
R1 (config-if) #switchport	Configure switchport
R1 (config-if) #bridge-group 1	Configure bridge-group
R1 (config-if) #switchport mode trunk	Configure switchport mode as trunk
R1 (config-if) #switchport trunk allowed vlan add 2	Add all the vlans to the interface
R1 (config-if) #loopback tx phy	Configure loopback tx phy
R1 (config-if) #exit	Exit the interface level
R1 (config) #no mac-address-table learning bridge 1 interface ce1/1	Disable the mac-learning on the device
R1 (config) #no mac-address-table learning bridge 1 interface ce5/1	Disable the mac-learning on the device
R1 (config) #commit	Commit the configuration
R1 (config) #exit	Exit from configuration mode

R2

#configure terminal	Enter into the configure terminal mode.
R2 (config) #hostname R2	Configure the hostname
R2 (config) #commit	Commit the configuration
R2 (config) #exit	Come out of configuration mode
R2#conf terminal	Enter into the configure terminal mode
R2 (config) #bridge 1 protocol rstp vlan-bridge	Configure bridge
R2 (config) #vlan database	Enter into vlan database
R2 (config-vlan) #vlan 2 bridge 1	Configure vlans
R2 (config-vlan) #exit	Exit the vlan database mode
R2 (config) #interface ce3/1	Enter into interface ce3/1

R2(config-if)#switchport	Configure switchport
R2(config-if)#bridge-group 1	Configure bridge-group
R2(config-if)#switchport mode trunk	Configure switchport mode as trunk
R2(config-if)#switchport trunk allowed vlan add 2	Add the vlan to the interface
R2(config-if)#exit	Exit the interface mode
R2(config-if)#interface ce29/1	Enter into interface ce29/1
R2(config-if)#switchport	Configure switchport
R2(config-if)#bridge-group 1	Configure bridge-group
R2(config-if)#switchport mode trunk	Configure switchport mode as trunk
R2(config-if)#switchport trunk allowed vlan add 2	Add the vlan to the interface
R2(config-if)#exit	Exit from interface level
R2(config)#no mac-address-table learning bridge 1 interface ce3/1	Disable the mac-learning on the device
R2(config)#no mac-address-table learning bridge 1 interface ce29/1	Disable the mac-learning on the device
R2(config)#commit	Commit the configuration
R2(config)#exit	Exit from configuration mode

Validation

R1

```

R1#show running-config interface ce1/1
!
interface ce1/1
  switchport
  bridge-group 1
  switchport mode trunk
  switchport trunk allowed vlan add 2
!
R1#show running-config interface ce5/1
!
interface ce5/1
  switchport
  bridge-group 1
  switchport mode trunk
  switchport trunk allowed vlan add 2
  loopback tx phy
!
R1# show interface ce5/1
Interface ce5/1
  Flexport: Breakout Control Port (Active): Break Out disabled
  Hardware is ETH Current HW addr: 34ef.b689.e04a
  Physical:34ef.b689.e04a Logical:(not set)
  Forward Error Correction (FEC) configured is Auto (default)
  FEC status is N/A
  Port Mode is trunk
  Interface index: 5045
  Metric 1 mtu 1500 duplex-full link-speed 40g
  Debounce timer: disable
  Loopback Type: PHY
  <UP,BROADCAST,RUNNING,MULTICAST>
  VRF Binding: Not bound
  DHCP client is disabled.

```

```

Last Flapped: 2021 Oct 23 15:57:01 (00:08:51 ago)
Statistics last cleared: 2021 Oct 23 15:54:44 (00:11:08 ago)
5 minute input rate 255 bits/sec, 0 packets/sec
5 minute output rate 255 bits/sec, 0 packets/sec
RX
  unicast packets 0 multicast packets 2272 broadcast packets 0
  input packets 2272 bytes 153730
  jumbo packets 0
  undersize 0 oversize 0 CRC 0 fragments 0 jabbers 0
  input error 0
  input with dribble 0 input discard 7
  Rx pause 0
TX
  unicast packets 0 multicast packets 4333 broadcast packets 0
  output packets 4333 bytes 293304
  jumbo packets 0
  output errors 0 collision 0 deferred 0 late collision 0
  output discard 0
  Tx pause 0
    
```

R1# show interface brief

```

-----
Ethernet  Type          PVID  Mode          Status Reason  Speed Port  Ctl Br/Bu Loopbk
Interface                                     Ch #
-----
ce5/1      ETH             1     trunk         up      none    10g  --    Br Yes  PHY
    
```

R2

```

R2#show running-config interface ce3/1
!
interface ce3/1
  switchport
  bridge-group 1
  switchport mode trunk
  switchport trunk allowed vlan add 2
!
    
```

```

R2#show running-config interface ce29/1
!
interface ce29/1
  switchport
  bridge-group 1
  switchport mode trunk
  switchport trunk allowed vlan add 2
!
R2#
    
```

Interface counters before configuring loopback on both the devices:

```

=====
R1#show interface counters rate gbps
+-----+-----+-----+-----+
| Interface | Rx gbps | Rx pps | Tx gbps | Tx pps |
+-----+-----+-----+-----+
| ce1/1     | 8.65    | 8446138 | 0.00    | 0       |
| ce5/1     | 0.00    | 0       | 8.65    | 8446125 |
R1#
    
```

```

R2#show interface counters rate gbps
+-----+-----+-----+-----+
| Interface | Rx gbps | Rx pps | Tx gbps | Tx pps |
+-----+-----+-----+-----+
| ce3/1     | 0.00    | 0       | 8.65    | 8446188 |
| ce29/1    | 8.65    | 8446254 | 0.00    | 0       |
    
```

Interface counters after configuring loopback tx phy

R1

```
R1#show interface counters rate gbps
+-----+-----+-----+-----+
| Interface | Rx gbps | Rx pps | Tx gbps | Tx pps |
+-----+-----+-----+-----+
| ce1/1     | 8.65    | 8446147 | 8.65    | 8446319 |
| ce5/1     | 8.65    | 8446194 | 8.65    | 8446194 |
R1#
```

```
R2#show interface counters rate gbps
+-----+-----+-----+-----+
| Interface | Rx gbps | Rx pps | Tx gbps | Tx pps |
+-----+-----+-----+-----+
| ce3/1     | 0.00    | 0      | 0.00    | 0      |
R2#
```

Removing the Loopback Configuration

R1

R1#configure terminal	Enter into configure terminal mode
R1(config)#in ce5/1	Enter into interface level
R1(config-if)#no loopback	Un-configure the loopback
R1(config-if)#commit	Commit the configuration
R1(config-if)#end	Exit from the configuration mode

Loopback tx mac

R1#configure terminal	Enter into configure terminal mode
R1(config)#in ce5/1	Enter into interface level
R1(config-if)#loopback tx mac	Configure loopback tx mac
R1(config-if)#commit	Commit the configuration
R1(config-if)#end	Exit from the configuration mode

Validation

R1

```
R1#show running-config interface ce1/1
!
interface ce1/1
 switchport
 bridge-group 1
 switchport mode trunk
 switchport trunk allowed vlan add 2
!
R1#show running-config interface ce5/1
!
interface ce5/1
 switchport
 bridge-group 1
```

```

switchport mode trunk
switchport trunk allowed vlan add 2
loopback tx mac
!
R1# sh interface ce5/1
Interface ce5/1
  Flexport: Breakout Control Port (Active): Break Out disabled
  Hardware is ETH Current HW addr: 34ef.b689.e04a
  Physical:34ef.b689.e04a Logical:(not set)
  Forward Error Correction (FEC) configured is Auto (default)
  FEC status is N/A
  Port Mode is trunk
  Interface index: 5045
  Metric 1 mtu 1500 duplex-full link-speed 40g
  Debounce timer: disable
  Loopback Type: MAC
  <UP,BROADCAST,RUNNING,MULTICAST>
  VRF Binding: Not bound
  DHCP client is disabled.
  Last Flapped: 2021 Oct 23 15:57:01 (00:08:51 ago)
  Statistics last cleared: 2021 Oct 23 15:54:44 (00:11:08 ago)
  5 minute input rate 255 bits/sec, 0 packets/sec
  5 minute output rate 255 bits/sec, 0 packets/sec
RX
  unicast packets 0 multicast packets 2272 broadcast packets 0
  input packets 2272 bytes 153730
  jumbo packets 0
  undersize 0 oversize 0 CRC 0 fragments 0 jabbers 0
  input error 0
  input with dribble 0 input discard 7
  Rx pause 0
TX
  unicast packets 0 multicast packets 4333 broadcast packets 0
  output packets 4333 bytes 293304
  jumbo packets 0
  output errors 0 collision 0 deferred 0 late collision 0
  output discard 0
  Tx pause 0

```

```
R1# show interface brief
```

```

-----
Ethernet   Type           PVID  Mode           Status Reason  Speed Port  Ctl Br/Bu Loopbk
Interface                                     Ch #
-----
ce5/1      ETH            1     trunk          up      none    10g  --    Br  Yes   MAC

```

R2

```

R2#show running-config interface ce3/1
!
interface ce3/1
  switchport
  bridge-group 1
  switchport mode trunk
  switchport trunk allowed vlan add 2
!

R2#show running-config interface ce29/1
!
interface ce29/1
  switchport
  bridge-group 1
  switchport mode trunk
  switchport trunk allowed vlan add 2
!
R2#

```

Interface counters before configuring on both the devices

```
R1#show interface counters rate gbps
+-----+-----+-----+-----+
| Interface | Rx gbps | Rx pps | Tx gbps | Tx pps |
+-----+-----+-----+-----+
ce1/1      | 8.65    | 8446138 | 0.00    | 0       |
ce5/1      | 0.00    | 0       | 8.65    | 8446125 |
R1#

R2#show int counters rate gbps
+-----+-----+-----+-----+
| Interface | Rx gbps | Rx pps | Tx gbps | Tx pps |
+-----+-----+-----+-----+
ce3/1      | 0.00    | 0       | 8.65    | 8446188 |
ce29/1     | 8.65    | 8446254 | 0.00    | 0       |
R2#
```

Interface counters after configuring loopback tx phy

```
R1#show interface counters rate gbps
+-----+-----+-----+-----+
| Interface | Rx gbps | Rx pps | Tx gbps | Tx pps |
+-----+-----+-----+-----+
ce1/1      | 8.65    | 8446147 | 8.65    | 8446319 |
ce5/1      | 8.65    | 8446194 | 8.65    | 8446194 |
R1#

R2#show interface counters rate gbps
+-----+-----+-----+-----+
| Interface | Rx gbps | Rx pps | Tx gbps | Tx pps |
+-----+-----+-----+-----+
ce3/1      | 0.00    | 0       | 0.00    | 0       |
ce29/1     | 0.00    | 0       | 0.00    | 0       |
R2#
```

HARDWARE SYSTEM DIAGNOSE COMMAND REFERENCE

Chassis Management Module Commands	818
cpu-core-usage	819
debug cmm	821
locator led	822
show hardware-information	823
show system-information	839
system-load-average	844
Modifying Temperature Sensor Threshold Value	846
Overview	846
Prerequisites	846
temperature threshold	846
emer-max	848
emer-min	848
alrt-max	849
alrt-min	850
crit-max	851
crit-min	851
temperature policy (sys-reboot sys-halt none)	853
Glossary	854
Digital Diagnostic Monitoring Commands	855
clear ddm transceiver alarm	856
clear ddm transceiver alarm all	857
ddm monitor	858
ddm monitor all	859
ddm monitor interval	860
ddm raise	861
debug ddm	862
service unsupported-transceiver	863
show controller details	864
show interface all transceiver detail	865
show interface controller details	866
show interface frequency grid	868
show interface transceiver details	870
show interface transceiver detail remote	873
show interface transceiver protocol	874

show interface transceiver protocol remote	875
show interface transceiver protocol stats	876
show interface transceiver remote	877
show interface transceiver threshold violations remote	878
show supported-transceiver	879
tx-disable	880
xcvr <IFNAME> tx-disable <1-256> remote	881
xcvr <IFNAME> reset remote	882
xcvr loopback	883
wavelength	884

Chassis Management Module Commands

This chapter provides a description, syntax, and examples of CMM feature commands:

cpu-core-usage	819
debug cmm	821
locator led	822
show hardware-information	823
show system-information	839
system-load-average	844

You can retrieve the same set of information through SNMP that these commands display. This MIB is defined in **CMM-CHASSIS-MIB.txt**:

IP Infusion Inc. enterprise identifier	36673
Chassis MIB identifier	100

The MIB definition is available here:

<https://github.com/IPInfusion/OcNOS/branches>

Navigate to the directory for the version of OcNOS that you are using.



Note: Critical logs in the console are equivalent to alert traps and alert logs on the console is equivalent to critical trap in SNMP.

cpu-core-usage

Use this command to set threshold percentage values for monitoring CPU core use.

Use the `no` form of this command to set the default thresholds.

Command Syntax

```
cpu-core-usage warning <51-100> alarm <91-100>
no cpu-core-usage
```

Parameters

<51-100>

Warning threshold percentage

<91-100>

Alarm threshold percentage

Default

Check the default thresholds using the [show system-information \(page 839\)](#) command with the `cpu-load` parameter.

Command Mode

Configure mode

Applicability

This command was introduced in OcNOS version 1.3.6.

Example

```
(config)#cpu-core-usage warning 56 alarm 97
(config)#end

#show system-information cpu-load

System CPU-Load Information
=====

Uptime                : 64 Days 18 Hours 20 Minutes 12 Seconds

Load Average(1 min)   : 4.24% (Crit Thresh : 40%, Alert Thresh : 50%)
Load Average(5 min)   : 2.87% (Crit Thresh : N/A, Alert Thresh : 50%)
Load Average(15 min)  : 3.37% (Crit Thresh : N/A, Alert Thresh : 50%)

Avg CPU Usage         : 2.02%
CPU core 1 Usage      : 0.89% (Crit Thresh : 56%, Alert Thresh : 97%)
CPU core 2 Usage      : 0.00% (Crit Thresh : 56%, Alert Thresh : 97%)
CPU core 3 Usage      : 5.41% (Crit Thresh : 56%, Alert Thresh : 97%)
CPU core 4 Usage      : 2.68% (Crit Thresh : 56%, Alert Thresh : 97%)

#con t
Enter configuration commands, one per line. End with CNTL/Z.
(config)#no cpu-core-usage
(config)#end
```

```
#show system-information cpu-load

System CPU-Load Information
=====

Uptime                : 64 Days 18 Hours 21 Minutes 46 Seconds

Load Average(1 min)   : 2.44% (Crit Thresh : 40%, Alert Thresh : 50%)
Load Average(5 min)   : 2.49% (Crit Thresh : N/A, Alert Thresh : 50%)
Load Average(15 min)  : 3.27% (Crit Thresh : N/A, Alert Thresh : 50%)

Avg CPU Usage         : 1.82%
CPU core 1 Usage      : 0.00% (Crit Thresh : 50%, Alert Thresh : 90%)
CPU core 2 Usage      : 0.00% (Crit Thresh : 50%, Alert Thresh : 90%)
CPU core 3 Usage      : 4.59% (Crit Thresh : 50%, Alert Thresh : 90%)
CPU core 4 Usage      : 1.82% (Crit Thresh : 50%, Alert Thresh : 90%)
#
```

debug cmm

Use this command to enable or disable debugging for CMM.

Command Syntax

```
debug cmm  
no debug cmm
```

Parameters

None

Default

By default, CMM debugging is disabled.

Command Mode

Configure mode and Execution mode

Applicability

This command was introduced before OcNOS version 1.3.

Example

```
#configure terminal  
(config)#debug cmm  
(config)#no debug cmm
```

locator led

Use this command to turn on the locator LED.

Use the `no` form of this command to turn off the locator LED.

Command Syntax

```
locator-led on
no locator-led
```

Parameters

None

Default

By default, the locator LED is turned off.

Command Mode

Configure mode

Applicability

This command was introduced before OcNOS version 1.3.

Example

```
#configure terminal
(config)#locator-led on
(config)#no locator-led
```

show hardware-information

Use this command to display hardware information.

Command Syntax

```
show hardware-information (memory|fan|temperature|led|power (|monitoring-  
thresholds)|transceiver|system-status|all)
```

Parameters

all

Hardware details of all modules.

fan

Fan status of the boards.

led

LED status of the boards.

memory

Memory information of the boards.

power

PSU information.

monitoring-thresholds

Monitoring thresholds (if provided by hardware).

temperature

Temperature sensor information of the boards.

transceiver

Transceiver presence status and supported list of transceivers.

system-status

System fault status.

Default

None

Command Mode

Execution mode

Applicability

This command was introduced before OcNOS version 1.3. The monitoring-thresholds and system-status parameters were added in OcNOS version 5.2.

Example

```
#show hardware-information all  
-----  
                RAM INFORMATION  
-----
```

```

Total                : 15930 MB
Used                 : 1073 MB (7 %)
Free                 : 14857 MB (93 %)
Shared               : 25 MB
Buffers              : 153 MB
Total Swap           : 0 MB
Free Swap            : 0 MB
Current Processes    : 253
Total High Memory    : 0 MB
Available High Memory : 0 MB
Unit Size            : 1 Bytes
Alert Threshold      : 90 %
Critical Threshold    : 80 %
    
```

HARD DISK INFORMATION

```

Serial Number        : 99009190902000000103
Model Number         : ATP I-Temp M.2 2242
Firmware Revision    : R0822A ATP I-Temp M.2 2242
Cylinders            : 16383
Heads                 : 16
Sectors              : 250000000
Unformatted Bytes/Track : 0
Unformatted Bytes/Sector : 0
Revision No          : 1008.0
Usage Alert Threshold : 90 %
Usage Critical Threshold : 80 %
    
```

```

-----
Filesystem  Total      Used      Free      Use%
-----
/           114365    10889    103476    10%
/cfg        476      79       397       17%
/installers 4911     282     4629     6%
-----
    
```

-----System Sensors-----

```

Codes: LNR - Lower Non-Recoverable
       LCR - Lower Critical
       LNC - Lower Non-Critical
       UNC - Upper Non-Critical
       UCR - Upper Critical
       UNR - Upper Non-Recoverable
    
```

Note: For discrete sensor, thresholds and value columns are not applicable.

SENSOR	VALUE	UNITS	LNR	LCR	LNC	UNC
UCR UNR	STATE					
Temp_MAC	41.000	degrees C	na	na	na	96.000
101.000	106.000	ok				
Temp_CPU	39.000	degrees C	na	na	na	92.000
97.000	102.000	ok				
Temp_BMC	33.000	degrees C	na	na	na	80.000
85.000	89.000	ok				
Temp_10GPHY	35.000	degrees C	na	na	na	92.000
95.000	98.000	ok				
Temp_DDR4	31.000	degrees C	na	na	na	85.000
90.000	92.000	ok				
Temp_FANCARD1	29.000	degrees C	na	na	na	80.000
85.000	89.000	ok				
Temp_FANCARD2	28.000	degrees C	na	na	na	80.000
85.000	89.000	ok				
PSU0_Temp	38.000	degrees C	na	na	na	86.000
90.000	95.000	ok				
PSU1_Temp	27.000	degrees C	na	na	na	86.000
90.000	95.000	ok				

VSENSE_BMC_P12V	12.200		Volts	11.200	11.400	na	na	
12.600	12.750	ok						
VSENSE_HEATER	0.000		Volts	na	na	na	9.900	
10.000	10.100	ok						
VSENSE_BMC_P2V5	2.520		Volts	2.320	2.360	na	na	
2.640	2.680	ok						
VSENSE_1VDDR	1.010		Volts	0.900	0.940	na	na	
1.060	1.080	ok						
VSENSE_BMC_P5VT	5.040		Volts	4.680	4.740	na	na	
5.250	5.310	ok						
VSENSE_P5V_SB	5.010		Volts	4.680	4.740	na	na	
5.250	5.310	ok						
VSENSE_BMC_1.26V	1.260		Volts	1.150	1.200	na	na	
1.320	1.360	ok						
VSENSE_BMC_1.53V	1.550		Volts	1.380	1.460	na	na	
1.610	1.690	ok						
VSENSE_BMC_P3V3	3.280		Volts	3.020	3.140	na	na	
3.480	3.640	ok						
FAN_0	12400.000		RPM	2400.000	3200.000	6000.000	na	
na	na	ok						
FAN_1	12500.000		RPM	2400.000	3200.000	6000.000	na	
na	na	ok						
FAN_2	11600.000		RPM	2400.000	3200.000	6000.000	na	
na	na	ok						
FAN_3	11900.000		RPM	2400.000	3200.000	6000.000	na	
na	na	ok						
FAN_4	12200.000		RPM	2400.000	3200.000	6000.000	na	
na	na	ok						
PSU0_FAN	8190.000		RPM	3330.000	3600.000	3960.000	na	
na	na	ok						
PSU1_FAN	0.000		RPM	3330.000	3600.000	3960.000	na	
na	na	Lower Non-Recoverable						
HWM_VCORE_IN	1.000		Volts	0.910	0.940	na	na	
1.060	1.090	ok						
HWM_P1V0_VIN	1.000		Volts	0.900	0.950	na	na	
1.050	1.070	ok						
HWM_P1V2_VIN	1.180		Volts	1.110	1.140	na	na	
1.260	1.290	ok						
HWM_P1V25_VIN	1.240		Volts	1.150	1.190	na	na	
1.310	1.340	ok						
HWM_P1V8_VIN	1.770		Volts	1.660	1.710	na	na	
1.900	1.950	ok						
HWM_P3V3_VIN	3.280		Volts	3.040	3.120	na	na	
3.480	3.580	ok						
HWM_Temp_MAC	34.000		degrees C	-45.000	-42.000	-40.000	86.000	
90.000	95.000	ok						
HWM_Temp_Heater	39.000		degrees C	-45.000	-42.000	-40.000	73.000	
75.000	78.000	ok						
HWM_Temp_BMC	34.000		degrees C	-45.000	-42.000	-40.000	80.000	
85.000	89.000	ok						
HWM_Temp_CPU	33.000		degrees C	-45.000	-42.000	-40.000	86.000	
90.000	95.000	ok						
HWM_Temp_AMB	28.000		degrees C	-45.000	-42.000	-40.000	76.000	
80.000	84.000	ok						
HWM_Temp_PHY3	33.000		degrees C	-45.000	-42.000	-40.000	86.000	
90.000	95.000	ok						
CPU_PROC_HOT	0x0		discrete	na	na	na	na	
na	na	Limit Not Exceeded						
CPU_CAT_ERROR	0x0		discrete	na	na	na	na	
na	na	State Deasserted						
CPU_THERMAL_TRIP	0x0		discrete	na	na	na	na	
na	na	Limit Not Exceeded						
CPU_TO_BMC_INT	0x0		discrete	na	na	na	na	
na	na	State Deasserted						
Thermal_NMI	0x0		discrete	na	na	na	na	
na	na	Limit Not Exceeded						

```

ded
Thermal_BMC_ALRT | 0x0          | discrete | na | na | na | na |
na | na          | Limit Not Excee
ded
Thermal_PHY_ALRT | 0x0          | discrete | na | na | na | na |
na | na          | Limit Not Excee
ded
Thermal_MAC_ALRT | 0x0          | discrete | na | na | na | na |
na | na          | Limit Not Excee
ded
Thermal_DDR_ALRT | 0x0          | discrete | na | na | na | na |
na | na          | Limit Not Excee
ded
CPLD_NMI         | 0x0          | discrete | na | na | na | na |
na | na          | State Deasserte
d
VCORE_Fault      | 0x0          | discrete | na | na | na | na |
na | na          | State Deasserte
d
FAN_CARD_INT     | 0x0          | discrete | na | na | na | na |
na | na          | State Deasserte
d
BMC_LOADDEFAULT | 0x0          | discrete | na | na | na | na |
na | na          | State Deasserte
d
CPU_BOOT_Done    | 0x0          | discrete | na | na | na | na |
na | na          | Device Enabled
CPU_Presence     | 0x0          | discrete | na | na | na | na |
na | na          | Device Present
Fan0_Presence    | 0x0          | discrete | na | na | na | na |
na | na          | Device Present
Fan1_Presence    | 0x0          | discrete | na | na | na | na |
na | na          | Device Present
Fan2_Presence    | 0x0          | discrete | na | na | na | na |
na | na          | Device Present
Fan3_Presence    | 0x0          | discrete | na | na | na | na |
na | na          | Device Present
Fan4_Presence    | 0x0          | discrete | na | na | na | na |
na | na          | Device Present
CPU_POWEROK      | 0x0          | discrete | na | na | na | na |
na | na          | Device Enabled
MB_POWEROK       | 0x0          | discrete | na | na | na | na |
na | na          | Device Enabled
PSU0_Presence    | 0x0          | discrete | na | na | na | na |
na | na          | Device Present
PSU1_Presence    | 0x0          | discrete | na | na | na | na |
na | na          | Device Present
PSU0_POWEROK     | 0x0          | discrete | na | na | na | na |
na | na          | Device Enabled
PSU1_POWEROK     | 0x0          | discrete | na | na | na | na |
na | na          | Device Disabled
PSU0_INT1        | 0x0          | discrete | na | na | na | na |
na | na          | State Deasserte
d
PSU1_INT1        | 0x0          | discrete | na | na | na | na |
na | na          | State Deasserte
d
PSU0_VIN         | 118.000      | Volts    | na | na | na | na |
na | na          | ok
PSU0_VOUT        | 11.900       | Volts    | na | na | na | na |
na | na          | ok
PSU0_IIN         | 0.850        | Amps     | na | na | na | na |
na | na          | ok
PSU0_IOUT        | 2.480        | Amps     | na | na | na | na |
na | na          | ok
PSU1_VIN         | 0.000        | Volts    | na | na | na | na |
na | na          | ok
PSU1_VOUT        | 0.000        | Volts    | na | na | na | na |
na | na          | ok
PSU1_IIN         | 0.000        | Amps     | na | na | na | na |
na | na          | ok
    
```

```

PSU1_IOUT      | 0.000      | Amps      | na      | na      | na      | na      |
na             | na         | ok        |
-----
LED            COLOR            DESCRIPTION
-----
POWER          GREEN             PSU operates Normally
SYSTEM         GREEN             Normal
GNSS           GREEN             GNSS in Normal State
SYNCE         GREEN             Synchronized to external timing source
-----
                Transceiver DDM support list
-----
Type           :SFP
Vendor Name    :FINISAR CORP.
Vendor Part Number :FTLF8519P2BNL
DDM Supported  :Yes

Type           :SFP
Vendor Name    :EVERTZ
Vendor Part Number :SFP10G-TR13S
DDM Supported  :Yes

Type           :SFP
Vendor Name    :FS
Vendor Part Number :SFP-10GSR-85
DDM Supported  :Yes

Type           :SFP
Vendor Name    :FS
Vendor Part Number :SFP-10G-BX40
DDM Supported  :Yes

Type           :SFP
Vendor Name    :FS
Vendor Part Number :SFP-10G-BX
DDM Supported  :Yes

Type           :SFP
Vendor Name    :FS
Vendor Part Number :SFP-10GZRC-55
DDM Supported  :Yes

Type           :SFP
Vendor Name    :FS
Vendor Part Number :SFP-10G-BX80
DDM Supported  :Yes

Type           :SFP
Vendor Name    :JDSU
Vendor Part Number :PLRXPLSCS4322N
DDM Supported  :Yes

Type           :SFP
Vendor Name    :DELL
Vendor Part Number :CN04HG0091IAA1B
DDM Supported  :Yes

Type           :SFP
Vendor Name    :DELL
Vendor Part Number :WTRD1
DDM Supported  :Yes

Type           :SFP
Vendor Name    :FINISAR CORP.
Vendor Part Number :FTLF1318P3BTL-FC
DDM Supported  :Yes

```

```
Type : SFP
Vendor Name : DELL
Vendor Part Number : RN84N
DDM Supported : Yes

Type : SFP
Vendor Name : E.C.I.NETWORKS
Vendor Part Number : EN-SFP10G-LRi
DDM Supported : Yes

Type : SFP
Vendor Name : E.C.I.NETWORKS
Vendor Part Number : EN-SFP10G-SRi
DDM Supported : Yes

Type : SFP
Vendor Name : E.C.I.NETWORKS
Vendor Part Number : EN-SFP1G-SX
DDM Supported : Yes

Type : SFP
Vendor Name : E.C.I.NETWORKS
Vendor Part Number : EN-SFP1G-LX
DDM Supported : Yes

Type : SFP
Vendor Name : E.C.I.NETWORKS
Vendor Part Number : EN-SFP1G-EX
DDM Supported : Yes

Type : SFP
Vendor Name : E.C.I.NETWORKS
Vendor Part Number : EN-SFP1G-ZX
DDM Supported : Yes

Type : SFP
Vendor Name : E.C.I.NETWORKS
Vendor Part Number : EN-SFP10G-SR
DDM Supported : Yes

Type : SFP
Vendor Name : E.C.I.NETWORKS
Vendor Part Number : EN-SFP10G-LR
DDM Supported : Yes

Type : SFP
Vendor Name : E.C.I.NETWORKS
Vendor Part Number : EN-SFP10G-ER
DDM Supported : Yes

Type : SFP
Vendor Name : E.C.I.NETWORKS
Vendor Part Number : EN-SFPP-ER
DDM Supported : Yes

Type : SFP28
Vendor Name : E.C.I.NETWORKS
Vendor Part Number : EN-SFP28-SR
DDM Supported : Yes

Type : SFP28
Vendor Name : E.C.I.NETWORKS
Vendor Part Number : EN-SFP28-LR
DDM Supported : Yes

Type : SFP
Vendor Name : E.C.I.NETWORKS
```

```
Vendor Part Number      :EN-SFP1G-SXi
DDM Supported           :Yes

Type                    :SFP
Vendor Name             :E.C.I.NETWORKS
Vendor Part Number      :EN-SFP1G-LXi
DDM Supported           :Yes

Type                    :SFP+
Vendor Name             :OCLARO, INC.
Vendor Part Number      :TRS7081AHCPA00A
DDM Supported           :Yes

Type                    :SFP
Vendor Name             :FINISAR CORP.
Vendor Part Number      :FTLX8574D3BCL
DDM Supported           :Yes

Type                    :SFP
Vendor Name             :FINISAR CORP.
Vendor Part Number      :FCLF8522P2BTL
DDM Supported           :NO

Type                    :SFP
Vendor Name             :Edgecore
Vendor Part Number      :ET5402-AOC-10M
DDM Supported           :Yes

Type                    :SFP
Vendor Name             :Hisense
Vendor Part Number      :LTE3680P-BH+
DDM Supported           :Yes

Type                    :SFP
Vendor Name             :Hisense
Vendor Part Number      :LTF5308B-BHA+
DDM Supported           :Yes

Type                    :SFP
Vendor Name             :Hisense
Vendor Part Number      :LTF7226B-BHA+
DDM Supported           :Yes

Type                    :QSFP
Vendor Name             :AVAGO
Vendor Part Number      :AFBR-79E4Z
DDM Supported           :Yes

Type                    :QSFP
Vendor Name             :FINISAR CORP
Vendor Part Number      :FCCN410QD3C
DDM Supported           :Yes

Type                    :QSFP
Vendor Name             :FINISAR CORP
Vendor Part Number      :FTL410QE4C
DDM Supported           :Yes

Type                    :QSFP
Vendor Name             :DELL
Vendor Part Number      :119N6
DDM Supported           :Yes

Type                    :QSFP
Vendor Name             :Skylane Optics
Vendor Part Number      :QFP85P1040PD000
DDM Supported           :Yes
```

```
Type :QSFP
Vendor Name :Skylane Optics
Vendor Part Number :QFPQL010400D000
DDM Supported :Yes

Type :QSFP
Vendor Name :Skylane Optics
Vendor Part Number :QFPQL010400B000
DDM Supported :Yes

Type :QSFP
Vendor Name :Skylane Optics
Vendor Part Number :QFPQL002400D000
DDM Supported :Yes

Type :QSFP
Vendor Name :Skylane Optics
Vendor Part Number :QFP85P3040PD000
DDM Supported :Yes

Type :QSFP
Vendor Name :Skylane Optics
Vendor Part Number :QFP85P1040PB000
DDM Supported :Yes

Type :QSFP
Vendor Name :Skylane Optics
Vendor Part Number :DAPQQC504000000
DDM Supported :NO

Type :QSFP
Vendor Name :Skylane Optics
Vendor Part Number :DAPQQM014000000
DDM Supported :NO

Type :QSFP
Vendor Name :Skylane Optics
Vendor Part Number :DAPQQM034000000
DDM Supported :NO

Type :QSFP
Vendor Name :Skylane Optics
Vendor Part Number :DAPQQM054000000
DDM Supported :NO

Type :QSFP
Vendor Name :Skylane Optics
Vendor Part Number :QFP1301040PD000
DDM Supported :Yes

Type :QSFP
Vendor Name :Skylane Optics
Vendor Part Number :QFPQL040400D000
DDM Supported :Yes

Type :QSFP
Vendor Name :E.C.I.NETWORKS
Vendor Part Number :IPIENQSFP40GSR4
DDM Supported :Yes

Type :QSFP28
Vendor Name :DELL
Vendor Part Number :4WJ41
DDM Supported :Yes

Type :QSFP28
Vendor Name :FINISAR CORP
Vendor Part Number :FCBN425QE1C
```

```

DDM Supported           :Yes

Type                   :QSFP28
Vendor Name            :FINISAR CORP.
Vendor Part Number     :FTLC1151RDPL
DDM Supported           :Yes

Type                   :QSFP28
Vendor Name            :FINISAR CORP
Vendor Part Number     :FTLC9551REPM
DDM Supported           :Yes

Type                   :QSFP28
Vendor Name            :INPHI CORP
Vendor Part Number     :IN-Q2AY2
DDM Supported           :Yes

Type                   :QSFP28
Vendor Name            :FS
Vendor Part Number     :QSFP28-SR4-100G
DDM Supported           :Yes

Type                   :QSFP28
Vendor Name            :FS
Vendor Part Number     :QSFP-PC03
DDM Supported           :NO

Type                   :QSFP28
Vendor Name            :E.C.I.NETWORKS
Vendor Part Number     :EN-QSFP28-SR4
DDM Supported           :Yes

Type                   :QSFP28
Vendor Name            :E.C.I.NETWORKS
Vendor Part Number     :EN-QSFP28-LR4
DDM Supported           :Yes

Type                   :QSFP28
Vendor Name            :Skylane Optics
Vendor Part Number     :Q28QD010C07D000
DDM Supported           :Yes

Type                   :QSFP28
Vendor Name            :Skylane Optics
Vendor Part Number     :Q2885P30C0PF000
DDM Supported           :Yes

Type                   :QSFP28
Vendor Name            :Skylane Optics
Vendor Part Number     :Q28QD020C00D000
DDM Supported           :Yes

Type                   :QSFP28
Vendor Name            :Skylane Optics
Vendor Part Number     :DAOQQM01C00D000
DDM Supported           :Yes

Type                   :QSFP28
Vendor Name            :Skylane Optics
Vendor Part Number     :DAOQQM02C00D000
DDM Supported           :Yes

Type                   :QSFP28
Vendor Name            :Skylane Optics
Vendor Part Number     :DAOQQM03C00D000
DDM Supported           :Yes

Type                   :QSFP28

```

```
Vendor Name           :Skylane Optics
Vendor Part Number    :DAOQQM05C00D000
DDM Supported         :Yes

Type                  :QSFP28
Vendor Name           :Skylane Optics
Vendor Part Number    :DAOQQM07C00D000
DDM Supported         :Yes

Type                  :QSFP28
Vendor Name           :Skylane Optics
Vendor Part Number    :DAOQQM10C00D000
DDM Supported         :Yes

Type                  :QSFP28
Vendor Name           :Skylane Optics
Vendor Part Number    :DAOQQM20C00D000
DDM Supported         :Yes

Type                  :QSFP28
Vendor Name           :Skylane Optics
Vendor Part Number    :DAOQQM30C00D000
DDM Supported         :Yes

Type                  :QSFP28
Vendor Name           :Skylane Optics
Vendor Part Number    :DAOQQP10C00D000
DDM Supported         :Yes

Type                  :QSFP28
Vendor Name           :Skylane Optics
Vendor Part Number    :Q2885P10C0PF000
DDM Supported         :Yes

Type                  :QSFP28
Vendor Name           :Skylane Optics
Vendor Part Number    :Q28QD040C00F000
DDM Supported         :Yes

Type                  :QSFP28
Vendor Name           :Skylane Optics
Vendor Part Number    :Q28QD010C00D000
DDM Supported         :Yes

Type                  :QSFP28
Vendor Name           :Skylane Optics
Vendor Part Number    :Q28QD010C04D000
DDM Supported         :Yes

Type                  :QSFP28
Vendor Name           :Skylane Optics
Vendor Part Number    :Q28QD040C05F000
DDM Supported         :Yes

Type                  :QSFP28
Vendor Name           :Skylane Optics
Vendor Part Number    :Q28QD040C05D000
DDM Supported         :Yes

Type                  :QSFP28
Vendor Name           :Skylane Optics
Vendor Part Number    :DAPQQM03C000000
DDM Supported         :NO

Type                  :QSFP28
Vendor Name           :Skylane Optics
Vendor Part Number    :DAPQQM01C000000
DDM Supported         :NO
```

```
Type :QSFP28
Vendor Name :Skylane Optics
Vendor Part Number :DAPQQM02C000000
DDM Supported :NO
```

```
Type :QSFP28
Vendor Name :Skylane Optics
Vendor Part Number :DAPQQM05C000000
DDM Supported :NO
```

```
Type :QSFP28
Vendor Name :Skylane Optics
Vendor Part Number :DAPQQC50C000000
DDM Supported :NO
```

```
Type :QSFP28
Vendor Name :Skylane Optics
Vendor Part Number :Q28QL002C00F000
DDM Supported :Yes
```

```
Type :QSFP28
Vendor Name :Skylane Optics
Vendor Part Number :Q2C31002C00F000
DDM Supported :Yes
```

```
Type :QSFP28
Vendor Name :Skylane Optics
Vendor Part Number :Q2C31P50C00F000
DDM Supported :Yes
```

```
Type :QSFP28
Vendor Name :Skylane Optics
Vendor Part Number :Q2B85M70C00D000
DDM Supported :Yes
```

```
Type :QSFP28
Vendor Name :Skylane Optics
Vendor Part Number :Q28QD080C05F000
DDM Supported :Yes
```

```
Type :QSFP28
Vendor Name :E.C.I.NETWORKS
Vendor Part Number :IPIENQSFP28SR4
DDM Supported :Yes
```

```
TX : Transmit status
RX-Los : Receive status
RESET : Normal (Out of reset), Reset (In reset)
POWER : Power level Low/High
- : NotApplicable
```

SFP:[0-27]

PORT	PRESENCE	Tx	Rx-Los
0	Not Present	Off	-
1	Not Present	Off	-
2	Not Present	Off	-
3	Present	On	-
4	Present	On	-
5	Not Present	Off	-
6	Present	On	-
7	Present	On	Off
8	Not Present	Off	-
9	Not Present	Off	-
10	Present	On	-

```

11 Present On -
12 Present On On
13 Not Present Off -
14 Not Present Off -
15 Present On Off
16 Present On Off
17 Not Present Off -
18 Present On -
19 Present On Off
20 Present On Off
21 Not Present Off -
22 Present On -
23 Present On -
24 Not Present Off -
25 Not Present Off -
26 Not Present Off -
27 Not Present Off -

QSFP: [0-1]
-----
PORT PRESENCE RESET POWER LANE
-----
1 2 3 4
-----
0 Not Present Reset Low Tx off off off off
Rx-Los Off Off Off Off
Tx-Los Off Off Off Off
1 Present Normal High Tx on on on on
Rx-Los Off Off Off Off
Tx-Los Off Off Off Off

System Over all status : Normal

-----
Components status
-----
CPU : Normal
RAM : Normal
DISK : Normal
SOFTWARE : Normal

Codes: H-Mi- High Minor H-Ma- High Major L-Mi- Low Minor L-Ma- Low Major

Component Fault Timestamp Thresh Violation-Status
-----

```

Table 56 explains the show command output fields.

Table 56. show hardware-information all output

Field	Description
Ram Information	Used memory, free memory, shared, buffers, total swap, and free swap memory.
Hard Disk Information	Hard drive serial number, model, firmware revision, cylinders, heads, and sectors, as well as revision number and total size.
Fans	Fan tray numbers, numbers of fans per tray, and their speed in RPM.
Board Temp Sensors Temperature	Sensor type, current temperature, and operating range.
BCM Chip Internal Temperature	Broadcom chip current internal temperature, Operating range and average temperature.

Table 56. show hardware-information all output (continued)

Field	Description
System Power Information	System power Information. Shows Voltage on all rails, and whether the power is up or has failed.
PSU	Main power supply statistics: Volts in, volts out, current in and out amperes, power in and out in watts, temperature of each power supply, and fan speed in RPM.
LED	What the LEDs represent, what state the LEDs mean, and a description of what the LEDs current color means.
Transceiver DDM support list	Transceivers: type, vendor name, part number, and whether Digital Diagnostic Monitoring (DDM) is supported.
Port Number	Port numbers, port type (SFP, QSFP, etc) and whether a transceiver is in the port.

```
#show hardware-information power
-----
Hardware Thresholds
-----
PSU1 [Input Voltage]
-----
Shutdown(O)   : 62.00 Volts
Resume(O)     : 60.00 Volts
Shutdown(U)   : 38.00 Volts
Resume(U)     : 36.00 Volts
PSU1 [Temperature 1]
-----
Shutdown(O)   : 85.00 Celsius
Resume(O)     : 80.00 Celsius
PSU2 [Input Voltage]
-----
Shutdown(O)   : 62.00 Volts
Resume(O)     : 60.00 Volts
Shutdown(U)   : 38.00 Volts
Resume(U)     : 36.00 Volts

-----
System Power Information
-----
CMM_PS1_12V_PG           : FAIL
CMM_PS2_12V_PG           : GOOD
CMM_PS1_AC_ALERT        : FAIL
CMM_PS2_AC_ALERT        : GOOD

Codes:   * Not Supported by device   NA Not Applicable   O Over   U Under

PSU      VOLT-IN  VOLT-OUT  CURR-IN  CURR-OUT  PWR-IN   PWR-OUT  TEMP-1   TEMP-
2        FAN-1    FAN-2    PWR_
OUT_MAX
(Volt)   (Volt)   (Ampere) (Ampere) (Watt)   (Watt)   (Celsius) (Celsius)
(Rpm)   (Rpm)
-----
2        225.00   12.00    1.47     25.50    330.00   306.00   27.00    31.00    45
12       NA*      NA*
#
```

Table 57 explains the show hardware-information power command output fields.

Table 57. show hardware-information power output fields

Field	Description
PSU Input Voltage	Shutdown and resume over and under voltages
PSU Temperature	Shutdown and resume over temperatures
System Power Information	Overall status of each PSU
PSU	Power supply unit identifier
VOLT-IN	Input voltage
VOLT-OUT	Output voltage
CURR-IN	Input current (ampere)
CURR-OUT	Output current (ampere)
PWR-IN	Input power (watts)
PWR-OUT	Output power (watts)
TEMP-1	Temperature (Celsius)
TEMP-2	Temperature (Celsius)
FAN-1	FAN 1 RPM
FAN-2	FAN 2 RPM
PWR_OUT_MAX	Power out maximum

```
#show hardware-information power monitoring-thresholds
```

```
-----  
      Input Voltage [PSU1]
```

```
-----  
High Alarm      : 60.00 Volts  
Low Alarm       : 40.00 Volts  
High Warning    : 58.00 Volts  
Low Warning     : 42.00 Volts  
-----
```

```
      Temperature 1 [PSU1]
```

```
-----  
High Alarm      : 75.00 Celsius  
Low Alarm       : -10.00 Celsius  
High Warning    : 73.00 Celsius  
Low Warning     : -8.00 Celsius  
-----
```

```
      Input Voltage [PSU2]
```

```
-----  
High Alarm      : 60.00 Volts  
Low Alarm       : 40.00 Volts  
High Warning    : 58.00 Volts  
Low Warning     : 42.00 Volts  
-----
```

[Table 58](#) explains the show hardware-information powermonitoring-thresholds command output fields.

Table 58. show hardware-information power monitoring-thresholds output fields

Field	Description
Input Voltage	Voltages for high alarm, low alarm, high warning, and low warning thresholds
Temperature	Temperatures for high alarm, low alarm, high warning, and low warning thresholds

```
#show hardware-information system-status

System Over all status   : Normal

-----

Components status

-----

CPU       : Normal
RAM       : Normal
DISK      : Normal
FAN       : Normal
POWER     : Normal
SOFTWARE  : Normal

Codes: H-Mi- High Minor H-Ma- High Major L-Mi- Low Minor L-Ma- Low Major

Component  Fault  Timestamp                Thresh  Violation-Status
-----  -
DISK      H-Mi   12-02-2021 18:39:32  > 80.00  84.00%
POWER     L-Mi   12-02-2021 18:43:46  < 42.00  Psu [1] of VOLT-IN is 42.00
          12-02-2021 18:42:35                Psu [2] of VOLT-IN is 42.00
          L-Ma   12-02-2021 18:41:44  < 40.00  Psu [1] of VOLT-IN is 24.00
          H-Ma   12-02-2021 18:44:27  > 75.00  Psu [1] of TEMP1 is 80.00

#
```

[Table 59](#) explains the show hardware-information system-status command output fields.

Table 59. show hardware-information system-status output fields

Field	Description
System Over all status	Self explanatory
Components status	Status of CPU, RAM, disk, fan, power, and software
Component	Component name
Fault	Type of fault: H-Mi- High Minor

Table 59. show hardware-information system-status output fields (continued)

Field	Description
	H-Ma- High Major L-Mi- Low Minor L-Ma- Low Major
Timestamp	Date and time of the fault
Thresh	Threshold limit
Violation-Status	Explanation of violation

show system-information

Use this command to display system information.

Command Syntax

```
show system-information (all|fan|psu|os|cpu|bios|cpu-load|board-info)
```

Parameter

all

System information of all modules.

bios

BIOS information.

board-info

Board EEPROM details.

cpu

Processor information.

cpu-load

CPU load information.

fan

Fan Field Replaceable Units (FRU) EEPROM information.

os

OS and Kernel version information.

psu

Power Supply Field Replaceable Units (FRU) EEPROM information.

Default

None

Command Mode

Execution mode

Applicability

This command was introduced before OcNOS version 1.3.

Example

```
#show system-information psu
System PSU FRU Information
=====
PSU 2 Country of Origin      : CN
PSU 2 PPID Part Number     : 0T9FNW
PSU 2 PPID Part Number Rev  : A00
PSU 2 Manufacturer ID      : 28298
PSU 2 Date Code            : 52R
PSU 2 Serial Number        : 0298
```

```

PSU 2 Part Number           : OT9FNW
PSU 2 Part Number Revision  : A00
PSU 2 Number of Fans in the tray : 1
PSU 2 Type                  : AC Normal
PSU 2 Service Tag           : AEIOU

```

The following tables explain the show command output fields.

Table 60. show system-information topics

Topic	Description
all	Show all topics of system information.
bios	Display BIOS information.
board-info	Display information related to the board.
cpu	Displays Central Processing Unit information
cpu-load	Displays the load on the system's CPU.
fan	Displays fan information contain in the EEPROM.
os	Displays information regarding the host operating system
psu	Displays information regarding Field Replaceable Units (FRU).

Table 61. Show fan topic displays

System Fan FRU Information	Description
Fan Tray "# PPID Part Number	The vendor's part number for the fan.
Fan Tray Serial Number	As stated
Service Tag	The Service Tag can help identify your device for on-line support and upgrading drivers
Vendor Name	As stated

Table 62. Show system BIOS information

BIOS Information	Description
# dmidecode	The dmidecode is a tool for dumping a computer's DMI table contents in a human-readable format. This table contains a description of the system's hardware components, as well as other useful pieces of information such as serial numbers and BIOS revisions.
SMBIOS	The System Management BIOS (SMBIOS) defines data structures (and access methods) that can be used to read management information produced by the BIOS of a computer. Also, it is involved with the DMI Address –
Handle 0x0000, DMI type 0, 24 bytes	Handle of the Desktop Management Interface (DMI) and the DMI type, where type value identifies what the DMI contains. DMI = 0 indicates the following information is specific to BIOS properties, and is 24 bytes long.
BIOS Physical Information	<ul style="list-style-type: none"> Vendor – The manufacture of the BIOS.

Table 62. Show system BIOS information (continued)

BIOS Information	Description
	<ul style="list-style-type: none"> • Version – The Version number. • Release Date – as stated. • Address – starting address (in memory) of the BIOS.
Characteristics	<ul style="list-style-type: none"> • Is PCI supported. • Is BIOS upgradeable. • Is boot from a CD supported. • Is selectable boot devices supported. • Is BIOS ROM socketed. • Is Enhanced Disk Drive (EDD) vectoring supported. • Is 5.25"/1.2 MB floppy services supported (int 13h) • Is 3.5"/720 kB floppy services supported (int 13h) • Is 3.5"/2.88 MB floppy services supported (int 13h) • Is Print screen service supported (int 5h) • Is 8042 keyboard services supported (int 9h) • Is Serial services supported (int 14h) • Is Printer services supported (int 17h) • Is Advanced Configuration and Power Interface (ACPI) supported • Is USB legacy supported • Is BIOS boot specification supported • Is Targeted content distribution supported • Is Unified Extensible Firmware Interface (UEFI) supported
BIOS Revision	The BIOS revision number.
Handle 0x0043, DMI type 13, 22 bytes	Handle of the Desktop Management Interface (DMI) and the DMI type, where type value identifies what the DMI contains. DMI = 13 indicates the following information is specific to BIOS language information, and is 22 bytes long.
BIOS Language Information	<ul style="list-style-type: none"> • Language Description Format – A term that describes the number of bits used to represent the BIOS Language information parameters. • Installable Languages – The number of languages that can be used by the BIOS at any time. • Currently Installed Language – United States English (or Latin-1) as described by the ISO standard, en US iso8859-1.

Table 63. Show CPU information

System CPU Information	Description
processor	The processor number of each CPU
model name	Details about each CPU. For example, Intel(R) Atom(TM) CPU C2538 @ 2.40GHz.

Table 64. Show system CPU load information

Load Information	Description
Uptime	As stated in days, hours, minutes, and seconds.
Load Average for past 1min	As stated in percent.
Load Average for past 5 min	As stated in percent.
Load Average for past 15 min	As stated in percent.
CPU Usage at this instant	As stated in percent.
Max threshold for CPU-usage	As stated in percent.

Table 65. Show system board information

System Information	Description
Product Name	Model number of the device.
Serial Number	As stated
Base MAC Address	As stated
Manufacture Date	As state
Platform Name	The platform on which the product is based.
ONIE Version	The version of the Open Network Install Environment (ONIE).
MAC addresses	Number of MAC addresses related to the device.
Manufacture	As stated
Country Code	The code that represents the country of manufacture. For example, US = United States, TW = Taiwan, and so on.
Diag Version	As stated
CRC-32	Cyclic Redundancy Check value.
Switch Chip Revision	As stated
MAIN BOARD REVISION	As stated
CPU CPLD VERSION	The version of the Complex Programmable Logic Device (CPLD) use by the CPU.
SW CPLD VERSION	The version of the Complex Programmable Logic Device (CPLD) use by the switch.
MAIN BOARD TYPE	An identifying string for the main board.
CPU BOARD ID	An identifying string for the CPU board.
CPU BOARD VERSION	As stated
SW BOARD ID	NA
SW BOARD VERSION	As stated
VCC 5V	The state of the VCC 5V power rail (Enabled \ Disabled)
MAC 1V	The state of the MAC 1V power rail Enabled \ Disabled
VCC 1.8V	The state of the VCC 1.8V power rail (Enabled \ Disabled)

Table 65. Show system board information (continued)

System Information	Description
MAC AVS 1V	The state of the MAC AVS 1V power rail (Enabled \ Disabled)
HOT SWAP1	Enabled \ Disabled
HOT SWAP2	Enabled \ Disabled

Table 66. Show host system details

Host Information	Description
OS Distribution	The operating system on which the device is to run.
Kernel Version	A string that identifies the operating kernel.

system-load-average

Use this command to set threshold percentage values for monitoring the system load average for the last 1 minute, 5 minutes, and 15 minutes.

Use the **no** form of this command to set the default thresholds.

Command Syntax

```
system-load-average (1min warning <41-100> alarm <51-100> 5min alarm <51-100> 15min alarm <51-100>)  
no system-load-average
```

Parameters

1min warning

Load average for last 1 minute

<41-100>

Warning threshold in percent

alarm

Alarm

<51-100>

Alarm threshold in percent

5min alarm

Load average for last 5 minutes

<51-100>

Alarm threshold in percent

15min alarm

Load average for last 15 minutes

<51-100>

Alarm threshold in percent

Default

Check the default thresholds using the [show system-information \(page 839\)](#) command with the **cpu-load** parameter.

Command Mode

Configure mode

Applicability

This command was introduced in OcNOS version 1.3.6.

Example

```
(config)#system-load-average 1min warning 45 alarm 55 5min alarm 65 15min alarm 75  
(config)#end  
  
#show system-information cpu-load
```

```
System CPU-Load Information
=====
```

```
Uptime                : 64 Days 17 Hours 56 Minutes 22 Seconds

Load Average(1 min)   : 5.74% (Crit Thresh : 45%, Alert Thresh : 55%)
Load Average(5 min)   : 3.71% (Crit Thresh : N/A, Alert Thresh : 65%)
Load Average(15 min)  : 3.21% (Crit Thresh : N/A, Alert Thresh : 75%)

Avg CPU Usage         : 4.67%
CPU core 1 Usage      : 4.42% (Crit Thresh : 50%, Alert Thresh : 90%)
CPU core 2 Usage      : 2.68% (Crit Thresh : 50%, Alert Thresh : 90%)
CPU core 3 Usage      : 6.19% (Crit Thresh : 50%, Alert Thresh : 90%)
CPU core 4 Usage      : 5.36% (Crit Thresh : 50%, Alert Thresh : 90%)
```

```
#con t
Enter configuration commands, one per line. End with CNTL/Z.
(config)#no system-load-average
(config)#end
```

```
#show system-information cpu-load
```

```
System CPU-Load Information
=====
```

```
Uptime                : 64 Days 18 Hours 16 Minutes 34 Seconds

Load Average(1 min)   : 0.63% (Crit Thresh : 40%, Alert Thresh : 50%)
Load Average(5 min)   : 1.90% (Crit Thresh : N/A, Alert Thresh : 50%)
Load Average(15 min)  : 3.11% (Crit Thresh : N/A, Alert Thresh : 50%)

Avg CPU Usage         : 2.07%
CPU core 1 Usage      : 1.83% (Crit Thresh : 50%, Alert Thresh : 90%)
CPU core 2 Usage      : 0.00% (Crit Thresh : 50%, Alert Thresh : 90%)
CPU core 3 Usage      : 6.36% (Crit Thresh : 50%, Alert Thresh : 90%)
CPU core 4 Usage      : 0.93% (Crit Thresh : 50%, Alert Thresh : 90%)
```

Modifying Temperature Sensor Threshold Value

Overview

Typically, the temperature policies of hardware equipments are predefined and enforced through hardware or software by hardware vendors. However, for hardwares without baseboard management controller (BMC) built-in, the temperature policies are managed through software from Network Operating System (NOS) vendors.

OcNOS is enhanced to manage the hardware temperature through new commands line interfaces from 6.5.3 release. These newly defined software policy based temperature control CLIs are compliance to the hardware vendor standards. However, to satisfy some users who wants to modify the present threshold values at their convenience can do so. They are willing to take risks by stretching the predefined threshold values by the hardware vendor.

However, IPI strongly recommends not to modify the default policy as it may lead to hardware component failure.

Feature Characteristics

Using this feature users can control both or any one of them based on the requirement.

- the threshold values for each severity level and temperature sensor,
- and
- the system action upon a violation to either HALT, REBOOT or NONE.

The hardware's default policy is applied if no user configuration exists or is removed.

A warning message alerts users if they set thresholds beyond the “Emergency Max/Min” values or configure the policy to “none,” emphasizing the potential risks involved.

These commands are applicable only to EdgeCore and UfiSpace hardwares without BMC built-in.

Benefits

This feature enables an exceptional control for users. With the current default hardware temperature policy, when OcNOS detects the temperature threshold value violation, it shuts down the system to prevent hardware damage. Some customers have deployed the units in far remote areas, and whenever this happens it becomes troublesome for them to switch the units back ON. In such exceptional cases, enables the user to modify the predefined thresholds value and change the behaviors of the system to either REBOOT or NONE instead of HALT.

Prerequisites

The hardware should be up and active.

temperature threshold

Use this command to set temperature threshold for each severity level of the sensor.

Use the `no` form of this command to set the default thresholds.

Command Syntax

```
temperature threshold <1-15>
```

```
no temperature threshold <1-15>
```

Parameters

<1-15>

Specifies the sensor number to be configured. Refer to [temperature threshold \(page 846\)](#) temperature CLI command section to view the available sensor types.

Default

Check the default temperature thresholds using the `show hardware-information temperature` command.

Command Mode

Configuration Mode

Applicability

Introduced in OcNOS version 6.5.3.

Example

To configure the hardware device temperature threshold value, execute:

```
OcNOS(config)#temperature threshold 1
OcNOS(config-temperature-threshold)#
```

The mode changes to temperature threshold mode.

```
 #(config-temperature-threshold)#emer-min 5
 #(config-temperature-threshold)#commit
```

To remove the configuration, execute:

```
OcNOS(config)#no temperature threshold 1
```

To view the current hardware temperature, execute

```
#show running-config |include temperature | emer-min
temperature threshold 1
emer-min 5
```

```
OcNOS#show hardware-information temperature
Board Temp Sensors Temperature in Degree C
```

```
-----
-
SENSOR TYPE                                CURR  EMER  ALRT CRIT CRIT ALRT EMER  MIN-TEMP  MAX-TEMP  AVG-TEMP
TEMP  MIN   MIN  MIN  MAX  MAX  MAX  (Monitored since 72 hour,00
min)
-----
-
[ 1] CPU                                    42.00  5    10  14  60  65  70    37.50    44.00    40.40
[ 2] Mainboard Front middle                37.50  0    10  14  60  65  70    33.50    39.50    36.41
[ 3] Mainboard Rear Left                   35.00  0    10  14  60  65  70    32.00    36.50    33.92
[ 4] Mainboard Right                       33.00  0    10  14  60  65  70    28.50    34.50    31.59
[ 5] BCM Chip                              54.20  0    10  14  75  80  95    48.90    56.90    52.25
[ 6] Intel CPU Core ID 2                   54.00  0    3    6   66  71  91    47.00    57.00    52.06
[ 7] Intel CPU Core ID 6                   52.00  0    3    6   66  71  91    46.00    56.00    50.38
[ 8] Intel CPU Core ID 8                   53.00  0    3    6   66  71  91    46.00    55.00    50.17
[ 9] Intel CPU Core ID 12                  54.00  0    3    6   66  71  91    46.00    57.00    51.23
```

```
BCM Chip Internal Temperature
```

```
-----
TEMP MONITOR    CURRENT TEMP    PEAK TEMP
(Degree C)      (Degree C)
-----
```

1	49.40	52.10
2	49.90	52.10
3	52.60	55.30
4	49.90	52.10
5	54.20	55.30
6	53.10	55.30
7	52.60	54.70
8	52.10	54.70
9	49.90	53.10
10	49.90	52.60

emer-max

Use this command to configure hardware emergency temperature threshold maximum value.

Use `no` parameter to remove the replace the configured emergency temperature maximum value to default threshold value.

Command Syntax

```
emer-max <-50-150>  
no emer-max
```

Parameters

<-50-150>

Specifies the emergency temperature-threshold maximum range value.

Default

None

Command Mode

Temperature-threshold

Applicability

Introduced in OcNOS version 6.5.3.

Example

To configure the hardware device temperature threshold value, execute:

```
OcNOS(config)#temperature threshold 2  
OcNOS(config-temperature-threshold)#
```

The mode changes, to configure the emergency temperature sensor's maximum threshold value, execute:

```
OcNOS(config-temperature-threshold)#emer-max 78
```

The hardware threshold is over-written with user configured threshold. To unconfigure the user defined threshold values, execute:

```
OcNOS(config-temperature-threshold)#no emer-max
```

emer-min

Use this command to configure hardware emergency temperature threshold minimum value.

Use `no` parameter to remove the replace the configured emergency temperature minimum value to default threshold value.

Command Syntax

```
emer-min <-50-150>  
no emer-min
```

Parameters

<-50-150>

Specifies the emergency temperature-threshold minimum range value.

Default

None

Command Mode

Temperature-threshold

Applicability

Introduced in OcNOS version 6.5.3.

Example

To configure the hardware device temperature threshold value, execute:

```
OcNOS(config)#temperature threshold 2  
OcNOS(config-temperature-threshold)#
```

The mode changes, to configure the emergency temperature sensor's minimum threshold value, execute:

```
OcNOS(config-temperature-threshold)#emer-min 1
```

The hardware threshold is over-written with user configured threshold. To unconfigure the user defined threshold values, execute:

```
OcNOS(config-temperature-threshold)#no emer-min
```

alrt-max

Use this command to configure hardware alert temperature threshold maximum value.

Use `no` parameter to remove the replace the configured alert temperature maximum value to default threshold value.

Command Syntax

```
alrt-max <-50-150>  
no alrt-max
```

Parameters

<-50-150>

Specifies the alert Temperature-threshold maximum range value.

Default

None

Command Mode

Temperature-threshold

Applicability

Introduced in OcNOS version 6.5.3.

Example

To configure the hardware device temperature threshold value, execute:

```
OcNOS(config)#temperature threshold 2
OcNOS(config-temperature-threshold)#
```

The mode changes, to configure the alert temperature sensor's maximum threshold value, execute:

```
OcNOS(config-temperature-threshold)#alrt-max 73
```

The hardware threshold is over-written with user configured threshold. To unconfigure the user defined threshold values, execute:

```
OcNOS(config-temperature-threshold)#no alrt-max
```

alrt-min

Use this command to configure hardware alert temperature threshold minimum value.

Use **no** parameter to remove the replace the configured alert temperature minimum value to default threshold value.

Command Syntax

```
alrt-min <-50-150>
no alrt-min
```

Parameters**<-50-150>**

Specifies the alert Temperature-threshold minimum range value.

Default

None

Command Mode

Temperature-threshold

Applicability

Introduced in OcNOS version 6.5.3.

Example

To configure the hardware device temperature threshold value, execute:

```
OcNOS(config)#temperature threshold 2
```

```
OcNOS (config-temperature-threshold) #
```

The mode changes, to configure the alert temperature sensor's minimum threshold value, execute:

```
OcNOS (config-temperature-threshold) #alrt-min 11
```

The hardware threshold is over-written with user configured threshold. To unconfigure the user defined threshold values, execute:

```
OcNOS (config-temperature-threshold) #no alrt-min
```

crit-max

Use this command to configure hardware critical temperature threshold maximum value.

Use **no** parameter to remove the replace the configured critical temperature maximum value to default threshold value.

Command Syntax

```
crit-max <-50-150>  
no crit-max
```

Parameters

<-50-150>

Specifies the critical temperature-threshold maximum range value.

Default

None

Command Mode

Temperature-threshold

Applicability

Introduced in OcNOS version 6.5.3.

Example

To configure the hardware device temperature threshold value, execute:

```
OcNOS (config) #temperature threshold 2  
OcNOS (config-temperature-threshold) #
```

The mode changes, to configure the critical temperature sensor's maximum threshold value, execute:

```
OcNOS (config-temperature-threshold) #crit-max 69
```

The hardware threshold is over-written with user configured threshold. To unconfigure the user defined threshold values, execute:

```
OcNOS (config-temperature-threshold) #no crit-max
```

crit-min

Use this command to configure hardware critical temperature threshold minimum value.

Use **no** parameter to remove the replace the configured critical temperature minimum value to default threshold value.

Command Syntax

```
crit-min <-50-150>  
no crit-min
```

Parameters

<-50-150>

Specifies the critical Temperature-threshold minimum range value.

Default

None

Command Mode

Temperature-threshold

Applicability

Introduced in OcNOS version 6.5.3.

Example

To configure the hardware device temperature threshold value, execute:

```
OcNOS(config)#temperature threshold 2  
OcNOS(config-temperature-threshold)#
```

The mode changes, to configure the critical temperature sensor's minimum threshold value, execute:

```
OcNOS(config-temperature-threshold)#crit-min 15
```

The hardware threshold is over-written with user configured threshold. To unconfigure the user defined threshold values, execute:

```
OcNOS(config-temperature-threshold)#no crit-min
```

temperature policy (sys-reboot | sys-halt | none)

Use this command to configure the temperature policy.

Use **no** parameter to remove the configured temperature policy.

Command Syntax

```
temperature policy (sys-reboot | sys-halt | none)  
no temperature policy
```

Parameters

none	None
sys-halt	System halt
sys-reboot	System reboot

Default

None

Command Mode

Configuration Mode

Applicability

Introduced in OcNOS version 6.5.3.

Example

Execute the following command to apply the temperature policy and reboot the system.

```
(config)#temperature policy sys-reboot
(config)#commit
(config)#no temperature policy
(config)#commit
```

temperature policy (sys-reboot | sys-halt | none)

Use this command to configure the temperature policy.

Use **no** parameter to remove the configured temperature policy.

Command Syntax

```
temperature policy (sys-reboot | sys-halt | none)
no temperature policy
```

Parameters**1000-60000**

Threshold in milliseconds.

none

none

sys-halt

System halt

sys-reboot

System reboot

Default

None

Command Mode

Configure mode

Applicability

This command was introduced in OcNOS version 6.5.3.

Examples

Execute the following command to apply the temperature policy and reboot the system.

```
(config)#temperature policy sys-reboot
(config)#commit
(config)#no temperature policy
(config)#commit
```

Glossary

Key Terms/Acronym	Description
BMC	Baseboard Management Controller
NOS	Network Operating System

Digital Diagnostic Monitoring Commands

This chapter is a reference for Digital Diagnostic Monitoring (DDM) commands:

clear ddm transceiver alarm	856
clear ddm transceiver alarm all	857
ddm monitor	858
ddm monitor all	859
ddm monitor interval	860
ddm raise	861
debug ddm	862
service unsupported-transceiver	863
show controller details	864
show interface all transceiver detail	865
show interface controller details	866
show interface frequency grid	868
show interface transceiver details	870
show interface transceiver detail remote	873
show interface transceiver protocol	874
show interface transceiver protocol remote	875
show interface transceiver protocol stats	876
show interface transceiver remote	877
show interface transceiver threshold violations remote	878
show supported-transceiver	879
tx-disable	880
xcvr <IFNAME> tx-disable <1-256> remote	881
xcvr <IFNAME> reset remote	882
xcvr loopback	883
wavelength	884

clear ddm transceiver alarm

Use this command to clear the transceiver alarm in the DDM monitor interface.

Command Syntax

```
clear ddm transceiver alarm
```

Parameters

None

Default

None

Command Mode

Interface mode

Applicability

This command was introduced before OcNOS version 1.3.

Example

```
#configure terminal
(config)#interface xe1
(config-if)#clear ddm transceiver alarm
(config-if)#exit
```

clear ddm transceiver alarm all

Use this command to clear the transceiver DDM alarm for all interface.

Command Syntax

```
clear ddm transceiver alarm all
```

Parameters

None

Default

None

Command Mode

Execution mode

Applicability

This command was introduced before OcNOS version 1.3.

Example

```
# clear ddm transceiver alarm all
```

ddm monitor

Use this command to enable or disable DDM monitoring for interfaces which have a supported transceiver.

Use the `no` form of this command to remove DDM monitoring for all transceivers.

Command Syntax

```
ddm monitor (disable|enable)
no ddm monitor
```

Parameters

enable

Enable DDM monitoring.

disable

Disable DDM monitoring.

Default

By default, DDM monitoring is disabled.

Command Mode

Interface mode

Applicability

This command was introduced before OcNOS version 1.3.

Example

```
#configure terminal
(config)#interface xe1
(config-if)#ddm monitor enable
(config-if)#ddm monitor disable
(config-if)#exit
(config)#interface xe1
(config-if)#no ddm monitor
(config-if)#exit
```

ddm monitor all

Use this command to enable DDM monitoring for all transceiver.s

Use the `no` form of this command to disable DDM monitoring for all transceivers.

Command Syntax

```
ddm monitor all
no ddm monitor all
```

Parameters

None

Default

By default, DDM monitoring is disabled.

Command Mode

Configure mode

Applicability

This command was introduced before OcNOS version 1.3.

Example

```
#configure terminal
(config)#ddm monitor all
(config)#no ddm monitor all
```

ddm monitor interval

Use this command to set the monitoring interval for the transceiver.

Use no form with this command to set the monitoring interval to its default.

Command Syntax

```
ddm monitor interval <60-3600>  
no ddm monitor interval
```

Parameters

<60-3600>

Interval period in seconds.

Default

The default monitoring interval is 60 seconds.

Command Mode

Configure mode

Applicability

This command was introduced before OcNOS version 1.3.

Example

```
#configure terminal  
(config)#ddm monitor interval 60
```

ddm raise

Use this command to raise a false alarm on the remote smart SFP.

Use this command to clear the false alarm on the remote smart SFP.

Command Syntax

```
ddm raise false alarm IFNAME (((temperature|voltage|voltage2|current|rxpower|txpower|frequency-  
error|wavelength-error|snr|resisi|leveltrans|tecurrent|prefecber|  
uncorrectedber|lasertemp) VALUE)| tec-fault) (remote|)  
no ddm raise false alarm IFNAME (temperature|voltage|voltage2|current|rxpower|txpower|frequency-  
error|wavelength-error|tec-fault|snr|resisi|leveltrans|tecurrent|prefecber|  
uncorrectedber|lasertemp) (remote|)
```

Parameters

None

Default

By default, the debug command is not configured.

Command Mode

Configuration mode Configure mode

Applicability

This command was introduced before OcNOS version 6.2.0.

Example

The following command displays detailed information ddm raise.

```
OcNOS(config)#conf t  
OcNOS(config)#ddm raise false alarm xe1 temperature +95.00 remote  
OcNOS(config)#ddm raise false alarm xe1 voltage +3.50 remote
```

debug ddm

Use this command to enable or disable debugging for DDM.

Command Syntax

```
debug ddm  
no debug ddm
```

Parameters

None

Default

By default, debug command is not configured.

Command Mode

Configure mode

Applicability

This command was introduced before OcNOS version 1.3.

Example

```
#configure terminal  
(config)#debug ddm  
(config)#no debug ddm
```

service unsupported-transceiver

Use this command to allow an unsupported transceiver to be enabled for DDM monitoring.

Use the `no` form of this command to disable DDM on an unsupported transceiver.

Command Syntax

```
service unsupported-transceiver
no service unsupported-transceiver
```

Parameters

None

Default

By default, DDM on an unsupported transceiver is disabled.

Command Mode

Configuration mode

Applicability

This command was introduced before OcNOS version 1.3.

Example

```
#configure terminal
(config)#service unsupported-transceiver
(config)#no service unsupported-transceiver
```

show controller details

Use this command to display the EEPROM details of transceivers.

Command Syntax

```
show interface (IFNAME|) controllers
```

Parameters

IFNAME

Interface name. If not specified, this command displays details of all connected transceivers.

Default

None

Command Mode

Execution mode

Applicability

This command was introduced before OcNOS version 1.3.

Example

```
#show interface xe52/1 controllers
Port Number           : 52
Vendor oui            : 0x0 0x17 0x6a
Vendor name           : AVAGO
Vendor part_no        : AFBR-79E4Z
serial_number         : QB380161
transceiver_type      : QSFP OR LATER
connector_type        : MPO 1x12
qsfp_transceiver_code : 1X-LX
vendor_rev            : 01
date_code             : 110920      (yyymmddvv, v=vendor specific)
encoding              : SONET
br_nominal            : 103         (100 MHz)
length_km             : 0
length_mtr            : 50
length_50mt           : 0
length_62_5mt         : 0
length_cu             : 0
cc_base               : 0x7d
cc_ext                : 0x28
DDM Support           : yes
```

show interface all transceiver detail

Use this command to display EDFA module input power, output power, pump bias and gain threshold and current values from all ports.

Command Syntax

```
show interface transceiver detail
```

Parameters

None

Default

None

Command Mode

Execution mode and Privileged execution mode

Applicability

Introduced before OcNOS version 6.3.0.

Example

```
OcNOS>show interface transceiver detail
Codes: * Not Qualified By IP Infusion, ** Not Supported By Module, -- No Power, - Not Applicable
...
Intf      DDM      InPwr      AlertMax    CritMax     CritMin     AlertMin
      (dBm)      (dBm)      (dBm)      (dBm)      (dBm)      (dBm)
-----
ce0      Inactive* -8.12      +5.00      +4.00      -20.97     -21.94
Intf      DDM      OutPwr      AlertMax    CritMax     CritMin     AlertMin
      (dBm)      (dBm)      (dBm)      (dBm)      (dBm)      (dBm)
-----
ce0      Inactive* +8.83      +20.00     +18.00     -10.00     -11.94
Intf      DDM      PumpBias    AlertMax    CritMax     CritMin     AlertMin
      (Amp)      (Amp)      (Amp)      (Amp)      (Amp)      (Amp)
-----
ce0      Inactive* +0.11      +0.59      +0.53      +0.00      +0.00
Intf      DDM      Gain        AlertMax    CritMax     CritMin     AlertMin
      (dB)      (dB)      (dB)      (dB)      (dB)      (dB)
-----
ce0      Inactive* +16.97     +26.00     +25.00     +8.00      +7.00
```

show interface controller details

Use this command to display the EEPROM details.

Command Syntax

```
show interface (IFNAME|) controllers (remote)
```

Parameters

IFNAME

Interface name. If not specified, this command displays details of all connected transceivers.

remote

Interface name

Default

None

Command Mode

Execution mode

Applicability

This command was introduced in OcNOS version 6.2.0

Example

The following command displays detailed information of smart SFP.

```
OcNOS#show interface controllers remote
Codes: SMF - Single Mode Fiber, MMF - Multi Mode Fiber, FC - Fiber Channel
OM1 - 62.5 Micron MMF [200MHzkm @ 850nm & 500MHzkm @ 1310nm]
OM2 - 50 Micron MMF [500MHzkm @ 850nm & [500MHzkm @ 1310nm]
OM3 - 50 Micron MMF [2000MHz*km @ 850nm], OUI - Vendor ID
OM4 - 50 Micron MMF [4700MHz*km @ 850nm], BR - Bit Rate, CC - Check Code
AOC - Active Optical Cable, ACC - Active Copper Cable, PC - Power Class
CDR - Clock Data Recovery, CLEI - Common Language Equipment Identification
LR - Long Reach, SR - Short Reach, IR - Intermediate Reach
CCA - Copper Cable Attenuation

#####
Port Number          : 24
Name                 : WTD
OUI                  : 0x0 0x1c 0xad
Part No              : RTXM330-8921
Serial_Number        : ME223702430001
Identifier           : SFP/SFP+/SFP28
Ext. Identifier      : GBIC/SFP Is Defined By Two-Wire Interface ID Only
Connector Type       : LC (Lucent Connector)
Ethernet/Ext-Eth Compliance : 100GBASE-LR4 or 25GBASE-LR
SONET Compliance     :
Infiniband Compliance :
ESCON Compliance     :
FCLink Length        :
FC Technology         :
```

```
FC Transmission Media      :
FC Speed                  :
SFP+ Cable Technology     :
Length SMF                : 10 (Kilometers)
Length SMF                : 100 (X 100 Meters)
Length OM1                : 0 (X 10 Meters)
Length OM2                : 0 (X 10 Meters)
Length OM3                : 0 (X 10 Meters)
Length OM4                : 0 (X 10 Meters)
Revision Level           : V01
Wavelength                : 1269nm
Manufacturing Date       : 220809 (yyymmddvv, v=vendor specific)
Encoding Algorithm       : 64B/66B
CC                        : 0x25
CC Ext.                  : 0x68
Nominal BR                : 255 (X 100 MBd)
Max BR                   : 103
Min BR                   : 0
Options Implemented      : Power Level 3
                          Paging
                          Internal Re-Timer Or CDR
                          Cooled Laser Trasnmitter
                          Power Level 2
                          RATE_SELECT
                          TX_DISABLE
                          TX_FAULT
                          Rx Loss Of Signal (LOS)
DDM Support              : Yes
```

show interface frequency grid

Use this command to display channel-number and wavelength mapping.

Command Syntax

```
show interface (IFNAME) frequency-grid
```

Parameters

IFNAME

Interface name.

Default

None

Command Mode

Execution mode

Applicability

This command was introduced in OcNOS version 4.1.

Example

```
#show interface xe7 frequency-grid
```

```
-----  
Channel Number  Frequency (THz)  Wavelength (nm)  
-----
```

1	191.40	1566.314
2	191.50	1565.496
3	191.60	1564.679
4	191.70	1563.862
5	191.80	1563.047
6	191.90	1562.233
7	192.00	1561.419
8	192.10	1560.606
9	192.20	1559.794
10	192.30	1558.983
11	192.40	1558.172
12	192.50	1557.363
13	192.60	1556.554
14	192.70	1555.746
15	192.80	1554.939
16	192.90	1554.133
17	193.00	1553.328
18	193.10	1552.524
19	193.20	1551.720
20	193.30	1550.917
21	193.40	1550.115
22	193.50	1549.314
23	193.60	1548.514
24	193.70	1547.714
25	193.80	1546.916*
26	193.90	1546.118
27	194.00	1545.321
28	194.10	1544.525

29	194.20	1543.729
30	194.30	1542.934
31	194.40	1542.141
32	194.50	1541.348
33	194.60	1540.556
34	194.70	1539.765
35	194.80	1538.974
36	194.90	1538.184
37	195.00	1537.396
38	195.10	1536.607
39	195.20	1535.820
40	195.30	1535.034
41	195.40	1534.248
42	195.50	1533.463
43	195.60	1532.679
44	195.70	1531.896
45	195.80	1531.114
46	195.90	1530.332
47	196.00	1529.551
48	196.10	1528.771
#		

show interface transceiver details

Use this command to display details of transceivers and threshold violations.

Command Syntax

```
show interface (IFNAME|) transceiver (detail|threshold violation|(protocol (stats|))|) (remote|)
```

Parameters

IFNAME

Interface name. If not specified, this command displays details of all connected transceivers.

detail

Transceiver information such as voltage, temperature, power, and current.

threshold violation

Transceiver threshold violations.

Codes

* Not Qualified By IP Infusion, ** Not Supported By Module.

Default

None

Command Mode

Execution mode

Applicability

This command was introduced before OcNOS version 6.2.0.

Example

The following command displays detailed information of interface transceiver details.

```
OcNOS#sh int transceiver detail
Codes: * Not Qualified By IP Infusion, ** Not Supported ByModule, -- No Power, - Not Applicable
Intf      DDM          Temp          AlertMax      CritMax      CritMin      AlertMin
          (Celsius)    (Celsius)    (Celsius)    (Celsius)    (Celsius)
-----
ce0       Active*       +22.52       +85.00       +80.00       -5.00       -10.00
ce2       Active        +20.32       +75.00       +70.00       +0.00       -5.00
xe4       Active*       +23.62       +95.00       +85.00       -40.00      -50.00
xe5       Active*       +19.79       +100.00      +95.00       -35.00      -40.00
xe16      Active*       +25.84       +95.00       +85.00       -10.00      -50.00
xe26      Active        +19.01       +95.00       +90.00       -20.00      -25.00
Intf      DDM          Volt          AlertMax      CritMax      CritMin      AlertMin
          (Volts)      (Volts)      (Volts)      (Volts)      (Volts)
-----
ce0       Active*       +3.314       +3.600       +3.500       +3.100       +2.900
ce2       Active        +3.260       +3.630       +3.465       +3.135       +2.970
xe4       Active*       +3.260       +3.600       +3.500       +3.100       +3.000
xe5       Active*       +3.253       +3.600       +3.500       +2.900       +2.800
xe16      Active*       +3.284       +3.630       +3.500       +3.030       +2.930
xe26      Active        +3.289       +3.900       +3.700       +2.900       +2.700
Intf      DDM          Lane          Curr          AlertMax      CritMax      CritMin      AlertMin
```

			(mA)	(mA)	(mA)	(mA)	(mA)
ce0	Active*	1	+6.114	+15.000	+12.000	+2.000	+0.000
		2	+6.120	+15.000	+12.000	+2.000	+0.000
		3	+6.110	+15.000	+12.000	+2.000	+0.000
		4	+6.116	+15.000	+12.000	+2.000	+0.000
ce2	Active	1	+7.464	+13.000	+11.000	+5.000	+3.000
		2	+7.540	+13.000	+11.000	+5.000	+3.000
		3	+7.444	+13.000	+11.000	+5.000	+3.000
		4	+7.474	+13.000	+11.000	+5.000	+3.000
xe4	Active*	-	+6.100	+110.000	+100.000	+1.000	+1.000
xe5	Active*	-	+7.552	+15.000	+13.000	+2.000	+1.000
xe16	Active*	-	+5.800	+15.000	+12.000	+3.000	+2.000
xe26	Active	-	+7.050	+17.000	+14.000	+2.000	+1.000
Intf	DDM	Lane	RxPwr (dBm)	AlertMax (dBm)	CritMax (dBm)	CritMin (dBm)	AlertMin (dBm)
ce0	Active*	1	-0.185	+4.400	+3.400	-13.298	-14.306
		2	+0.342	+4.400	+3.400	-13.298	-14.306
		3	+0.396	+4.400	+3.400	-13.298	-14.306
		4	-2.927	+4.400	+3.400	-13.298	-14.306
ce2	Active	1	+1.302	+3.400	+2.400	-11.002	-14.001
		2	+1.486	+3.400	+2.400	-11.002	-14.001
		3	+1.581	+3.400	+2.400	-11.002	-14.001
		4	+1.594	+3.400	+2.400	-11.002	-14.001
xe4	Active*	-	-1.890	+2.500	+0.500	-14.401	-16.402
xe5	Active*	-	-40.000	+3.000	+0.000	-13.002	-16.003
xe16	Active*	-	--	+2.000	+1.000	-14.401	-16.402
xe26	Active	-	-5.933	+1.000	-1.002	-18.013	-20.000
Intf	DDM	Lane	TxPwr (dBm)	AlertMax (dBm)	CritMax (dBm)	CritMin (dBm)	AlertMin (dBm)
ce0	Active*	1	-0.085	+4.400	+3.400	-9.201	-10.205
		2	-0.161	+4.400	+3.400	-9.201	-10.205
		3	+0.217	+4.400	+3.400	-9.201	-10.205
		4	+0.204	+4.400	+3.400	-9.201	-10.205
ce2	Active	1	+0.297	+5.000	+3.000	-8.000	-10.000
		2	-0.078	+5.000	+3.000	-8.000	-10.000
		3	+0.131	+5.000	+3.000	-8.000	-10.000
		4	+0.323	+5.000	+3.000	-8.000	-10.000
xe4	Active*	-	-1.316	+2.500	+0.500	-8.199	-10.200
xe5	Active*	-	-2.299	+1.000	+0.000	-7.001	-8.000
xe16	Active*	-	-1.000	+2.500	+2.000	-8.199	-10.200
xe26	Active	-	-4.441	-2.000	-2.000	-11.024	-11.739
Intf	DDM	Lane	Freq-Err (GHz)	AlertMax (GHz)	CritMax (GHz)	CritMin (GHz)	AlertMin (GHz)
Intf	DDM	Lane	Wave-Err (nm)	AlertMax (nm)	CritMax (nm)	CritMin (nm)	AlertMin (nm)
Intf	DDM	Lane	Tx	Rx-LOS	Tx-LOS		
ce0	Active*	1	On	Off	Off		
		2	On	Off	Off		
		3	On	Off	Off		
		4	On	Off	Off		
ce2	Active	1	On	Off	Off		
		2	On	Off	Off		
		3	On	Off	Off		
		4	On	Off	Off		
xe4	Active*	-	On	Off	-		
xe5	Active*	-	On	On	-		
xe9	Inactive*	-	On	On	-		
xe11	Inactive*	-	On	On	-		
xe13	Inactive*	-	On	On	-		
xe14	Inactive*	-	On	On	-		
xe16	Active*	-	On	On	-		
xe26	Active	-	On	Off	-		

Here is the explanation of the show command output fields.

Table 67. show interface transceiver details output

Field	Description
Port	The number of the transceiver port.
Temp	Temperature in degrees Celsius of the transceiver.
Voltage	Voltage in Volts on the transceiver.
Current	Current in Milliamperes used by the transceiver.
Rx Power	Power received in Decibel-milliwatts (dBm) by the transceiver.
Tx Power	Power being transmitted in milliWatts by the transceiver.
High Alarm	The level that is needed to be reached to trigger a high alarm.
High Warn	The level that is needed to be reached to trigger a high warning.
Low Warn	The level that is needed to be reached to trigger a low warning.
Low Alarm	The level that is needed to be reached to trigger a low alarm.
Codes *	Not Qualified By IP Infusion, ** Not Supported By Module

show interface transceiver detail remote

Use this command to display all the threshold values for volt, temperature, and power for the remote transceiver.

Command Syntax

```
show interface (IFNAME|) transceiver detail remote
```

Parameters

IFNAME

Interface name. If not specified, this command displays details of all connected transceivers.

remote

Interface name

detail

Remote transceivers information

Default

None

Command Mode

Execution mode

Applicability

This command was introduced in OcNOS version 6.2.0.

Example

The following command displays detailed information of interface transceiver detail remote.

```
OcNOS#show interface transceiver detail remote

  Intf      DDM      Temp      AlertMax  CritMax  CritMin  AlertMin
          (Celsius) (Celsius) (Celsius) (Celsius) (Celsius)
-----
  Intf      DDM      Volt      AlertMax  CritMax  CritMin  AlertMin
          (Volts)  (Volts)  (Volts)  (Volts)  (Volts)
-----
```

show interface transceiver protocol

Use this command to display the OAM protocol status and module status of the local module.

Command Syntax

```
show interface (IFNAME|) transceiver protocol
```

Parameters

IFNAME

Interface name. If not specified, this command displays details for all connected transceivers.

protocol

OAM protocol status, and module status of local module.

Default

None

Command Mode

Execution mode

Applicability

This command was introduced in OcNOS version 6.2.0.

Example

The following command displays detailed information of interface transceiver protocol.

```
OcNOS#show interface transceiver protocol

#####
Port Number           : 2
OAM status            : On
Local status          : Link failure
```

show interface transceiver protocol remote

Use this command to display the OAM protocol status and module status of the remote module.

Command Syntax

```
show interface (IFNAME|) transceiver protocol remote
```

Parameters

IFNAME

Interface name. If not specified, this command displays details of all connected transceivers.

protocol

OAM protocol status, and module status of the remote module.

remote

Remote transceiver information

Default

None

Command Mode

Execution mode

Applicability

This command was introduced in OcNOS version 6.2.0.

Example

The following command displays detailed information of interface transceiver protocol remote.

```
OcNOS#show interface transceiver protocol remote

#####
Port Number           : 2
Remote status         : Remote TCVR Ready
```

show interface transceiver protocol stats

Use this command to display the protocol frame statistics.

Command Syntax

```
show interface (IFNAME|) transceiver protocol stats
```

Parameters

IFNAME

Interface name. If not specified, this command displays details for all connected transceivers.

protocol

OAM protocol status, and module status of local module.

stats

Protocol frame statistics

Default

None

Command Mode

Execution mode

Applicability

This command was introduced in OcNOS version 6.2.0.

Example

The following command displays detailed information of interface transceiver protocol stats.

```
OcNOS#show interface transceiver protocol stats

#####
Port Number           : 2
OAM frames Sent       : 1583
OAM frames received corretly : 1
OAM frames received with error: 2
```

show interface transceiver remote

Use this command to display the remote transceiver information.

Command Syntax

```
show interface (IFNAME|) transceiver remote
```

Parameters

IFNAME

Interface name. If not specified, this command displays details for all connected transceivers.

remote

Remote transceiver information.

Default

None

Command Mode

Execution mode

Applicability

This command was introduced in OcNOS version 6.2.0.

Example

The following command displays detailed information of interface transceiver remote

```
OcNOS#show interface transceiver remote
```

Intf	DDM	Temp	Voltage	Lane	Tx	Rx-Los	Tx-
Los	Current	TxPower	RxPower	Freq-Err	Wave-Err		
	(mA)	(Celsius)	(volt)	(GHZ)	(nm)		

show interface transceiver threshold violations remote

Use this command to display the details of remote transceivers and threshold violations.

Command Syntax

```
show interface (IFNAME|) transceiver (detail|threshold violation|) remote
```

Parameters

IFNAME

Interface name. If not specified, this command displays details of all connected transceivers.

detail

Transceiver information, such as voltage, temperature, power, and current.

threshold violation

Transceiver threshold violations.

Default

None

Command Mode

Execution mode

Applicability

This command was introduced in OcNOS version 6.2.0.

Example

The following command displays detailed information of interface transceiver threshold violations remote.

```
OcNOS#show interface transceiver threshold violations remote
  Intf      Lane      Timestamp      Type of alarm
  ----      -
  -----
```

show supported-transceiver

Use this command to display supported transceivers.

Command Syntax

```
show supported-transceiver
```

Parameters

None

Default

None

Command Mode

Execution mode

Applicability

This command was introduced before OcNOS version 1.3.

Example

```
#show supported-transceiver
-----
          Transceiver DDM support list
-----
Type                :SFP
Vendor Name         :FINISAR CORP
Vendor Part Number  :FTLF8519P2BNL
DDM Supported       :Yes
Type                :SFP
Vendor Name         :EVERTZ
Vendor Part Number  :SFP10G-TR13S
DDM Supported       :Yes
Type                :QSFP
Vendor Name         :AVAGO
Vendor Part Number  :AFBR-79E4Z
DDM Supported       :Yes
```

tx-disable

Use this command to disable the transceiver tx-power (disable laser).

Use the **no** form of this command to enable tx-power (enable laser).

Command Syntax

```
tx-disable
no tx-disable
```

Parameters

None

Default

By default, **tx-disable** is false.

Command Mode

Interface mode

Applicability

This command was introduced before OcNOS version 4.2.

Example

```
#configure terminal
(config)#interface xe1
(config-if)#tx-disable
(config-if)#exit
(config)#interface xe1
(config-if)#no tx-disable
(config-if)#exit
```

xcvr <IFNAME> tx-disable <1-256> remote

Use this command to laser off the remote transceiver for <1-256> seconds and to turn the laser ON.

Command Syntax

```
xcvr <IFNAME> tx-disable <1-256> remote
```

Parameters

IFNAME

Interface name.

remote

Remote transceiver.

Default

None

Command Mode

Execution mode

Applicability

This command was introduced in OcNOS version 6.2.0.

Example

The following command displays detailed information of xcvr <IFNAME> tx-disable <1-256> remote.

```
OcNOS#xcvr xe2 tx-disable 2 remote
```

xcvr <IFNAME> reset remote

Use this command to reset the remote transceiver.

Command Syntax

```
xcvr <IFNAME> reset remote
```

Command Syntax

IFNAME

Interface name.

remote

Remote transceiver.

reset

Reset remote transceiver

Default

None

Command Mode

Execution mode

Applicability

This command was introduced in OcNOS version 6.2.0.

Example

The following command displays detailed information of xcvr <IFNAME> reset remote.

```
OcNOS#xcvr xe2 reset remote
```

xcvr loopback

Use this command to loopback Tx and Rx Input loop back for remote.

Use this command to loopback Tx and Rx Output loop back for remote.

Command Syntax

```
xcvr loopback (in|out) remote
no xcvr loopback (in|out) remote
```

Parameters

None

Default

None

Command Mode

Interface mode

Applicability

This command was introduced in OcNOS version 6.2.0.

Example

The following command displays detailed information of xcvr loopback.

```
OcNOS(config)#int xe2
OcNOS(config-if)#xcvr loopback in remote
OcNOS(config-if)#commit
OcNOS(config-if)#end
OcNOS#conf t
OcNOS(config)#int xe2
OcNOS(config-if)#xcvr loopback out remote
OcNOS(config-if)#commit
OcNOS(config-if)#end
```

wavelength

Use this command to set the transceiver wavelength using the channel-number or the wavelength for interfaces having a supported transceiver.

Use the no form of this command to remove the wavelength configuration.

Command Syntax

```
wavelength ((channel-number <1-96>) | (update <1528773-1566723>))
```

Parameters

channel-number

Sets wavelength corresponding to the channel number

update

Sets wavelength value

Default

By default, the interface comes up with a random wavelength chosen by autotuning.

Command Mode

Interface mode

Applicability

This command was introduced in OcNOS version 4.1.

Example

```
(config)#int xe7
(config-if)#wavelength channel-number 10
(config-if)#no wavelength
(config-if)#
(config-if)#wavelength update 1528773
(config-if)#no wavelength
(config-if)#
```

LINK CONFIGURATION GUIDE

Trigger Failover Configuration	886
Basic Configuration	886
Port-Channel Configuration	887
Link Detection Debounce Timer	891
Topology	891
Configuration	891
Validation	892
Log Messages	892

Trigger Failover Configuration

This chapter contains Trigger Failover (TFO) configuration examples.

This example shows the complete configuration to enable TFO in a simple network topology. TFO complements NIC teaming functionality supported on blade servers. TFO allows a switch module to monitor specific uplink ports to detect link failures. When the switch module detects a link failure, it disables the corresponding downlink ports automatically.

TFO uses these components:

- A Fail Over Group (FOG) contains a Monitor Port Group (MPG) and a Control Port Group (CPG).
- An MPG contains only uplink ports.
- A CPG contains only downlink ports.



- TFO is supported in STP or RSTP bridge mode.
- TFO can be configured on a **LAG**¹ interface.

Basic Configuration

Figure 51. Basic topology

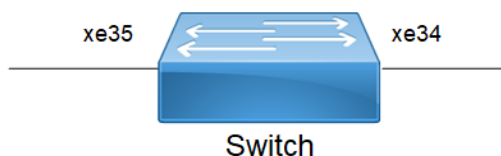

Switch

#configure terminal	Enter configure mode.
(config)#tfo enable	Enable TFO globally.
(config)#fog 1 enable	Create a Fail over group (FOG) and enable it.
(config)#interface xe35	Enter interface mode
(config-if)#link-type uplink	Specify the link-type as Uplink.
(config-if)#fog 1 type mpg	Specify the MPG member for FOG 1.
(config-if)#exit	Exit interface mode
(config)#commit	Commit the candidate configuration to the running configuration
(config)#interface xe34	Enter interface mode
(config-if)#link-type downlink	Specify the link-type as Downlink.

¹Link Aggregation Group

(config-if)#fog 1 type cpg	Specify the CPG member for FOG 1.
(config-if)#commit	Commit the candidate configuration to the running configuration
(config-if)#end	Exit interface and configure mode

Validation

```
OcNOS#show tfo

TFO : Enable

Failover Group 1 : Enable
Failover Status : NONE
No. of links to trigger failover : 0

MPG Port      Status
-----
xe10          UP

CPG Port      Status
-----
xe11          UP

No. of times MPG link failure : 0
No. of times MPG link recovered : 0
No. of times CPG got auto disabled : 0
No. of times CPG got auto enable : 0
```

Port-Channel Configuration

Topology

Figure 52. TFO with port-channel

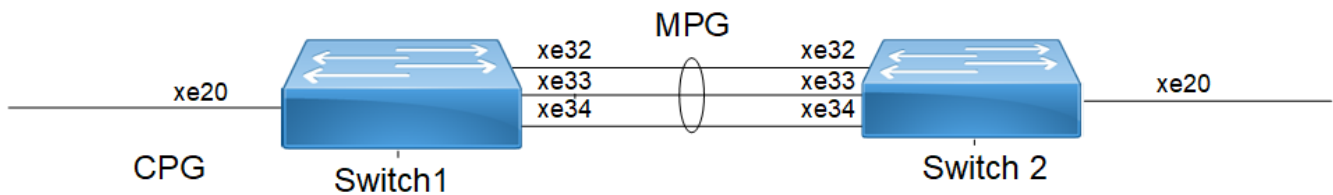

Switch 1

#configure terminal	Enter configure mode.
(config)#tfo enable	Enable TFO globally.
(config)#fog 1 enable	Create a Fail over group (FOG) and enable it.
(config)#interface po1	Enter interface mode
(config-if)#switchport	Make the interface Layer2.
(config-if)#exit	Exit interface mode
(config)#commit	Commit the candidate configuration to the running

	configuration
(config)#interface xe32	Enter interface mode
(config-if)#switchport	Make the interface Layer2.
(config-if)#link-type uplink	Specify the link-type as Uplink.
(config-if)#exit	Exit interface mode
(config)#commit	Commit the candidate configuration to the running configuration
(config)#interface xe33	Enter interface mode
(config-if)#switchport	Make the interface as Layer2.
(config-if)#link-type uplink	Specify the link-type as Uplink.
(config-if)#channel-group 1 mode active	Specify the channel group in interface
(config-if)#exit	Exit interface mode
(config)#commit	Commit the candidate configuration to the running configuration
(config)#interface xe34	Enter interface mode
(config-if)#switchport	Make the interface as Layer2.
(config-if)#link-type uplink	Specify the link-type as Uplink.
(config-if)#channel-group 1 mode active	Specify the channel group in interface
(config-if)#exit	Exit interface mode
(config)#commit	Commit the candidate configuration to the running configuration
(config)#interface xe20	Enter interface mode
(config-if)#link-type downlink	Specify the link-type as Downlink.
(config-if)#fog 1 type cpg	Specify the CPG member for FOG 1
(config-if)#fog 1 type mpg	Specify the MPG member for FOG 1.
(config-if)#exit	Exit interface mode
(config)#commit	Commit the candidate configuration to the running configuration
(config)#interface po1	Enter port-channel mode
(config-if)#link-type uplink	Specify the link-type as Uplink.
(config-if)#fog 1 type mpg	Specify the MPG member for FOG 1.
(config-if)#fog 1 type cpg	Specify the CPG member for FOG 1.
(config-if)#commit	Commit the candidate configuration to the running configuration
(config-if)#end	Exit interface and configure mode

Switch 2

#configure terminal	Enter configure mode.
---------------------	-----------------------

(config)#interface po1	Enter interface mode
(config-if)#switchport	Make the interface as Layer2.
(config-if)#exit	Exit interface mode
(config-if)#commit	Commit the candidate configuration to the running configuration
(config)#interface xe32	Enter interface mode
(config-if)#switchport	Make the interface as Layer2.
(config-if)#channel-group 1 mode active	Specify the channel group in interface
(config-if)#exit	Exit interface mode
(config-if)#commit	Commit the candidate configuration to the running configuration
(config)#interface xe33	Enter interface mode
(config-if)#switchport	Make the interface as Layer2.
(config-if)#channel-group 1 mode active	Specify the channel group in interface
(config-if)#exit	Exit interface mode
(config)#commit	Commit the candidate configuration to the running configuration
(config)#interface xe34	Enter interface mode
(config-if)#switchport	Make the interface as Layer2
(config-if)#channel-group 1 mode active	Specify the channel group in interface
(config-if)#exit	Exit interface mode
(config)#commit	Commit the candidate configuration to the running configuration

Validation

```
#show interface brief | include up
xe20      ETH  --  --          up    none  10g  --
xe32      ETH  --  --          up    none  10g  --
xe33      ETH  --  --          up    none  10g  --
xe34      ETH  --  --          up    none  10g  --
eth0      METH          up    --    100m
lo                up    --
lo.management    up    --
```

```
#show tfo
```

```
TFO : Enable
```

```
Failover Group 1 : Enable
Failover Status : MPG Link Failure
No. of links to trigger failover : 0
MPG Port(s) :
po1 Status : DOWN
CPG Port :
xe20 Status : DOWN
No. of times MPG link failure : 0
No. of times MPG link recovered : 0
No. of times CPG got auto disabled : 0
```

No. of times CPG got auto enable : 0

Link Detection Debounce Timer

The link debounce timer avoids frequent updates (churn) to higher layer protocols during flapping of an interface. The initial link state is UP. The link goes DOWN. If the Link comes UP and goes DOWN, The link DOWN AND link UP timer is started and being restarted on each flap (link comes up and goes down again). For each link DOWN, link down timer will start and it restarts on flap within the link debounce interval. For each link UP, link up timer will start and it restarts on flap within the link debounce interval.



Notes: Keep the following in mind when using the Link detection debounce timer:

- Link debounce timer is supported only for physical L2 and L3 interfaces.
- When debounce timer is configured we won't be able to configure the link-debounce-timer config and viceversa.
- The link debounce flap-count refers to the number of flaps OcNOS receives while the debounce timer is running:
 - The flap-count is only updated if the timer is still running and OcNOS receives a link status event for the interface.
 - The flap-count is reset at the subsequent start of the link debounce timer.
- Protocol-specific timers such as BFD which depend on the link status should be configured to minimum of 1.5 times the value of the link-debounce time. Otherwise it could affect the protocol states if the link debounce timer is still running.
- Protocols such as PO, OSPF, BFD, ISIS, BGP which depends on the link status, in this case we should ensure on both the connected interfaces we need to configure the link-debounce timer.
- The debounce timer must be configured on both ends of the network link.
- Enabling the debounce timer delays the detection of link up and down status, resulting in traffic loss during that period and impacting the convergence of some protocols.

Topology

Figure 53. Link detection debounce timer topology

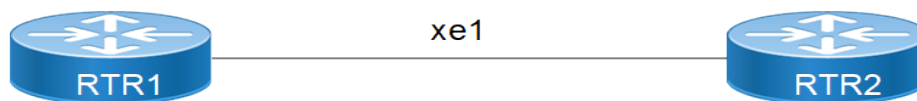

Configuration

RTR1

<code>#configure terminal</code>	Enter configure mode.
<code>(config)#interface xe1</code>	Enter interface mode
<code>(config-if)#link-debounce-time 4000 5000</code>	Configure link-debounce-time where link-up timer is

	4000 ms and link-down timer is 5000 ms
(config-if)#commit	Commit the candidate configuration to the running configuration
(config-if)#exit	Exit interface mode

RTR2

#configure terminal	Enter configure mode.
(config)#interface xe1	Enter interface mode.
(config-if)#link-debounce-time 4000 5000	Configure link-debounce-time where link-up timer is 4000 ms and link-down timer is 5000 ms
(config-if)#commit	Commit the candidate configuration to the running configuration.
(config-if)#exit	Exit interface mode.

Validation

```
#show interface xe1 | i Debounce Link Debounce timer: enable
  Linkup Debounce time 4000 ms Linkdown Debounce time 5000 ms
  Linkup Debounce status : idle
  Linkdown Debounce status : idle
```

RTR1 and RTR2 outputs after interface flap:

```
#show interface xe1 | i debounce Link Debounce timer: enable
  Linkup Debounce time 4000 ms Linkdown Debounce time 5000 ms
  Flap Count: 1
  Last Debounce Flap :
  Linkup Debounce status : idle
  Linkdown Debounce status : idle

#show interface xe1 | i debounce
  Link Debounce timer: enable
  Linkup Debounce time 4000 ms Linkdown Debounce time 5000 ms
  Flap Count: 1
  Last Debounce Flap :   Linkup Debounce status : idle
  Linkdown Debounce status : idle
```

Log Messages

The following is a configuration example to log link debounce timer activity

#configure terminal	Enter Configure mode
(config)#logging level nsm 7	Enable operational log to display debounce start and end.

Example Log Messages

```
2019 Feb 28 02:50:40.761 : OcNOS : NSM : INFO : Start UP->DOWN Link Debounce Timer on interface xe1
2019 Feb 28 02:50:40.761 : OcNOS : NSM : NOTIF : [DEBOUNCE_EVENT_4]: Interface xe1 changed state from up to down
2019 Feb 28 02:50:43.543 : OcNOS : NSM : INFO : Start DOWN->UP Link Debounce Timer on interface xe1
```

```
2019 Feb 28 02:50:43.543 : OcNOS : NSM : INFO : Interface xe1 Flapped, prev_state DOWN new_state
UP,flap count 1
2019 Feb 28 02:50:43.543 : OcNOS : NSM : NOTIF : [DEBOUNCE_EVENT_4]: Interface xe1 changed state from
down to up
2019 Feb 28 02:50:45.761 : OcNOS : NSM : INFO : Link Debounce Timer Expired on interface xe1
(initiated transition up->down), prev_state UP, new_state UP

2019 Feb 28 02:50:47.544 : OcNOS : NSM : INFO : Link Debounce Timer Expired on interface xe1
(initiated transition down->up), prev_state UP, new_state UP
```

LINK COMMAND REFERENCE

Trigger Failover Commands	895
clear tfo counter	895
fog	895
fog tfo	896
fog type	897
link-type	898
show tfo	899
tfo	900

Trigger Failover Commands

This chapter describes the trigger failover (TFO) commands.

clear tfo counter	895
fog	895
fog tfo	896
fog type	897
link-type	898
show tfo	899
tfo	900

clear tfo counter

Use this command to clear the TFO counters. If you do not specify a parameter, this command clears counters for all FOG indexes.

Command Syntax

```
clear tfo counter
clear tfo counter fog <1-64>
```

Parameters

<1-64>

Clear counters for this Failover Group Index

Default

None

Command Mode

Execution mode

Applicability

This command was introduced before OcNOS version 1.3.

Example

```
#clear tfo counter
```

fog

Use this command to:

- Create or delete a failover group (FOG)
- Enable or disable an existing FOG

Even if FOG index do not exist, FOG can be created as enabled with “enable” option in CLI.

If the FOG index already exists:

- When the FOG status is disabled and Control Port Group (CPG) links are previously disabled (because of TFO), then the links are enabled. If a particular CPG member belongs to multiple CPGs, then this CPG member is enabled only if all corresponding Monitor Port Groups (MPG) are enabled.
- When the FOG status is enabled and MPG is down, then the corresponding CPG links are disabled.

Use the **no** form of this command to delete a FOG.

Command Syntax

```
fog <1-64> (enable|disable)
no fog <1-64>
```

Parameters

<1-64>

Failover Group Index

enable

Enable Failover Group

disable

Disable Failover Group

Default

None

Command Mode

Configure mode

Applicability

This command was introduced before OcNOS version 1.3.

Example

```
#configure terminal
(config)#fog 5 enable
```

fog tfc

Use this command to set the number of links to trigger failover for a Monitor Port Groups (MPG).

Use the no form of this command to remove the configuration and use default value of 0.

Command Syntax

```
fog <1-64> tfc <0-63>  
no fog <1-64> tfc
```

Parameters

<1-64>

Failover Group index

<0-63>

Trigger failover count

Default

None

Command Mode

Configure mode

Applicability

This command was introduced before OcNOS version 1.3. The **no** version of the command was introduced in OcNOS version 4.0.

Example

```
#configure terminal  
(config)#fog 5 tfc 7  
(config)# no fog 5 tfc
```

fog type

Use this command to map upstream/downstream links in a FOG as a Monitor Port Group (MPG) or Control Port Group (CPG).

Use the **no** form of this command to unmap upstream/downstream links.

Command Syntax

```
fog <1-64> type (mpg|cpg)  
no fog <1-64> type (mpg|cpg)
```

Parameters

<1-64>

Failover Group Index

mpg

Map the interface to an MPG

cpg

Map the interface to a CPG

Default

None

Command Mode

Interface mode

Applicability

This command was introduced before OcNOS version 1.3.

Example

```
#configure terminal
#interface eth1
(config-if)#fog 5 type mpg
```

link-type

Use this command to make a port an uplink or downlink.

Use the **no** form of this command to remove the configuration.

Command Syntax

```
link-type (uplink|downlink)
no link-type
```

Parameters

uplink

Make the port an uplink

downlink

Make the port a downlink

Default

None

Command Mode

Interface mode

Applicability

This command was introduced before OcNOS version 1.3.

Example

```
#configure terminal
#interface eth1
(config-if)#link-type downlink
```

show tfo

Use this command to display FOG configuration and statistics.

Command Syntax

```
show tfo
```

Parameters

None

Default

None

Command Mode

Execution mode

Applicability

This command was introduced before OcNOS version 1.3.

Example

```
#show tfo

TFO : Enable

Failover Group 1 : Enable
Failover Status : MPG Link Failure
No. of links to trigger failover : 0
MPG Port(s) :
xe9   Status : DOWN
xe12  Status : DOWN
CPG Port :
xe4   Status : DOWN
No. of times MPG link failure : 1
No. of times MPG link recovered : 0
No. of times CPG got auto disabled : 1
No. of times CPG got auto enable : 0
```

[Table 68](#) Explains the show command output fields.

Table 68. show tfo output fields

Field	Description
Failover Group	Enable the failover group.
Failover Status	Display the failover status.
No. of links to trigger failover	Number of links to trigger the failover group.
MPG Port	Details of the monitor port group.
CPG Port	Details of the control port group.

tfo

Use this command to enable or disable trigger failover (TFO).

Command Syntax

```
tfo (enable|disable)
```

Parameters

enable

Enables Trigger failover

disable

Disables Trigger failover

Default

By default, TFO is disabled.

Command Mode

Configure mode

Applicability

This command was introduced before OcNOS version 1.3.

Example

```
#configure terminal  
(config)#tfo enable
```

QSFP-DD CONFIGURATION GUIDE

QSFP-DD Configuration	902
Overview	902
System Description	902
Objectives	902
Topology	902
Loopback	903
PRBS	906
Application	912
Custom Application	915
Laser Tuning	917
QSFP-DD Monitored Alarms	925
Remote Fault and Local Fault Alarms	932
Signal Integrity in QSFP-DD	950
400G PM Alarm	979
Overview	979
Prerequisites	979
Configuration	980
New CLI Commands	985
Abbreviations	998

QSFP-DD Configuration

Overview

QSFP-DD¹ is a new module developed but with the same form factor as the current QSFP, to support high-speed solutions. It provides eight lanes electrical interface. Each lane can operate up to 25Gbps NRZ modulation or 50Gbps PAM4 modulation. QSFP modules are designed to be backward compatible with the existing QSFP modules.

System Description

Basically, the system will be developed to support 400Gbps data transmission. This will enable us to support the high-speed solution. The management interface will be used to get the status and control of the module.

CMIS modules have two physical interfaces for signal transmission:

Host Interface (Device to device interconnection)

The host interface is the high-speed electrical interface between the module and the host system. The host interface carries signals traveling from host to module (transmitter input signals) and signals traveling from module to host (receiver output signals). All electrical signals carried over the host interface are transmitted over the wire pairs, each of which is called host lanes.

Media Interface (Device to media interconnection)

The media interface is the high-speed electrical/optical interface between the module and the interconnecting media. The media interface carries signals that travel from module to media (transmitter output signals) and signals that travel from media to module (receiver input signals). Media interface signals are carried either over electrical wire pairs (Copper cables) or over optical wavelengths on physical fibers, which are called media lanes.

Objectives

The objective of this document is to provide a high-speed solution using QSFP-DD. The management characteristics, status, and control of QSFP-DD.

Topology

Figure 54. QSFP-DD Sample Topology



¹QSFP-DD stands for Quad Small Form Factor Pluggable Double Density. QSFP-DD modules provide a scalable, high-bandwidth solution for data center networking, enabling efficient data transmission and network performance in modern computing environments.

Loopback

Use this command to configure the loopback type (input, output, both) on the **QSFP-DD¹** module host/media side. If the loopback type is supported by the QSFP-DD module this will enable the loopback function.

Media Input Loopback

Use this command to configure the input loopback type on the QSFP-DD module media side. If the loopback type is supported by the QSFP-DD module this will enable the loopback function.

ROUTER1

ROUTER1#configure terminal	Enter configure mode.
ROUTER1(config)# qsfp-dd 0	Entering to QSFP-DD mode.
ROUTER1(config-qsfp-dd)#loopback in media	Configure input media Loopback.
ROUTER1(config-qsfp-dd)#commit	Commit the configuration.

Validation of Media Input Loopback

```
OcNOS#show qsfp-dd 0 diagnostics media loopback
```

```
Port Number           : 0
```

```
-----
User Config | H/W Config |
-----
Input       | Input       |
```

Media Output Loopback

Use this command to configure the output loopback type on the QSFP-DD module media side. If the loopback type is supported by the QSFP-DD module this will enable the loopback function.

ROUTER1

ROUTER1#configure terminal	Enter configure mode.
ROUTER1(config)#qsfp-dd 0	Entering to QSFP-DD mode.
ROUTER1(config-qsfp-dd)#loopback out media	Configure output media Loopback.
ROUTER1(config-qsfp-dd)#commit	Commit the configuration.

Validation of Media Output Loopback

```
OcNOS#show qsfp-dd 0 diagnostics media loopback
```

```
Port Number           : 0
```

```
-----
```

¹QSFP-DD stands for Quad Small Form Factor Pluggable Double Density. QSFP-DD modules provide a scalable, high-bandwidth solution for data center networking, enabling efficient data transmission and network performance in modern computing environments.

```

User Config | H/W Config |
-----
Output      | Output      |
    
```

Media Both Loopback

Use this command to configure the both loopback type on the QSFP-DD module media side. If the loopback type is supported by the QSFP-DD module this will enable the loopback function.

ROUTER1

ROUTER1#configure terminal	Enter configure mode.
ROUTER1 (config)#qsfp-dd 0	Entering to QSFP-DD mode.
ROUTER1 (config-qsfp-dd)#loopback both media	Configure both input & output media Loopback.
ROUTER1 (config-qsfp-dd)#commit	Commit the configuration.

Validation of Media Both Loopback

```

OcNOS#show qsfp-dd 0 diagnostics media loopback

Port Number           : 0

-----
User Config | H/W Config |
-----
Input/Output      | Input/Output      |
    
```

Host Input Loopback

Use this command to configure the input loopback type on the QSFP-DD module host side. If the loopback type is supported by the QSFP-DD module this will enable the loopback function.

ROUTER1

ROUTER1#configure terminal	Enter configure mode.
ROUTER1 (config)#qsfp-dd 0	Entering to QSFP-DD mode.
ROUTER1 (config-qsfp-dd)#loopback in host	Configure input host Loopback.
ROUTER1 (config-qsfp-dd)#commit	Commit the configuration.

Validation of Host Input Loopback

```

OcNOS#show qsfp-dd 0 diagnostics Host loopback

Port Number           : 0

-----
User Config | H/W Config |
-----
Input       | Input       |
    
```

Host Output Loopback

Use this command to configure the output loopback type on the QSFP-DD module host side. If the loopback type is supported by the QSFP-DD module this will enable the loopback function.

ROUTER1

ROUTER1#configure terminal	Enter configure mode.
ROUTER1 (config)#qsfp-dd 0	Entering to QSFP-DD mode.
ROUTER1 (config-qsfp-dd)#loopback out host	Configure output host Loopback.
ROUTER1 (config-qsfp-dd)#commit	Commit the configuration.

Validation of Host Output Loopback

```
OcNOS#show qsfp-dd 0 diagnostics Host loopback

Port Number           : 0

-----
  User Config | H/W Config |
-----
Output       | Output     |
```

Host Both Loopback

Use this command to configure the both loopback type on the QSFP-DD module Host side. If the loopback type is supported by the QSFP-DD module this will enable the loopback function.

ROUTER1

ROUTER1#configure terminal	Enter configure mode.
ROUTER1 (config)#qsfp-dd 0	Entering to QSFP-DD mode.
ROUTER1 (config-qsfp-dd)#loopback both host	Configure both input & output host Loopback.
ROUTER1 (config-qsfp-dd)#commit	Commit the configuration.

Validation of Host Both Loopback

```
OcNOS#show qsfp-dd 0 diagnostics Host loopback

Port Number           : 0

-----
  User Config | H/W Config |
-----
Input/Output   | Input/Output |
```

PRBS

Use these commands to configure the PRBS pattern generator/checker type to be used for diagnostics of the **QSFP-DD¹** module host/media side and to configure the PRBS pattern generator/checker location (pre-fec/post-fec) on the QSFP-DD module host/media side. If the generator/checker pattern type and location are supported by the QSFP-DD module this will enable the selected function.

Use the no parameter to remove this configuration and disable the generator/checker function.

PRBS Host Checker & Generator

ROUTER1 (checker)

ROUTER1#configure terminal	Enter configure mode.
ROUTER1 (config)#qsfp-dd 3	Entering to QSFP-DD mode.
ROUTER1 (config-qsfp-dd)#prbs checker type 15 host	Configure PRBS checker type.
ROUTER1 (config-qsfp-dd)#commit	Commit the configuration.

ROUTER2 (generator)

ROUTER2#configure terminal	Enter configure mode.
ROUTER2 (config)#qsfp-dd 3	Entering to QSFP-DD mode.
ROUTER2 (config-qsfp-dd)#prbs generator type 15 host	Configure PRBS generator type.
ROUTER2 (config-qsfp-dd)#commit	Commit the configuration.

Validation

ROUTER1

```
OcNOS#show qsfp-dd 3 diagnostics host prbs

Port Number           : 3

-----
      Generator Type
-----
User Config | H/W Config |
-----
None       | PRBS-31Q   |
-----

      Checker Type
-----
User Config | H/W Config |
-----
PRBS-15    | PRBS-15    |
-----

      Generator
-----
User Config | H/W Config | Status |
```

¹QSFP-DD stands for Quad Small Form Factor Pluggable Double Density. QSFP-DD modules provide a scalable, high-bandwidth solution for data center networking, enabling efficient data transmission and network performance in modern computing environments.

```

-----
None          | Pre-FEC     | Inactive |
-----
Checker
-----
User Config | H/W Config | Status |
-----
None          | Pre-FEC     | Active  |
    
```

ROUTER2

OcNOS#show qsf-p-dd 3 diagnostics host prbs

```

Port Number           : 3

-----
Generator Type
-----
User Config | H/W Config |
-----
PRBS-15     | PRBS-15    |
-----
Checker Type
-----
User Config | H/W Config |
-----
None        | PRBS-31Q   |
-----
Generator
-----
User Config | H/W Config | Status |
-----
None        | Pre-FEC    | Active |
-----
Checker
-----
User Config | H/W Config | Status |
-----
None        | Pre-FEC    | Inactive |
    
```

Unconfigure PRBS Host Checker & Generator

ROUTER1 (checker)

ROUTER1#configure terminal	Enter configure mode.
ROUTER1 (config)#qsf-p-dd 3	Entering to QSFP-DD mode.
ROUTER1 (config-qsf-p-dd)#no prbs checker type host	Unconfigure PRBS checker type.
ROUTER1 (config-qsf-p-dd)#commit	Commit the configuration.
ROUTER1#configure terminal	Enter configure mode.
ROUTER1 (config)#qsf-p-dd 3	Entering to QSFP-DD mode.
ROUTER1 (config-qsf-p-dd)#no prbs generator type host	Unconfigure PRBS generator type.
ROUTER1 (config-qsf-p-dd)#commit	Commit the configuration.

Validation**ROUTER1**

```
OcNOS#show qsfm-dd 3 diagnostics host prbs
Port Number                : 3
-----
Generator Type
-----
User Config | H/W Config |
-----
None        | PRBS-31Q  |
-----
Checker Type
-----
User Config | H/W Config |
-----
None        | PRBS-31Q  |
-----
Generator
-----
User Config | H/W Config | Status |
-----
None        | Pre-FEC   | Inactive |
-----
Checker
-----
User Config | H/W Config | Status |
-----
None        | Pre-FEC   | Inactive |
```

ROUTER2

```
OcNOS#show qsfm-dd 3 diagnostics host prbs
Port Number                : 3
-----
Generator Type
-----
User Config | H/W Config |
-----
None        | PRBS-31Q  |
-----
Checker Type
-----
User Config | H/W Config |
-----
None        | PRBS-31Q  |
-----
Generator
-----
User Config | H/W Config | Status |
-----
None        | Pre-FEC   | Inactive |
-----
Checker
-----
```

```

User Config | H/W Config | Status |
-----
None       | Pre-FEC    | Inactive |
    
```

PRBS Media Checker & Generator

ROUTER1 (checker)

ROUTER1#configure terminal	Enter configure mode.
ROUTER1 (config)#qsfp-dd 3	Entering to QSFP-DD mode.
ROUTER1 (config-qsfp-dd)#prbs checker type 15 media	Configure PRBS checker type.
ROUTER1 (config-qsfp-dd)#commit	Commit the configuration.

ROUTER2 (generator)

ROUTER2#configure terminal	Enter configure mode.
ROUTER2 (config)#qsfp-dd 3	Entering to QSFP-DD mode.
ROUTER2 (config-qsfp-dd)#prbs generator type 15 media	Configure PRBS generator type.
ROUTER2 (config-qsfp-dd)#commit	Commit the configuration.

Validation

ROUTER1

```
OcNOS#show qsfp-dd 3 diagnostics media prbs
```

```

Port Number           : 3

-----
Generator Type
-----
User Config | H/W Config |
-----
None       | PRBS-31Q  |

-----
Checker Type
-----
User Config | H/W Config |
-----
PRBS-15    | PRBS-15   |

-----
Generator
-----
User Config | H/W Config | Status |
-----
None       | Pre-FEC    | Inactive |

-----
Checker
-----
User Config | H/W Config | Status |
-----
None       | Pre-FEC    | Active  |
    
```

ROUTER2

```
OcNOS#show qsfp-dd 3 diagnostics media prbs

Port Number                : 3

-----
Generator Type
-----
User Config | H/W Config |
-----
PRBS-15    | PRBS-15    |
-----

Checker Type
-----
User Config | H/W Config |
-----
None       | PRBS-31Q   |
-----

Generator
-----
User Config | H/W Config | Status |
-----
None       | Pre-FEC   | Active |
-----

Checker
-----
User Config | H/W Config | Status |
-----
None       | Pre-FEC   | Inactive |
-----
```

Unconfigure PRBS Media Checker & Generator

ROUTER1 (checker)

ROUTER1#configure terminal	Enter configure mode.
ROUTER1(config)#qsfp-dd 3	Entering to QSFP-DD mode.
ROUTER1(config-qsfp-dd)#no prbs checker type media	Unconfigure PRBS checker type.
ROUTER1(config-qsfp-dd)#commit	Commit the configuration.
ROUTER1#configure terminal	Enter configure mode.
ROUTER1(config)#qsfp-dd 3	Entering to QSFP-DD mode.
ROUTER1(config-qsfp-dd)#no prbs generator type media	Unconfigure PRBS generator type.
ROUTER1(config-qsfp-dd)#commit	Commit the configuration.

Validation

ROUTER1

```
OcNOS#show qsfp-dd 3 diagnostics media prbs

Port Number                : 3

-----
```

```

Generator Type
-----
User Config | H/W Config |
-----
None        | PRBS-31Q   |
-----

Checker Type
-----
User Config | H/W Config |
-----
None        | PRBS-31Q   |
-----

Generator
-----
User Config | H/W Config | Status |
-----
None        | Pre-FEC    | Inactive |
-----

Checker
-----
User Config | H/W Config | Status |
-----
None        | Pre-FEC    | Inactive |
    
```

ROUTER2

```

OcNOS#show qsfm-dd 3 diagnostics media prbs

Port Number          : 3

-----
Generator Type
-----
User Config | H/W Config |
-----
None        | PRBS-31Q   |
-----

Checker Type
-----
User Config | H/W Config |
-----
None        | PRBS-31Q   |
-----

Generator
-----
User Config | H/W Config | Status |
-----
None        | Pre-FEC    | Inactive |
-----

Checker
-----
User Config | H/W Config | Status |
-----
None        | Pre-FEC    | Inactive |
    
```

EEPROM Details for a ZR+ Optics



Note: The below show command has output for "SO-TQSFDD4CCZRP" optics.

```
#show qsfp-dd 3 eeprom

Port Number           : 3
Identifier            : QSFP-DD Double Density 8X Pluggable Transceiver
Name                  : SmartOptics
OUI                   : 0x0 0x53 0x4f
Part No               : SO-TQSFDD4CCZRP
Revision Level        : A
Serial_Number         : 223950575
Manufacturing Date    : 220926 (yyymmddvv, v=vendor specific)
Module Power Class    : 8
Module Max Power      : 23.75 Watt
Cooling Implemented   : Yes
Module Temperature Max : 80 Celsius
Module Temperature Min : 0 Celsius
Operating Voltage Min : 3.12 Volt
Optical Detector      : PIN
Rx Power Measurement  : Average Power
Tx Disable Module Wide : No
Cable Assembly Link Length : Separable Media
Connector Type        : LC (Lucent Connector)
Media Interface Technology : 1550 nm DFB
CMIS Revision         : 4.1
Memory Model          : Paged
MCI Max Speed         : 1000 kHz
Active Firmware Revision : 61.20
Inactive Firmware Revision : 61.20
Hardware Revision     : 1.2
Media Type             : Optical SMF
Max SMF Link Length   : 630.0 Kilometer
Wavelength Nominal    : 1547.70 nm
Wavelength Tolerance  : 166.55 nm
```

Application

Use this command to select the application ID to be configured for this **QSFP-DD¹** module.



Notes:

- Only 400G application modes are supported.
- For checking the supported applications modes `show qsfp-dd <port no.> advertisement applications` command.

¹QSFP-DD stands for Quad Small Form Factor Pluggable Double Density. QSFP-DD modules provide a scalable, high-bandwidth solution for data center networking, enabling efficient data transmission and network performance in modern computing environments.

Configuration

ROUTER1

ROUTER1#configure terminal	Enter configure mode.
ROUTER1(config)# qsfp-dd 49	Entering to QSFP-DD mode.
ROUTER1(config-qsfp-dd)#application 2	Select the application ID to be configured for this QSFP-DD module
ROUTER1(config-qsfp-dd)#commit	Commit the configuration.

Validation

```
OcNOS#sh qsfp-dd 49 application

Port Number          : 49
-----
User Config   |   H/W Config
-----
Application 2 |   Application 2

OcNOS#sh qsfp-dd 49 advertisement applications

Port Number          : 49
> Application 1:
  | Host |
    Interface          : 400GAUI-8 C2M
    Application BR     : 425.00
    Lane Count         : 8
    Lane Sig BR        : 26.5625
    Modulation Format   : PAM4
    Bits Per Unit Intvl : 2.000000
    Lane Assigned      : Lane-1
  | Media |
    Interface          : 400ZR, DWDM, Amplified
    Application BR     : 478.75
    Lane Count         : 1
    Lane Sig BR        : 59.84375
    Modulation Format   : DP-16QAM
    Bits Per Unit Intvl : 8.000000
    Lane Assigned      : Lane-1
Application 2:
  | Host |
    Interface          : 400GAUI-8 C2M
    Application BR     : 425.00
    Lane Count         : 8
    Lane Sig BR        : 26.5625
    Modulation Format   : PAM4
    Bits Per Unit Intvl : 2.000000
    Lane Assigned      : Lane-1
  | Media |
    Interface          : 400ZR, Single Wavelen., Unamp.
    Application BR     : 478.75
    Lane Count         : 1
    Lane Sig BR        : 59.84375
    Modulation Format   : DP-16QAM
    Bits Per Unit Intvl : 8.000000
    Lane Assigned      : Lane-1
Application 3:
  | Host |
    Interface          : 100GAUI-2 C2M
    Application BR     : 106.25
    Lane Count         : 2
    Lane Sig BR        : 26.5625
```



```

    Modulation Format      : PAM4
    Bits Per Unit Intvl   : 2.000000
    Lane Assigned         : Lane-7/Lane-5/Lane-3/Lane-1
  | Media |
    Interface             : 400ZR, DWDM, Amplified
    Application BR        : 478.75
    Lane Count            : 1
    Lane Sig BR           : 59.84375
    Modulation Format     : DP-16QAM
    Bits Per Unit Intvl  : 8.000000
    Lane Assigned        : Lane-1
Application 4:
  | Host |
    Interface             : 400GAUI-8 C2M
    Application BR        : 425.00
    Lane Count            : 8
    Lane Sig BR           : 26.5625
    Modulation Format     : PAM4
    Bits Per Unit Intvl  : 2.000000
    Lane Assigned        : Lane-1
  | Media |
    Interface             : ZR400-OFEC-16QAM
    Application BR        : 481.108374
    Lane Count            : 1
    Lane Sig BR           : 60.1385468
    Modulation Format     : DP-16QAM
    Bits Per Unit Intvl  : 8.000000
    Lane Assigned        : Lane-1
Application 5:
  | Host |
    Interface             : 100GAUI-2 C2M
    Application BR        : 106.25
    Lane Count            : 2
    Lane Sig BR           : 26.5625
    Modulation Format     : PAM4
    Bits Per Unit Intvl  : 2.000000
    Lane Assigned        : Lane-7/Lane-5/Lane-3/Lane-1
  | Media |
    Interface             : ZR400-OFEC-16QAM
    Application BR        : 481.108374
    Lane Count            : 1
    Lane Sig BR           : 60.1385468
    Modulation Format     : DP-16QAM
    Bits Per Unit Intvl  : 8.000000
    Lane Assigned        : Lane-1
Application 6:
  | Host |
    Interface             : 100GAUI-2 C2M
    Application BR        : 106.25
    Lane Count            : 2
    Lane Sig BR           : 26.5625
    Modulation Format     : PAM4
    Bits Per Unit Intvl  : 2.000000
    Lane Assigned        : Lane-7/Lane-5/Lane-3/Lane-1
  | Media |
    Interface             : ZR300-OFEC-8QAM
    Application BR        : 360.831281
    Lane Count            : 1
    Lane Sig BR           : 60.1385468
    Modulation Format     : DP-8QAM
    Bits Per Unit Intvl  : 6.000000
    Lane Assigned        : Lane-1
Application 7:
  | Host |
    Interface             : 100GAUI-2 C2M
    Application BR        : 106.25
    Lane Count            : 2
    Lane Sig BR           : 26.5625

```

```

Modulation Format      : PAM4
Bits Per Unit Intvl   : 2.000000
Lane Assigned         : Lane-7/Lane-5/Lane-3/Lane-1
| Media |
Interface             : ZR200-OFEC-QPSK
Application BR        : 240.554187
Lane Count            : 1
Lane Sig BR           : 60.1385468
Modulation Format      : DP-QPSK
Bits Per Unit Intvl   : 4.000000
Lane Assigned         : Lane-1
Application 8:
| Host |
Interface             : 100GAUI-2 C2M
Application BR        : 106.25
Lane Count            : 2
Lane Sig BR           : 26.5625
Modulation Format      : PAM4
Bits Per Unit Intvl   : 2.000000
Lane Assigned         : Lane-7/Lane-5/Lane-3/Lane-1
| Media |
Interface             : ZR100-OFEC-QPSK
Application BR        : 120.277094
Lane Count            : 1
Lane Sig BR           : 30.069273
Modulation Format      : DP-QPSK
Bits Per Unit Intvl   : 4.000000
Lane Assigned         : Lane-1

```

Custom Application

Overview

Custom Application feature provides support to extend the current limitation of 15 applications imposed by the Common Management Interface Specification (CMIS) standard. The transceiver vendor provides support for the additional applications as a customized CMIS extension and in order to provide access to this custom extension the following new CLIs are introduced:

```

custom-app-host-id <1-32>
custom-app-media-id <1-32>

```



Note: Use `show qsfp-dd <port no> advertisement applications custom` CLI to view the supported custom applications mode.

Configurations

Perform the following configurations to configure QSFP DD custom application on the router.

1. Enter the config mode and configure the QSFP DD.

```

#configure terminal
(config)# qsfp-dd 0

```

2. Select the Custom application ID to be configured for this **QSFP-DD**¹ module.

```

(config-qsfp-dd)#application 15

```

¹QSFP-DD stands for Quad Small Form Factor Pluggable Double Density. QSFP-DD modules provide a scalable, high-bandwidth solution for data center networking, enabling efficient data transmission and network performance in modern computing environments.

```
(config-qsfp-dd)# custom-app-host-id 1
(config-qsfp-dd)# custom-app-media-id 2
(config-qsfp-dd)#commit
```

Validation

```
Port Number                : 0
-----
| User Config | H/W Config
-----
Application | 15 (custom) | 15 (custom)
Host ID     | 1           | 1
Media ID    | 2           | 2
```

Implementation Examples

- Media interface ID bandwidth should be compatible with the host interface ID bandwidth requirements.

- Example of valid combinations:

```
400GAUI-8 <--> ZR400-OFEC-16QAM ==> (1x400G breakout)
200GAUI-4 <--> PKT-MAX-200G-SFEC-60 ==> (1x200G breakout)
100GAUI-2 <--> OTN-STD-100G-OFEC-31 ==> (1x100G breakout)
100GAUI-4 <--> ZR400-OFEC-16QAM ==> (4x100G breakout)
```

- Example of invalid combinations:

```
400GAUI-8 <--> PKT-MAX-200G-SFEC-60
200GAUI-4 <--> OTN-STD-100G-OFEC-31
```

- When host interface ID bandwidth is lower than media interface ID bandwidth, for some cases only one breakout interface is possible.

- Example of valid combinations:

```
100GAUI-2 <--> ZR400-OFEC-16QAM ==> (4x100G breakout is possible)
100GAUI-2 <--> PKT-MAX-200G-SFEC-60 ==> (2x100G breakout is possible)
100CAUI-4 <--> ZR400-OFEC-16QAM ==> (2x100G breakout is possible. Only 2 interfaces because CAUI-4
uses 4 lanes and only 8 lanes are physically available).
```

- Example of invalid combinations.

```
200GAUI-4 <--> ZR400-OFEC-16QAM ==> (2x200G breakout is not possible)
```

Custom Application Advertisement Details

```
OcNOS#show qsfp-dd 0 advertisement applications custom
```

```
Port Number          : 0
Application Selector  : 12
```

```
-----
Host IDs
-----
```

```
Host ID 1:
```

```
Interface           : CAUI-4 C2M without FEC
Application BR       : 103.13
Lane Count           : 4
Lane Sig BR          : 25.78125
Modulation Format     : NRZ
Bits Per Unit Intvl : 1.000000
```

```
Host ID 2:
```

```
Interface           : CAUI-4 C2M with RS FEC
```

```

Application BR      : 103.13
Lane Count         : 4
Lane Sig BR        : 25.78125
Modulation Format   : NRZ
Bits Per Unit Intvl : 1.000000

```

Host ID 3:

```

Interface          : 100GAUI-2 C2M
Application BR     : 106.25
Lane Count        : 2
Lane Sig BR       : 26.5625
Modulation Format   : PAM4
Bits Per Unit Intvl : 2.000000

```

Host ID 4:

```

Interface          : 200GAUI-4 C2M
Application BR     : 212.50
Lane Count        : 4
Lane Sig BR       : 26.5625
Modulation Format   : PAM4
Bits Per Unit Intvl : 2.000000

```

Media IDs

Media ID 1:

```

Interface          : 100G-OFEC-31.5
Application BR     : 100
Lane Count        : 1
Lane Sig BR       : 31.5
Modulation Format   : DP-QPSK
Bits Per Unit Intvl : 4.000000

```

Media ID 2:

```

Interface          : 200G-OFEC-31.5
Application BR     : 200
Lane Count        : 1
Lane Sig BR       : 31.5
Modulation Format   : DP-16QAM
Bits Per Unit Intvl : 8.000000

```

Laser Tuning

Laser Tuning only supports for tunable Transceivers.

Laser Grid Configuration

Use this command to configure the Laser Grids in the **QSFP-DD**¹ port. These commands only supports for modules which supports for laser Tuning Transceivers.

ROUTER1

ROUTER1#configure terminal	Enter configure mode.
ROUTER1 (config)#qsfp-dd 49	Entering to QSFP-DD mode.
ROUTER1 (config-qsfp-dd)#laser grid 100	Configure Laser Grid at QSFP-DD level.
ROUTER1 (config-qsfp-dd)#commit	Commit the configuration.

¹QSFP-DD stands for Quad Small Form Factor Pluggable Double Density. QSFP-DD modules provide a scalable, high-bandwidth solution for data center networking, enabling efficient data transmission and network performance in modern computing environments.

Validation

```

ROUTER-1#show qsfp-dd 49 laser status

Port Number          : 49

-----
Attribute            | Lane | Value  | Unit |
-----
Grid Spacing         | 1    | 100.000 | GHz  |
Laser Frequency      | 1    | 193.100000 | THz  |
Channel Number       | 1    | 0       | --   |
Wavelength           | 1    | 1552.52 | nm   |

-----
Flag                 | Lane | Status |
-----
Tuning in progress  | 1    | No     |
Wavelength locked  | 1    | Yes    |

-----
Flag                 | Lane | Status (L) |
-----
Target output power OOR | 1    | No         |
Fine tuning out of range | 1    | Yes        |
Tuning accepted         | 1    | No         |
Channel number valid    | 1    | No         |
    
```

Laser Grid Unconfiguration

ROUTER1

ROUTER1#configure terminal	Enter configure mode.
ROUTER1 (config)#qsfp-dd 49	Entering to QSFP-DD mode.
ROUTER1 (config-qsfp-dd)#no laser grid	Unconfigure Laser Grid at QSFP-DD level.
ROUTER1 (config-qsfp-dd)#commit	Commit the configuration.

Laser Channel Configuration

Use this command to configure the Laser Channel in the QSFP-DD port. Using Channel Number we can set different Frequency and Wavelength for that port .Every Laser Grid have their own Channel Numbers. These commands only supports for modules which supports for laser Tuning Transceivers.

ROUTER1

ROUTER1#configure terminal	Enter configure mode.
ROUTER1 (config)#qsfp-dd 49	Entering to QSFP-DD mode.
ROUTER1 (config-qsfp-dd)#laser channel 20	Configure Laser Channel at QSFP-DD level.
ROUTER1 (config-qsfp-dd)#commit	Commit the configuration.

Validation

```

ROUTER-1#show qsfp-dd 49 laser status

Port Number          : 49
    
```

```

-----
Attribute      | Lane | Value | Unit |
-----
Grid Spacing   | 1    | 100.000 | GHz |
Laser Frequency | 1    | 195.100000 | THz |
Channel Number | 1    | 20      | --  |
Wavelength    | 1    | 1536.61 | nm  |
-----

```

```

-----
Flag          | Lane | Status |
-----
Tuning in progress | 1    | No     |
Wavelength locked | 1    | Yes    |
-----

```

```

-----
Flag          | Lane | Status (L) |
-----
Target output power OOR | 1    | No         |
Fine tuning out of range | 1    | Yes        |
Tuning accepted          | 1    | Yes        |
Channel number valid     | 1    | No         |
-----

```

Laser Channel Unconfiguration

ROUTER1

ROUTER1#configure terminal	Enter configure mode.
ROUTER1 (config)#qsfp-dd 49	Entering to QSFP-DD mode.
ROUTER1 (config-qsfp-dd)#no laser channel	Unconfigure Laser Channel at QSFP-DD level.
ROUTER1 (config-qsfp-dd)#commit	Commit the configuration.

Laser Fine-tune-freq Configuration

Use this command to configure the Laser fine-tune-freq in the QSFP-DD port. These commands only supports for modules which supports for laser Tuning Transceivers.

ROUTER1

ROUTER1#configure terminal	Enter configure mode.
ROUTER1 (config)#qsfp-dd 49	Entering to QSFP-DD mode.
ROUTER1 (config-qsfp-dd)#laser fine-tune-freq 5	Configure laser fine-tune-freq at QSFP-DD level.
ROUTER1 (config-qsfp-dd)#commit	Commit the configuration.

Validation

```
ROUTER-1#show qsfp-dd 49 laser status
```

```
Port Number      : 49
```

```

-----
Attribute      | Lane | Value | Unit |
-----
Grid Spacing   | 1    | 100.000 | GHz |
Laser Frequency | 1    | 195.104000 | THz |
Channel Number | 1    | 20      | --  |
-----

```

```

Wavelength          | 1 | 1536.58 | nm |
-----
Flag                | Lane | Status |
-----
Tuning in progress | 1 | No |
Wavelength locked  | 1 | Yes |

-----
Flag                | Lane | Status (L) |
-----
Target output power OOR | 1 | No |
Fine tuning out of range | 1 | Yes |
Tuning accepted       | 1 | Yes |
Channel number valid  | 1 | Yes |
    
```

Laser Fine-tune-freq Unconfiguration

ROUTER1

ROUTER1#configure terminal	Enter configure mode.
ROUTER1 (config)#qsfp-dd 49	Entering to QSFP-DD mode.
ROUTER1 (config-qsfp-dd)#no laser fine-tune-freq	Unconfigure laser fine-tune-freq at QSFP-DD level.
ROUTER1 (config-qsfp-dd)#commit	Commit the configuration.

Laser Output-power Configuration

Use this command to configure the Laser output-power in the QSFP-DD port. These commands only supports for modules which supports for laser Tuning Transceivers.

ROUTER1

ROUTER1#configure terminal	Enter configure mode.
ROUTER1 (config)#qsfp-dd 49	Entering to QSFP-DD mode.
ROUTER1 (config-qsfp-dd)#laser output-power 2	Configure laser output-power at QSFP-DD level.
ROUTER1 (config-qsfp-dd)#commit	Commit the configuration.

Validation

```

ROUTER-1#show qsfp-dd 49 laser status

Port Number          : 49

-----
Attribute            | Lane | Value | Unit |
-----
Grid Spacing         | 1 | 100.000 | GHz |
Laser Frequency      | 1 | 195.104000 | THz |
Channel Number       | 1 | 20 | -- |
Wavelength           | 1 | 1536.58 | nm |

-----
Flag                | Lane | Status |
-----
Tuning in progress | 1 | No |
Wavelength locked  | 1 | Yes |
    
```

```

-----
      Flag          | Lane | Status (L) |
-----
Target output power OOR | 1 | No |
Fine tuning out of range | 1 | No |
Tuning accepted         | 1 | Yes |
Channel number valid    | 1 | Yes |
-----
    
```

Laser Output-power Unconfiguration

ROUTER1

ROUTER1#configure terminal	Enter configure mode.
ROUTER1 (config)#qsfp-dd 49	Entering to QSFP-DD mode.
ROUTER1 (config-qsfp-dd)#no laser output-power	Unconfigure laser output-power at QSFP-DD level.
ROUTER1 (config-qsfp-dd)#commit	Commit the configuration.

Laser Grid at Media-lane Configuration

Use this command to configure the Laser Grids in the media-lane. These commands only supports for modules which supports for laser Tuning Transceivers.

ROUTER1

ROUTER1#configure terminal	Enter configure mode.
ROUTER1 (config)#qsfp-dd 49	Entering to QSFP-DD mode.
ROUTER1 (config-qsfp-dd)#media-lane 1	Entering to Media lane ¹ .
ROUTER1 (config-qsfp-dd-media)#laser grid 100	Configure laser grid at Media level.
ROUTER1 (config-qsfp-dd-media)#commit	Commit the configuration.

Validation

```

ROUTER-1#show qsfp-dd 49 laser status

Port Number          : 49

-----
      Attribute      | Lane | Value | Unit |
-----
Grid Spacing         | 1 | 100.000 | GHz |
Laser Frequency      | 1 | 193.100000 | THz |
Channel Number       | 1 | 0 | -- |
Wavelength           | 1 | 1552.52 | nm |
-----

      Flag          | Lane | Status |
-----
Tuning in progress | 1 | No |
Wavelength locked  | 1 | Yes |
-----
    
```

¹Media lanes are the electrical wire pairs (copper cables) or optical fibers that carry signals from the module to the other router and vice-versa.

Flag	Lane	Status (L)
Target output power OOR	1	No
Fine tuning out of range	1	Yes
Tuning accepted	1	No
Channel number valid	1	No

Laser Grid at Media-lane Unconfiguration

ROUTER1 (checker)

ROUTER1#configure terminal	Enter configure mode.
ROUTER1(config)#qsfp-dd 49	Entering to QSFP-DD mode.
ROUTER1(config-qsfp-dd)#media-lane 1	Entering to Media lane.
ROUTER1(config-qsfp-dd-media)#no laser grid	Unconfigure laser grid at Media level.
ROUTER1(config-qsfp-dd-media)#commit	Commit the configuration.

Laser Channel at Media-lane Configuration

Use this command to configure the Laser Channel in the media-lane. Using Channel Number we can set different Frequency and Wavelength for that port .Every Laser Grid have their own Channel Numbers. These commands only supports for modules which supports for laser Tuning Transceivers.

ROUTER1

ROUTER1#configure terminal	Enter configure mode.
ROUTER1(config)#qsfp-dd 49	Entering to QSFP-DD mode.
ROUTER1(config-qsfp-dd)#media-lane 1	Entering to Media lane.
ROUTER1(config-qsfp-dd-media)#laser channel 20	Configure laser channel at Media level.
ROUTER1(config-qsfp-dd-media)#commit	Commit the configuration.

Validation

```
ROUTER-1#show qsfp-dd 49 laser status

Port Number      : 49

-----
Attribute        | Lane | Value   | Unit |
-----
Grid Spacing     | 1    | 100.000 | GHz  |
Laser Frequency  | 1    | 195.100000 | THz  |
Channel Number   | 1    | 20      | --   |
Wavelength       | 1    | 1536.61 | nm   |

-----
Flag             | Lane | Status |
-----
Tuning in progress | 1    | No     |
Wavelength locked | 1    | Yes    |

-----
Flag             | Lane | Status (L) |
```

```

-----
Target output power OOR | 1 | No |
Fine tuning out of range | 1 | Yes |
Tuning accepted         | 1 | Yes |
Channel number valid    | 1 | No |
    
```

Laser Channel at Media-lane Unconfiguration

ROUTER1

ROUTER1#configure terminal	Enter configure mode.
ROUTER1 (config)#qsfp-dd 49	Entering to QSFP-DD mode.
ROUTER1 (config-qsfp-dd)#media-lane 1	Entering to Media lane.
ROUTER1 (config-qsfp-dd-media)#no laser channel	Unconfigure laser channel at Media level.
ROUTER1 (config-qsfp-dd-media)#commit	Commit the configuration.

Laser Fine-tune-freq at Media-lane Configuration

Use this command to configure the Laser fine-tune-freq in the media-lane. These commands only supports for modules which supports for laser Tuning Transceivers.

ROUTER1

ROUTER1#configure terminal	Enter configure mode.
ROUTER1 (config)#qsfp-dd 49	Entering to QSFP-DD mode.
ROUTER1 (config-qsfp-dd)#media-lane 1	Entering to Media lane.
ROUTER1 (config-qsfp-dd-media)#laser fine-tune-freq 5	Configure laser fine-tune-freq at Media level.
ROUTER1 (config-qsfp-dd-media)#commit	Commit the configuration.

Validation

```

ROUTER-1#show qsfp-dd 49 laser status

Port Number      : 49

-----
Attribute        | Lane | Value  | Unit |
-----
Grid Spacing     | 1    | 100.000 | GHz  |
Laser Frequency  | 1    | 195.104000 | THz  |
Channel Number   | 1    | 20      | --   |
Wavelength       | 1    | 1536.58 | nm   |

-----
Flag             | Lane | Status |
-----
Tuning in progress | 1    | No     |
Wavelength locked | 1    | Yes    |

-----
Flag             | Lane | Status (L) |
-----
Target output power OOR | 1    | No     |
Fine tuning out of range | 1    | Yes    |
    
```

```
Tuning accepted      | 1 | Yes |
Channel number valid | 1 | Yes |
```

Laser Fine-tune-freq at Media-lane Unconfiguration

ROUTER1

ROUTER1#configure terminal	Enter configure mode.
ROUTER1 (config)#qsfp-dd 49	Entering to QSFP-DD mode.
ROUTER1 (config-qsfp-dd)#media-lane 1	Entering to Media lane.
ROUTER1 (config-qsfp-dd-media)#no laser fine-tune-freq	Unconfigure laser fine-tune-freq at Media level.
ROUTER1 (config-qsfp-dd-media)#commit	Commit the configuration.

Laser Output-power at Media-lane Configuration

Use this command to configure the Laser output-power in the media-lane. These commands only supports for modules which supports for laser Tuning Transceivers.

ROUTER1

ROUTER1#configure terminal	Enter configure mode.
ROUTER1 (config)#qsfp-dd 49	Entering to QSFP-DD mode.
ROUTER1 (config-qsfp-dd)#media-lane 1	Entering to Media lane.
ROUTER1 (config-qsfp-dd-media)#laser output-power 2	Configure laser output-power at Media level.
ROUTER1 (config-qsfp-dd-media)#commit	Commit the configuration.

Validation

```
ROUTER-1#show qsfp-dd 49 laser status

Port Number      : 49

-----
Attribute      | Lane | Value  | Unit |
-----
Grid Spacing   | 1    | 100.000 | GHz  |
Laser Frequency | 1    | 195.104000 | THz  |
Channel Number | 1    | 20      | --   |
Wavelength     | 1    | 1536.58 | nm   |

-----
Flag           | Lane | Status |
-----
Tuning in progress | 1    | No     |
Wavelength locked | 1    | Yes    |

-----
Flag           | Lane | Status (L) |
-----
Target output power OOR | 1    | No         |
Fine tuning out of range | 1    | No         |
Tuning accepted      | 1    | Yes        |
Channel number valid | 1    | Yes        |
```

Laser Output-power at Media-lane Unconfiguration

ROUTER1

ROUTER1#configure terminal	Enter configure mode.
ROUTER1 (config)#qsfp-dd 49	Entering to QSFP-DD mode.
ROUTER1 (config-qsfp-dd)#media-lane 1	Entering to Media lane.
ROUTER1 (config-qsfp-dd-media)#no laser output-power	Unconfigure laser output-power at Media level.
ROUTER1 (config-qsfp-dd-media)#commit	Commit the configuration.

QSFP-DD Monitored Alarms

Table 69. QSFP-DD¹ Monitored Alarms

Alarms	
Module	
S.No.	Name
1	Temperature
2	Voltage
3	TEC Current Magnitude
4	Laser temperature
Host	
S.No.	Name
1	Tx LOS
2	Tx Cdr Loss of Lock
3	Tx Adapttive Eq Failure
4	Rx Output Status
5	FEC² Excessive Degrade(FED³)
6	FEC Detected Degrade(FDD⁴)
7	Remote Degrade
8	Local Degrade
9	Flexe Loss of pad block
10	Flexe loss of Multiframe

¹QSFP-DD stands for Quad Small Form Factor Pluggable Double Density. QSFP-DD modules provide a scalable, high-bandwidth solution for data center networking, enabling efficient data transmission and network performance in modern computing environments.

²FEC is a technique that detects and corrects errors during data transmission to maintain the reliability of the communication system.

³FEC Excessive Degrade suggests that the FEC has detected very high errors in data transmission. FED is a more severe error condition than FDD and needs more attention. The alarm notification is triggered if the average BER exceeds the configured FED value.

⁴FEC Detected Degrade suggests that the FEC has detected errors in data transmission. The alarm notification is triggered if the average BER exceeds the configured FDD value.

Alarms	
11	Flexe loss of frame
12	Flexe instance ID mismatch
13	Flexe calender mismatch
14	Flexe instance map mismatch
15	Flexe GID mismatch
16	Tx local fault
17	Tx remote fault
18	Tx loss of alignment
19	Rx local fault
20	Rx remote fault
21	Rx loss of alignment
Media	
S.No.	Name
1	Rx Optical Power
2	Tx Optical Power
3	Tx Bias
4	Rx LOS
5	Rx Cdr Loss of Lock
6	Tx Failure
7	Tx Output Status
8	Tx FIFO error alarm
9	Tx Deskew Loss of Lock alarm
10	Tx Reference Clock Loss of Lock alarm
11	Tx CMU Loss of Lock alarm
12	Tx Out of Alignment alarm
13	Tx Loss of Alignment alarm
14	Rx FIFO Loss of Lock alarm
15	Rx Deskew Loss of Lock alarm
16	Rx Out of Alignment alarm
17	Rx Loss of Alignment alarm
18	Rx Chromatic Dispersion Compensation Loss of Lock alarm
19	Rx Demodulator Loss of Lock alarm
20	Rx Loss of Multi Frame alarm
21	Rx Loss of Frame alarm

Alarms	
22	Remote PHY Fault alarm
23	Local Degrade alarm
24	Remote Degrade alarm
25	FEC Detected Degrade over PM Interval alarm
26	FEC Excessive Degrade over PM Interval alarm
27	Laser Age
28	Laser Frequency Error

Table 70.

Performance Monitoring	
Host	
S.No.	Name
1	eSNR Input
2	PAM4 Level Trans
3	Pre-FEC BER
4	FERC
5	Tx Bits & Corrected Bits
6	Tx Frames & Uncorrected Frames
Media	
S.No.	Name
1	eSNR Input
2	PAM4 Level Trans
3	Pre-FEC BER
4	FERC
5	Mod Bias X/I
6	Mod Bias X/Q
7	Mod Bias Y/I
8	Mod Bias Y/Q
9	Mod Bias X_Phase
10	Mod Bias Y_Phase
11	CD - HG Short link
12	CD - LG Long link
13	DGD
14	SOPMD - HG

Table 70. (continued)

Performance Monitoring	
15	PDL
16	OSNR
17	eSNR
18	CFO
19	EVM_modem
20	Tx Power
21	Rx Total Power
22	Rx Sig Power
23	SOP ROC
24	MER
25	Clk recovery loop
26	SOPMD - LG
27	Rx Bits & Corrected Bits
28	Rx Frames & Uncorrected Frames

Example

Given a few examples of Alarms.

For Rx Optical Power & Rx Los:

```

2023 May 25 18:23:20.545 : OcNOS : NSM : CRITI : [IFMGR_IF_DOWN_2]: Interface cd52 changed state to
down
2023 May 25 18:23:24.116 : OcNOS : CMM : CRITI : [CMM_CMIS_MODULE_MONITOR_2]: Rx Optical Power[Low
Alarm] detected on Lane[1] Port[52] module. Reading[100.000 dBm], Threshold[-28.239 dBm]. Vendor
[SmartOptics      ] Serial[214156190      ]

2023 May 25 18:23:24.164 : OcNOS : CMM : CRITI : [CMM_CMIS_MODULE_MONITOR_2]: Rx LOS detected on Lane
[1] Port[52] module. Vendor[SmartOptics      ] Serial[214156190      ]
OcNOS#sh qsfm-dd 52 monitors media

Alarm Codes: TFIFO - Tx FIFO Error, TLOLDS - Tx Deskew Loss of Lock
TLOLRC - Tx Reference Clock Loss of Lock, TLOLCMU - Tx CMU Loss of Lock
TOOA - Tx Out of Alignment, TLOA - Tx Loss of Alignment
RFIFO - Rx FIFO Error, RLOLDS - Tx Deskew Loss of Lock
ROOA - Rx Out of Alignment, RLOA - Rx Loss of Alignment
RLOLCD - Rx Chromatic Dispersion Compensation Loss of Lock
RLOLD - Tx Demodulator Loss of Lock, RLOM - Rx Loss of Multi Frame
RLOF - Rx Loss of Frame, FDD - FEC Detected Degrade
FED - FEC Excessive Degrade, RPF - Remote Phy Fault
LD - Local Degrade, RD - Remote Degrade

Codes: [HA : High Alarm], [LA : Low Alarm], [HW : High Warning], [LW : Low Warning]

Port Number          : 52
-----
Monitors              | Lane | Value          | High Alarm | High Warning | Low Warning | Low
Alarm | Unit |
-----
Rx Optical Power      | 1    | -- [LA] | 2.0        | 0.0          | -23.0       | -
28.2                  | dBm  |

```

```

Tx Optical Power      | 1 | -7.4 | 0.0 | -2.0 | -16.0 | -
18.0 | dBm |
Tx Bias               | 1 | 293.6 | 0.0 | 0.0 | 0.0 | 0.0
| mA |
    
```

```

-----
VDM | Lane | Value | High Alarm | High Warning | Low Warning | Low
Alarm | Unit |
    
```

```

-----
Laser Age
[DP]| 1 | 0.0 | 65534.0 | 58983.0 | 0.0 | 0.0 | % |
Pre-FEC BER Min In[DP]| 1 | 5.00e-01 | 2.05e+10 | 2.05e+10 | 0.00e+00 | 0.00e+00 | NA |
Pre-FEC BER Max In[DP]| 1 | 5.00e-01 | 2.05e+10 | 2.05e+10 | 0.00e+00 | 0.00e+00 | NA |
Pre-FEC BER Avg In[DP]| 1 | 5.00e-01 | 2.05e+10 | 2.05e+10 | 0.00e+00 | 0.00e+00 | NA |
Pre-FEC BER Cur In[DP]| 1 | 5.00e-01 | 2.05e+10 | 2.05e+10 | 0.00e+00 | 0.00e+00 | NA |
FERC Min Input
[DP]| 1 | 0.00e+00 | 2.05e+10 | 2.05e+10 | 0.00e+00 | 0.00e+00 | NA |
FERC Max Input
[DP]| 1 | 0.00e+00 | 2.05e+10 | 2.05e+10 | 0.00e+00 | 0.00e+00 | NA |
FERC Avg Input
[DP]| 1 | 0.00e+00 | 2.05e+10 | 2.05e+10 | 0.00e+00 | 0.00e+00 | NA |
FERC Curr Input
[DP]| 1 | 0.00e+00 | 2.05e+10 | 2.05e+10 | 0.00e+00 | 0.00e+00 | NA |
Mod Bias X/I
[DP]| 1 | 38.0 | 89.0 | 84.0 | 14.0 | 4.0 | % |
Mod Bias X/Q
[DP]| 1 | 39.0 | 89.0 | 84.0 | 14.0 | 4.0 | % |
Mod Bias Y/I
[DP]| 1 | 43.0 | 89.0 | 84.0 | 14.0 | 4.0 | % |
Mod Bias Y/Q
[DP]| 1 | 41.0 | 89.0 | 84.0 | 14.0 | 4.0 | % |
Mod Bias X_Phase
[DP]| 1 | 34.0 | 89.0 | 84.0 | 14.0 | 4.0 | % |
Mod Bias Y_Phase
[DP]| 1 | 42.0 | 89.0 | 84.0 | 14.0 | 4.0 | % |
CD - HG Short link[DP]| 1 | 0.0 | 0.0 | -1.0 | -
1.0 | 0.0 | Ps/nm |
CD - LG Long link [DP]| 1 | 0.0 | 0.0 | -20.0 | -
20.0 | 0.0 | Ps/nm |
DGD
[DP]| 1 | 0.0 | 655.3 | 655.3 | 0.0 | 0.0 | Ps |
SOPMD - HG
[DP]| 1 | 0.0 | 655.3 | 655.3 | 0.0 | 0.0 | Ps^2 |
PDL
[DP]| 1 | 0.0 | 6553.5 | 6553.5 | 0.0 | 0.0 | dB |
OSNR
[DP]| 1 | 0.0 | 6553.5 | 6553.5 | 0.0 | 0.0 | dB |
eSNR
[DP]| 1 | 0.0 | 6553.5 | 6553.5 | 0.0 | 0.0 | dB |
CFO [DP]| 1 | 0.0 | 0.0 | -1.0 | -
1.0 | 0.0 | MHz |
Tx Power [DP]| 1 | -7.4 | 0.0 | -2.0 | -16.0 | -
18.0 | dBm |
Rx Total Power [DP]| 1 | -46.5 | 13.0 | 10.0 | -18.0 | -
21.0 | dBm |
Rx Sig Power [DP]| 1 | -40.0 | 13.0 | 10.0 | -18.0 | -
21.0 | dBm |
SOP ROC
[DP]| 1 | 0.0 | 65535.0 | 65535.0 | 0.0 | 0.0 | krad/s |
SOPMD - LG
[DP]| 1 | 0.0 | 0.0 | 0.0 | 0.0 | 0.0 | Ps^2 |
    
```

```

-----
Flag | Lane | Status (L) |
    
```



```
Rx LOS           | 1 | True |
Tx Failure      | 1 | False |
Rx CDR LOL     | 1 | True |
```

Link Performance	Lane	Average	Minimum	Maximum	Unit
Rx DSP CCD	1	0	0	0	ps/nm
Rx DSP DGD	1	0.00	0.00	0.00	ps
Rx Low Granularity SOPMD	1	0.0	0.0	0.0	ps^2
Rx PDL	1	0.0	0.0	0.0	dB
Rx OSNR	1	0.0	0.0	0.0	dB
Rx ESNR	1	0.0	0.0	0.0	dB
Rx CFO	1	0	0	0	MHz
Tx Power	1	-7.44	-7.44	-7.43	dBm
Rx Input Optical Power	1	-48.18	-50.30	-44.67	dBm
Rx Input Optical Signal Power	1	-40.00	-40.00	-40.00	dBm
Rx SOPCR	1	0	0	0	krads/s
Rx MER	1	0.0	0.0	0.0	dB

FEC Performance	Lane	Value
Rx Bits	1	0
Rx Corrected Bits	1	0
Rx Frames	1	0
Rx Uncorrected Frames	1	0

For TX LOS & TX Cdr Loss:

```
2023 May 25 18:45:39.031 : OcNOS : NSM : CRITI : [IFMGR_IF_DOWN_2]: Interface cd0 changed state to
down
OcNOS(config-if)#2023 May 25 18:45:40.340 : OcNOS : CMM : CRITI : [CMM_CMIS_MODULE_MONITOR_2]: Tx LOS
detected on Lane[1] Port[0] module. Vendor[SmartOptics ] Serial[214156344 ]

2023 May 25 18:45:40.349 : OcNOS : CMM : CRITI : [CMM_CMIS_MODULE_MONITOR_2]: Tx Cdr Loss of Lock
detected on Lane[1] Port[0] module. Vendor[SmartOptics ] Serial[214156344 ]

2023 May 25 18:45:40.373 : OcNOS : CMM : CRITI : [CMM_CMIS_MODULE_MONITOR_2]: Tx LOS detected on Lane
[2] Port[0] module. Vendor[SmartOptics ] Serial[214156344 ]

2023 May 25 18:45:40.381 : OcNOS : CMM : CRITI : [CMM_CMIS_MODULE_MONITOR_2]: Tx Cdr Loss of Lock
detected on Lane[2] Port[0] module. Vendor[SmartOptics ] Serial[214156344 ]

2023 May 25 18:45:40.406 : OcNOS : CMM : CRITI : [CMM_CMIS_MODULE_MONITOR_2]: Tx LOS detected on Lane
[3] Port[0] module. Vendor[SmartOptics ] Serial[214156344 ]

2023 May 25 18:45:40.414 : OcNOS : CMM : CRITI : [CMM_CMIS_MODULE_MONITOR_2]: Tx Cdr Loss of Lock
detected on Lane[3] Port[0] module. Vendor[SmartOptics ] Serial[214156344 ]

2023 May 25 18:45:40.438 : OcNOS : CMM : CRITI : [CMM_CMIS_MODULE_MONITOR_2]: Tx LOS detected on Lane
[4] Port[0] module. Vendor[SmartOptics ] Serial[214156344 ]

2023 May 25 18:45:40.446 : OcNOS : CMM : CRITI : [CMM_CMIS_MODULE_MONITOR_2]: Tx Cdr Loss of Lock
detected on Lane[4] Port[0] module. Vendor[SmartOptics ] Serial[214156344 ]

2023 May 25 18:45:40.471 : OcNOS : CMM : CRITI : [CMM_CMIS_MODULE_MONITOR_2]: Tx LOS detected on Lane
[5] Port[0] module. Vendor[SmartOptics ] Serial[214156344 ]

2023 May 25 18:45:40.478 : OcNOS : CMM : CRITI : [CMM_CMIS_MODULE_MONITOR_2]: Tx Cdr Loss of Lock
detected on Lane[5] Port[0] module. Vendor[SmartOptics ] Serial[214156344 ]

2023 May 25 18:45:40.503 : OcNOS : CMM : CRITI : [CMM_CMIS_MODULE_MONITOR_2]: Tx LOS detected on Lane
[6] Port[0] module. Vendor[SmartOptics ] Serial[214156344 ]

2023 May 25 18:45:40.511 : OcNOS : CMM : CRITI : [CMM_CMIS_MODULE_MONITOR_2]: Tx Cdr Loss of Lock
detected on Lane[6] Port[0] module. Vendor[SmartOptics ] Serial[214156344 ]
```

```

2023 May 25 18:45:40.535 : OcNOS : CMM : CRITI : [CMM_CMIS_MODULE_MONITOR_2]: Tx LOS detected on Lane
[7] Port[0] module. Vendor[SmartOptics      ] Serial[214156344      ]

2023 May 25 18:45:40.543 : OcNOS : CMM : CRITI : [CMM_CMIS_MODULE_MONITOR_2]: Tx Cdr Loss of Lock
detected on Lane[7] Port[0] module. Vendor[SmartOptics      ] Serial[214156344      ]

2023 May 25 18:45:40.568 : OcNOS : CMM : CRITI : [CMM_CMIS_MODULE_MONITOR_2]: Tx LOS detected on Lane
[8] Port[0] module. Vendor[SmartOptics      ] Serial[214156344      ]

2023 May 25 18:45:40.575 : OcNOS : CMM : CRITI : [CMM_CMIS_MODULE_MONITOR_2]: Tx Cdr Loss of Lock
detected on Lane[8] Port[0] module. Vendor[SmartOptics      ] Serial[214156344      ]
    
```

```

OcNOS(config-if)#end
OcNOS#show qsfp-dd 0 monitors host
    
```

```

Alarm Codes: FDD - FEC Detected Degrade, FED - FEC Excessive Degrade
              LD - Local Degrade, RD - Remote Degrade
              FLOPB - Flexe Loss of Pad Block, FLOMF - Flexe Loss of Multi-Frame
              FLOF - Flexe Loss of Frame, FIIDM - Flexe Instance Id Mismatch
              FCM - Flexe Calendar Mismatch, FIMM - Flexe Instance Map Mismatch
              FGIDM - Flexe GID Mismatch, TLF - Transmit Local Fault
              TRF - Transmit Remote Fault, TLOA - Transmit Loss of Alignment
              RLF - Receive Local Fault, RRF - Receive Remote Fault
              RLOA - Receive Loss of Alignment
    
```

```

Port Number          : 0
-----
      Flag          | Lane |   Status (L)   |
-----
Tx LOS              |  1  |   True         |
                  |  2  |   True         |
                  |  3  |   True         |
                  |  4  |   True         |
                  |  5  |   True         |
                  |  6  |   True         |
                  |  7  |   True         |
                  |  8  |   True         |
Tx CDR LOL          |  1  |   True         |
                  |  2  |   True         |
                  |  3  |   True         |
                  |  4  |   True         |
                  |  5  |   True         |
                  |  6  |   True         |
                  |  7  |   True         |
                  |  8  |   True         |
Tx Adaptive Input Eq |  1  |   Good         |
                  |  2  |   Good         |
                  |  3  |   Good         |
                  |  4  |   Good         |
                  |  5  |   Good         |
                  |  6  |   Good         |
                  |  7  |   Good         |
                  |  8  |   Good         |
    
```

```

-----
VDM          | Lane | Value          | High Alarm | High Warning | Low Warning | Low
Alarm | Unit |
-----
Pre-FEC BER Min In
[DP]| 1 | 1.00e+00 | 2.05e+10 | 2.05e+10 | 0.00e+00 | 0.00e+00 | NA |
Pre-FEC BER Max In
[DP]| 1 | 0.00e+00 | 2.05e+10 | 2.05e+10 | 0.00e+00 | 0.00e+00 | NA |
Pre-FEC BER Avg In
[DP]| 1 | 0.00e+00 | 2.05e+10 | 2.05e+10 | 0.00e+00 | 0.00e+00 | NA |
Pre-FEC BER Cur In[DP]| 1 | 5.00e-01 | 2.05e+10 | 2.05e+10 | 0.00e+00 | 0.00e+00 | NA |
    
```

```

FERC Min Input
[DP]| 1 | 0.00e+00 | 2.05e+10 | 2.05e+10 | 0.00e+00 | 0.00e+00 | NA |
FERC Max Input
[DP]| 1 | 0.00e+00 | 2.05e+10 | 2.05e+10 | 0.00e+00 | 0.00e+00 | NA |
FERC Avg Input
[DP]| 1 | 0.00e+00 | 2.05e+10 | 2.05e+10 | 0.00e+00 | 0.00e+00 | NA |
FERC Curr Input
[DP]| 1 | 0.00e+00 | 2.05e+10 | 2.05e+10 | 0.00e+00 | 0.00e+00 | NA |

```

```

-----
FEC Performance | Lane | Value |
-----
Tx Bits         | 1   | 0     |
Tx Corrected Bits | 1   | 0     |
Tx Frames       | 1   | 0     |
Tx Uncorrected Frames | 1   | 0     |

```

Remote Fault and Local Fault Alarms

Overview

Local Fault: A local fault occurs when there is an issue with the line port, indicating a problem detected at the local end, such as bad data or signal.

Remote Fault: A remote fault is triggered when a port receives a remote fault frame from the far end (the port experiencing the local fault).

To address these faults, perform the "Shut/No Shut" operation at the interface level after enabling logging levels on the DUT (Device Under Test). Configure the "create-subscription" in the Netconf terminal, and to generate SNMP traps, connect the DUT to an MIB browser or a Linux server. Once configured, the "Shut" operation can be executed to generate alarms, and the "No Shut" operation can be used to recover from those alarms. Below, we have highlighted some alarms and their corresponding recovery processes in CLMSH mode, Netconf mode, and via SNMP traps.

Validation

Perform the Shut operation on the interface level to generate the alarms. To validate the remote fault and local fault alarms, use the following commands.

```
Ocnos#con t
```

Enter configuration commands, one per line. End with CNTL/Z.

```

Ocnos(config)#int cd1
Ocnos(config-if)#shutdown
Ocnos (config-if)#commit

2024 Sep 01 22:30:33.527 : OCNOS : NSM : CRITI : [IFMGR_IF_DOWN_2]: Interface cd1 changed state to
down --> Interface went to down state
2024 Sep 01 22:30:33.580 : OCNOS : CMM : CRITI : [CMM_CMIS_MODULE_HOST_LANE_MONITOR_2]: Tx LOS
detected on Lane[6] Port[1] module. Vendor[CIENA ] Serial[Q00JF7FD ]

OCNOS(config-if)#2024 Sep 01 22:30:34.816 : OCNOS : CMM : CRITI : [CMM_CMIS_MODULE_HOST_LANE_MONITOR_
2]: Tx LOS detected on Lane[7] Port[1] module. Vendor[CIENA ] Serial[Q00JF7FD ]

2024 Sep 01 22:30:43.250 : OCNOS : CMM : CRITI : [CMM_CMIS_MODULE_HOST_LANE_MONITOR_2]: Tx LOS
detected on Lane[1] Port[1] module. Vendor[CIENA ] Serial[Q00JF7FD ]

2024 Sep 01 22:30:44.363 : OCNOS : CMM : CRITI : [CMM_CMIS_MODULE_HOST_LANE_MONITOR_2]: Tx Loss of
Alignment detected on Lane[1] Port[1] module. Vendor[CIENA ] Serial[Q00JF7FD ]

```

```
2024 Sep 01 22:30:44.363 : OCNOS : CMM : CRITI : [CMM_CMIS_MODULE_HOST_LANE_MONITOR_2]: Tx Local
Fault detected on Lane[1] Port[1] module. Vendor[CIENA ] Serial[Q00JF7FD ] --> Here
we can see the Local fault alarm.

2024 Sep 01 22:30:44.363 : OCNOS : CMM : CRITI : [CMM_CMIS_MODULE_HOST_LANE_MONITOR_2]: Rx Remote
Fault detected on Lane[1] Port[1] module. Vendor[CIENA ] Serial[Q00JF7FD ] --> Here
we can see the Remote fault alarm.

2024 Sep 01 22:30:44.364 : OCNOS : CMM : CRITI : [CMM_CMIS_MODULE_HOST_LANE_MONITOR_2]: Pre-FEC BER
Current Sample Input[High Alarm] detected on Lane[1] Port[1] module. Reading[0.000 1e-6], Threshold
[239.000 1e-6]. Vendor[CIENA ] Serial[Q00JF7FD ]

2024 Sep 01 22:30:44.364 : OCNOS : CMM : NOTIF : [CMM_CMIS_MODULE_HOST_LANE_MONITOR_4]: Pre-FEC BER
Current Sample Input[High Warning] detected on Lane[1] Port[1] module. Reading[0.000 1e-6], Threshold
[43.800 1e-6]. Vendor[CIENA ] Serial[Q00JF7FD ]

2024 Sep 01 22:30:44.364 : OCNOS : CMM : CRITI : [CMM_CMIS_MODULE_HOST_LANE_MONITOR_2]: FERC Maximum
Sample Value Input[High Alarm] detected on Lane[1] Port[1] module. Reading[0.000 1e-6], Threshold
[500000.000 1e-6]. Vendor[CIENA ] Serial[Q00JF7FD ]

2024 Sep 01 22:30:44.364 : OCNOS : CMM : NOTIF : [CMM_CMIS_MODULE_HOST_LANE_MONITOR_4]: FERC Maximum
Sample Value Input[High Warning] detected on Lane[1] Port[1] module. Reading[0.000 1e-6], Threshold
[500000.000 1e-6]. Vendor[CIENA ] Serial[Q00JF7FD ]

2024 Sep 01 22:30:44.364 : OCNOS : CMM : CRITI : [CMM_CMIS_MODULE_HOST_LANE_MONITOR_2]: FERC Sample
Average Value Input[High Alarm] detected on Lane[1] Port[1] module. Reading[0.000 1e-6], Threshold
[500000.000 1e-6]. Vendor[CIENA ] Serial[Q00JF7FD ]

2024 Sep 01 22:30:44.364 : OCNOS : CMM : NOTIF : [CMM_CMIS_MODULE_HOST_LANE_MONITOR_4]: FERC Sample
Average Value Input[High Warning] detected on Lane[1] Port[1] module. Reading[0.000 1e-6], Threshold
[500000.000 1e-6]. Vendor[CIENA ] Serial[Q00JF7FD ]

2024 Sep 01 22:30:44.364 : OCNOS : CMM : CRITI : [CMM_CMIS_MODULE_HOST_LANE_MONITOR_2]: FERC Current
Sample Value Input[High Alarm] detected on Lane[1] Port[1] module. Reading[0.000 1e-6], Threshold
[500000.000 1e-6]. Vendor[CIENA ] Serial[Q00JF7FD ]

2024 Sep 01 22:30:44.365 : OCNOS : CMM : NOTIF : [CMM_CMIS_MODULE_HOST_LANE_MONITOR_4]: FERC Current
Sample Value Input[High Warning] detected on Lane[1] Port[1] module. Reading[0.000 1e-6], Threshold
[500000.000 1e-6]. Vendor[CIENA ] Serial[Q00JF7FD ]

2024 Sep 01 22:30:44.497 : OCNOS : CMM : CRITI : [CMM_CMIS_MODULE_HOST_LANE_MONITOR_2]: Tx LOS
detected on Lane[2] Port[1] module. Vendor[CIENA ] Serial[Q00JF7FD ]

2024 Sep 01 22:30:44.797 : OCNOS : CMM : NOTIF : [CMM_CMIS_MODULE_HOST_LANE_MONITOR_4]: Tx LOS
recovered on Lane[7] Port[1] module. Vendor[CIENA ] Serial[Q00JF7FD ]

2024 Sep 01 22:30:44.849 : OCNOS : CMM : CRITI : [CMM_CMIS_MODULE_HOST_LANE_MONITOR_2]: Tx LOS
detected on Lane[8] Port[1] module. Vendor[CIENA ] Serial[Q00JF7FD ]

Ocnos (config-if)#2024 Sep 01 22:30:54.371 : OCNOS : CMM : NOTIF : [CMM_CMIS_MODULE_HOST_LANE_MONITOR_
4]: FERC Maximum Sample Value Input[High Alarm] recovered on Port[1] module. Reading[0.000 1e-6],
Threshold[500000.000 1e-6]. Vendor[CIENA ] Serial[Q00JF7FD ]

2024 Sep 01 22:30:54.371 : OCNOS : CMM : NOTIF : [CMM_CMIS_MODULE_HOST_LANE_MONITOR_4]: FERC Maximum
Sample Value Input[High Warning] recovered on Port[1] module. Reading[0.000 1e-6], Threshold
[500000.000 1e-6]. Vendor[CIENA ] Serial[Q00JF7FD ]

2024 Sep 01 22:30:54.371 : OCNOS : CMM : NOTIF : [CMM_CMIS_MODULE_HOST_LANE_MONITOR_4]: FERC Sample
Average Value Input[High Alarm] recovered on Port[1] module. Reading[0.000 1e-6], Threshold
[500000.000 1e-6]. Vendor[CIENA ] Serial[Q00JF7FD ]

2024 Sep 01 22:30:54.371 : OCNOS : CMM : NOTIF : [CMM_CMIS_MODULE_HOST_LANE_MONITOR_4]: FERC Sample
Average Value Input[High Warning] recovered on Port[1] module. Reading[0.000 1e-6], Threshold
[500000.000 1e-6]. Vendor[CIENA ] Serial[Q00JF7FD ]

Ocnos (config-if)#2024 Sep 01 22:30:54.596 : OCNOS : CMM : CRITI : [CMM_CMIS_MODULE_HOST_LANE_
MONITOR_2]: Tx LOS detected on Lane[4] Port[1] module. Vendor[CIENA ] Serial
[Q00JF7FD ]

2024 Sep 01 22:30:54.845 : OCNOS : CMM : NOTIF : [CMM_CMIS_MODULE_HOST_LANE_MONITOR_4]: Tx LOS
recovered on Lane[8] Port[1] module. Vendor[CIENA ] Serial[Q00JF7FD ]
```

Here we are going to perform the NO Shut operation on the interface level to recover the alarms.

```
Ocnos (config-if)#no shutdown
Ocnos (config-if)#commit
```

```
2024 Sep 01 22:31:04.538 : OCNOS : CMM : NOTIF : [CMM_CMIS_MODULE_HOST_LANE_MONITOR_4]: Tx LOS
recovered on Lane[2] Port[1] module. Vendor[CIENA ] Serial[Q00JF7FD ]
```

```
2024 Sep 01 22:31:04.683 : OCNOS : CMM : NOTIF : [CMM_CMIS_MODULE_HOST_LANE_MONITOR_4]: Tx LOS
recovered on Lane[4] Port[1] module. Vendor[CIENA ] Serial[Q00JF7FD ]
```

```
2024 Sep 01 22:31:04.788 : OCNOS : CMM : NOTIF : [CMM_CMIS_MODULE_HOST_LANE_MONITOR_4]: Tx LOS
recovered on Lane[6] Port[1] module. Vendor[CIENA ] Serial[Q00JF7FD ]
```

```
2024 Sep 01 22:31:14.372 : OCNOS : CMM : NOTIF : [CMM_CMIS_MODULE_HOST_LANE_MONITOR_4]: Tx LOS
recovered on Lane[1] Port[1] module. Vendor[CIENA ] Serial[Q00JF7FD ]
```

```
2024 Sep 01 22:31:14.511 : OCNOS : CMM : NOTIF : [CMM_CMIS_MODULE_HOST_LANE_MONITOR_4]: Tx Local
Fault recovered on Lane[1] Port[1] module. Vendor[CIENA ] Serial[Q00JF7FD ] --> Here
we can see that alarm is getting recovered.
```

```
2024 Sep 01 22:31:14.511 : OCNOS : CMM : NOTIF : [CMM_CMIS_MODULE_HOST_LANE_MONITOR_4]: Tx Remote
Fault recovered on Lane[1] Port[1] module. Vendor[CIENA ] Serial[Q00JF7FD ] --> Here
we can see that alarm is getting recovered.
```

```
2024 Sep 01 22:31:18.535 : OCNOS : NSM : CRITI : [IFMGR_IF_UP_2]: Interface cdl changed state to up -
-> Here we can see that interface came UP.
```

```
2024 Sep 01 22:31:33.387 : OCNOS : CMM : NOTIF : [CMM_CMIS_MODULE_HOST_LANE_MONITOR_4]: Tx Loss of
Alignment recovered on Lane[1] Port[1] module. Vendor[CIENA ] Serial[Q00JF7FD ]
```

```
2024 Sep 01 22:31:33.387 : OCNOS : CMM : NOTIF : [CMM_CMIS_MODULE_HOST_LANE_MONITOR_4]: Rx Remote
Fault recovered on Lane[1] Port[1] module. Vendor[CIENA ] Serial[Q00JF7FD ]
```

```
2024 Sep 01 22:31:33.387 : OCNOS : CMM : NOTIF : [CMM_CMIS_MODULE_HOST_LANE_MONITOR_4]: Pre-FEC BER
Current Sample Input[High Alarm] recovered on Port[1] module. Reading[0.001 1e-6], Threshold[239.000
1e-6]. Vendor[CIENA ] Serial[Q00JF7FD ]
```

```
2024 Sep 01 22:31:33.387 : OCNOS : CMM : NOTIF : [CMM_CMIS_MODULE_HOST_LANE_MONITOR_4]: Pre-FEC BER
Current Sample Input[High Warning] recovered on Port[1] module. Reading[0.001 1e-6], Threshold[43.800
1e-6]. Vendor[CIENA ] Serial[Q00JF7FD ]
```

```
2024 Sep 01 22:31:33.387 : OCNOS : CMM : NOTIF : [CMM_CMIS_MODULE_HOST_LANE_MONITOR_4]: FERC Current
Sample Value Input[High Alarm] recovered on Port[1] module. Reading[0.000 1e-6], Threshold[500000.000
1e-6]. Vendor[CIENA ] Serial[Q00JF7FD ]
```

```
2024 Sep 01 22:31:33.388 : OCNOS : CMM : NOTIF : [CMM_CMIS_MODULE_HOST_LANE_MONITOR_4]: FERC Current
Sample Value Input[High Warning] recovered on Port[1] module. Reading[0.000 1e-6], Threshold
[500000.000 1e-6]. Vendor[CIENA ] Serial[Q00JF7FD ]
```

```
Netconf:-
```

```
=====
```

```
yangcli ocnos@127.1>
```

```
Incoming notification:
```

```
<notification xmlns="urn:ietf:params:xml:ns:netconf:notification:1.0">
```

```
<eventTime>2024-09-01T23:20:37Z</eventTime>
```

```
<netconf-config-change xmlns="urn:ietf:params:xml:ns:yang:ietf-netconf-notifications">
```

```
<changed-by>
```

```
<username>root</username>
```

```
<session-id>0</session-id>
```

```
</changed-by>
```

```
<datastore>running</datastore>
```

```
<edit>
```

```
<target
```

```
xmlns:ipi-interface="http://www.ipinfusion.com/yang/ocnos/ipi-interface"/ipi-
interface:interfaces/ipi-interface:interface[ipi-interface:name='cdl']/ipi-interface:config</target>
```

```
<operation>merge</operation>
```

```

    </edit>
  </netconf-config-change>
</notification>

Incoming notification: Interface went to down state
<notification xmlns="urn:ietf:params:xml:ns:netconf:notification:1.0">
  <eventTime>2024-09-01T23:20:37Z</eventTime>
  <interface-link-state-change-notification xmlns="http://www.ipinfusion.com/yang/ocnos/ipi-
interface">
    <severity>critical</severity>
    <eventClass>state</eventClass>
    <name>cd1</name>
    <oper-status>down</oper-status>
  </interface-link-state-change-notification>
</notification>

```

```

Incoming notification: Here we can see the TX-LOS alarm.
<notification xmlns="urn:ietf:params:xml:ns:netconf:notification:1.0">
  <eventTime>2024-09-01T23:20:43Z</eventTime>
  <cmis-module-host-flag-alarm-notification xmlns="http://www.ipinfusion.com/yang/ocnos/ipi-
platform">
    <severity>critical</severity>
    <eventClass>state</eventClass>
    <number>1</number>
    <name>CMIS-MODULE-1</name>
    <alarm-id>Tx-LOS</alarm-id>
  </cmis-module-host-flag-alarm-notification>
</notification>

```

```

Incoming notification:
<notification xmlns="urn:ietf:params:xml:ns:netconf:notification:1.0">
  <eventTime>2024-09-01T23:20:43Z</eventTime>
  <cmis-module-host-flag-alarm-notification xmlns="http://www.ipinfusion.com/yang/ocnos/ipi-
platform">
    <severity>critical</severity>
    <eventClass>state</eventClass>
    <number>1</number>
    <name>CMIS-MODULE-1</name>
    <alarm-id>FEC-Detected-Degrade</alarm-id>
  </cmis-module-host-flag-alarm-notification>
</notification>

```

```

Incoming notification:
<notification xmlns="urn:ietf:params:xml:ns:netconf:notification:1.0">
  <eventTime>2024-09-01T23:20:43Z</eventTime>
  <cmis-module-host-flag-alarm-notification xmlns="http://www.ipinfusion.com/yang/ocnos/ipi-
platform">
    <severity>critical</severity>
    <eventClass>state</eventClass>
    <number>1</number>
    <name>CMIS-MODULE-1</name>
    <alarm-id>Tx-Loss-of-Alignment</alarm-id>
  </cmis-module-host-flag-alarm-notification>
</notification>

```

```

Incoming notification: Here we can see the Remote Fault alarm.
<notification xmlns="urn:ietf:params:xml:ns:netconf:notification:1.0">
  <eventTime>2024-09-01T23:20:43Z</eventTime>
  <cmis-module-host-flag-alarm-notification xmlns="http://www.ipinfusion.com/yang/ocnos/ipi-
platform">
    <severity>critical</severity>
    <eventClass>state</eventClass>
    <number>1</number>
    <name>CMIS-MODULE-1</name>
    <alarm-id>Rx-Remote-Fault</alarm-id>
  </cmis-module-host-flag-alarm-notification>
</notification>

```

Incoming notification:

```
<notification xmlns="urn:ietf:params:xml:ns:netconf:notification:1.0">
  <eventTime>2024-09-01T23:20:43Z</eventTime>
  <cmis-module-host-monitor-alarm-notification xmlns="http://www.ipinfusion.com/yang/ocnos/ipi-
platform">
    <severity>critical</severity>
    <eventClass>state</eventClass>
    <number>1</number>
    <name>CMIS-MODULE-1</name>
    <alarm-id>Pre-FEC-BER-Current-Sample-Input</alarm-id>
    <alarm-type>High-alarm</alarm-type>
    <current-value>0.0</current-value>
    <threshold-minimum>0.0</threshold-minimum>
    <threshold-maximum>239.00</threshold-maximum>
  </cmis-module-host-monitor-alarm-notification>
</notification>
```

Incoming notification:

```
<notification xmlns="urn:ietf:params:xml:ns:netconf:notification:1.0">
  <eventTime>2024-09-01T23:20:43Z</eventTime>
  <cmis-module-host-monitor-alarm-notification xmlns="http://www.ipinfusion.com/yang/ocnos/ipi-
platform">
    <severity>critical</severity>
    <eventClass>state</eventClass>
    <number>1</number>
    <name>CMIS-MODULE-1</name>
    <alarm-id>Pre-FEC-BER-Current-Sample-Input</alarm-id>
    <alarm-type>High-warning</alarm-type>
    <current-value>0.0</current-value>
    <threshold-minimum>0.0</threshold-minimum>
    <threshold-maximum>43.80</threshold-maximum>
  </cmis-module-host-monitor-alarm-notification>
</notification>
```

Incoming notification:

```
<notification xmlns="urn:ietf:params:xml:ns:netconf:notification:1.0">
  <eventTime>2024-09-01T23:20:43Z</eventTime>
  <cmis-module-host-monitor-alarm-notification xmlns="http://www.ipinfusion.com/yang/ocnos/ipi-
platform">
    <severity>critical</severity>
    <eventClass>state</eventClass>
    <number>1</number>
    <name>CMIS-MODULE-1</name>
    <alarm-id>FERC-Maximum-Sample-Value-Input</alarm-id>
    <alarm-type>High-alarm</alarm-type>
    <current-value>1000000.00</current-value>
    <threshold-minimum>0.0</threshold-minimum>
    <threshold-maximum>500000.00</threshold-maximum>
  </cmis-module-host-monitor-alarm-notification>
</notification>
```

Incoming notification:

```
<notification xmlns="urn:ietf:params:xml:ns:netconf:notification:1.0">
  <eventTime>2024-09-01T23:20:43Z</eventTime>
  <cmis-module-host-monitor-alarm-notification xmlns="http://www.ipinfusion.com/yang/ocnos/ipi-
platform">
    <severity>critical</severity>
    <eventClass>state</eventClass>
    <number>1</number>
    <name>CMIS-MODULE-1</name>
    <alarm-id>FERC-Maximum-Sample-Value-Input</alarm-id>
    <alarm-type>High-warning</alarm-type>
    <current-value>1000000.00</current-value>
    <threshold-minimum>0.0</threshold-minimum>
    <threshold-maximum>500000.00</threshold-maximum>
  </cmis-module-host-monitor-alarm-notification>
</notification>
```

```

Incoming notification:
<notification xmlns="urn:ietf:params:xml:ns:netconf:notification:1.0">
  <eventTime>2024-09-01T23:20:43Z</eventTime>
  <cmis-module-host-monitor-alarm-notification xmlns="http://www.ipinfusion.com/yang/ocnos/ipi-
platform">
    <severity>critical</severity>
    <eventClass>state</eventClass>
    <number>1</number>
    <name>CMIS-MODULE-1</name>
    <alarm-id>FERC-Sample-Average-Value-Input</alarm-id>
    <alarm-type>High-alarm</alarm-type>
    <current-value>1000000.00</current-value>
    <threshold-minimum>0.0</threshold-minimum>
    <threshold-maximum>500000.00</threshold-maximum>
  </cmis-module-host-monitor-alarm-notification>
</notification>

```

```

Incoming notification:
<notification xmlns="urn:ietf:params:xml:ns:netconf:notification:1.0">
  <eventTime>2024-09-01T23:20:43Z</eventTime>
  <cmis-module-host-monitor-alarm-notification xmlns="http://www.ipinfusion.com/yang/ocnos/ipi-
platform">
    <severity>critical</severity>
    <eventClass>state</eventClass>
    <number>1</number>
    <name>CMIS-MODULE-1</name>
    <alarm-id>FERC-Sample-Average-Value-Input</alarm-id>
    <alarm-type>High-warning</alarm-type>
    <current-value>1000000.00</current-value>
    <threshold-minimum>0.0</threshold-minimum>
    <threshold-maximum>500000.00</threshold-maximum>
  </cmis-module-host-monitor-alarm-notification>
</notification>

```

```
yangcli ocnos@127.1>
```

```

Incoming notification:
<notification xmlns="urn:ietf:params:xml:ns:netconf:notification:1.0">
  <eventTime>2024-09-01T23:20:43Z</eventTime>
  <cmis-module-host-monitor-alarm-notification xmlns="http://www.ipinfusion.com/yang/ocnos/ipi-
platform">
    <severity>critical</severity>
    <eventClass>state</eventClass>
    <number>1</number>
    <name>CMIS-MODULE-1</name>
    <alarm-id>FERC-Current-Sample-Value-Input</alarm-id>
    <alarm-type>High-alarm</alarm-type>
    <current-value>0.0</current-value>
    <threshold-minimum>0.0</threshold-minimum>
    <threshold-maximum>500000.00</threshold-maximum>
  </cmis-module-host-monitor-alarm-notification>
</notification>

```

```

Incoming notification:
<notification xmlns="urn:ietf:params:xml:ns:netconf:notification:1.0">
  <eventTime>2024-09-01T23:20:43Z</eventTime>
  <cmis-module-host-monitor-alarm-notification xmlns="http://www.ipinfusion.com/yang/ocnos/ipi-
platform">
    <severity>critical</severity>
    <eventClass>state</eventClass>
    <number>1</number>
    <name>CMIS-MODULE-1</name>
    <alarm-id>FERC-Current-Sample-Value-Input</alarm-id>
    <alarm-type>High-warning</alarm-type>
    <current-value>0.0</current-value>
    <threshold-minimum>0.0</threshold-minimum>
    <threshold-maximum>500000.00</threshold-maximum>
  </cmis-module-host-monitor-alarm-notification>

```



```
</notification>
```

Incoming notification:

```
<notification xmlns="urn:ietf:params:xml:ns:netconf:notification:1.0">
  <eventTime>2024-09-01T23:20:44Z</eventTime>
  <cmis-module-host-flag-alarm-notification xmlns="http://www.ipinfusion.com/yang/ocnos/ipi-
platform">
    <severity>critical</severity>
    <eventClass>state</eventClass>
    <number>2</number>
    <name>CMIS-MODULE-1</name>
    <alarm-id>Tx-LOS</alarm-id>
  </cmis-module-host-flag-alarm-notification>
</notification>
```

Incoming notification:

```
<notification xmlns="urn:ietf:params:xml:ns:netconf:notification:1.0">
  <eventTime>2024-09-01T23:20:44Z</eventTime>
  <cmis-module-host-flag-alarm-notification xmlns="http://www.ipinfusion.com/yang/ocnos/ipi-
platform">
    <severity>critical</severity>
    <eventClass>state</eventClass>
    <number>4</number>
    <name>CMIS-MODULE-1</name>
    <alarm-id>Tx-LOS</alarm-id>
  </cmis-module-host-flag-alarm-notification>
</notification>
```

Incoming notification:

```
<notification xmlns="urn:ietf:params:xml:ns:netconf:notification:1.0">
  <eventTime>2024-09-01T23:20:44Z</eventTime>
  <cmis-module-host-flag-alarm-notification xmlns="http://www.ipinfusion.com/yang/ocnos/ipi-
platform">
    <severity>critical</severity>
    <eventClass>state</eventClass>
    <number>6</number>
    <name>CMIS-MODULE-1</name>
    <alarm-id>Tx-LOS</alarm-id>
  </cmis-module-host-flag-alarm-notification>
</notification>
```

Incoming notification:

```
<notification xmlns="urn:ietf:params:xml:ns:netconf:notification:1.0">
  <eventTime>2024-09-01T23:20:53Z</eventTime>
  <cmis-module-host-flag-recovery-notification xmlns="http://www.ipinfusion.com/yang/ocnos/ipi-
platform">
    <severity>info</severity>
    <eventClass>state</eventClass>
    <number>2</number>
    <name>CMIS-MODULE-1</name>
    <alarm-id>Tx-LOS</alarm-id>
  </cmis-module-host-flag-recovery-notification>
</notification>
```

Incoming notification:

```
<notification xmlns="urn:ietf:params:xml:ns:netconf:notification:1.0">
  <eventTime>2024-09-01T23:20:53Z</eventTime>
  <cmis-module-host-flag-recovery-notification xmlns="http://www.ipinfusion.com/yang/ocnos/ipi-
platform">
    <severity>info</severity>
    <eventClass>state</eventClass>
    <number>6</number>
    <name>CMIS-MODULE-1</name>
    <alarm-id>Tx-LOS</alarm-id>
  </cmis-module-host-flag-recovery-notification>
</notification>
```

Incoming notification:

```
<notification xmlns="urn:ietf:params:xml:ns:netconf:notification:1.0">
  <eventTime>2024-09-01T23:20:53Z</eventTime>
  <cmis-module-host-flag-alarm-notification xmlns="http://www.ipinfusion.com/yang/ocnos/ipi-
platform">
    <severity>critical</severity>
    <eventClass>state</eventClass>
    <number>7</number>
    <name>CMIS-MODULE-1</name>
    <alarm-id>Tx-LOS</alarm-id>
  </cmis-module-host-flag-alarm-notification>
</notification>
```

Incoming notification:

```
<notification xmlns="urn:ietf:params:xml:ns:netconf:notification:1.0">
  <eventTime>2024-09-01T23:21:03Z</eventTime>
  <cmis-module-host-monitor-recovery-notification xmlns="http://www.ipinfusion.com/yang/ocnos/ipi-
platform">
    <severity>info</severity>
    <eventClass>state</eventClass>
    <number>1</number>
    <name>CMIS-MODULE-1</name>
    <alarm-id>FERC-Maximum-Sample-Value-Input</alarm-id>
    <current-value>0.0</current-value>
    <threshold-minimum>0.0</threshold-minimum>
    <threshold-maximum>500000.00</threshold-maximum>
  </cmis-module-host-monitor-recovery-notification>
</notification>
```

Incoming notification:

```
<notification xmlns="urn:ietf:params:xml:ns:netconf:notification:1.0">
  <eventTime>2024-09-01T23:21:03Z</eventTime>
  <cmis-module-host-monitor-recovery-notification xmlns="http://www.ipinfusion.com/yang/ocnos/ipi-
platform">
    <severity>info</severity>
    <eventClass>state</eventClass>
    <number>1</number>
    <name>CMIS-MODULE-1</name>
    <alarm-id>FERC-Maximum-Sample-Value-Input</alarm-id>
    <current-value>0.0</current-value>
    <threshold-minimum>0.0</threshold-minimum>
    <threshold-maximum>500000.00</threshold-maximum>
  </cmis-module-host-monitor-recovery-notification>
</notification>
```

Incoming notification:

```
<notification xmlns="urn:ietf:params:xml:ns:netconf:notification:1.0">
  <eventTime>2024-09-01T23:21:03Z</eventTime>
  <cmis-module-host-monitor-recovery-notification xmlns="http://www.ipinfusion.com/yang/ocnos/ipi-
platform">
    <severity>info</severity>
    <eventClass>state</eventClass>
    <number>1</number>
    <name>CMIS-MODULE-1</name>
    <alarm-id>FERC-Sample-Average-Value-Input</alarm-id>
    <current-value>0.0</current-value>
    <threshold-minimum>0.0</threshold-minimum>
    <threshold-maximum>500000.00</threshold-maximum>
  </cmis-module-host-monitor-recovery-notification>
</notification>
```

Incoming notification:

```
<notification xmlns="urn:ietf:params:xml:ns:netconf:notification:1.0">
  <eventTime>2024-09-01T23:21:03Z</eventTime>
  <cmis-module-host-monitor-recovery-notification xmlns="http://www.ipinfusion.com/yang/ocnos/ipi-
platform">
    <severity>info</severity>
    <eventClass>state</eventClass>
    <number>1</number>
```

```

    <name>CMIS-MODULE-1</name>
    <alarm-id>FERC-Sample-Average-Value-Input</alarm-id>
    <current-value>0.0</current-value>
    <threshold-minimum>0.0</threshold-minimum>
    <threshold-maximum>500000.00</threshold-maximum>
  </cmis-module-host-monitor-recovery-notification>
</notification>

```

Incoming notification:

```

<notification xmlns="urn:ietf:params:xml:ns:netconf:notification:1.0">
  <eventTime>2024-09-01T23:21:03Z</eventTime>
  <cmis-module-host-flag-alarm-notification xmlns="http://www.ipinfusion.com/yang/ocnos/ipi-
platform">
    <severity>critical</severity>
    <eventClass>state</eventClass>
    <number>2</number>
    <name>CMIS-MODULE-1</name>
    <alarm-id>Tx-LOS</alarm-id>
  </cmis-module-host-flag-alarm-notification>
</notification>

```

Incoming notification:

```

<notification xmlns="urn:ietf:params:xml:ns:netconf:notification:1.0">
  <eventTime>2024-09-01T23:21:04Z</eventTime>
  <cmis-module-host-flag-alarm-notification xmlns="http://www.ipinfusion.com/yang/ocnos/ipi-
platform">
    <severity>critical</severity>
    <eventClass>state</eventClass>
    <number>3</number>
    <name>CMIS-MODULE-1</name>
    <alarm-id>Tx-LOS</alarm-id>
  </cmis-module-host-flag-alarm-notification>
</notification>

```

Incoming notification:

```

<notification xmlns="urn:ietf:params:xml:ns:netconf:notification:1.0">
  <eventTime>2024-09-01T23:21:04Z</eventTime>
  <cmis-module-host-flag-recovery-notification xmlns="http://www.ipinfusion.com/yang/ocnos/ipi-
platform">
    <severity>info</severity>
    <eventClass>state</eventClass>
    <number>7</number>
    <name>CMIS-MODULE-1</name>
    <alarm-id>Tx-LOS</alarm-id>
  </cmis-module-host-flag-recovery-notification>
</notification>

```

Incoming notification:

```

<notification xmlns="urn:ietf:params:xml:ns:netconf:notification:1.0">
  <eventTime>2024-09-01T23:21:04Z</eventTime>
  <cmis-module-host-flag-alarm-notification xmlns="http://www.ipinfusion.com/yang/ocnos/ipi-
platform">
    <severity>critical</severity>
    <eventClass>state</eventClass>
    <number>8</number>
    <name>CMIS-MODULE-1</name>
    <alarm-id>Tx-LOS</alarm-id>
  </cmis-module-host-flag-alarm-notification>
</notification>

```

yangcli ocnos@127.1>

Incoming notification:

```

<notification xmlns="urn:ietf:params:xml:ns:netconf:notification:1.0">
  <eventTime>2024-09-01T23:21:13Z</eventTime>
  <cmis-module-host-flag-recovery-notification xmlns="http://www.ipinfusion.com/yang/ocnos/ipi-
platform">
    <severity>info</severity>

```

```

    <eventClass>state</eventClass>
    <number>2</number>
    <name>CMIS-MODULE-1</name>
    <alarm-id>Tx-LOS</alarm-id>
  </cmis-module-host-flag-recovery-notification>
</notification>

```

Incoming notification:

```

<notification xmlns="urn:ietf:params:xml:ns:netconf:notification:1.0">
  <eventTime>2024-09-01T23:21:14Z</eventTime>
  <cmis-module-host-flag-recovery-notification xmlns="http://www.ipinfusion.com/yang/ocnos/ipi-
platform">
    <severity>info</severity>
    <eventClass>state</eventClass>
    <number>4</number>
    <name>CMIS-MODULE-1</name>
    <alarm-id>Tx-LOS</alarm-id>
  </cmis-module-host-flag-recovery-notification>
</notification>

```

Incoming notification:

```

<notification xmlns="urn:ietf:params:xml:ns:netconf:notification:1.0">
  <eventTime>2024-09-01T23:21:14Z</eventTime>
  <cmis-module-host-flag-alarm-notification xmlns="http://www.ipinfusion.com/yang/ocnos/ipi-
platform">
    <severity>critical</severity>
    <eventClass>state</eventClass>
    <number>5</number>
    <name>CMIS-MODULE-1</name>
    <alarm-id>Tx-LOS</alarm-id>
  </cmis-module-host-flag-alarm-notification>
</notification>

```

Incoming notification:

```

<notification xmlns="urn:ietf:params:xml:ns:netconf:notification:1.0">
  <eventTime>2024-09-01T23:21:14Z</eventTime>
  <cmis-module-host-flag-alarm-notification xmlns="http://www.ipinfusion.com/yang/ocnos/ipi-
platform">
    <severity>critical</severity>
    <eventClass>state</eventClass>
    <number>6</number>
    <name>CMIS-MODULE-1</name>
    <alarm-id>Tx-LOS</alarm-id>
  </cmis-module-host-flag-alarm-notification>
</notification>

```

Incoming notification:

```

<notification xmlns="urn:ietf:params:xml:ns:netconf:notification:1.0">
  <eventTime>2024-09-01T23:21:14Z</eventTime>
  <cmis-module-host-flag-recovery-notification xmlns="http://www.ipinfusion.com/yang/ocnos/ipi-
platform">
    <severity>info</severity>
    <eventClass>state</eventClass>
    <number>8</number>
    <name>CMIS-MODULE-1</name>
    <alarm-id>Tx-LOS</alarm-id>
  </cmis-module-host-flag-recovery-notification>
</notification>

```

Incoming notification:

```

<notification xmlns="urn:ietf:params:xml:ns:netconf:notification:1.0">
  <eventTime>2024-09-01T23:21:24Z</eventTime>
  <cmis-module-host-flag-alarm-notification xmlns="http://www.ipinfusion.com/yang/ocnos/ipi-
platform">
    <severity>critical</severity>
    <eventClass>state</eventClass>
    <number>2</number>
    <name>CMIS-MODULE-1</name>

```

```

    <alarm-id>Tx-LOS</alarm-id>
  </cmis-module-host-flag-alarm-notification>
</notification>

Incoming notification:
<notification xmlns="urn:ietf:params:xml:ns:netconf:notification:1.0">
  <eventTime>2024-09-01T23:21:24Z</eventTime>
  <cmis-module-host-flag-recovery-notification xmlns="http://www.ipinfusion.com/yang/ocnos/ipi-
platform">
    <severity>info</severity>
    <eventClass>state</eventClass>
    <number>3</number>
    <name>CMIS-MODULE-1</name>
    <alarm-id>Tx-LOS</alarm-id>
  </cmis-module-host-flag-recovery-notification>
</notification>

Incoming notification:
<notification xmlns="urn:ietf:params:xml:ns:netconf:notification:1.0">
  <eventTime>2024-09-01T23:21:24Z</eventTime>
  <cmis-module-host-flag-alarm-notification xmlns="http://www.ipinfusion.com/yang/ocnos/ipi-
platform">
    <severity>critical</severity>
    <eventClass>state</eventClass>
    <number>4</number>
    <name>CMIS-MODULE-1</name>
    <alarm-id>Tx-LOS</alarm-id>
  </cmis-module-host-flag-alarm-notification>
</notification>

Incoming notification:
<notification xmlns="urn:ietf:params:xml:ns:netconf:notification:1.0">
  <eventTime>2024-09-01T23:21:24Z</eventTime>
  <cmis-module-host-flag-recovery-notification xmlns="http://www.ipinfusion.com/yang/ocnos/ipi-
platform">
    <severity>info</severity>
    <eventClass>state</eventClass>
    <number>5</number>
    <name>CMIS-MODULE-1</name>
    <alarm-id>Tx-LOS</alarm-id>
  </cmis-module-host-flag-recovery-notification>
</notification>

Incoming notification:
<notification xmlns="urn:ietf:params:xml:ns:netconf:notification:1.0">
  <eventTime>2024-09-01T23:21:34Z</eventTime>
  <cmis-module-host-flag-recovery-notification xmlns="http://www.ipinfusion.com/yang/ocnos/ipi-
platform">
    <severity>info</severity>
    <eventClass>state</eventClass>
    <number>4</number>
    <name>CMIS-MODULE-1</name>
    <alarm-id>Tx-LOS</alarm-id>
  </cmis-module-host-flag-recovery-notification>
</notification>

Incoming notification:
<notification xmlns="urn:ietf:params:xml:ns:netconf:notification:1.0">
  <eventTime>2024-09-01T23:21:34Z</eventTime>
  <cmis-module-host-flag-alarm-notification xmlns="http://www.ipinfusion.com/yang/ocnos/ipi-
platform">
    <severity>critical</severity>
    <eventClass>state</eventClass>
    <number>5</number>
    <name>CMIS-MODULE-1</name>
    <alarm-id>Tx-LOS</alarm-id>
  </cmis-module-host-flag-alarm-notification>
</notification>

```

Incoming notification:

```
<notification xmlns="urn:ietf:params:xml:ns:netconf:notification:1.0">
  <eventTime>2024-09-01T23:21:34Z</eventTime>
  <cmis-module-host-flag-alarm-notification xmlns="http://www.ipinfusion.com/yang/ocnos/ipi-
platform">
    <severity>critical</severity>
    <eventClass>state</eventClass>
    <number>7</number>
    <name>CMIS-MODULE-1</name>
    <alarm-id>Tx-LOS</alarm-id>
  </cmis-module-host-flag-alarm-notification>
</notification>
```

Incoming notification:

```
<notification xmlns="urn:ietf:params:xml:ns:netconf:notification:1.0">
  <eventTime>2024-09-01T23:21:43Z</eventTime>
  <cmis-module-host-flag-recovery-notification xmlns="http://www.ipinfusion.com/yang/ocnos/ipi-
platform">
    <severity>info</severity>
    <eventClass>state</eventClass>
    <number>6</number>
    <name>CMIS-MODULE-1</name>
    <alarm-id>Tx-LOS</alarm-id>
  </cmis-module-host-flag-recovery-notification>
</notification>
```

Incoming notification:

```
<notification xmlns="urn:ietf:params:xml:ns:netconf:notification:1.0">
  <eventTime>2024-09-01T23:21:43Z</eventTime>
  <cmis-module-host-flag-recovery-notification xmlns="http://www.ipinfusion.com/yang/ocnos/ipi-
platform">
    <severity>info</severity>
    <eventClass>state</eventClass>
    <number>7</number>
    <name>CMIS-MODULE-1</name>
    <alarm-id>Tx-LOS</alarm-id>
  </cmis-module-host-flag-recovery-notification>
</notification>
```

Incoming notification:

```
<notification xmlns="urn:ietf:params:xml:ns:netconf:notification:1.0">
  <eventTime>2024-09-01T23:21:43Z</eventTime>
  <cmis-module-host-flag-alarm-notification xmlns="http://www.ipinfusion.com/yang/ocnos/ipi-
platform">
    <severity>critical</severity>
    <eventClass>state</eventClass>
    <number>8</number>
    <name>CMIS-MODULE-1</name>
    <alarm-id>Tx-LOS</alarm-id>
  </cmis-module-host-flag-alarm-notification>
</notification>
```

yangcli ocnos@127.1>

Incoming notification:

```
<notification xmlns="urn:ietf:params:xml:ns:netconf:notification:1.0">
  <eventTime>2024-09-01T23:21:50Z</eventTime>
  <netconf-config-change xmlns="urn:ietf:params:xml:ns:yang:ietf-netconf-notifications">
    <changed-by>
      <username>root</username>
      <session-id>0</session-id>
    </changed-by>
    <datastore>running</datastore>
    <edit>
      <target
        xmlns:ipi-interface="http://www.ipinfusion.com/yang/ocnos/ipi-interface">/ipi-
interface:interfaces/ipi-interface:interface[ipi-interface:name='cdl']/ipi-interface:config</target>
```

```

    <operation>merge</operation>
  </edit>
</netconf-config-change>
</notification>

```

Incoming notification: Here we can see the Local Fault alarm.

```

<notification xmlns="urn:ietf:params:xml:ns:netconf:notification:1.0">
  <eventTime>2024-09-01T23:21:54Z</eventTime>
  <cmis-module-host-flag-alarm-notification xmlns="http://www.ipinfusion.com/yang/ocnos/ipi-
platform">
    <severity>critical</severity>
    <eventClass>state</eventClass>
    <number>1</number>
    <name>CMIS-MODULE-1</name>
    <alarm-id>Tx-Local-Fault</alarm-id>
  </cmis-module-host-flag-alarm-notification>
</notification>

```

Incoming notification:

```

<notification xmlns="urn:ietf:params:xml:ns:netconf:notification:1.0">
  <eventTime>2024-09-01T23:21:54Z</eventTime>
  <cmis-module-host-flag-alarm-notification xmlns="http://www.ipinfusion.com/yang/ocnos/ipi-
platform">
    <severity>critical</severity>
    <eventClass>state</eventClass>
    <number>1</number>
    <name>CMIS-MODULE-1</name>
    <alarm-id>Tx-Remote-Fault</alarm-id>
  </cmis-module-host-flag-alarm-notification>
</notification>

```

Incoming notification:

```

<notification xmlns="urn:ietf:params:xml:ns:netconf:notification:1.0">
  <eventTime>2024-09-01T23:21:54Z</eventTime>
  <cmis-module-host-monitor-alarm-notification xmlns="http://www.ipinfusion.com/yang/ocnos/ipi-
platform">
    <severity>critical</severity>
    <eventClass>state</eventClass>
    <number>1</number>
    <name>CMIS-MODULE-1</name>
    <alarm-id>FERC-Maximum-Sample-Value-Input</alarm-id>
    <alarm-type>High-alarm</alarm-type>
    <current-value>0.0</current-value>
    <threshold-minimum>0.0</threshold-minimum>
    <threshold-maximum>500000.00</threshold-maximum>
  </cmis-module-host-monitor-alarm-notification>
</notification>

```

Incoming notification:

```

<notification xmlns="urn:ietf:params:xml:ns:netconf:notification:1.0">
  <eventTime>2024-09-01T23:21:54Z</eventTime>
  <cmis-module-host-monitor-alarm-notification xmlns="http://www.ipinfusion.com/yang/ocnos/ipi-
platform">
    <severity>critical</severity>
    <eventClass>state</eventClass>
    <number>1</number>
    <name>CMIS-MODULE-1</name>
    <alarm-id>FERC-Maximum-Sample-Value-Input</alarm-id>
    <alarm-type>High-warning</alarm-type>
    <current-value>0.0</current-value>
    <threshold-minimum>0.0</threshold-minimum>
    <threshold-maximum>500000.00</threshold-maximum>
  </cmis-module-host-monitor-alarm-notification>
</notification>

```

Incoming notification:

```

<notification xmlns="urn:ietf:params:xml:ns:netconf:notification:1.0">
  <eventTime>2024-09-01T23:21:54Z</eventTime>
  <cmis-module-host-monitor-alarm-notification xmlns="http://www.ipinfusion.com/yang/ocnos/ipi-

```

```

platform">
  <severity>critical</severity>
  <eventClass>state</eventClass>
  <number>1</number>
  <name>CMIS-MODULE-1</name>
  <alarm-id>FERC-Sample-Average-Value-Input</alarm-id>
  <alarm-type>High-alarm</alarm-type>
  <current-value>0.0</current-value>
  <threshold-minimum>0.0</threshold-minimum>
  <threshold-maximum>500000.00</threshold-maximum>
</cmis-module-host-monitor-alarm-notification>
</notification>

Incoming notification:
<notification xmlns="urn:ietf:params:xml:ns:netconf:notification:1.0">
  <eventTime>2024-09-01T23:21:54Z</eventTime>
  <cmis-module-host-monitor-alarm-notification xmlns="http://www.ipinfusion.com/yang/ocnos/ipi-
platform">
    <severity>critical</severity>
    <eventClass>state</eventClass>
    <number>1</number>
    <name>CMIS-MODULE-1</name>
    <alarm-id>FERC-Sample-Average-Value-Input</alarm-id>
    <alarm-type>High-warning</alarm-type>
    <current-value>0.0</current-value>
    <threshold-minimum>0.0</threshold-minimum>
    <threshold-maximum>500000.00</threshold-maximum>
  </cmis-module-host-monitor-alarm-notification>
</notification>

Incoming notification:
<notification xmlns="urn:ietf:params:xml:ns:netconf:notification:1.0">
  <eventTime>2024-09-01T23:21:54Z</eventTime>
  <cmis-module-host-flag-recovery-notification xmlns="http://www.ipinfusion.com/yang/ocnos/ipi-
platform">
    <severity>info</severity>
    <eventClass>state</eventClass>
    <number>2</number>
    <name>CMIS-MODULE-1</name>
    <alarm-id>Tx-LOS</alarm-id>
  </cmis-module-host-flag-recovery-notification>
</notification>

Incoming notification:
<notification xmlns="urn:ietf:params:xml:ns:netconf:notification:1.0">
  <eventTime>2024-09-01T23:21:54Z</eventTime>
  <cmis-module-host-flag-recovery-notification xmlns="http://www.ipinfusion.com/yang/ocnos/ipi-
platform">
    <severity>info</severity>
    <eventClass>state</eventClass>
    <number>5</number>
    <name>CMIS-MODULE-1</name>
    <alarm-id>Tx-LOS</alarm-id>
  </cmis-module-host-flag-recovery-notification>
</notification>

Incoming notification:
<notification xmlns="urn:ietf:params:xml:ns:netconf:notification:1.0">
  <eventTime>2024-09-01T23:21:55Z</eventTime>
  <cmis-module-host-flag-recovery-notification xmlns="http://www.ipinfusion.com/yang/ocnos/ipi-
platform">
    <severity>info</severity>
    <eventClass>state</eventClass>
    <number>8</number>
    <name>CMIS-MODULE-1</name>
    <alarm-id>Tx-LOS</alarm-id>
  </cmis-module-host-flag-recovery-notification>
</notification>

```

Incoming notification: Here we can see the recovery of TX-LOS alarm.

```
<notification xmlns="urn:ietf:params:xml:ns:netconf:notification:1.0">
  <eventTime>2024-09-01T23:22:03Z</eventTime>
  <cmis-module-host-flag-recovery-notification xmlns="http://www.ipinfusion.com/yang/ocnos/ipi-
platform">
    <severity>info</severity>
    <eventClass>state</eventClass>
    <number>1</number>
    <name>CMIS-MODULE-1</name>
    <alarm-id>Tx-LOS</alarm-id>
  </cmis-module-host-flag-recovery-notification>
</notification>
```

Incoming notification: Here we can see the recovery of Local fault alarm.

```
<notification xmlns="urn:ietf:params:xml:ns:netconf:notification:1.0">
  <eventTime>2024-09-01T23:22:03Z</eventTime>
  <cmis-module-host-flag-recovery-notification xmlns="http://www.ipinfusion.com/yang/ocnos/ipi-
platform">
    <severity>info</severity>
    <eventClass>state</eventClass>
    <number>1</number>
    <name>CMIS-MODULE-1</name>
    <alarm-id>Tx-Local-Fault</alarm-id>
  </cmis-module-host-flag-recovery-notification>
</notification>
```

Incoming notification: Here we can see the recovery of Remote fault alarm.

```
<notification xmlns="urn:ietf:params:xml:ns:netconf:notification:1.0">
  <eventTime>2024-09-01T23:22:03Z</eventTime>
  <cmis-module-host-flag-recovery-notification xmlns="http://www.ipinfusion.com/yang/ocnos/ipi-
platform">
    <severity>info</severity>
    <eventClass>state</eventClass>
    <number>1</number>
    <name>CMIS-MODULE-1</name>
    <alarm-id>Tx-Remote-Fault</alarm-id>
  </cmis-module-host-flag-recovery-notification>
</notification>
```

Incoming notification:

```
<notification xmlns="urn:ietf:params:xml:ns:netconf:notification:1.0">
  <eventTime>2024-09-01T23:22:03Z</eventTime>
  <cmis-module-host-monitor-recovery-notification xmlns="http://www.ipinfusion.com/yang/ocnos/ipi-
platform">
    <severity>info</severity>
    <eventClass>state</eventClass>
    <number>1</number>
    <name>CMIS-MODULE-1</name>
    <alarm-id>FERC-Maximum-Sample-Value-Input</alarm-id>
    <current-value>0.0</current-value>
    <threshold-minimum>0.0</threshold-minimum>
    <threshold-maximum>500000.00</threshold-maximum>
  </cmis-module-host-monitor-recovery-notification>
</notification>
```

Incoming notification:

```
<notification xmlns="urn:ietf:params:xml:ns:netconf:notification:1.0">
  <eventTime>2024-09-01T23:22:03Z</eventTime>
  <cmis-module-host-monitor-recovery-notification xmlns="http://www.ipinfusion.com/yang/ocnos/ipi-
platform">
    <severity>info</severity>
    <eventClass>state</eventClass>
    <number>1</number>
    <name>CMIS-MODULE-1</name>
    <alarm-id>FERC-Maximum-Sample-Value-Input</alarm-id>
    <current-value>0.0</current-value>
    <threshold-minimum>0.0</threshold-minimum>
```

```

    <threshold-maximum>500000.00</threshold-maximum>
  </cmis-module-host-monitor-recovery-notification>
</notification>

```

Incoming notification:

```

<notification xmlns="urn:ietf:params:xml:ns:netconf:notification:1.0">
  <eventTime>2024-09-01T23:22:03Z</eventTime>
  <cmis-module-host-monitor-recovery-notification xmlns="http://www.ipinfusion.com/yang/ocnos/ipi-
platform">
    <severity>info</severity>
    <eventClass>state</eventClass>
    <number>1</number>
    <name>CMIS-MODULE-1</name>
    <alarm-id>FERC-Sample-Average-Value-Input</alarm-id>
    <current-value>0.0</current-value>
    <threshold-minimum>0.0</threshold-minimum>
    <threshold-maximum>500000.00</threshold-maximum>
  </cmis-module-host-monitor-recovery-notification>
</notification>

```

Incoming notification:

```

<notification xmlns="urn:ietf:params:xml:ns:netconf:notification:1.0">
  <eventTime>2024-09-01T23:22:03Z</eventTime>
  <cmis-module-host-monitor-recovery-notification xmlns="http://www.ipinfusion.com/yang/ocnos/ipi-
platform">
    <severity>info</severity>
    <eventClass>state</eventClass>
    <number>1</number>
    <name>CMIS-MODULE-1</name>
    <alarm-id>FERC-Sample-Average-Value-Input</alarm-id>
    <current-value>0.0</current-value>
    <threshold-minimum>0.0</threshold-minimum>
    <threshold-maximum>500000.00</threshold-maximum>
  </cmis-module-host-monitor-recovery-notification>
</notification>

```

Incoming notification: Here we can see that interface came UP.

```

<notification xmlns="urn:ietf:params:xml:ns:netconf:notification:1.0">
  <eventTime>2024-09-01T23:22:03Z </eventTime>
  <interface-link-state-change-notification xmlns="http://www.ipinfusion.com/yang/ocnos/ipi-
interface">
    <severity> minor </severity>
    <eventClass>state</eventClass>
    <name>cd1</name>
    <oper-status>up</oper-status>
  </interface-link-state-change-notification>
</notification>

```

```
yangcli ocnos@127.1>
```

```
SNMP:-
```

```
1.3.6.1.2.1.1.3.0
```

```
SNMP TRAP FOR LINK DOWN:-
```

```
Source: 10.12.95.32 Timestamp: 98 hours 9 minutes 26 seconds SNMP Version: 2
```

```
Trap OID: .1.3.6.1.6.3.1.1.5.3 Community: test
```

```
Variable Bindings:
```

```

-----
Name: .1.3.6.1.2.1.1.3.0
Value: [TimeTicks] 98 hours 9 minutes 26 seconds

```

```

-----
Name: ifIndex
Value: [Integer] 10002

```

```

-----
Name: ifAdminStatus
Value: [Integer] down(2)

```

```

-----
Name: ifOperStatus
Value: [Integer] down(2)

```

```

-----
Name: .1.3.6.1.2.1.1.5.0

```

Value: [OctetString] OCNOS

Description:

SNMP TRAP FOR LINK UP:-

SNMP TRAP FOR Local fault alarm:-

Source: 10.12.95.32 Timestamp: 100 hours 39 minutes 3 seconds SNMP Version: 2

Trap OID: cmmCmisModuleHostFlagsNotifyAlarm Community: test

Variable Bindings:

Name: .1.3.6.1.2.1.1.3.0

Value: [TimeTicks] 100 hours 39 minutes 3 seconds (36234300)

Name: snmpTrapOID

Value: [OID] cmmCmisModuleHostFlagsNotifyAlarm

Name: cmmStackUnitIndex

Value: [Integer] 1

Name: cmmCmisModuleType

Value: [Integer] qsfp-dd (1)

Name: cmmCmisModulePortNumber

Value: [Integer] 3

Name: cmmCmisModuleLaneNumber

Value: [Integer] 1

Name: cmmCmisModuleDescreteAlarmType

Value: [Integer] true (1)

Name: cmmCmisModuleHostLaneAttrFlagType

Value: [Integer] rxlocalfault (19)

Name: .1.3.6.1.2.1.1.5.0

Value: [OctetString] OCNOS

Description: When cmis module host lane descrete attributes flags are set

SNMP TRAP FOR Remote fault Alarm:-

Source: 10.12.95.32 Timestamp: 100 hours 16 minutes 14 seconds SNMP Version: 2

Trap OID: cmmCmisModuleHostFlagsNotifyAlarm Community: test

Variable Bindings:

Name: .1.3.6.1.2.1.1.3.0

Value: [TimeTicks] 100 hours 16 minutes 14 seconds (36097400)

Name: snmpTrapOID

Value: [OID] cmmCmisModuleHostFlagsNotifyAlarm

Name: cmmStackUnitIndex

Value: [Integer] 1

Name: cmmCmisModuleType

Value: [Integer] qsfp-dd (1)

Name: cmmCmisModulePortNumber

Value: [Integer] 1

Name: cmmCmisModuleLaneNumber

Value: [Integer] 1

Name: cmmCmisModuleDescreteAlarmType

Value: [Integer] true (1)

Name: cmmCmisModuleHostLaneAttrFlagType

Value: [Integer] rxremotefault (20)

Name: .1.3.6.1.2.1.1.5.0

Value: [OctetString] OCNOS

```

Description:    When cmmis module host lane discrete attributes flags are set
SNMP TRAP FOR Local fault Recovery:-
Source:        10.12.95.32    Timestamp:    100 hours 27 minutes 34 seconds    SNMP Version:    2
Trap OID:      cmmCmisModuleHostFlagsNotifyAlarmRecovery    Community:    test
Variable Bindings:

```

```

Name:          .1.3.6.1.2.1.1.3.0
Value:        [TimeTicks] 100 hours 27 minutes 34 seconds (36165400)

```

```

Name:          snmpTrapOID
Value:        [OID] cmmCmisModuleHostFlagsNotifyAlarmRecovery

```

```

Name:          cmmStackUnitIndex
Value:        [Integer] 1

```

```

Name:          cmmCmisModuleType
Value:        [Integer] qsfp-dd (1)

```

```

Name:          cmmCmisModulePortNumber
Value:        [Integer] 1

```

```

Name:          cmmCmisModuleLaneNumber
Value:        [Integer] 1

```

```

Name:          cmmCmisModuleDiscreteAlarmType
Value:        [Integer] 0

```

```

Name:          cmmCmisModuleHostLaneAttrFlagType
Value:        [Integer] txlocalfault (16)

```

```

Name:          .1.3.6.1.2.1.1.5.0
Value:        [OctetString] OCNOS

```

```

Description:    When cmmis module host lane discrete attributes flags are recovered
SNMP TRAP FOR TX Remote fault Recovery:-
Source:        10.12.95.32    Timestamp:    100 hours 27 minutes 34 seconds    SNMP Version:    2
Trap OID:      cmmCmisModuleHostFlagsNotifyAlarmRecovery    Community:    test
Variable Bindings:

```

```

Name:          .1.3.6.1.2.1.1.3.0
Value:        [TimeTicks] 100 hours 27 minutes 34 seconds (36165400)

```

```

Name:          snmpTrapOID
Value:        [OID] cmmCmisModuleHostFlagsNotifyAlarmRecovery

```

```

Name:          cmmStackUnitIndex
Value:        [Integer] 1

```

```

Name:          cmmCmisModuleType
Value:        [Integer] qsfp-dd (1)

```

```

Name:          cmmCmisModulePortNumber
Value:        [Integer] 1

```

```

Name:          cmmCmisModuleLaneNumber
Value:        [Integer] 1

```

```

Name:          cmmCmisModuleDiscreteAlarmType
Value:        [Integer] 0

```

```

Name:          cmmCmisModuleHostLaneAttrFlagType
Value:        [Integer] txremotefault (17)

```

```

Name:          .1.3.6.1.2.1.1.5.0
SNMP TRAP FOR Loss RX of alignment:-
Source:        10.12.95.32    Timestamp:    100 hours 16 minutes 14 seconds    SNMP Version:    2
Trap OID:      cmmCmisModuleHostFlagsNotifyAlarm    Community:    test

```

Variable Bindings:

```
Name:      .1.3.6.1.2.1.1.3.0
Value:     [TimeTicks] 100 hours 16 minutes 14 seconds (36097400)

Name:      snmpTrapOID
Value:     [OID] cmmCmisModuleHostFlagsNotifyAlarm

Name:      cmmStackUnitIndex
Value:     [Integer] 1

Name:      cmmCmisModuleType
Value:     [Integer] qsfp-dd (1)

Name:      cmmCmisModulePortNumber
Value:     [Integer] 1

Name:      cmmCmisModuleLaneNumber
Value:     [Integer] 1

Name:      cmmCmisModuleDescreteAlarmType
Value:     [Integer] true (1)

Name:      cmmCmisModuleHostLaneAttrFlagType
Value:     [Integer] rxlossofalignment (18)

Name:      .1.3.6.1.2.1.1.5.0
Value:     [OctetString] OCNOS

Description:  When cmis module host lane descrete attributes flags are set
```

Signal Integrity in QSFP-DD

Overview

The Signal integrity in the context of Quad Small Form Factor Pluggable Double Density (**QSFP-DD**¹) refers to the maintenance of the quality of electrical signals transmitted and received by the QSFP-DD module. QSFP-DD is a high-speed, high-density interface used primarily in data center applications to interconnect switches, servers, and other networking equipment.

Maintaining signal integrity is crucial in high-speed data transmission because any degradation or distortion of the signals can lead to errors, reduced performance, or even complete failure of communication between devices. In the case of QSFP-DD, which supports data rates of up to 400 Gbps per port, ensuring signal integrity is particularly challenging due to the high data rates and the compact form factor of the module.

Feature Characteristics

The signal integrity involves addressing various factors such as impedance matching, jitter, noise, reflections, and equalization to ensure the accurate and reliable transmission of electrical signals in electronic systems.

Benefits

Optimizing signal integrity in QSFP-DD modules offers numerous benefits:

¹QSFP-DD stands for Quad Small Form Factor Pluggable Double Density. QSFP-DD modules provide a scalable, high-bandwidth solution for data center networking, enabling efficient data transmission and network performance in modern computing environments.

- Enhanced reliability
- High-speed data transmission
- Reduced latency
- Compatibility
- Longer reach
- Scalability
- Cost-efficiency
- Compliance assurance

Configuration

To configure Signal Integrity (SI¹) parameters like Rx Pre-Cursor Equalization, Rx Post-Cursor Equalization, Tx Equalization, and Rx Amplitude on a **QSFP-DD**² module, you usually interact with the management interface or CLI provided by the networking equipment hosting the module. This involves accessing the configuration settings specific to the QSFP-DD module within the device's interface.

Topology

In this topology, the Signal Integrity RTR1 to RTR2 interface configuration in QSFP-DD.

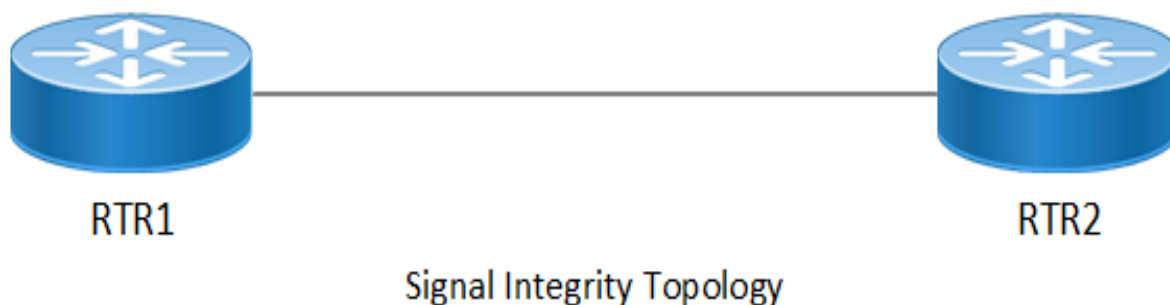

R1 Tx Equalization

For the Tx equalization configuration in R1 route, follow these steps:

1. To configure Tx equalization, execute the following command in the config mode.

```
R1(config)#qsfp-dd 11
R1(config-qsfp-dd)# tx-input eq-target 5
```

2. To configure, execute the following command.

```
R1(config-qsfp-dd)#commit
```

¹Signal integrity in networking refers to the reliability and fidelity of electrical signals as they propagate through various components of a network infrastructure.

²QSFP-DD stands for Quad Small Form Factor Pluggable Double Density. QSFP-DD modules provide a scalable, high-bandwidth solution for data center networking, enabling efficient data transmission and network performance in modern computing environments.

Validation

To validate the Tx equalization configuration, use the following command.

```
OcNOS#show qsf-p-dd 11 si status
```

Port Number : 11

Parameter	Lane	User Config	H/W Config
Tx Equalization	1	5	5
	2	5	5
	3	5	5
	4	5	5
	5	5	5
	6	5	5
	7	5	5
	8	5	5
Rx Pre-Cursor Eq	1	None	0
	2	None	0
	3	None	0
	4	None	0
	5	None	0
	6	None	0
	7	None	0
	8	None	0
Rx Amplitude	1	None	2
	2	None	2
	3	None	2
	4	None	2
	5	None	2
	6	None	2
	7	None	2
	8	None	2
Tx CDR Bypass	1	None	Disabled
	2	None	Disabled
	3	None	Disabled
	4	None	Disabled
	5	None	Disabled
	6	None	Disabled
	7	None	Disabled
	8	None	Disabled
Rx CDR Bypass	1	None	Disabled
	2	None	Disabled
	3	None	Disabled
	4	None	Disabled
	5	None	Disabled
	6	None	Disabled
	7	None	Disabled
	8	None	Disabled

R2 Tx Equalization

For the Tx equalization configuration in R2 route, follow these steps:

1. To configure Tx equalization, execute the following command in the config mode.

```
R2(config)#qsf-p-dd 11
R2(config-qsf-p-dd)# tx-input eq-target 5
```

2. To configure, execute the following command.

```
R2 (config-qsfp-dd) #commit
```

Validation

To validate the Tx equalization configuration, use the following command.

```
OcnOS#show qsfp-dd 11 si status
Port Number          : 11
-----
```

Parameter	Lane	User Config	H/W Config
Tx Equalization	1	5	5
	2	5	5
	3	5	5
	4	5	5
	5	5	5
	6	5	5
	7	5	5
	8	5	5
Rx Pre-Cursor Eq	1	None	0
	2	None	0
	3	None	0
	4	None	0
	5	None	0
	6	None	0
	7	None	0
	8	None	0
Rx Amplitude	1	None	2
	2	None	2
	3	None	2
	4	None	2
	5	None	2
	6	None	2
	7	None	2
	8	None	2
Tx CDR Bypass	1	None	Disabled
	2	None	Disabled
	3	None	Disabled
	4	None	Disabled
	5	None	Disabled
	6	None	Disabled
	7	None	Disabled
	8	None	Disabled
Rx CDR Bypass	1	None	Disabled
	2	None	Disabled
	3	None	Disabled
	4	None	Disabled
	5	None	Disabled
	6	None	Disabled
	7	None	Disabled
	8	None	Disabled

Tx Equalization Unconfiguration

For the Tx equalization unconfiguration in R2 route, follow these steps:

1. To unconfigure Tx equalization, execute the following command in the config mode.

```
R2(config)#qsfp-dd 11
R2(config-qsfp-dd)# no tx-input eq-target 5
```

2. To unconfigure, execute the following command.

```
R2(config-qsfp-dd)#commit
```

Tx Equalization Unconfiguration Validation

To validate the Tx equalization unconfiguration, use the following command.

```
OcNOS#show qsfp-dd 11 si status
```

```
Port Number          : 11
```

Parameter	Lane	User Config	H/W Config
Tx Equalization	1	None	0
	2	None	0
	3	None	0
	4	None	0
	5	None	0
	6	None	0
	7	None	0
	8	None	0
Rx Pre-Cursor Eq	1	None	0
	2	None	0
	3	None	0
	4	None	0
	5	None	0
	6	None	0
	7	None	0
	8	None	0
Rx Amplitude	1	None	2
	2	None	2
	3	None	2
	4	None	2
	5	None	2
	6	None	2
	7	None	2
	8	None	2
Tx CDR Bypass	1	None	Disabled
	2	None	Disabled
	3	None	Disabled
	4	None	Disabled
	5	None	Disabled
	6	None	Disabled
	7	None	Disabled
	8	None	Disabled
Rx CDR Bypass	1	None	Disabled
	2	None	Disabled
	3	None	Disabled
	4	None	Disabled
	5	None	Disabled
	6	None	Disabled
	7	None	Disabled
	8	None	Disabled

To configure the Tx Equalization on any specific host lanes, do the following configuration.

R1 Tx Equalization

For the Tx equalization configuration on any specific host lanes, follow these steps:

1. To configure Tx equalization on any specific host lanes, execute the following command in the config mode.

```
R1(config)#qsfp-dd 11
R1(config-qsfp-dd)# host-lane 1
R1(config-qsfp-dd)# tx-input eq-target 7
```

2. To configure, execute the following command.

```
R1(config-qsfp-dd)#commit
```

Validation

To validate the Tx equalization configuration, use the following command.

```
OcNOS#show qsfp-dd 11 si status
```

```
Port Number          : 11
```

Parameter	Lane	User Config	H/W Config

Tx Equalization	1	7	7
	2	5	5
	3	5	5
	4	5	5
	5	5	5
	6	5	5
	7	5	5
	8	5	5

Rx Pre-Cursor Eq	1	None	0
	2	None	0
	3	None	0
	4	None	0
	5	None	0
	6	None	0
	7	None	0
	8	None	0

Rx Amplitude	1	None	2
	2	None	2
	3	None	2
	4	None	2
	5	None	2
	6	None	2
	7	None	2
	8	None	2

Tx CDR Bypass	1	None	Disabled
	2	None	Disabled
	3	None	Disabled
	4	None	Disabled
	5	None	Disabled
	6	None	Disabled
	7	None	Disabled
	8	None	Disabled

Rx CDR Bypass	1	None	Disabled
	2	None	Disabled
	3	None	Disabled
	4	None	Disabled
	5	None	Disabled
	6	None	Disabled

	7	None	Disabled	
	8	None	Disabled	

R2 Tx Equalization

For the Tx equalization configuration in R2 route, follow these steps:

1. To configure Tx equalization, execute the following command in the config mode.

```
R2(config)#qsfdd 11R2(config-qsfdd)# host-lane 1
R2(config-qsfdd)# tx-input eq-target 7
```

2. To configure, execute the following command.

```
R2(config-qsfdd)#commit
```

Validation

To validate the Tx equalization configuration, use the following command.

```
OcNOS#show qsfdd 11 si status
```

Port Number : 11

Parameter	Lane	User Config	H/W Config
Tx Equalization	1	7	7
	2	5	5
	3	5	5
	4	5	5
	5	5	5
	6	5	5
	7	5	5
	8	5	5
Rx Pre-Cursor Eq	1	None	0
	2	None	0
	3	None	0
	4	None	0
	5	None	0
	6	None	0
	7	None	0
	8	None	0
Rx Amplitude	1	None	2
	2	None	2
	3	None	2
	4	None	2
	5	None	2
	6	None	2
	7	None	2
	8	None	2
Tx CDR Bypass	1	None	Disabled
	2	None	Disabled
	3	None	Disabled
	4	None	Disabled
	5	None	Disabled
	6	None	Disabled
	7	None	Disabled
	8	None	Disabled
Rx CDR Bypass	1	None	Disabled
	2	None	Disabled

	3	None	Disabled	
	4	None	Disabled	
	5	None	Disabled	
	6	None	Disabled	
	7	None	Disabled	
	8	None	Disabled	

Tx Equalization Unconfiguration

For the Tx equalization unconfiguration on any specific host lanes, follow these steps:

1. To unconfigure Tx equalization on any specific host lanes, execute the following command in the config mode.

```
R1(config)#qsfp-dd 11
R1(config-qsfp-dd)# host-lane 1
R1(config-qsfp-dd)# no tx-input eq-target 7
```

2. To unconfigure, execute the following command.

```
R1(config-qsfp-dd)#commit
```

Tx Equalization Unconfiguration Validation

To validate the Tx equalization unconfiguration, use the following command.

```
OcNOS#show qsfp-dd 11 si status
```

```
Port Number : 11
```

Parameter	Lane	User Config	H/W Config
Tx Equalization	1	5	5
	2	5	5
	3	5	5
	4	5	5
	5	5	5
	6	5	5
	7	5	5
	8	5	5
Rx Pre-Cursor Eq	1	None	0
	2	None	0
	3	None	0
	4	None	0
	5	None	0
	6	None	0
	7	None	0
	8	None	0
Rx Amplitude	1	None	2
	2	None	2
	3	None	2
	4	None	2
	5	None	2
	6	None	2
	7	None	2
	8	None	2
Tx CDR Bypass	1	None	Disabled
	2	None	Disabled
	3	None	Disabled
	4	None	Disabled
	5	None	Disabled

	6	None	Disabled	
	7	None	Disabled	
	8	None	Disabled	

Rx CDR Bypass	1	None	Disabled	
	2	None	Disabled	
	3	None	Disabled	
	4	None	Disabled	
	5	None	Disabled	
	6	None	Disabled	
	7	None	Disabled	
	8	None	Disabled	

R1 Rx Amplitude

Use this command to configure the Rx Amplitude on the **QSFP-DD**¹ module on all eight host lanes, follow these steps.

1. To configure Rx amplitude, execute the following command in the config mode:

```
R1(config)#qsfp-dd 11
R1(config-qsfp-dd)# rx-output amp-target 2
```

2. To configure, execute the following command.

```
R1(config-qsfp-dd)#commit
```

Validation

To validate the Rx amplitude configuration, use the following command.

```
OcNOS#show qsfp-dd 11 si status

Port Number           : 11

-----
Parameter            | Lane | User Config | H/W Config |
-----
Tx Equalization       | 1    | 7            | 7           |
                     | 2    | 5            | 5           |
                     | 3    | 5            | 5           |
                     | 4    | 5            | 5           |
                     | 5    | 5            | 5           |
                     | 6    | 5            | 5           |
                     | 7    | 5            | 5           |
                     | 8    | 5            | 5           |
-----
Rx Pre-Cursor Eq     | 1    | None         | 0           |
                     | 2    | None         | 0           |
                     | 3    | None         | 0           |
                     | 4    | None         | 0           |
                     | 5    | None         | 0           |
                     | 6    | None         | 0           |
                     | 7    | None         | 0           |
                     | 8    | None         | 0           |
-----
Rx Amplitude         | 1    | 2            | 2           |
                     | 2    | 2            | 2           |
                     | 3    | 2            | 2           |
                     | 4    | 2            | 2           |
                     | 5    | 2            | 2           |
                     | 6    | 2            | 2           |
                     |
```

¹QSFP-DD stands for Quad Small Form Factor Pluggable Double Density. QSFP-DD modules provide a scalable, high-bandwidth solution for data center networking, enabling efficient data transmission and network performance in modern computing environments.

	7	2	2	
	8	2	2	

Tx CDR Bypass	1	None	Disabled	
	2	None	Disabled	
	3	None	Disabled	
	4	None	Disabled	
	5	None	Disabled	
	6	None	Disabled	
	7	None	Disabled	
	8	None	Disabled	

Rx CDR Bypass	1	None	Disabled	
	2	None	Disabled	
	3	None	Disabled	
	4	None	Disabled	
	5	None	Disabled	
	6	None	Disabled	
	7	None	Disabled	
	8	None	Disabled	

OcNOS#

R2 Rx Amplitude

Use this command to configure the Rx Amplitude on the **QSFP-DD**¹ module on all eight host lanes, follow these steps.

1. To configure Rx amplitude, execute the following command in the config mode.

```
R2 (config) #qsfp-dd 11
R2 (config-qsfp-dd) # rx-output amp-target 2
```

2. To configure, execute the following command.

```
R2 (config-qsfp-dd) #commit
```

Validation

To validate the Rx amplitude configuration, use the following command.

```
OcNOS#show qsfp-dd 11 si status
```

Port Number : 11

Parameter	Lane	User Config	H/W Config

Tx Equalization	1	7	7
	2	5	5
	3	5	5
	4	5	5
	5	5	5
	6	5	5
	7	5	5
	8	5	5

Rx Pre-Cursor Eq	1	None	0
	2	None	0
	3	None	0
	4	None	0
	5	None	0

¹QSFP-DD stands for Quad Small Form Factor Pluggable Double Density. QSFP-DD modules provide a scalable, high-bandwidth solution for data center networking, enabling efficient data transmission and network performance in modern computing environments.

	6	None	0	
	7	None	0	
	8	None	0	

Rx Amplitude	1	2	2	
	2	2	2	
	3	2	2	
	4	2	2	
	5	2	2	
	6	2	2	
	7	2	2	
	8	2	2	

Tx CDR Bypass	1	None	Disabled	
	2	None	Disabled	
	3	None	Disabled	
	4	None	Disabled	
	5	None	Disabled	
	6	None	Disabled	
	7	None	Disabled	
	8	None	Disabled	

Rx CDR Bypass	1	None	Disabled	
	2	None	Disabled	
	3	None	Disabled	
	4	None	Disabled	
	5	None	Disabled	
	6	None	Disabled	
	7	None	Disabled	
	8	None	Disabled	

OcNOS#

Rx Amplitude Unconfiguration

For the Rx amplitude unconfiguration, follow these steps.

1. To unconfigure Rx amplitude, execute the following command in the config mode.

```
R2(config)#qsfp-dd 11
R2(config-qsfp-dd)# no rx-output amp-target 2
```

2. To configure, execute the following command.

```
R2(config-qsfp-dd)#commit
```

Rx Amplitude Unconfiguration Validation

To validate the Rx amplitude unconfiguration, use the following command.

```
OcNOS#sh qsfp-dd 11 advertisement si
```

```
Port Number : 11
```

Parameter	Lane	User Config	H/W Config	

Tx Equalization	1	None	0	
	2	None	0	
	3	None	0	
	4	None	0	
	5	None	0	
	6	None	0	
	7	None	0	
	8	None	0	

```

-----
Rx Pre-Cursor Eq | 1 | None | 6 |
                  | 2 | None | 6 |
                  | 3 | None | 6 |
                  | 4 | None | 6 |
                  | 5 | None | 6 |
                  | 6 | None | 6 |
                  | 7 | None | 6 |
                  | 8 | None | 6 |
-----
Rx Amplitude     | 1 | None | 3 |
                  | 2 | None | 3 |
                  | 3 | None | 3 |
                  | 4 | None | 3 |
                  | 5 | None | 3 |
                  | 6 | None | 3 |
                  | 7 | None | 3 |
                  | 8 | None | 3 |
-----
Tx CDR Bypass   | 1 | None | Disabled |
                  | 2 | None | Disabled |
                  | 3 | None | Disabled |
                  | 4 | None | Disabled |
                  | 5 | None | Disabled |
                  | 6 | None | Disabled |
                  | 7 | None | Disabled |
                  | 8 | None | Disabled |
-----
Rx CDR Bypass   | 1 | None | Disabled |
                  | 2 | None | Disabled |
                  | 3 | None | Disabled |
                  | 4 | None | Disabled |
                  | 5 | None | Disabled |
                  | 6 | None | Disabled |
                  | 7 | None | Disabled |
                  | 8 | None | Disabled |
-----

```

To configure the Rx Amplitude on any specific host lanes, do the following configuration.

R1 Rx Amplitude

Use this command to configure the Rx Amplitude on the **QSFP-DD¹** module on any specific host lanes, follow these steps.

1. To configure Rx amplitude, execute the following command in the config mode.

```
R1(config)#qsfp-dd 11
R1(config-qsfp-dd)# host-lane 1
R1(config-qsfp-dd-host)# rx-output amp-target 3
```

2. To configure, execute the following command.

```
R1(config-qsfp-dd)#commit
```

Validation

To validate the Rx amplitude configuration, use the following command.

```
OcNOS#show qsfp-dd 11 si status
```

¹QSFP-DD stands for Quad Small Form Factor Pluggable Double Density. QSFP-DD modules provide a scalable, high-bandwidth solution for data center networking, enabling efficient data transmission and network performance in modern computing environments.

Port Number : 11

Parameter	Lane	User Config	H/W Config
Tx Equalization	1	7	7
	2	5	5
	3	5	5
	4	5	5
	5	5	5
	6	5	5
	7	5	5
	8	5	5
Rx Pre-Cursor Eq	1	None	0
	2	None	0
	3	None	0
	4	None	0
	5	None	0
	6	None	0
	7	None	0
	8	None	0
Rx Amplitude	1	3	3
	2	2	2
	3	2	2
	4	2	2
	5	2	2
	6	2	2
	7	2	2
	8	2	2
Tx CDR Bypass	1	None	Disabled
	2	None	Disabled
	3	None	Disabled
	4	None	Disabled
	5	None	Disabled
	6	None	Disabled
	7	None	Disabled
	8	None	Disabled
Rx CDR Bypass	1	None	Disabled
	2	None	Disabled
	3	None	Disabled
	4	None	Disabled
	5	None	Disabled
	6	None	Disabled
	7	None	Disabled
	8	None	Disabled

R2 Rx Amplitude

Use this command to configure the Rx Amplitude on the **QSFP-DD**¹ module on all eight host lanes, follow these steps.

1. To configure Rx amplitude, execute the following command in the config mode.

```
R2(config)#qsfp-dd 11
R2(config-qsfp-dd)# host-lane 1
R2(config-qsfp-dd-host)# rx-output amp-target 3
```

2. To configure, execute the following command.

¹QSFP-DD stands for Quad Small Form Factor Pluggable Double Density. QSFP-DD modules provide a scalable, high-bandwidth solution for data center networking, enabling efficient data transmission and network performance in modern computing environments.

```
R2 (config-qsfp-dd) #commit
```

Validation

To validate the Rx amplitude configuration, use the following command.

```
OcNOS#show qsfp-dd 11 si status
```

```
Port Number          : 11
```

Parameter	Lane	User Config	H/W Config
Tx Equalization	1	7	7
	2	5	5
	3	5	5
	4	5	5
	5	5	5
	6	5	5
	7	5	5
	8	5	5
Rx Pre-Cursor Eq	1	None	0
	2	None	0
	3	None	0
	4	None	0
	5	None	0
	6	None	0
	7	None	0
	8	None	0
Rx Amplitude	1	3	3
	2	2	2
	3	2	2
	4	2	2
	5	2	2
	6	2	2
	7	2	2
	8	2	2
Tx CDR Bypass	1	None	Disabled
	2	None	Disabled
	3	None	Disabled
	4	None	Disabled
	5	None	Disabled
	6	None	Disabled
	7	None	Disabled
	8	None	Disabled
Rx CDR Bypass	1	None	Disabled
	2	None	Disabled
	3	None	Disabled
	4	None	Disabled
	5	None	Disabled
	6	None	Disabled
	7	None	Disabled
	8	None	Disabled

Rx Amplitude Unconfiguration

For the Rx amplitude unconfiguration, follow these steps.

1. To unconfigure Rx amplitude, execute the following command in the config mode.

```
R2(config)#qsfp-dd 11
R2(config-qsfp-dd)# host-lane 1
R2(config-qsfp-dd)# no rx-output amp-target 3
```

2. To configure, execute the following command.

```
R2(config-qsfp-dd)#commit
```

Rx Amplitude Unconfiguration Validation

To validate the Rx amplitude unconfiguration, use the following command.

```
OcNOS#sh qsfp-dd 11 advertisement si
Port Number          : 11

-----
Parameter           | Lane | User Config | H/W Config |
-----
Tx Equalization     | 1    | 7           | 7           |
                   | 2    | 5           | 5           |
                   | 3    | 5           | 5           |
                   | 4    | 5           | 5           |
                   | 5    | 5           | 5           |
                   | 6    | 5           | 5           |
                   | 7    | 5           | 5           |
                   | 8    | 5           | 5           |
-----
Rx Pre-Cursor Eq    | 1    | None        | 0           |
                   | 2    | None        | 0           |
                   | 3    | None        | 0           |
                   | 4    | None        | 0           |
                   | 5    | None        | 0           |
                   | 6    | None        | 0           |
                   | 7    | None        | 0           |
                   | 8    | None        | 0           |
-----
Rx Amplitude        | 1    | 2           | 2           |
                   | 2    | 2           | 2           |
                   | 3    | 2           | 2           |
                   | 4    | 2           | 2           |
                   | 5    | 2           | 2           |
                   | 6    | 2           | 2           |
                   | 7    | 2           | 2           |
                   | 8    | 2           | 2           |
-----
Tx CDR Bypass       | 1    | None        | Disabled    |
                   | 2    | None        | Disabled    |
                   | 3    | None        | Disabled    |
                   | 4    | None        | Disabled    |
                   | 5    | None        | Disabled    |
                   | 6    | None        | Disabled    |
                   | 7    | None        | Disabled    |
                   | 8    | None        | Disabled    |
-----
Rx CDR Bypass       | 1    | None        | Disabled    |
                   | 2    | None        | Disabled    |
                   | 3    | None        | Disabled    |
                   | 4    | None        | Disabled    |
                   | 5    | None        | Disabled    |
                   | 6    | None        | Disabled    |
                   | 7    | None        | Disabled    |
                   | 8    | None        | Disabled    |
-----
```

R1 Rx Pre-Cursor Eq

Use this command to configure the Rx Pre-Cursor Eq on the **QSFP-DD¹** module on all eight host lanes, follow these steps.

1. To configure Rx Pre-Cursor Eq, execute the following command in the config mode.

```
R1(config)#qsfp-dd 0
R1(config-qsfp-dd)# rx-output eq-pre-cursor-target 4
```

2. To configure, execute the following command.

```
R1(config-qsfp-dd)#commit
```

Validation

To validate the Rx Pre-Cursor Eq configuration, use the following command.

```
OcNOS#show qsfp-dd 0 si status
```

```
Port Number                : 0
```

Parameter	Lane	User Config	H/W Config
Rx Pre-Cursor Eq	1	4	4
	2	4	4
	3	4	4
	4	4	4
	5	4	4
	6	4	4
	7	4	4
	8	4	4
Rx Post-Cursor Eq	1	None	0
	2	None	0
	3	None	0
	4	None	0
	5	None	0
	6	None	0
	7	None	0
	8	None	0
Rx Amplitude	1	None	0
	2	None	0
	3	None	0
	4	None	0
	5	None	0
	6	None	0
	7	None	0
	8	None	0
Tx CDR Bypass	1	None	Disabled
	2	None	Disabled
	3	None	Disabled
	4	None	Disabled
	5	None	Disabled
	6	None	Disabled
	7	None	Disabled
	8	None	Disabled
Rx CDR Bypass	1	None	Disabled
	2	None	Disabled

¹QSFP-DD stands for Quad Small Form Factor Pluggable Double Density. QSFP-DD modules provide a scalable, high-bandwidth solution for data center networking, enabling efficient data transmission and network performance in modern computing environments.

```

| 3 | None | Disabled |
| 4 | None | Disabled |
| 5 | None | Disabled |
| 6 | None | Disabled |
| 7 | None | Disabled |
| 8 | None | Disabled |
-----

```

R2 Rx Pre-Cursor Eq

Use this command to configure the Rx Pre-Cursor Eq on the **QSFP-DD¹** module on all eight host lanes, follow these steps.

1. To configure Rx Pre-Cursor Eq, execute the following command in the config mode.

```

R2(config)#qsfp-dd 0
R2(config-qsfp-dd)# rx-output eq-pre-cursor-target 4

```

2. To configure, execute the following command.

```

R2(config-qsfp-dd)#commit

```

Validation

To validate the Rx Pre-Cursor Eq configuration, use the following command.

```

OcNOS#show qsfp-dd 0 si status

Port Number          : 0

-----
Parameter           | Lane | User Config | H/W Config |
-----
Rx Pre-Cursor Eq    | 1   | 4           | 4           |
                    | 2   | 4           | 4           |
                    | 3   | 4           | 4           |
                    | 4   | 4           | 4           |
                    | 5   | 4           | 4           |
                    | 6   | 4           | 4           |
                    | 7   | 4           | 4           |
                    | 8   | 4           | 4           |
-----
Rx Post-Cursor Eq   | 1   | None        | 0           |
                    | 2   | None        | 0           |
                    | 3   | None        | 0           |
                    | 4   | None        | 0           |
                    | 5   | None        | 0           |
                    | 6   | None        | 0           |
                    | 7   | None        | 0           |
                    | 8   | None        | 0           |
-----
Rx Amplitude        | 1   | None        | 0           |
                    | 2   | None        | 0           |
                    | 3   | None        | 0           |
                    | 4   | None        | 0           |
                    | 5   | None        | 0           |
                    | 6   | None        | 0           |
                    | 7   | None        | 0           |
                    | 8   | None        | 0           |
-----
Tx CDR Bypass       | 1   | None        | Disabled    |
                    | 2   | None        | Disabled    |

```

¹QSFP-DD stands for Quad Small Form Factor Pluggable Double Density. QSFP-DD modules provide a scalable, high-bandwidth solution for data center networking, enabling efficient data transmission and network performance in modern computing environments.

	3	None	Disabled	
	4	None	Disabled	
	5	None	Disabled	
	6	None	Disabled	
	7	None	Disabled	
	8	None	Disabled	

Rx CDR Bypass	1	None	Disabled	
	2	None	Disabled	
	3	None	Disabled	
	4	None	Disabled	
	5	None	Disabled	
	6	None	Disabled	
	7	None	Disabled	
	8	None	Disabled	

OcNOS#

Rx Pre-Cursor Eq Unconfiguration

Use this command to unconfigure the Rx Pre-Cursor Eq on the **QSFP-DD¹** module on all eight host lanes, follow these steps.

1. To unconfigure Rx Pre-Cursor Eq, execute the following command in the config mode.

```
R1(config)#qsfp-dd 0
R1(config-qsfp-dd)# no rx-output eq-pre-cursor-target 4
```

2. To unconfigure, execute the following command.

```
R1(config-qsfp-dd)#commit
```

Rx Pre-Cursor Eq Unconfiguration Validation

To validate the Rx Pre-Cursor Eq Unconfiguration, use the following command.

```
OcNOS#sh qsfp-dd 11 si status
```

```
Port Number : 11
```

Parameter	Lane	User Config	H/W Config

Rx Pre-Cursor Eq	1	None	0
	2	None	0
	3	None	0
	4	None	0
	5	None	0
	6	None	0
	7	None	0
	8	None	0

Rx Post-Cursor Eq	1	None	0
	2	None	0
	3	None	0
	4	None	0
	5	None	0
	6	None	0
	7	None	0
	8	None	0

Rx Amplitude	1	None	0

¹QSFP-DD stands for Quad Small Form Factor Pluggable Double Density. QSFP-DD modules provide a scalable, high-bandwidth solution for data center networking, enabling efficient data transmission and network performance in modern computing environments.

	2	None	0	
	3	None	0	
	4	None	0	
	5	None	0	
	6	None	0	
	7	None	0	
	8	None	0	

Tx CDR Bypass	1	None	Disabled	
	2	None	Disabled	
	3	None	Disabled	
	4	None	Disabled	
	5	None	Disabled	
	6	None	Disabled	
	7	None	Disabled	
	8	None	Disabled	

Rx CDR Bypass	1	None	Disabled	
	2	None	Disabled	
	3	None	Disabled	
	4	None	Disabled	
	5	None	Disabled	
	6	None	Disabled	
	7	None	Disabled	
	8	None	Disabled	

To configure the Rx Pre-Cursor Eq on any specific host lanes, do the following configuration.

R1 Rx Pre-Cursor Eq

Use this command to configure the Rx Pre-Cursor Eq on the **QSFP-DD¹** module on any specific host lanes, follow these steps.

1. To configure Rx Pre-Cursor Eq, execute the following command in the config mode.

```
R1(config)#qsfp-dd 0
R1(config-qsfp-dd)# host-lane 1
R1(config-qsfp-dd-host)# rx-output eq-pre-cursor-target 3
```

2. To configure, execute the following command.

```
R1(config-qsfp-dd)#commit
```

Validation

To validate the Rx Pre-Cursor Eq configuration, use the following command.

```
OcNOS#show qsfp-dd 0 si status

Port Number           : 0

-----
Parameter | Lane | User Config | H/W Config |
-----
Rx Pre-Cursor Eq | 1 | 3 | 3 |
                | 2 | 4 | 4 |
                | 3 | 4 | 4 |
                | 4 | 4 | 4 |
                | 5 | 4 | 4 |
-----
```

¹QSFP-DD stands for Quad Small Form Factor Pluggable Double Density. QSFP-DD modules provide a scalable, high-bandwidth solution for data center networking, enabling efficient data transmission and network performance in modern computing environments.

	6	4	4	
	7	4	4	
	8	4	4	

Rx Post-Cursor Eq	1	None	0	
	2	None	0	
	3	None	0	
	4	None	0	
	5	None	0	
	6	None	0	
	7	None	0	
	8	None	0	

Rx Amplitude	1	None	0	
	2	None	0	
	3	None	0	
	4	None	0	
	5	None	0	
	6	None	0	
	7	None	0	
	8	None	0	

Tx CDR Bypass	1	None	Disabled	
	2	None	Disabled	
	3	None	Disabled	
	4	None	Disabled	
	5	None	Disabled	
	6	None	Disabled	
	7	None	Disabled	
	8	None	Disabled	

Rx CDR Bypass	1	None	Disabled	
	2	None	Disabled	
	3	None	Disabled	
	4	None	Disabled	
	5	None	Disabled	
	6	None	Disabled	
	7	None	Disabled	
	8	None	Disabled	

R2 Rx Pre-Cursor Eq

Use this command to configure the Rx Pre-Cursor Eq on the **QSFP-DD**¹ module on any specific host lanes, follow these steps.

1. To configure Rx Pre-Cursor Eq, execute the following command in the config mode.

```
R2(config)#qsfp-dd 0
R2(config-qsfp-dd)# host-lane 1
R2(config-qsfp-dd-host)# rx-output eq-pre-cursor-target 3
```

2. To configure, execute the following command.

```
R2(config-qsfp-dd)#commit
```

Validation

To validate the Rx Pre-Cursor Eq configuration, use the following command.

```
OcNOS#show qsfp-dd 0 si status
```

```
Port Number           : 0
```

¹QSFP-DD stands for Quad Small Form Factor Pluggable Double Density. QSFP-DD modules provide a scalable, high-bandwidth solution for data center networking, enabling efficient data transmission and network performance in modern computing environments.

Parameter	Lane	User Config	H/W Config
Rx Pre-Cursor Eq	1	3	3
	2	4	4
	3	4	4
	4	4	4
	5	4	4
	6	4	4
	7	4	4
	8	4	4
Rx Post-Cursor Eq	1	None	0
	2	None	0
	3	None	0
	4	None	0
	5	None	0
	6	None	0
	7	None	0
	8	None	0
Rx Amplitude	1	None	0
	2	None	0
	3	None	0
	4	None	0
	5	None	0
	6	None	0
	7	None	0
	8	None	0
Tx CDR Bypass	1	None	Disabled
	2	None	Disabled
	3	None	Disabled
	4	None	Disabled
	5	None	Disabled
	6	None	Disabled
	7	None	Disabled
	8	None	Disabled
Rx CDR Bypass	1	None	Disabled
	2	None	Disabled
	3	None	Disabled
	4	None	Disabled
	5	None	Disabled
	6	None	Disabled
	7	None	Disabled
	8	None	Disabled

Rx Pre-Cursor Eq Unconfiguration

Use this command to unconfigure the Rx Pre-Cursor Eq on the **QSFP-DD**¹ module on any specific host lanes, follow these steps.

1. To unconfigure Rx Pre-Cursor Eq, execute the following command in the config mode.

```
R1(config)#qsfp-dd 0
R1(config-qsfp-dd)# host-lane 1
R1(config-qsfp-dd-host)# no rx-output eq-pre-cursor-target 3
```

2. To unconfigure, execute the following command.

¹QSFP-DD stands for Quad Small Form Factor Pluggable Double Density. QSFP-DD modules provide a scalable, high-bandwidth solution for data center networking, enabling efficient data transmission and network performance in modern computing environments.

```
R1 (config-qsfp-dd) #commit
```

Rx Pre-Cursor Eq Validation

To validate the Rx Pre-Cursor Eq unconfigure, use the following command.

```
OcnOS#show qsfp-dd 0 si status
```

```
Port Number          : 0
```

Parameter	Lane	User Config	H/W Config
Rx Pre-Cursor Eq	1	4	4
	2	4	4
	3	4	4
	4	4	4
	5	4	4
	6	4	4
	7	4	4
	8	4	4
Rx Post-Cursor Eq	1	None	0
	2	None	0
	3	None	0
	4	None	0
	5	None	0
	6	None	0
	7	None	0
	8	None	0
Rx Amplitude	1	None	0
	2	None	0
	3	None	0
	4	None	0
	5	None	0
	6	None	0
	7	None	0
	8	None	0
Tx CDR Bypass	1	None	Disabled
	2	None	Disabled
	3	None	Disabled
	4	None	Disabled
	5	None	Disabled
	6	None	Disabled
	7	None	Disabled
	8	None	Disabled
Rx CDR Bypass	1	None	Disabled
	2	None	Disabled
	3	None	Disabled
	4	None	Disabled
	5	None	Disabled
	6	None	Disabled
	7	None	Disabled
	8	None	Disabled

R1 Rx Post-Cursor Eq

Use this command to configure the Rx Post-Cursor Eq on the **QSFP-DD**¹ module on all eight host lanes, follow these steps.

1. To configure Rx Post-Cursor Eq, execute the following command in the config mode.

```
R1(config)#qsfp-dd 0
R1(config-qsfp-dd)# rx-output eq-pre-cursor-target 4
```

2. To configure, execute the following command.

```
R1(config-qsfp-dd)#commit
```

Validation

To validate the Rx Post-Cursor Eq configuration, use the following command.

```
OcNOS#show qsfp-dd 0 si status
```

```
Port Number          : 0
```

Parameter	Lane	User Config	H/W Config
Rx Pre-Cursor Eq	1	3	3
	2	4	4
	3	4	4
	4	4	4
	5	4	4
	6	4	4
	7	4	4
	8	4	4
Rx Post-Cursor Eq	1	4	4
	2	4	4
	3	4	4
	4	4	4
	5	4	4
	6	4	4
	7	4	4
	8	4	4
Rx Amplitude	1	None	0
	2	None	0
	3	None	0
	4	None	0
	5	None	0
	6	None	0
	7	None	0
	8	None	0
Tx CDR Bypass	1	None	Disabled
	2	None	Disabled
	3	None	Disabled
	4	None	Disabled
	5	None	Disabled
	6	None	Disabled
	7	None	Disabled
	8	None	Disabled
Rx CDR Bypass	1	None	Disabled
	2	None	Disabled

¹QSFP-DD stands for Quad Small Form Factor Pluggable Double Density. QSFP-DD modules provide a scalable, high-bandwidth solution for data center networking, enabling efficient data transmission and network performance in modern computing environments.

```

| 3 | None | Disabled |
| 4 | None | Disabled |
| 5 | None | Disabled |
| 6 | None | Disabled |
| 7 | None | Disabled |
| 8 | None | Disabled |
-----

```

R2 Rx Post-Cursor Eq

Use this command to configure the Rx Post-Cursor Eq on the **QSFP-DD**¹ module on all eight host lanes, follow these steps.

1. To configure Rx Post-Cursor Eq, execute the following command in the config mode.

```

R2(config)#qsfp-dd 0
R2(config-qsfp-dd)# rx-output eq-pre-cursor-target 4

```

2. To configure, execute the following command.

```

R2(config-qsfp-dd)#commit

```

Validation

To validate the Rx Post-Cursor Eq configuration, use the following command.

```

OcNOS#show qsfp-dd 0 si status

Port Number           : 0

-----
Parameter | Lane | User Config | H/W Config |
-----
Rx Pre-Cursor Eq | 1 | 3 | 3 |
                | 2 | 4 | 4 |
                | 3 | 4 | 4 |
                | 4 | 4 | 4 |
                | 5 | 4 | 4 |
                | 6 | 4 | 4 |
                | 7 | 4 | 4 |
                | 8 | 4 | 4 |
-----
Rx Post-Cursor Eq | 1 | 4 | 4 |
                | 2 | 4 | 4 |
                | 3 | 4 | 4 |
                | 4 | 4 | 4 |
                | 5 | 4 | 4 |
                | 6 | 4 | 4 |
                | 7 | 4 | 4 |
                | 8 | 4 | 4 |
-----
Rx Amplitude | 1 | None | 0 |
                | 2 | None | 0 |
                | 3 | None | 0 |
                | 4 | None | 0 |
                | 5 | None | 0 |
                | 6 | None | 0 |
                | 7 | None | 0 |
                | 8 | None | 0 |
-----
Tx CDR Bypass | 1 | None | Disabled |
                | 2 | None | Disabled |
                | 3 | None | Disabled |

```

¹QSFP-DD stands for Quad Small Form Factor Pluggable Double Density. QSFP-DD modules provide a scalable, high-bandwidth solution for data center networking, enabling efficient data transmission and network performance in modern computing environments.

	4	None	Disabled	
	5	None	Disabled	
	6	None	Disabled	
	7	None	Disabled	
	8	None	Disabled	

Rx CDR Bypass	1	None	Disabled	
	2	None	Disabled	
	3	None	Disabled	
	4	None	Disabled	
	5	None	Disabled	
	6	None	Disabled	
	7	None	Disabled	
	8	None	Disabled	

R1 Rx Post-Cursor Eq Unconfiguration

Use this command to unconfigure the Rx Post-Cursor Eq on the **QSFP-DD**¹ module on all eight host lanes, follow these steps.

1. To unconfigure Rx Post-Cursor Eq, execute the following command in the config mode.

```
R1(config)#qsfp-dd 0
R1(config-qsfp-dd)# rx-output eq-pre-cursor-target 4
```

2. To unconfigure, execute the following command.

```
R1(config-qsfp-dd)#commit
```

R1 Rx Post-Cursor Eq Unconfiguration Validation

To validate the Rx Post-Cursor Eq unconfigure, use the following command.

```
OcNOS#show qsfp-dd 0 advertisement si

Port Number          : 0

-----
Parameter           | Lane | User Config | H/W Config |
-----
Rx Pre-Cursor Eq    | 1    | None        | 0           |
                    | 2    | None        | 0           |
                    | 3    | None        | 0           |
                    | 4    | None        | 0           |
                    | 5    | None        | 0           |
                    | 6    | None        | 0           |
                    | 7    | None        | 0           |
                    | 8    | None        | 0           |
-----
Rx Post-Cursor Eq   | 1    | None        | 0           |
                    | 2    | None        | 0           |
                    | 3    | None        | 0           |
                    | 4    | None        | 0           |
                    | 5    | None        | 0           |
                    | 6    | None        | 0           |
                    | 7    | None        | 0           |
                    | 8    | None        | 0           |
-----
Rx Amplitude        | 1    | None        | 0           |
                    | 2    | None        | 0           |
                    | 3    | None        | 0           |
                    | 4    | None        | 0           |
```

¹QSFP-DD stands for Quad Small Form Factor Pluggable Double Density. QSFP-DD modules provide a scalable, high-bandwidth solution for data center networking, enabling efficient data transmission and network performance in modern computing environments.

	5	None	0	
	6	None	0	
	7	None	0	
	8	None	0	

Tx CDR Bypass	1	None	Disabled	
	2	None	Disabled	
	3	None	Disabled	
	4	None	Disabled	
	5	None	Disabled	
	6	None	Disabled	
	7	None	Disabled	
	8	None	Disabled	

Rx CDR Bypass	1	None	Disabled	
	2	None	Disabled	
	3	None	Disabled	
	4	None	Disabled	
	5	None	Disabled	
	6	None	Disabled	
	7	None	Disabled	
	8	None	Disabled	

OcNOS#

To configure the Rx Post-Cursor Eq on any specific host lanes, do the following configuration.

R1 Rx Post-Cursor Eq

Use this command to configure the Rx Post-Cursor Eq on the **QSFP-DD**¹ module on any specific host lanes, follow these steps.

1. To configure Rx Post-Cursor Eq, execute the following command in the config mode.

```
R1(config)#qsfp-dd 0
R1(config-qsfp-dd)# host-lane 1
R1(config-qsfp-dd-host)# rx-output eq-pre-cursor-target 3
```

2. To configure, execute the following command.

```
R1(config-qsfp-dd)#commit
```

Validation

To validate the Rx Post-Cursor Eq configuration, use the following command.

```
OcNOS#show qsfp-dd 0 si status

Port Number           : 0

-----
Parameter            | Lane | User Config | H/W Config |
-----
Rx Pre-Cursor Eq    | 1    | 3           | 3           |
                    | 2    | 4           | 4           |
                    | 3    | 4           | 4           |
                    | 4    | 4           | 4           |
                    | 5    | 4           | 4           |
                    | 6    | 4           | 4           |
                    | 7    | 4           | 4           |
                    | 8    | 4           | 4           |
-----
```

¹QSFP-DD stands for Quad Small Form Factor Pluggable Double Density. QSFP-DD modules provide a scalable, high-bandwidth solution for data center networking, enabling efficient data transmission and network performance in modern computing environments.

Rx Post-Cursor Eq	1	3	3	
	2	4	4	
	3	4	4	
	4	4	4	
	5	4	4	
	6	4	4	
	7	4	4	
	8	4	4	

Rx Amplitude	1	None	0	
	2	None	0	
	3	None	0	
	4	None	0	
	5	None	0	
	6	None	0	
	7	None	0	
	8	None	0	

Tx CDR Bypass	1	None	Disabled	
	2	None	Disabled	
	3	None	Disabled	
	4	None	Disabled	
	5	None	Disabled	
	6	None	Disabled	
	7	None	Disabled	
	8	None	Disabled	

Rx CDR Bypass	1	None	Disabled	
	2	None	Disabled	
	3	None	Disabled	
	4	None	Disabled	
	5	None	Disabled	
	6	None	Disabled	
	7	None	Disabled	
	8	None	Disabled	

R2 Rx Post-Cursor Eq

Use this command to configure the Rx Post-Cursor Eq on the **QSFP-DD**¹ module on any specific host lanes, follow these steps.

1. To configure Rx Post-Cursor Eq, execute the following command in the config mode.

```
R2(config)#qsfp-dd 0
R2(config-qsfp-dd)# host-lane 1
R2(config-qsfp-dd-host)# rx-output eq-post-cursor-target 3
```

2. To configure, execute the following command.

```
R2(config-qsfp-dd)#commit
```

Validation

To validate the Rx Post-Cursor Eq configuration, use the following command.

```
OcNOS#show qsfp-dd 0 si status

Port Number           : 0

-----
Parameter            | Lane | User Config | H/W Config |
-----
```

¹QSFP-DD stands for Quad Small Form Factor Pluggable Double Density. QSFP-DD modules provide a scalable, high-bandwidth solution for data center networking, enabling efficient data transmission and network performance in modern computing environments.

Rx Pre-Cursor Eq	1	3	3	
	2	4	4	
	3	4	4	
	4	4	4	
	5	4	4	
	6	4	4	
	7	4	4	
	8	4	4	

Rx Post-Cursor Eq	1	4	4	
	2	4	4	
	3	4	4	
	4	4	4	
	5	4	4	
	6	4	4	
	7	4	4	
	8	4	4	

Rx Amplitude	1	None	0	
	2	None	0	
	3	None	0	
	4	None	0	
	5	None	0	
	6	None	0	
	7	None	0	
	8	None	0	

Tx CDR Bypass	1	None	Disabled	
	2	None	Disabled	
	3	None	Disabled	
	4	None	Disabled	
	5	None	Disabled	
	6	None	Disabled	
	7	None	Disabled	
	8	None	Disabled	

Rx CDR Bypass	1	None	Disabled	
	2	None	Disabled	
	3	None	Disabled	
	4	None	Disabled	
	5	None	Disabled	
	6	None	Disabled	
	7	None	Disabled	
	8	None	Disabled	

R1 Rx Post-Cursor Eq Unconfiguration

Use this command to unconfigure the Rx Post-Cursor Eq on the **QSFP-DD**¹ module on any specific host lanes, follow these steps.

1. To unconfigure Rx Post-Cursor Eq, execute the following command in the config mode.

```
R1(config)#qsfp-dd 0
R1(config-qsfp-dd)# host-lane 1
R1(config-qsfp-dd-host)# rx-output eq-pre-cursor-target 3
```

2. To unconfigure, execute the following command.

```
R1(config-qsfp-dd)#commit
```

¹QSFP-DD stands for Quad Small Form Factor Pluggable Double Density. QSFP-DD modules provide a scalable, high-bandwidth solution for data center networking, enabling efficient data transmission and network performance in modern computing environments.

R1 Rx Post-Cursor Eq Unconfiguration Validation

To validate the Rx Post-Cursor Eq unconfiguration, use the following command.

```
OcNOS#show qsf-p-dd 0 advertisement si
```

Port Number : 0

Parameter	Lane	User Config	H/W Config
Rx Pre-Cursor Eq	1	3	3
	2	4	4
	3	4	4
	4	4	4
	5	4	4
	6	4	4
	7	4	4
	8	4	4
Rx Post-Cursor Eq	1	4	4
	2	4	4
	3	4	4
	4	4	4
	5	4	4
	6	4	4
	7	4	4
	8	4	4
Rx Amplitude	1	None	0
	2	None	0
	3	None	0
	4	None	0
	5	None	0
	6	None	0
	7	None	0
	8	None	0
Tx CDR Bypass	1	None	Disabled
	2	None	Disabled
	3	None	Disabled
	4	None	Disabled
	5	None	Disabled
	6	None	Disabled
	7	None	Disabled
	8	None	Disabled
Rx CDR Bypass	1	None	Disabled
	2	None	Disabled
	3	None	Disabled
	4	None	Disabled
	5	None	Disabled
	6	None	Disabled
	7	None	Disabled
	8	None	Disabled

400G PM Alarm

Overview

The 400G PM alarm monitors and detects performance issues like the bit error rate and signal power in the network. This feature extends OcNOS performance-related monitoring capabilities and provides additional performance monitors and alarms.

400G coherent module¹ is a high-speed optical transceiver capable of transferring data long-distance with high performance. Its compatibility with single-mode optical fiber makes a robust combination in delivering a high-quality network transmission.

Feature Characteristics

Access the additional set of 400G performance monitoring parameters, such as Transmitter **FEC**² Detected Degrade (Tx **FDD**³), Transmitter FEC Excessive Degrade (Tx **FED**⁴), Receiver FEC Detected Degrade (Rx FDD), and Receiver FEC Excessive Degrade (Rx FED), to receive an automatic alarm notification on the CLI interface, via an SNMP trap, or through the Netconf interface. The automatic alarm is triggered when the monitored parameter crosses the configured value.

For 400G coherent modules, use this feature to configure custom thresholds for Tx FDD, Tx FED, Rx FDD, Rx FED, Tx Power, Rx Total Power, and Rx Signal Power through a new set of CLI configuration commands and Netconf interface.



Note: Configuration of the threshold value is not possible through SNMP.

Benefits

The capability of this feature to configure the alarm threshold allows customization based on the network requirements and expected error rates. If the signal power exceeds the configured threshold value, it sends a notification to take action that prevents the receiving devices from potential damage.

Prerequisites

The availability of specific parameters or flags is vendor-specific, so read the 400G transceiver data-sheet to determine the available parameters or flags.

¹400G coherent module is a high-speed optical transceiver capable of transferring data long-distance with high performance. Its compatibility with single-mode optical fiber makes a robust combination in delivering a high-quality network transmission.

²FEC is a technique that detects and corrects errors during data transmission to maintain the reliability of the communication system.

³FEC Detected Degrade suggests that the FEC has detected errors in data transmission. The alarm notification is triggered if the average BER exceeds the configured FDD value.

⁴FEC Excessive Degrade suggests that the FEC has detected very high errors in data transmission. FED is a more severe error condition than FDD and needs more attention. The alarm notification is triggered if the average BER exceeds the configured FED value.

Configuration

This section shows the configuration of the 400G PM Alarm.

Topology

R1 is connected to the R2 by 400G ZR/ZR+ transceiver. The interface cd 10 and cd20 are 400G interfaces where the 400G ZR/ZR+ transceiver is connected. Cd10 is the host interface and here the configuration of the threshold value for the host-lane occurs. In cd20 interface, we can configure the media-lane threshold value.

Figure 55. 400G PM alarm

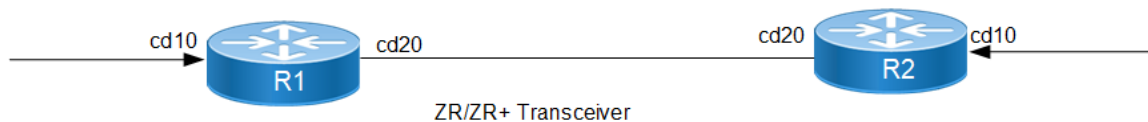

Media-lane Configuration

The below configuration is to set up the threshold value for the media lane.

R1

R1#configure terminal	Enter configure mode.
R1(config)#qsfp-dd 20	Enter QSFP-DD ¹ module configuration.
R1(config-qsfp-dd)#media-lane 1	Enter the Media lane ² configuration
R1(config-qsfp-dd-media)#threshold rx-fdd	Enter the BER threshold for FDD ³ under Threshold configuration
R1(config-qsfp-dd-media-thresh)#ha 0.365	Configure the High alarm threshold ⁴
R1(config-qsfp-dd-media-thresh)#la 0.165	Configure the low alarm threshold
R1(config-qsfp-dd-media-thresh)#exit	Exit threshold Configure mode.
R1(config-qsfp-dd-media)#threshold rx-fed	Enter the BER threshold for FED ⁵ under Threshold configuration
R1(config-qsfp-dd-media-thresh)#ha 0.365	Configure the High alarm threshold
R1(config-qsfp-dd-media-thresh)#la 0.165	Configure the low alarm threshold
R1(config-qsfp-dd-media-thresh)#exit	Exit threshold Configure mode.
R1(config-qsfp-dd-media)#threshold rx-signal-power	Enter the threshold for Rx Signal Power under

¹QSFP-DD stands for Quad Small Form Factor Pluggable Double Density. QSFP-DD modules provide a scalable, high-bandwidth solution for data center networking, enabling efficient data transmission and network performance in modern computing environments.

²Media lanes are the electrical wire pairs (copper cables) or optical fibers that carry signals from the module to the other router and vice-versa.

³FEC Detected Degrade suggests that the FEC has detected errors in data transmission. The alarm notification is triggered if the average BER exceeds the configured FDD value.

⁴This is the highest parameter value for the 400G transceiver to operate safely. When a given parameter value crosses this threshold, the transceiver operation is unreliable, or the transceiver hardware could get damaged.

⁵FEC Excessive Degrade suggests that the FEC has detected very high errors in data transmission. FED is a more severe error condition than FDD and needs more attention. The alarm notification is triggered if the average BER exceeds the configured FED value.

R1#configure terminal	Enter configure mode. Threshold configuration
R1 (config-qsfp-dd-media-thresh)#ha 4	Configure the High alarm threshold
R1 (config-qsfp-dd-media-thresh)#la -3	Configure the low alarm threshold
R1 (config-qsfp-dd-media-thresh)#hw 5	Configure the High warning threshold ¹
R1 (config-qsfp-dd-media-thresh)#lw -5	Configure the low warning threshold
R1 (config-qsfp-dd-media-thresh)#exit	Exit threshold Configure mode.
R1 (config-qsfp-dd-media)#threshold rx-total-power	Enter the threshold for Rx Total Power under Threshold configuration
R1 (config-qsfp-dd-media-thresh)#ha 2	Configure the High alarm threshold
R1 (config-qsfp-dd-media-thresh)#la -2	Configure the low alarm threshold
R1 (config-qsfp-dd-media-thresh)#hw 3	Configure the High warning threshold
R1 (config-qsfp-dd-media-thresh)#lw -3	Configure the low warning threshold
R1 (config-qsfp-dd-media-thresh)#exit	Exit threshold Configure mode.
R1 (config-qsfp-dd-media)#exit	Exit media Configure mode.
R1 (config-qsfp-dd)#commit	Commit the candidate configuration to the running configuration

Host-lane Configuration

The below configuration is to set up the threshold value for the host lane.

R1

R1#configure terminal	Enter Configure mode
R1 (config)#qsfp-dd 10	Enter QSFP-DD ² module configuration
R1 (config-qsfp-dd)#Host-lane 1	Enter the Media lane ³ configuration
R1 (config-qsfp-dd-host)#threshold tx-fdd	Enter the BER threshold for FDD ⁴ under Threshold configuration
R1 (config-qsfp-dd-host-thresh)#ha 0.365	Configure the High alarm threshold ⁵
R1 (config-qsfp-dd-host-thresh)#la 0.165	Configure the low alarm threshold
R1 (config-qsfp-dd-host-thresh)#exit	Exit threshold Configure mode.

¹This is the highest parameter value that limits the optimal operation zone. The transceiver can operate after a parameter crosses this threshold, but performance and operational issues can occur.

²QSFP-DD stands for Quad Small Form Factor Pluggable Double Density. QSFP-DD modules provide a scalable, high-bandwidth solution for data center networking, enabling efficient data transmission and network performance in modern computing environments.

³Media lanes are the electrical wire pairs (copper cables) or optical fibers that carry signals from the module to the other router and vice-versa.

⁴FEC Detected Degrade suggests that the FEC has detected errors in data transmission. The alarm notification is triggered if the average BER exceeds the configured FDD value.

⁵This is the highest parameter value for the 400G transceiver to operate safely. When a given parameter value crosses this threshold, the transceiver operation is unreliable, or the transceiver hardware could get damaged.

R1#configure terminal	Enter Configure mode
R1(config-qsfp-dd-host)#threshold tx-fed	Enter the BER threshold for FED ¹ under Threshold configuration
R1(config-qsfp-dd-host-thresh)#ha 0.765	Configure the High alarm threshold
R1(config-qsfp-dd-host-thresh)#la 0.665	Configure the Low alarm threshold ²
R1(config-qsfp-dd-host-thresh)#exit	Exit threshold Configure mode.
R1(config-qsfp-dd-media)#exit	Exit media Configure mode.
R1(config-qsfp-dd)#commit	Commit the candidate configuration to the running configuration

Validation

R1

The below is the show output of media lane threshold parameter:

```
qsfp-dd 20
media-lane 1
  threshold rx-fdd
    ha 0.365500
    la 0.165000
  threshold rx-fed
    ha 0.365000
    la 0.165000
  threshold rx-total-power
    ha 2.000000
    la -2.000000
    hw 3.000000
    lw -3.000000
  threshold rx-signal-power
    ha 4.000000
    la -3.000000
    hw 5.000000
    lw -5.000000
!
!
end
```

Verify the user-threshold media-lane:

```
#show qsfp-dd 20 user-threshold status media
Codes: [HA : High Alarm], [LA : Low Alarm], [HW : High Warning], [LW : Low Warning]
Port Number          : 20
-----
```

Threshold	Lane	User Config	H/W Config	Minimum	Maximum	Unit
Rx FDD Active	1	3.65e-01	3.65e-01	0.00e+00	1.00e+00	NA
Rx FDD Clear	1	1.65e-01	1.65e-01	0.00e+00	1.00e+00	NA
Rx FED Active	1	3.65e-01	3.65e-01	0.00e+00	1.00e+00	NA
Rx FED Clear	1	1.65e-01	1.65e-01	0.00e+00	1.00e+00	NA
Rx Total Power HA	1	2.00	2.00	0.00	15.00	dBm
Rx Total Power HW	1	3.00	3.00	-10.00	13.00	dBm
Rx Total Power LW	1	-3.00	-	-33.00	-10.00	dBm
Rx Total Power LA	1	-2.00	-	-40.00	-15.00	dBm

¹FEC Excessive Degrad suggests that the FEC has detected very high errors in data transmission. FED is a more severe error condition than FDD and needs more attention. The alarm notification is triggered if the average BER exceeds the configured FED value.

²This is the lowest parameter value for the 400G transceiver to operate safely. When a given parameter value crosses this threshold, the transceiver operation is unreliable.

Rx Signal Power HA	1	4.00	4.00	0.00	15.00	dBm	
Rx Signal Power HW	1	5.00	5.00	-10.00	13.00	dBm	
Rx Signal Power LW	1	-5.00	-	-33.00	-10.00	dBm	
Rx Signal Power LA	1	-3.00	-	-40.00	-15.00	dBm	

The below is the show output of host lane threshold parameter:

```

qsfp-dd 10
 host-lane 1
  threshold tx-fdd
    ha 0.365000
    la 0.165000
  threshold tx-fed
    ha 0.765000
    la 0.665000
    
```

Verify the user-threshold host-lane:

```

#show qsfp-dd 10 user-threshold status host
Port Number          : 20
-----
Threshold | Lane | User Config | H/W Config | Minimum | Maximum | Unit |
-----
Tx FDD Active | 1 | 3.65e-01 | 3.65e-01 | 0.00e+00 | 1.00e+00 | NA |
Tx FDD Clear | 1 | 1.65e-01 | 1.65e-01 | 0.00e+00 | 1.00e+00 | NA |
Tx FED Active | 1 | 7.65e-01 | 7.65e-01 | 0.00e+00 | 1.00e+00 | NA |
Tx FED Clear | 1 | 6.65e-01 | 6.65e-01 | 0.00e+00 | 1.00e+00 | NA |
    
```

Global Threshold Configuration

The below configuration is to set up the threshold value for the global threshold.

R1

R1#configure terminal	Enter Configure mode
R1(config)#qsfp-dd 20	Enter QSFP-DD ¹ module configuration
R1(config-qsfp-dd)#threshold rx-fdd	Enter the media Rx BER threshold for FDD ² under Threshold Configuration
R1(config-qsfp-dd-thresh)#ha 0.963	conc Configure the High alarm threshold ³
R1(config-qsfp-dd-thresh)#la 0.763	conc Configure the Low alarm threshold ⁴
R1(config-qsfp-dd-thresh)#exit	Exit threshold Configure mode.
R1(config-qsfp-dd)#threshold rx-fed	Enter the media Rx BER threshold for FED ⁵ under Threshold Configuration

¹QSFP-DD stands for Quad Small Form Factor Pluggable Double Density. QSFP-DD modules provide a scalable, high-bandwidth solution for data center networking, enabling efficient data transmission and network performance in modern computing environments.

²FEC Detected Degrade suggests that the FEC has detected errors in data transmission. The alarm notification is triggered if the average BER exceeds the configured FDD value.

³This is the highest parameter value for the 400G transceiver to operate safely. When a given parameter value crosses this threshold, the transceiver operation is unreliable, or the transceiver hardware could get damaged.

⁴This is the lowest parameter value for the 400G transceiver to operate safely. When a given parameter value crosses this threshold, the transceiver operation is unreliable.

⁵FEC Excessive Degrade suggests that the FEC has detected very high errors in data transmission. FED is a more severe error condition than FDD and needs more attention. The alarm notification is triggered if the average BER exceeds the configured FED value.

R1#configure terminal	Enter Configure mode
R1 (config-qsfp-dd-thresh) #ha 0.863	conc Configure the High alarm threshold
R1 (config-qsfp-dd-thresh) #la 0.463	conc Configure the Low alarm threshold
R1 (config-qsfp-dd-thresh) #exit	Exit threshold Configure mode.
R1 (config-qsfp-dd) #threshold rx-signal-power	Enter the media threshold for Rx Signal Power under Threshold Configuration
R1 (config-qsfp-dd-thresh) #ha 6	conc Configure the High alarm threshold
R1 (config-qsfp-dd-thresh) #la -6	conc Configure the Low alarm threshold
R1 (config-qsfp-dd-thresh) #hw 4	conc Configure the High warning threshold ¹
R1 (config-qsfp-dd-thresh) #lw -4	conc Configure the Low warning threshold ²
R1 (config-qsfp-dd-thresh) #exit	Exit threshold Configure mode. Exit threshold Configure mode.
R1 (config-qsfp-dd) #threshold rx-total-power	Enter the media threshold for Rx Signal Power under Th Enter the media threshold for Rx Total Power under Threshold Configuration
R1 (config-qsfp-dd-thresh) #ha 7	conc Configure the High alarm threshold
R1 (config-qsfp-dd-thresh) #la -7	conc Configure the Low alarm threshold
R1 (config-qsfp-dd-thresh) #hw 9	conc Configure the High warning threshold
R1 (config-qsfp-dd-thresh) #lw -9	conc Configure the Low warning threshold
R1 (config-qsfp-dd-thresh) #exit	Exit threshold Configure mode. Exit threshold Configure mode.
R1 (config) #qsfp-dd 10	Enter QSFP DD module configuration.
R1 (config-qsfp-dd) #threshold tx-fdd	Enter the host Rx BER threshold for FDD under Threshold Configuration
R1 (config-qsfp-dd-thresh) #ha 0.456	conc Configure the High alarm threshold
R1 (config-qsfp-dd-thresh) #la 0.321	conc Configure the Low alarm threshold
R1 (config-qsfp-dd-thresh) #exit	Exit threshold Configure mode.
R1 (config-qsfp-dd) #threshold tx-fed	Enter the host Rx BER threshold for FED under Threshold Configuration
R1 (config-qsfp-dd-thresh) #ha 0.864	conc Configure the High alarm threshold
R1 (config-qsfp-dd-thresh) #la 0.666	conc Configure the Low alarm threshold
R1 (config-qsfp-dd-thresh) #exit	Exit threshold Configure mode.

R1

The below is the show output of global threshold parameter:

¹This is the highest parameter value that limits the optimal operation zone. The transceiver can operate after a parameter crosses this threshold, but performance and operational issues can occur.

²This is the lowest parameter value that limits the optimal operation zone. The transceiver can operate after a parameter crosses this threshold, but performance and operational issues can occur.

```
#show running-config
qsfp-dd 20
  threshold rx-fdd
    ha 0.963000
    la 0.763000
  threshold rx-fed
    ha 0.863000
    la 0.463000
  threshold rx-total-power
    ha 7.000000
    la -7.000000
    hw 9.000000
    lw -9.000000
  threshold rx-signal-power
    ha 6.000000
    la -6.000000
    hw 4.000000
    lw -4.000000
qspf-dd 10
  threshold tx-fdd
    ha 0.456000
    la 0.321000
  threshold tx-fed
    ha 0.864000
    la 0.666000
```

Verify the global threshold:

```
#show qsfp-dd 20 user-threshold status media
Codes: [HA : High Alarm], [LA : Low Alarm], [HW : High Warning], [LW : Low Warning]
Port Number : 20
```

Threshold	Lane	User Config	H/W Config	Minimum	Maximum	Unit
Rx FDD Active	1	9.63e-01	9.63e-01	0.00e+00	1.00e+00	NA
Rx FDD Clear	1	7.63e-01	7.63e-01	0.00e+00	1.00e+00	NA
Rx FED Active	1	8.63e-01	8.63e-01	0.00e+00	1.00e+00	NA
Rx FED Clear	1	4.63e-01	4.63e-01	0.00e+00	1.00e+00	NA
Rx Total Power HA	1	7.00	7.00	0.00	15.00	dBm
Rx Total Power HW	1	9.00	9.00	-10.00	13.00	dBm
Rx Total Power LW	1	-9.00	-	-33.00	-10.00	dBm
Rx Total Power LA	1	-7.00	-	-40.00	-15.00	dBm
Rx Signal Power HA	1	6.00	6.00	0.00	15.00	dBm
Rx Signal Power HW	1	4.00	4.00	-10.00	13.00	dBm
Rx Signal Power LW	1	-4.00	-	-33.00	-10.00	dBm
Rx Signal Power LA	1	-6.00	-	-40.00	-15.00	dBm

```
#show qspf-dd 10 user-threshold status host
Port Number : 10
```

Threshold	Lane	User Config	H/W Config	Minimum	Maximum	Unit
Tx FDD Active	1	4.56e-01	4.56e-01	0.00e+00	1.00e+00	NA
Tx FDD Clear	1	3.21e-01	3.21e-01	0.00e+00	1.00e+00	NA
Tx FED Active	1	8.64e-01	8.64e-01	0.00e+00	1.00e+00	NA
Tx FED Clear	1	6.66e-01	6.66e-01	0.00e+00	1.00e+00	NA

New CLI Commands

ha	987
hw	988
la	989
lw	990

show qsfdd user-threshold status	991
threshold (host-lane mode)	993
threshold (media-lane mode)	994
threshold (QSFP-DD mode)	996

ha

Use this command to set the high alarm threshold value for the Tx **FDD**¹, Tx **FED**², Rx FDD, Rx FED, Tx power, Rx Total Power, and Rx Signal Power performance monitoring parameters. **High alarm threshold**³ is the highest parameter value for the 400G transceiver to operate safely and reliably. For **FEC**⁴ Detected Degrade (FDD) and FEC Excessive Degrade (FED) monitoring, this command sets the active threshold. FDD suggests that the FEC has detected errors in data transmission. The alarm notification is triggered if the average BER exceeds the configured FDD value.

Command Syntax

```
ha VALUE
no ha
```

Parameters

VALUE

high alarm value

Command Mode

Global threshold mode, host-lane threshold mode, and media-lane threshold mode.

Applicability

This command was introduced in OcNOS version 6.4.1.

Example

The below configuration shows to configure the high warning threshold:

```
OcNOS#configure terminal
OcNOS(config)#qsfp-dd 48
OcNOS(config-qsfp-dd)#threshold tx-fdd
OcNOS(config-qsfp-dd-thresh)#ha 0.9876
OcNOS(config-qsfp-dd-thresh)#commit
OcNOS(config-qsfp-dd-thresh)#no ha
OcNOS(config-qsfp-dd-thresh)#commit
```

¹FEC Detected Degrade suggests that the FEC has detected errors in data transmission. The alarm notification is triggered if the average BER exceeds the configured FDD value.

²FEC Excessive Degrade suggests that the FEC has detected very high errors in data transmission. FED is a more severe error condition than FDD and needs more attention. The alarm notification is triggered if the average BER exceeds the configured FED value.

³This is the highest parameter value for the 400G transceiver to operate safely. When a given parameter value crosses this threshold, the transceiver operation is unreliable, or the transceiver hardware could get damaged.

⁴FEC is a technique that detects and corrects errors during data transmission to maintain the reliability of the communication system.

hw

Use this command to set the high warning threshold value for Tx power, Rx Total Power, and Rx Signal Power.

High warning threshold¹ is the highest parameter value for the 400G transceiver, exceeding which the transceiver performance and operational issues can occur.



Note: This command has no effect for **FED²** and **FDD³** thresholds.

Command Syntax

```
hw VALUE
no hw
```

Parameters

VALUE

high warning value

Command Mode

Global threshold mode, host-lane threshold mode, and media-lane threshold mode.

Applicability

This command was introduced in OcNOS version 6.4.1.

Example

The below configuration shows to configure the high warning threshold:

```
OcNOS#configure terminal
OcNOS(config)#qsfp-dd 48
OcNOS(config-qsfp-dd)#threshold rx-total-power
OcNOS(config-qsfp-dd-thresh)#threshold rx-total-power
OcNOS(config-qsfp-dd-thresh)#hw 3.0
OcNOS(config-qsfp-dd-thresh)#commit
OcNOS(config-qsfp-dd-thresh)#no hw
OcNOS(config-qsfp-dd-thresh)#commit
```

¹This is the highest parameter value that limits the optimal operation zone. The transceiver can operate after a parameter crosses this threshold, but performance and operational issues can occur.

²FEC Excessive Degrade suggests that the FEC has detected very high errors in data transmission. FED is a more severe error condition than FDD and needs more attention. The alarm notification is triggered if the average BER exceeds the configured FED value.

³FEC Detected Degrade suggests that the FEC has detected errors in data transmission. The alarm notification is triggered if the average BER exceeds the configured FDD value.

la

Use this command to set the low alarm threshold value based on the vendor-specific threshold for all the performance monitoring parameters Tx **FDD**¹, Tx **FED**², Rx FDD, Rx FED, Tx power, Rx Total Power, and Rx Signal Power threshold value. **Low alarm threshold**³ is the lowest parameter value for the 400G transceiver to operate with reliability. For FDD and FED monitoring this command sets the clear threshold.

Command Syntax

```
la VALUE
no ha
```

Parameters

VALUE

low alarm value

Command Mode

Global threshold mode, host-lane threshold mode, and media-lane threshold mode.

Applicability

This command was introduced in OcNOS version 6.4.1.

Example

The below configuration shows to configure the low alarm threshold:

```
OcNOS#configure terminal
OcNOS(config)#qsfp-dd 48
OcNOS(config-qsfp-dd)#threshold rx-fed
OcNOS(config-qsfp-dd-thresh)#la 0.001234
OcNOS(config-qsfp-dd-thresh)#commit
OcNOS(config-qsfp-dd-thresh)#no la
OcNOS(config-qsfp-dd-thresh)#commit
```

¹FEC Detected Degrade suggests that the FEC has detected errors in data transmission. The alarm notification is triggered if the average BER exceeds the configured FDD value.

²FEC Excessive Degrade suggests that the FEC has detected very high errors in data transmission. FED is a more severe error condition than FDD and needs more attention. The alarm notification is triggered if the average BER exceeds the configured FED value.

³This is the lowest parameter value for the 400G transceiver to operate safely. When a given parameter value crosses this threshold, the transceiver operation is unreliable.

lw

Use this command to set the low warning threshold value. **Low warning threshold**¹ is the lowest parameter value for the 400G transceiver, below which the transceiver performance and operational issues can occur.



Note: This command has no effect for **FED**² and **FDD**³ thresholds.

Command Syntax

```
lw VALUE
no lw
```

Parameters

lw
low warning value

Command Mode

Global threshold mode, host-lane threshold mode, and media-lane threshold mode.

Applicability

This command was introduced in OcNOS version 6.4.1.

Example

The below configuration shows to configure the low warning threshold:

```
OcNOS#configure terminal
OcNOS (config)#qsfp-dd 48
OcNOS (config-qsfp-dd)#threshold rx-total-power
OcNOS (config-qsfp-dd-thresh)#lw -1.0
OcNOS (config-qsfp-dd-thresh)#commit
OcNOS (config-qsfp-dd-thresh)#no lw
OcNOS (config-qsfp-dd-thresh)#commit
```

¹This is the lowest parameter value that limits the optimal operation zone. The transceiver can operate after a parameter crosses this threshold, but performance and operational issues can occur.

²FEC Excessive Degrade suggests that the FEC has detected very high errors in data transmission. FED is a more severe error condition than FDD and needs more attention. The alarm notification is triggered if the average BER exceeds the configured FED value.

³FEC Detected Degrade suggests that the FEC has detected errors in data transmission. The alarm notification is triggered if the average BER exceeds the configured FDD value.

show qsfdd user-threshold status

Use this command to show the current configuration status of user thresholds.

Command Syntax

```
show qsfdd <PORT> user-threshold status (host|media)
```

Parameters

PORT

The front panel port number of the device where the transceiver is connected

host

Host side config status

media

Media side config status

Command Mode

Execution mode and Privileged execution mode mode.

Applicability

This command was introduced in OcNOS version 6.4.1.

Example

This below show command displays the hardware state of the programmed user thresholds.
OcNOS#show qsfdd 48 user-threshold status host

```
Port Number                : 48
```

Threshold	Lane	User Config	H/W Config	Minimum	Maximum
Tx FDD Active	1	9.88e-01	9.87e-01	0.00e+00	1.00e+00
Tx FDD Clear	1	5.43e-03	5.43e-03	0.00e+00	1.00e+00
Tx FED Active	1	5.43e-01	5.43e-01	0.00e+00	1.00e+00
Tx FED Clear	1	9.88e-03	9.87e-03	0.00e+00	1.00e+00

```
OcNOS#show qsfdd 48 user-threshold status media
```

```
Codes: [HA : High Alarm], [LA : Low Alarm], [HW : High Warning], [LW : Low Warning]
```

```
Port Number                : 48
```

Threshold	Lane	User Config	H/W Config	Minimum	Maximum
Rx FDD Active	1	1.23e-01	1.23e-01	0.00e+00	1.00e+00
Rx FDD Clear	1	6.79e-03	6.78e-03	0.00e+00	1.00e+00
Rx FED Active	1	6.79e-01	6.78e-01	0.00e+00	1.00e+00
Rx FED Clear	1	1.23e-03	1.23e-03	0.00e+00	1.00e+00
Rx Total Power HA	1	4.00	4.00	-26.00	9.00
Rx Total Power HW	1	3.00	3.00	-26.00	9.00
Rx Total Power LW	1	-3.00	-3.00	-26.00	9.00
Rx Total Power LA	1	-4.00	-4.00	-26.00	9.00
Rx Signal Power HA	1	2.00	2.00	-26.00	9.00
Rx Signal Power HW	1	1.00	1.00	-26.00	9.00
Rx Signal Power LW	1	-1.00	-1.00	-26.00	9.00
Rx Signal Power LA	1	-2.00	-2.00	-26.00	9.00

Table 71. show qsfp-dd 48 user-threshold status host output details

Field	Description
Threshold	The parameters that are monitored.
Lane	Displays the channel number where the thresholds are applied.
User Config	Displays what the user has configured.
H/W Config	Displays what is programmed in the transceiver hardware.
Minimum	The lowest values that are allowed to be used for this configuration.
Maximum	The highest values that are allowed to be used for this configuration.

threshold (host-lane mode)

Use this command to enter host lane level user threshold configuration mode. **Host lane**¹ mode is a configuration mode that allows configuring specific values for the host lanes. Host lanes are wires that carry the electrical signal from the host interface to the module and vice-versa.

Command Syntax

```
threshold (tx-fdd|tx-fed)
```

Parameters

tx-fdd

Tx FDD²

tx-fed

Tx FED³

Command Mode

Host-lane mode⁴

Applicability

This command was introduced in OcNOS version 6.4.1.

Example

The below configuration shows to configure the host-lane threshold:

```
OcNOS#configure terminal
OcNOS(config)#qsfp-dd 48
OcNOS(config-qsfp-dd)#host-lane 1
OcNOS(config-qsfp-dd-host)#threshold tx-fdd
OcNOS(config-qsfp-dd-host-thresh)#ha 0.9876
OcNOS(config-qsfp-dd-host-thresh)#la 0.005432
OcNOS(config-qsfp-dd-host-thresh)#threshold tx-fed
OcNOS(config-qsfp-dd-host-thresh)#ha 0.5432
OcNOS(config-qsfp-dd-host-thresh)#la 0.009876
OcNOS(config-qsfp-dd-host-thresh)#commit
```

¹Host lanes are wires that carry the electrical signal from the host interface to the module and vice-versa.

²FEC Detected Degrade suggests that the FEC has detected errors in data transmission. The alarm notification is triggered if the average BER exceeds the configured FDD value.

³FEC Excessive Degrade suggests that the FEC has detected very high errors in data transmission. FED is a more severe error condition than FDD and needs more attention. The alarm notification is triggered if the average BER exceeds the configured FED value.

⁴Host lane mode is a configuration mode that allows configuring specific values for the host lanes. Contrary to the global mode level that configures the same value across all host lanes.

threshold (media-lane mode)

Use this command to enter media lane level user threshold configuration mode. **Media lane**¹ mode is a configuration mode that allows configuring specific values for each media lane. Media lanes are the electrical wire pairs (copper cables) or optical fibers that carry signals from the module to the other router and vice-versa.

Command Syntax

```
threshold (rx-fdd|rx-fed|rx-total-power|rx-signal-power)
```

Parameters

rx-fdd

Rx FDD²

rx-fed

Rx FED³

rx-total-power

Rx Total Power

rx-signal-power

Rx Signal Power

Command Mode

Media-lane mode⁴

Applicability

This command was introduced in OcNOS version 6.4.1.

Example

The below configuration shows to configure the media-lane threshold:

```
OcNOS#configure terminal
OcNOS(config)#qsfp-dd 48
OcNOS(config-qsfp-dd)#media-lane 1
OcNOS(config-qsfp-dd-media)#threshold rx-fdd
OcNOS(config-qsfp-dd-media-thresh)#ha 0.1234
OcNOS(config-qsfp-dd-media-thresh)#la 0.006789
OcNOS(config-qsfp-dd-media-thresh)#threshold rx-fed
OcNOS(config-qsfp-dd-media-thresh)#ha 0.6789
OcNOS(config-qsfp-dd-media-thresh)#la 0.001234
OcNOS(config-qsfp-dd-media-thresh)#threshold rx-total-power
OcNOS(config-qsfp-dd-media-thresh)#ha 4
OcNOS(config-qsfp-dd-media-thresh)#hw 3
OcNOS(config-qsfp-dd-media-thresh)#lw -3
OcNOS(config-qsfp-dd-media-thresh)#la -4
OcNOS(config-qsfp-dd-media-thresh)#threshold rx-signal-power
```

¹Media lanes are the electrical wire pairs (copper cables) or optical fibers that carry signals from the module to the other router and vice-versa.

²FEC Detected Degrade suggests that the FEC has detected errors in data transmission. The alarm notification is triggered if the average BER exceeds the configured FDD value.

³FEC Excessive Degrade suggests that the FEC has detected very high errors in data transmission. FED is a more severe error condition than FDD and needs more attention. The alarm notification is triggered if the average BER exceeds the configured FED value.

⁴Media lane mode is a configuration mode that allows configuring specific values for each media lane (per fiber cable physical channel). Contrary to the global mode level that configures the same value across all media lanes.

```
OcNOS (config-qsfp-dd-media-thresh)#ha 2
OcNOS (config-qsfp-dd-media-thresh)#hw 1
OcNOS (config-qsfp-dd-media-thresh)#lw -1
OcNOS (config-qsfp-dd-media-thresh)#la -2
OcNOS (config-qsfp-dd-media-thresh)#commit
```

threshold (QSFP-DD mode)

Use this command to enter global level user threshold configuration mode. In global mode, configure the same threshold value across all host or media lanes.

Command Syntax

```
threshold (tx-fdd|tx-fed|rx-fdd|rx-fed|rx-total-power|rx-signal-power)
```

Parameters

tx-fdd

Tx FDD¹

tx-fed

Tx FED²

rx-fdd

Rx FDD

rx-fed

Rx FED

rx-total-power

Rx Total Power

rx-signal-power

Rx Signal Power

Command Mode

QSFP-DD³ mode

Applicability

This command was introduced in OcNOS version 6.4.1.

Example

The below configuration shows to configure the threshold in global mode:

```
OcNOS#configure terminal
OcNOS (config)#qsfp-dd 48
OcNOS (config-qsfp-dd)#threshold tx-fdd
OcNOS (config-qsfp-dd-thresh)#ha 0.9876
OcNOS (config-qsfp-dd-thresh)#la 0.005432
OcNOS (config-qsfp-dd-thresh)#threshold tx-fed
OcNOS (config-qsfp-dd-thresh)#ha 0.5432
OcNOS (config-qsfp-dd-thresh)#la 0.009876
OcNOS (config-qsfp-dd-thresh)#threshold rx-fdd
OcNOS (config-qsfp-dd-thresh)#ha 0.1234
OcNOS (config-qsfp-dd-thresh)#la 0.006789
OcNOS (config-qsfp-dd-thresh)#threshold rx-fed
```

¹FEC Detected Degrade suggests that the FEC has detected errors in data transmission. The alarm notification is triggered if the average BER exceeds the configured FDD value.

²FEC Excessive Degrade suggests that the FEC has detected very high errors in data transmission. FED is a more severe error condition than FDD and needs more attention. The alarm notification is triggered if the average BER exceeds the configured FED value.

³QSFP-DD stands for Quad Small Form Factor Pluggable Double Density. QSFP-DD modules provide a scalable, high-bandwidth solution for data center networking, enabling efficient data transmission and network performance in modern computing environments.

```
OcNOS (config-qsfp-dd-thresh)#ha 0.6789
OcNOS (config-qsfp-dd-thresh)#la 0.001234
OcNOS (config-qsfp-dd-thresh)#threshold rx-total-power
OcNOS (config-qsfp-dd-thresh)#ha 4
OcNOS (config-qsfp-dd-thresh)#hw 3
OcNOS (config-qsfp-dd-thresh)#lw -3
OcNOS (config-qsfp-dd-thresh)#la -4
OcNOS (config-qsfp-dd-thresh)#threshold rx-signal-power
OcNOS (config-qsfp-dd-thresh)#ha 2
OcNOS (config-qsfp-dd-thresh)#hw 1
OcNOS (config-qsfp-dd-thresh)#lw -1
OcNOS (config-qsfp-dd-thresh)#la -2
OcNOS (config-qsfp-dd-thresh)#commit
```

Abbreviations

The following are some key abbreviations and their meanings relevant to this document:

Acronym	Description
BER	Bit Error Rate
FDD ¹	FEC ² detected degrade
FEC	Forward error correction
PM	Performance Monitoring
FED ³	FEC excessive degrade
Rx	Receiver
Tx	Transmitter
SNMP	Simple Network Management Protocol

¹FEC Detected Degrade suggests that the FEC has detected errors in data transmission. The alarm notification is triggered if the average BER exceeds the configured FDD value.

²FEC is a technique that detects and corrects errors during data transmission to maintain the reliability of the communication system.

³FEC Excessive Degrade suggests that the FEC has detected very high errors in data transmission. FED is a more severe error condition than FDD and needs more attention. The alarm notification is triggered if the average BER exceeds the configured FED value.

QSFP-DD COMMAND REFERENCE

QSFP-DD Commands	1001
application	1003
ha	1007
hw	1008
la	1009
laser channel	1010
laser grid	1011
laser fine-tune-freq	1013
laser output-power	1014
loopback	1015
lw	1016
prbs	1017
qsfp-dd	1019
rx-output eq-pre-cursor-target	1020
rx-output eq-post-cursor-target	1021
rx-output amp-target	1022
rx cdr-bypass	1023
show qsfp-dd advertisement applications	1024
show qsfp-dd advertisement controls	1029
show qsfp-dd advertisement diagnostics host	1030
show qsfp-dd advertisement diagnostics media	1031
show qsfp-dd advertisement diagnostics module	1032
show qsfp-dd advertisement durations	1033
show qsfp-dd advertisement laser	1034
show qsfp-dd advertisement monitors host	1035
show qsfp-dd advertisement monitors media	1036
show qsfp-dd advertisement monitors module	1038
show qsfp-dd advertisement pages	1039
show qsfp-dd advertisement si	1040
show qsfp-dd si status	1042
show qsfp-dd application	1044
show qsfp-dd diagnostics host	1045
show qsfp-dd diagnostics media	1047
show qsfp-dd eeprom	1048
show qsfp-dd laser grid	1049
show qsfp-dd laser status	1051
show qsfp-dd monitors host	1052

show qsfp-dd monitors media	1054
show qsfp-dd monitors module	1056
show qsfp-dd state	1057
show qsfp-dd user-threshold status	1058
tx-input eq-target	1060
tx cdr-bypass	1061
threshold (host-lane mode)	1062
threshold (media-lane mode)	1063
threshold (QSFP-DD mode)	1065

QSFP-DD Commands

This chapter is a reference for the **QSFP-DD**¹ configuration and status commands:

application	1003
ha	1007
hw	1008
la	1009
laser channel	1010
laser grid	1011
laser fine-tune-freq	1013
laser output-power	1014
loopback	1015
lw	1016
prbs	1017
qsfp-dd	1019
rx-output eq-pre-cursor-target	1020
rx-output eq-post-cursor-target	1021
rx-output amp-target	1022
rx cdr-bypass	1023
show qsfp-dd advertisement applications	1024
show qsfp-dd advertisement controls	1029
show qsfp-dd advertisement diagnostics host	1030
show qsfp-dd advertisement diagnostics media	1031
show qsfp-dd advertisement diagnostics module	1032
show qsfp-dd advertisement durations	1033
show qsfp-dd advertisement laser	1034
show qsfp-dd advertisement monitors host	1035
show qsfp-dd advertisement monitors media	1036
show qsfp-dd advertisement monitors module	1038
show qsfp-dd advertisement pages	1039
show qsfp-dd advertisement si	1040
show qsfp-dd si status	1042
show qsfp-dd application	1044
show qsfp-dd diagnostics host	1045
show qsfp-dd diagnostics media	1047
show qsfp-dd eeprom	1048

¹QSFP-DD stands for Quad Small Form Factor Pluggable Double Density. QSFP-DD modules provide a scalable, high-bandwidth solution for data center networking, enabling efficient data transmission and network performance in modern computing environments.

show qsfp-dd laser grid	1049
show qsfp-dd laser status	1051
show qsfp-dd monitors host	1052
show qsfp-dd monitors media	1054
show qsfp-dd monitors module	1056
show qsfp-dd state	1057
show qsfp-dd user-threshold status	1058
tx-input eq-target	1060
tx cdr-bypass	1061
threshold (host-lane mode)	1062
threshold (media-lane mode)	1063
threshold (QSFP-DD mode)	1065

application

Use this command to select the application ID to be configured for this **QSFP-DD¹** module.

Use the **no** parameter with this command to remove this configuration. If no application is configured then application ID 1 will be selected as per module default.



Notes: Only 400G application modes are supported.

For checking the supported applications modes **show qsfp-dd <port no.> advertisement applications** command, see the example.

Example

```
OcNOS#show qsfp-dd 49 application

Port Number                : 49
-----
User Config | H/W Config
-----
Application 2 | Application 2

OcNOS#sh qsfp-dd 49 advertisement applications

Port Number                : 49
> Application 1:
  | Host |
    Interface                : 400GAUI-8 C2M
    Application BR            : 425.00
    Lane Count                : 8
    Lane Sig BR               : 26.5625
    Modulation Format          : PAM4
    Bits Per Unit Intvl       : 2.000000
    Lane Assigned             : Lane-1
  | Media |
    Interface                : 400ZR, DWDM, Amplified
    Application BR            : 478.75
    Lane Count                : 1
    Lane Sig BR               : 59.84375
    Modulation Format          : DP-16QAM
    Bits Per Unit Intvl       : 8.000000
    Lane Assigned             : Lane-1
Application 2:
  | Host |
    Interface                : 400GAUI-8 C2M
    Application BR            : 425.00
    Lane Count                : 8
    Lane Sig BR               : 26.5625
    Modulation Format          : PAM4
    Bits Per Unit Intvl       : 2.000000
    Lane Assigned             : Lane-1
  | Media |
    Interface                : 400ZR, Single Wavelen., Unamp.
    Application BR            : 478.75
    Lane Count                : 1
    Lane Sig BR               : 59.84375
    Modulation Format          : DP-16QAM
    Bits Per Unit Intvl       : 8.000000
```

¹QSFP-DD stands for Quad Small Form Factor Pluggable Double Density. QSFP-DD modules provide a scalable, high-bandwidth solution for data center networking, enabling efficient data transmission and network performance in modern computing environments.

```

    Lane Assigned      : Lane-1
Application 3:
  | Host |
    Interface         : 100GAUI-2 C2M
    Application BR     : 106.25
    Lane Count         : 2
    Lane Sig BR        : 26.5625
    Modulation Format   : PAM4
    Bits Per Unit Intvl : 2.000000
    Lane Assigned      : Lane-7/Lane-5/Lane-3/Lane-1
  | Media |
    Interface         : 400ZR, DWDM, Amplified
    Application BR     : 478.75
    Lane Count         : 1
    Lane Sig BR        : 59.84375
    Modulation Format   : DP-16QAM
    Bits Per Unit Intvl : 8.000000
    Lane Assigned      : Lane-1
Application 4:
  | Host |
    Interface         : 400GAUI-8 C2M
    Application BR     : 425.00
    Lane Count         : 8
    Lane Sig BR        : 26.5625
    Modulation Format   : PAM4
    Bits Per Unit Intvl : 2.000000
    Lane Assigned      : Lane-1
  | Media |
    Interface         : ZR400-OFEC-16QAM
    Application BR     : 481.108374
    Lane Count         : 1
    Lane Sig BR        : 60.1385468
    Modulation Format   : DP-16QAM
    Bits Per Unit Intvl : 8.000000
    Lane Assigned      : Lane-1
Application 5:
  | Host |
    Interface         : 100GAUI-2 C2M
    Application BR     : 106.25
    Lane Count         : 2
    Lane Sig BR        : 26.5625
    Modulation Format   : PAM4
    Bits Per Unit Intvl : 2.000000
    Lane Assigned      : Lane-7/Lane-5/Lane-3/Lane-1
  | Media |
    Interface         : ZR400-OFEC-16QAM
    Application BR     : 481.108374
    Lane Count         : 1
    Lane Sig BR        : 60.1385468
    Modulation Format   : DP-16QAM
    Bits Per Unit Intvl : 8.000000
    Lane Assigned      : Lane-1
Application 6:
  | Host |
    Interface         : 100GAUI-2 C2M
    Application BR     : 106.25
    Lane Count         : 2
    Lane Sig BR        : 26.5625
    Modulation Format   : PAM4
    Bits Per Unit Intvl : 2.000000
    Lane Assigned      : Lane-7/Lane-5/Lane-3/Lane-1
  | Media |
    Interface         : ZR300-OFEC-8QAM
    Application BR     : 360.831281
    Lane Count         : 1
    Lane Sig BR        : 60.1385468
    Modulation Format   : DP-8QAM
    Bits Per Unit Intvl : 6.000000

```

```

        Lane Assigned      : Lane-1
Application 7:
  | Host |
    Interface      : 100GAUI-2 C2M
    Application BR  : 106.25
    Lane Count     : 2
    Lane Sig BR    : 26.5625
    Modulation Format : PAM4
    Bits Per Unit Intvl : 2.000000
    Lane Assigned  : Lane-7/Lane-5/Lane-3/Lane-1
  | Media |
    Interface      : ZR200-OFEC-QPSK
    Application BR  : 240.554187
    Lane Count     : 1
    Lane Sig BR    : 60.1385468
    Modulation Format : DP-QPSK
    Bits Per Unit Intvl : 4.000000
    Lane Assigned  : Lane-1
Application 8:
  | Host |
    Interface      : 100GAUI-2 C2M
    Application BR  : 106.25
    Lane Count     : 2
    Lane Sig BR    : 26.5625
    Modulation Format : PAM4
    Bits Per Unit Intvl : 2.000000
    Lane Assigned  : Lane-7/Lane-5/Lane-3/Lane-1
  | Media |
    Interface      : ZR100-OFEC-QPSK
    Application BR  : 120.277094
    Lane Count     : 1
    Lane Sig BR    : 30.069273
    Modulation Format : DP-QPSK
    Bits Per Unit Intvl : 4.000000
    Lane Assigned  : Lane-1

```

Command Syntax

```
application <2-15>
```

Parameters

<2-15>

Configurable application IDs

Command Mode

QSFP-DD mode

Default

By default, application ID 1 is selected.

Applicability

This command was introduced before OcNOS version 6.1.0.

Example

```
#configure terminal
```

```
(config)#qsfp-dd 0
(config-qsfp-dd)#application 8
(config-qsfp-dd)#commit
(config-qsfp-dd)#no application
(config-qsfp-dd)#commit
(config-qsfp-dd)#
```

ha

Use this command to set the high alarm threshold value for the Tx **FDD**¹, Tx **FED**², Rx FDD, Rx FED, Tx power, Rx Total Power, and Rx Signal Power performance monitoring parameters. **High alarm threshold**³ is the highest parameter value for the 400G transceiver to operate safely and reliably. For **FEC**⁴ Detected Degrade (FDD) and FEC Excessive Degrade (FED) monitoring, this command sets the active threshold. FDD suggests that the FEC has detected errors in data transmission. The alarm notification is triggered if the average BER exceeds the configured FDD value.

Command Syntax

```
ha VALUE
no ha
```

Parameters

VALUE

high alarm value

Command Mode

Global threshold mode, host-lane threshold mode, and media-lane threshold mode.

Applicability

This command was introduced in OcNOS version 6.4.1.

Example

The below configuration shows to configure the high warning threshold:

```
OcNOS#configure terminal
OcNOS(config)#qsfp-dd 48
OcNOS(config-qsfp-dd)#threshold tx-fdd
OcNOS(config-qsfp-dd-thresh)#ha 0.9876
OcNOS(config-qsfp-dd-thresh)#commit
OcNOS(config-qsfp-dd-thresh)#no ha
OcNOS(config-qsfp-dd-thresh)#commit
```

¹FEC Detected Degrade suggests that the FEC has detected errors in data transmission. The alarm notification is triggered if the average BER exceeds the configured FDD value.

²FEC Excessive Degrade suggests that the FEC has detected very high errors in data transmission. FED is a more severe error condition than FDD and needs more attention. The alarm notification is triggered if the average BER exceeds the configured FED value.

³This is the highest parameter value for the 400G transceiver to operate safely. When a given parameter value crosses this threshold, the transceiver operation is unreliable, or the transceiver hardware could get damaged.

⁴FEC is a technique that detects and corrects errors during data transmission to maintain the reliability of the communication system.

hw

Use this command to set the high warning threshold value for Tx power, Rx Total Power, and Rx Signal Power.

High warning threshold¹ is the highest parameter value for the 400G transceiver, exceeding which the transceiver performance and operational issues can occur.



Note: This command has no effect for **FED**² and **FDD**³ thresholds.

Command Syntax

```
hw VALUE
no hw
```

Parameters

VALUE

high warning value

Command Mode

Global threshold mode, host-lane threshold mode, and media-lane threshold mode.

Applicability

This command was introduced in OcNOS version 6.4.1.

Example

The below configuration shows to configure the high warning threshold:

```
OcNOS#configure terminal
OcNOS (config)#qsfp-dd 48
OcNOS (config-qsfp-dd)#threshold rx-total-power
OcNOS (config-qsfp-dd-thresh)#threshold rx-total-power
OcNOS (config-qsfp-dd-thresh)#hw 3.0
OcNOS (config-qsfp-dd-thresh)#commit
OcNOS (config-qsfp-dd-thresh)#no hw
OcNOS (config-qsfp-dd-thresh)#commit
```

¹This is the highest parameter value that limits the optimal operation zone. The transceiver can operate after a parameter crosses this threshold, but performance and operational issues can occur.

²FEC Excessive Degrade suggests that the FEC has detected very high errors in data transmission. FED is a more severe error condition than FDD and needs more attention. The alarm notification is triggered if the average BER exceeds the configured FED value.

³FEC Detected Degrade suggests that the FEC has detected errors in data transmission. The alarm notification is triggered if the average BER exceeds the configured FDD value.

la

Use this command to set the low alarm threshold value based on the vendor-specific threshold for all the performance monitoring parameters Tx **FDD**¹, Tx **FED**², Rx FDD, Rx FED, Tx power, Rx Total Power, and Rx Signal Power threshold value. **Low alarm threshold**³ is the lowest parameter value for the 400G transceiver to operate with reliability. For FDD and FED monitoring this command sets the clear threshold.

Command Syntax

```
la VALUE
no ha
```

Parameters

VALUE

low alarm value

Command Mode

Global threshold mode, host-lane threshold mode, and media-lane threshold mode.

Applicability

This command was introduced in OcNOS version 6.4.1.

Example

The below configuration shows to configure the low alarm threshold:

```
OcNOS#configure terminal
OcNOS(config)#qsfp-dd 48
OcNOS(config-qsfp-dd)#threshold rx-fed
OcNOS(config-qsfp-dd-thresh)#la 0.001234
OcNOS(config-qsfp-dd-thresh)#commit
OcNOS(config-qsfp-dd-thresh)#no la
OcNOS(config-qsfp-dd-thresh)#commit
```

¹FEC Detected Degrade suggests that the FEC has detected errors in data transmission. The alarm notification is triggered if the average BER exceeds the configured FDD value.

²FEC Excessive Degrade suggests that the FEC has detected very high errors in data transmission. FED is a more severe error condition than FDD and needs more attention. The alarm notification is triggered if the average BER exceeds the configured FED value.

³This is the lowest parameter value for the 400G transceiver to operate safely. When a given parameter value crosses this threshold, the transceiver operation is unreliable.

laser channel

Use this command to configure the laser channel number for the **QSFP-DD**¹ module.

Command Syntax

```
laser channel NUMBER
no laser channel
```

Parameters

NUMBER

channel number

Default

None

Command Mode

QSFP-DD mode

Applicability

This command was introduced in OcNOS version 6.2.0.

Examples

```
#configure terminal
(config)#qsfp-dd 0
(config-qsfp-dd)#laser channel 10
(config-qsfp-dd)#commit
(config-qsfp-dd)#no laser channel
(config-qsfp-dd)#commit
(config-qsfp-dd)#
```

¹QSFP-DD stands for Quad Small Form Factor Pluggable Double Density. QSFP-DD modules provide a scalable, high-bandwidth solution for data center networking, enabling efficient data transmission and network performance in modern computing environments.

laser grid

Use this command to configure the laser grid spacing frequency for the **QSFP-DD**¹ module.

**Note:**

If the module supports the 100 GHz grid, using the "no" command will configure the grid to 100 GHz. If the module does not support 100 GHz, the previous value will remain unchanged.

Command Syntax

```
laser grid (3p125|6p25|12p5|25|33|50|75|100)
no laser grid
```

Parameters

3p125

3.125 GHz

6p25

6.25 GHz

12p5

12.5 GHz

25

25 GHz

33

33 GHz

50

50 GHz

75

75 GHz

100

100 GHz

Default

100 GHz

Command Mode

QSFP-DD mode

Applicability

This command was introduced in OcNOS version 6.2.0.

¹QSFP-DD stands for Quad Small Form Factor Pluggable Double Density. QSFP-DD modules provide a scalable, high-bandwidth solution for data center networking, enabling efficient data transmission and network performance in modern computing environments.

Examples

```
#configure terminal
(config)#qsfp-dd 0
(config-qsfp-dd)#laser grid 50
(config-qsfp-dd)#commit
(config-qsfp-dd)#no laser grid
(config-qsfp-dd)#commit
(config-qsfp-dd)#
```

laser fine-tune-freq

Use this command to configure the laser fine tune frequency offset for the **QSFP-DD**¹ module.

Command Syntax

```
laser fine-tune-freq VALUE
no laser fine-tune-freq
```

Parameters

VALUE

Fine tune frequency offset in GHz

Default

None

Command Mode

QSFP-DD mode

Applicability

This command was introduced in OcNOS version 6.2.0.

Examples

```
#configure terminal
(config)#qsfp-dd 0
(config-qsfp-dd)#laser fine-tune-freq 1.5
(config-qsfp-dd)#commit
(config-qsfp-dd)#no laser fine-tune-freq
(config-qsfp-dd)#commit
(config-qsfp-dd)#
```

¹QSFP-DD stands for Quad Small Form Factor Pluggable Double Density. QSFP-DD modules provide a scalable, high-bandwidth solution for data center networking, enabling efficient data transmission and network performance in modern computing environments.

laser output-power

Use this command to configure the laser target output power for the **QSFP-DD**¹ module.

Command Syntax

```
laser output-power VALUE
no laser output-power
```

Parameters

VALUE

Laser target output power

Default

None

Command Mode

QSFP-DD mode

Applicability

This command was introduced in OcNOS version 6.2.0.

Examples

```
#configure terminal
(config)#qsfp-dd 0
(config-qsfp-dd)#laser output-power -9.2
(config-qsfp-dd)#commit
(config-qsfp-dd)#no laser output-power
(config-qsfp-dd)#commit
(config-qsfp-dd)#
```

¹QSFP-DD stands for Quad Small Form Factor Pluggable Double Density. QSFP-DD modules provide a scalable, high-bandwidth solution for data center networking, enabling efficient data transmission and network performance in modern computing environments.

loopback

Use this command to configure the loopback type (input, output, both) on the **QSFP-DD**¹ module host/media side. If the loopback type is supported by the QSFP-DD module this will enable the loopback function.

Use the **no** parameter to remove this configuration and disable the loopback function.

Command Syntax

```
loopback (in|out|both) (host|media)
no loopback (host|media)
```

Parameters

- in**
Configure input loopback
- out**
Configure output loopback
- both**
Configure input and output loopback
- host**
Configure host side
- media**
Configure media side

Command Mode

QSFP-DD mode

Applicability

This command was introduced before OcNOS version 6.1.0.

Example

```
(config)#qsfp-dd 0
(config-qsfp-dd)#loopback in host
(config-qsfp-dd)#loopback out media
(config-qsfp-dd)#commit
(config-qsfp-dd)#loopback both media
(config-qsfp-dd)#no loopback host
(config-qsfp-dd)#commit
(config-qsfp-dd)#
```

¹QSFP-DD stands for Quad Small Form Factor Pluggable Double Density. QSFP-DD modules provide a scalable, high-bandwidth solution for data center networking, enabling efficient data transmission and network performance in modern computing environments.

lw

Use this command to set the low warning threshold value. **Low warning threshold**¹ is the lowest parameter value for the 400G transceiver, below which the transceiver performance and operational issues can occur.



Note: This command has no effect for **FED**² and **FDD**³ thresholds.

Command Syntax

```
lw VALUE
no lw
```

Parameters

lw

low warning value

Command Mode

Global threshold mode, host-lane threshold mode, and media-lane threshold mode.

Applicability

This command was introduced in OcNOS version 6.4.1.

Example

The below configuration shows to configure the low warning threshold:

```
OcNOS#configure terminal
OcNOS(config)#qsfp-dd 48
OcNOS(config-qsfp-dd)#threshold rx-total-power
OcNOS(config-qsfp-dd-thresh)#lw -1.0
OcNOS(config-qsfp-dd-thresh)#commit
OcNOS(config-qsfp-dd-thresh)#no lw
OcNOS(config-qsfp-dd-thresh)#commit
```

¹This is the lowest parameter value that limits the optimal operation zone. The transceiver can operate after a parameter crosses this threshold, but performance and operational issues can occur.

²FEC Excessive Degrade suggests that the FEC has detected very high errors in data transmission. FED is a more severe error condition than FDD and needs more attention. The alarm notification is triggered if the average BER exceeds the configured FED value.

³FEC Detected Degrade suggests that the FEC has detected errors in data transmission. The alarm notification is triggered if the average BER exceeds the configured FDD value.

prbs

Use these commands to configure the PRBS pattern generator/checker type to be used for diagnostics of the **QSFP-DD**¹ module host/media side and to configure the PRBS pattern generator/checker location (pre-fec/post-fec) on the QSFP-DD module host/media side. If the generator/checker pattern type and location are supported by the QSFP-DD module this will enable the selected function.

Use the **no** parameter to remove this configuration and disable the generator/checker function.

Command Syntax

```
prbs (generator|checker) type (31q|31|23q|23|15q|15|13q|13|9q|9|7q|7|ssprq) (host|media)
prbs (generator|checker) (pre-fec|post-fec) (host|media)
no prbs (generator|checker) type (host|media)
no prbs (generator|checker) (host|media)
```

Parameters

generator

Configure the pattern generator

checker

Configure the pattern checker

31q

Configure PRBS-31Q type

31

Configure PRBS-31 type

23q

Configure PRBS-23Q type

23

Configure PRBS-23 type

15q

Configure PRBS-15Q type

15

Configure PRBS-15 type

13q

Configure PRBS-13Q type

13

Configure PRBS-13 type

9q

Configure PRBS-9Q type

9

Configure PRBS-9 type

7q

Configure PRBS-7q type

¹QSFP-DD stands for Quad Small Form Factor Pluggable Double Density. QSFP-DD modules provide a scalable, high-bandwidth solution for data center networking, enabling efficient data transmission and network performance in modern computing environments.

7

Configure PRBS-7 type

ssprq

Configure SSPRQ type

pre-fec

Configure to generate before the **FEC**¹ encoder / check before the FEC decoder

post-fec

Configure to generate after the FEC encoder / check after the FEC decoder

host

Configure host side

media

Configure media side

Command Mode

QSFP-DD mode

Applicability

This command was introduced before OcNOS version 6.1.0.

Example

```
#configure terminal
(config)#qsfp-dd 0
(config-qsfp-dd)#prbs generator type 15 host
(config-qsfp-dd)#prbs checker type 23q host
(config-qsfp-dd)#prbs generator type 7q media
(config-qsfp-dd)#prbs checker type ssprq media
(config-qsfp-dd)#commit
(config-qsfp-dd)#no prbs generator type host
(config-qsfp-dd)#no prbs checker type media
(config-qsfp-dd)#commit
(config-qsfp-dd)#
```

¹FEC is a technique that detects and corrects errors during data transmission to maintain the reliability of the communication system.

qsfp-dd

Use this command to select a **QSFP-DD**¹ port to configure and enter the `qsfp-dd` command mode. Use the `exit` command to quit from this mode.

Command Syntax

```
qsfp-dd PORTNUM
```

Parameters

PORTNUM

QSFP-DD front panel port number

Command Mode

Configure mode

Applicability

This command was introduced before OcNOS version 6.1.0.

Example

```
#configure terminal
(config)#qsfp-dd 0
(config-qsfp-dd)#
```

¹QSFP-DD stands for Quad Small Form Factor Pluggable Double Density. QSFP-DD modules provide a scalable, high-bandwidth solution for data center networking, enabling efficient data transmission and network performance in modern computing environments.

rx-output eq-pre-cursor-target

Use this command to configure the Rx output equalizer pre-cursor target override value.

Use the no form of this command to remove the Rx output equalizer pre-cursor target override value.

Command Syntax

```
rx-output eq-pre-cursor-target <1-15>
no rx-output eq-pre-cursor-target
```

Parameters

<1-15>

Output equalizer pre-cursor target value

Default

None

Command Mode

QSFP-DD¹ mode and QSFP-DD host-lane mode modes

Applicability

This command was introduced before OcNOS version 6.5.1.

Example

```
#configure terminal
(config)#qsfp-dd 0
(config-qsfp-dd)#rx-output eq-pre-cursor-target 4
(config-qsfp-dd)#commit
(config-qsfp-dd)#no rx-output eq-pre-cursor-target
(config-qsfp-dd)#commit
(config-qsfp-dd)#host-lane 2
(config-qsfp-dd-host)#rx-output eq-pre-cursor-target 1
(config-qsfp-dd-host)#commit
(config-qsfp-dd-host)#no rx-output eq-pre-cursor-target
(config-qsfp-dd-host)#commit
```

¹QSFP-DD stands for Quad Small Form Factor Pluggable Double Density. QSFP-DD modules provide a scalable, high-bandwidth solution for data center networking, enabling efficient data transmission and network performance in modern computing environments.

rx-output eq-post-cursor-target

Use this command to configure the Rx output equalizer post-cursor target override value.

Use the no form of this command to remove the Rx output equalizer post-cursor target override value..

Command Syntax

```
rx-output eq-post-cursor-target <1-15>
no rx-output eq-post-cursor-target
```

Parameters

<1-15>

Output equalizer post-cursor target value

Default

None

Command Mode

QSFP-DD¹ mode and QSFP-DD host-lane mode

Applicability

This command was introduced before OcNOS version 6.5.1.

Example

```
#configure terminal
(config)#qsfp-dd 0
(config-qsfp-dd)#rx-output eq-post-cursor-target 2
(config-qsfp-dd)#commit
(config-qsfp-dd)#no rx-output eq-post-cursor-target
(config-qsfp-dd)#commit
(config-qsfp-dd)#host-lane 7
(config-qsfp-dd-host)#rx-output eq-post-cursor-target 6
(config-qsfp-dd-host)#commit
(config-qsfp-dd-host)#no rx-output eq-post-cursor-target
(config-qsfp-dd-host)#commit
```

¹QSFP-DD stands for Quad Small Form Factor Pluggable Double Density. QSFP-DD modules provide a scalable, high-bandwidth solution for data center networking, enabling efficient data transmission and network performance in modern computing environments.

rx-output amp-target

Use this command to configure the Rx output amplitude target override value.

Use the no form of this command to remove the Rx output amplitude target override value.

Command Syntax

```
rx-output amp-target <0-15>
no rx-output amp-target
```

Parameters

<1-15>

Output amplitude target value

Default

None

Command Mode

QSFP-DD¹ mode and QSFP-DD host-lane mode

Applicability

This command was introduced before OcNOS version 6.5.1.

Example

```
#configure terminal
(config)#qsfp-dd 0
(config-qsfp-dd)#rx-output amp-target 0
(config-qsfp-dd)#commit
(config-qsfp-dd)#no rx-output amp-target
(config-qsfp-dd)#commit
(config-qsfp-dd)#host-lane 3
(config-qsfp-dd-host)#rx-output amp-target 1
(config-qsfp-dd-host)#commit
(config-qsfp-dd-host)#no rx-output amp-target
(config-qsfp-dd-host)#commit
```

¹QSFP-DD stands for Quad Small Form Factor Pluggable Double Density. QSFP-DD modules provide a scalable, high-bandwidth solution for data center networking, enabling efficient data transmission and network performance in modern computing environments.

rx cdr-bypass

Use this command to enable the Rx CDR bypass.

Use the no form of this command to disable the Rx CDR bypass.

Command Syntax

```
rx cdr-bypass
no rx cdr-bypass
```

Parameters

None

Command Mode

QSFP-DD¹ mode and QSFP-DD host-lane mode

Applicability

This command was introduced before OcNOS version 6.5.1.

Example

```
#configure terminal
(config)#qsfp-dd 0
(config-qsfp-dd)#rx cdr-bypass
(config-qsfp-dd)#commit
(config-qsfp-dd)#no rx cdr-bypass
(config-qsfp-dd)#commit
(config-qsfp-dd)#host-lane 2
(config-qsfp-dd-host)#rx cdr-bypass
(config-qsfp-dd-host)#commit
(config-qsfp-dd-host)#no rx cdr-bypass
```

¹QSFP-DD stands for Quad Small Form Factor Pluggable Double Density. QSFP-DD modules provide a scalable, high-bandwidth solution for data center networking, enabling efficient data transmission and network performance in modern computing environments.

show qsfp-dd advertisement applications

Use this command to show **QSFP-DD**¹ module advertised applications.

Command Syntax

```
show qsfp-dd PORTNUM advertisement applications
```

Parameters

PORTNUM

QSFP-DD front panel port number

Command Mode

Execution mode and Privileged execution mode

Applicability

This command was introduced before OcNOS version 6.1.0.

Example

```
show qsfp-dd 0 advertisement applications

Port Number                : 0
> Application 1:
  | Host |
    Interface                : 400GAUI-8 C2M
    Application BR            : 425.00
    Lane Count                : 8
    Lane Sig BR               : 26.5625
    Modulation Format          : PAM4
    Bits Per Unit Intvl       : 2
    Lane Assigned             : Lane-1
  | Media |
    Interface                : 400ZR, DWDM, Amplified
    Application BR            : 478.75
    Lane Count                : 1
    Lane Sig BR               : 59.84375
    Modulation Format          : DP-16QAM
    Bits Per Unit Intvl       : 8
    Lane Assigned             : Lane-1
Application 2:
  | Host |
    Interface                : 400GAUI-8 C2M
    Application BR            : 425.00
    Lane Count                : 8
    Lane Sig BR               : 26.5625
    Modulation Format          : PAM4
    Bits Per Unit Intvl       : 2
    Lane Assigned             : Lane-1
  | Media |
    Interface                : 400ZR, Single Wavelen., Unamp.
    Application BR            : 478.75
```

¹QSFP-DD stands for Quad Small Form Factor Pluggable Double Density. QSFP-DD modules provide a scalable, high-bandwidth solution for data center networking, enabling efficient data transmission and network performance in modern computing environments.

```

    Lane Count          : 1
    Lane Sig BR         : 59.84375
    Modulation Format    : DP-16QAM
    Bits Per Unit Intvl : 8
    Lane Assigned       : Lane-1
Application 3:
  | Host |
    Interface          : 100GAUI-2 C2M
    Application BR     : 106.25
    Lane Count         : 2
    Lane Sig BR        : 26.5625
    Modulation Format   : PAM4
    Bits Per Unit Intvl : 2
    Lane Assigned      : Lane-7/Lane-5/Lane-3/Lane-1
  | Media |
    Interface          : 400ZR, DWDM, Amplified
    Application BR     : 478.75
    Lane Count         : 1
    Lane Sig BR        : 59.84375
    Modulation Format   : DP-16QAM
    Bits Per Unit Intvl : 8
    Lane Assigned      : Lane-1
Application 4:
  | Host |
    Interface          : 400GAUI-8 C2M
    Application BR     : 425.00
    Lane Count         : 8
    Lane Sig BR        : 26.5625
    Modulation Format   : PAM4
    Bits Per Unit Intvl : 2
    Lane Assigned      : Lane-1
  | Media |
    Interface          : 400ZRP, DWDM, amplified 120Km
    Application BR     : 481.108374
    Lane Count         : 1
    Lane Sig BR        : 60.1385468
    Modulation Format   : DP-16QAM
    Bits Per Unit Intvl : 8
    Lane Assigned      : Lane-1
Application 5:
  | Host |
    Interface          : 400GAUI-8 C2M
    Application BR     : 425.00
    Lane Count         : 8
    Lane Sig BR        : 26.5625
    Modulation Format   : PAM4
    Bits Per Unit Intvl : 2
    Lane Assigned      : Lane-1
  | Media |
    Interface          : 400ZRP, DWDM, Amplified 450Km
    Application BR     : 481.108374
    Lane Count         : 1
    Lane Sig BR        : 60.1385468
    Modulation Format   : DP-16QAM
    Bits Per Unit Intvl : 8
    Lane Assigned      : Lane-1
Application 6:
  | Host |
    Interface          : 100GAUI-2 C2M
    Application BR     : 106.25
    Lane Count         : 2
    Lane Sig BR        : 26.5625
    Modulation Format   : PAM4
    Bits Per Unit Intvl : 2
    Lane Assigned      : Lane-7/Lane-5/Lane-3/Lane-1
  | Media |
    Interface          : 400ZRP, DWDM, Amplified 450Km
    Application BR     : 481.108374

```



```

    Lane Count          : 1
    Lane Sig BR         : 60.1385468
    Modulation Format    : DP-16QAM
    Bits Per Unit Intvl : 8
    Lane Assigned       : Lane-1
Application 7:
  | Host |
    Interface          : 100GAUI-2 C2M
    Application BR      : 106.25
    Lane Count         : 2
    Lane Sig BR        : 26.5625
    Modulation Format   : PAM4
    Bits Per Unit Intvl : 2
    Lane Assigned      : Lane-7/Lane-5/Lane-3/Lane-1
  | Media |
    Interface          : 100ZRP, DWDM, Amplified 600Km
    Application BR      : 360.831281
    Lane Count         : 1
    Lane Sig BR        : 60.1385468
    Modulation Format   : DP-8QAM
    Bits Per Unit Intvl : 6
    Lane Assigned      : Lane-1
Application 8:
  | Host |
    Interface          : 400GAUI-8 C2M
    Application BR      : 425.00
    Lane Count         : 8
    Lane Sig BR        : 26.5625
    Modulation Format   : PAM4
    Bits Per Unit Intvl : 2
    Lane Assigned      : Lane-1
  | Media |
    Interface          : 400ZRP, DWDM, amplified 450Km (Enhanced Constellation)
    Application BR      : 481.108374
    Lane Count         : 1
    Lane Sig BR        : 60.1385468
    Modulation Format   : DP-16QAM
    Bits Per Unit Intvl : 8
    Lane Assigned      : Lane-1
Application 9:
  | Host |
    Interface          : 100GAUI-2 C2M
    Application BR      : 106.25
    Lane Count         : 2
    Lane Sig BR        : 26.5625
    Modulation Format   : PAM4
    Bits Per Unit Intvl : 2
    Lane Assigned      : Lane-7/Lane-5/Lane-3/Lane-1
  | Media |
    Interface          : 400ZRP, DWDM, amplified 450Km (Enhanced Constellation)
    Application BR      : 481.108374
    Lane Count         : 1
    Lane Sig BR        : 60.1385468
    Modulation Format   : DP-16QAM
    Bits Per Unit Intvl : 8
    Lane Assigned      : Lane-1
Application 10:
  | Host |
    Interface          : 100GAUI-2 C2M
    Application BR      : 106.25
    Lane Count         : 2
    Lane Sig BR        : 26.5625
    Modulation Format   : PAM4
    Bits Per Unit Intvl : 2
    Lane Assigned      : Lane-7/Lane-5/Lane-3/Lane-1
  | Media |
    Interface          : 100ZRP, DWDM, amplified 600Km (Enhanced Constellation)
    Application BR      : 360.831281

```

```

    Lane Count          : 1
    Lane Sig BR         : 60.1385468
    Modulation Format    : DP-8QAM
    Bits Per Unit Intvl : 6
    Lane Assigned       : Lane-1
Application 11:
  | Host |
    Interface          : 100GAUI-2 C2M
    Application BR     : 106.25
    Lane Count         : 2
    Lane Sig BR        : 26.5625
    Modulation Format   : PAM4
    Bits Per Unit Intvl : 2
    Lane Assigned      : Lane-7/Lane-5/Lane-3/Lane-1
  | Media |
    Interface          : 100ZRP, DWDM, Amplified 1000Km
    Application BR     : 240.554187
    Lane Count         : 1
    Lane Sig BR        : 60.1385468
    Modulation Format   : DP-QPSK
    Bits Per Unit Intvl : 4
    Lane Assigned      : Lane-1
Application 12:
  | Host |
    Interface          : CAUI-4 C2M without FEC
    Application BR     : 103.13
    Lane Count         : 4
    Lane Sig BR        : 25.78125
    Modulation Format   : NRZ
    Bits Per Unit Intvl : 1
    Lane Assigned      : Lane-5/Lane-1
  | Media |
    Interface          : 100ZRP, DWDM, Amplified 1000Km
    Application BR     : 240.554187
    Lane Count         : 1
    Lane Sig BR        : 60.1385468
    Modulation Format   : DP-QPSK
    Bits Per Unit Intvl : 4
    Lane Assigned      : Lane-1
Application 13:
  | Host |
    Interface          : 100GAUI-2 C2M
    Application BR     : 106.25
    Lane Count         : 2
    Lane Sig BR        : 26.5625
    Modulation Format   : PAM4
    Bits Per Unit Intvl : 2
    Lane Assigned      : Lane-7/Lane-5/Lane-3/Lane-1
  | Media |
    Interface          : 100ZRP, DWDM, amplified 2000Km
    Application BR     : 120.277094
    Lane Count         : 1
    Lane Sig BR        : 30.069273
    Modulation Format   : DP-QPSK
    Bits Per Unit Intvl : 4
    Lane Assigned      : Lane-1
Application 14:
  | Host |
    Interface          : CAUI-4 C2M without FEC
    Application BR     : 103.13
    Lane Count         : 4
    Lane Sig BR        : 25.78125
    Modulation Format   : NRZ
    Bits Per Unit Intvl : 1
    Lane Assigned      : Lane-5/Lane-1
  | Media |
    Interface          : 100ZRP, DWDM, amplified 2000Km
    Application BR     : 120.277094

```

```
Lane Count      : 1
Lane Sig BR     : 30.069273
Modulation Format : DP-QPSK
Bits Per Unit Intvl : 4
Lane Assigned   : Lane-1
```

show qsfp-dd advertisement controls

Use this command to show **QSFP-DD**¹ module advertised controls.

Command Syntax

```
show qsfp-dd PORTNUM advertisement controls
```

Parameters

PORTNUM

QSFP-DD front panel port number

Command Mode

Execution mode and Privileged execution mode

Applicability

This command was introduced before OcNOS version 6.1.0.

Example

```
show qsfp-dd 0 advertisement controls

Port Number                : 0
Wavelength Control        : Yes
Tunable Transmitter       : Yes
Tx Output Squelching      : Not Supported
Forced Tx Output Squelching : No
Tx Output Squelching Disable : No
Tx Output Disable        : Yes
Input Polarity Flip Tx    : Yes
Rx Output Squelching Disable : Yes
Rx Output Disable        : Yes
Output Polarity Flip Rx   : Yes
```

¹QSFP-DD stands for Quad Small Form Factor Pluggable Double Density. QSFP-DD modules provide a scalable, high-bandwidth solution for data center networking, enabling efficient data transmission and network performance in modern computing environments.

show qsfp-dd advertisement diagnostics host

Use this command to show **QSFP-DD**¹ module advertised host side diagnostics.

Command Syntax

```
show qsfp-dd PORTNUM advertisement diagnostics host
```

Parameters

PORTNUM

QSFP-DD front panel port number

Command Mode

Execution mode and Privileged execution mode

Applicability

This command was introduced before OcNOS version 6.1.0.

Example

```
show qsfp-dd 0 advertisement diagnostics host

Port Number                : 0
| Supported Loopback Modes |
  Output                   : Yes
  Input                    : Yes
  Per Lane                 : Yes
| Reporting Capabilities |
  Input SNR                : No
  FEC                      : Yes
| PRBS Checker |
  Post FEC                 : Yes
  Pre FEC                  : Yes
  Types                   : PRBS-31Q, PRBS-31, PRBS-23Q, PRBS-23, PRBS-15Q, PRBS-15, PRBS-13Q,
PRBS-13, PRBS-9Q, PRBS-9, PRBS-7Q, PRBS-7
| PRBS Generator |
  Post FEC                 : Yes
  Pre FEC                  : Yes
  Types                   : PRBS-31Q, PRBS-31, PRBS-23Q, PRBS-23, PRBS-15Q, PRBS-15, PRBS-13Q,
PRBS-13, PRBS-9Q, PRBS-9, PRBS-7Q, PRBS-7
```

¹QSFP-DD stands for Quad Small Form Factor Pluggable Double Density. QSFP-DD modules provide a scalable, high-bandwidth solution for data center networking, enabling efficient data transmission and network performance in modern computing environments.

show qsfp-dd advertisement diagnostics media

Use this command to show **QSFP-DD**¹ module advertised media side diagnostics.

Command Syntax

```
show qsfp-dd PORTNUM advertisement diagnostics media
```

Parameters

PORTNUM

QSFP-DD front panel port number

Command Mode

Execution mode and Privileged execution mode

Applicability

This command was introduced before OcNOS version 6.1.0.

Example

```
show qsfp-dd 0 advertisement diagnostics media

Port Number                : 0
| Supported Loopback Modes |
  Output                   : Yes
  Input                    : No
  Per Lane                 : Yes
| Reporting Capabilities |
  Input SNR                : Yes
  FEC                      : Yes
| PRBS Checker |
  Post FEC                 : Yes
  Pre FEC                  : No
  Types                   : PRBS-31, PRBS-23, PRBS-15, PRBS-7
| PRBS Generator |
  Post FEC                 : Yes
  Pre FEC                  : Yes
  Types                   : PRBS-31, PRBS-23, PRBS-15, PRBS-7
```

¹QSFP-DD stands for Quad Small Form Factor Pluggable Double Density. QSFP-DD modules provide a scalable, high-bandwidth solution for data center networking, enabling efficient data transmission and network performance in modern computing environments.

show qsfp-dd advertisement diagnostics module

Use this command to show **QSFP-DD**¹ module advertised diagnostics.

Command Syntax

```
show qsfp-dd PORTNUM advertisement diagnostics module
```

Parameters

PORTNUM

QSFP-DD front panel port number

Command Mode

Execution mode and Privileged execution mode

Applicability

This command was introduced before OcNOS version 6.1.0.

Example

```
show qsfp-dd 0 advertisement diagnostics module
```

```
Port Number                : 0
| Supported Loopback Modes |
  Simul. Host & Media Side : Yes
| Reporting Capabilities |
  Bit Error Ratio          : Yes
  Bits & Errors Counting   : Yes
```

¹QSFP-DD stands for Quad Small Form Factor Pluggable Double Density. QSFP-DD modules provide a scalable, high-bandwidth solution for data center networking, enabling efficient data transmission and network performance in modern computing environments.

show qsfp-dd advertisement durations

Use this command to show module advertised durations

Command Syntax

```
show qsfp-dd PORTNUM advertisement durations
```

Parameters

PORTNUM

QSFP-DD¹ front panel port number

Command Mode

Execution mode and Privileged execution mode

Applicability

This command was introduced before OcNOS version 6.1.0.

Example

```
show qsfp-dd 0 advertisement durations

Port Number           : 0
ModSel Wait           : 4 us
DP Init Max           : 10 s <= t < 1 min
DP Deinit Max         : 1 s <= t < 5 s
DP Tx Turn On Max     : 50 ms <= t < 100 ms
DP Tx Turn Off Max    : 1 ms <= t < 5 ms
Module Power Up Max   : 10 s <= t < 1 min
Module Power Down Max : 1 s <= t < 5 s
```

¹QSFP-DD stands for Quad Small Form Factor Pluggable Double Density. QSFP-DD modules provide a scalable, high-bandwidth solution for data center networking, enabling efficient data transmission and network performance in modern computing environments.

show qsfp-dd advertisement laser

Use this command to show **QSFP-DD**¹ module advertised laser controls.

Command Syntax

```
show qsfp-dd PORTNUM advertisement laser
```

Parameters

PORTNUM

QSFP-DD front panel port number

Command Mode

Execution mode and Privileged execution mode

Applicability

This command was introduced before OcNOS version 6.1.0.

Example

```
show qsfp-dd 0 advertisement laser
```

```
Port Number : 0
Supported Grids : 6.25 GHz, 12.5 GHz, 25 GHz, 50 GHz, 100 GHz, 75 GHz
  6.25 GHz Channels : Low=191.275 THz, High=196.125 THz, Total=776
  12.5 GHz Channels : Low=191.275 THz, High=196.125 THz, Total=388
  25 GHz Channels : Low=191.275 THz, High=196.125 THz, Total=194
  50 GHz Channels : Low=191.300 THz, High=196.100 THz, Total=96
  100 GHz Channels : Low=191.300 THz, High=196.100 THz, Total=48
  75 GHz Channels : Low=191.300 THz, High=196.100 THz, Total=64
Fine Tuning Support : Yes
  Fine Tuning Resolution : 0.001 GHz
  Fine Tuning Low Offset : -6.000 GHz
  Fine Tuning High Offset : 6.000 GHz
Output Power Programmable Per Lane : Yes
  Min Output Power Programmable : -22.90 dBm
  Max Output Power Programmable : 4.00 dBm
```

¹QSFP-DD stands for Quad Small Form Factor Pluggable Double Density. QSFP-DD modules provide a scalable, high-bandwidth solution for data center networking, enabling efficient data transmission and network performance in modern computing environments.

show qsfp-dd advertisement monitors host

Use this command to show **QSFP-DD**¹ module advertised host side monitors.

Command Syntax

```
show qsfp-dd PORTNUM advertisement monitors host
```

Parameters

PORTNUM

QSFP-DD front panel port number

Command Mode

Execution mode and Privileged execution mode

Applicability

This command was introduced before OcNOS version 6.1.0.

Example

```
show qsfp-dd 0 advertisement monitors host

Port Number                : 0
Pre-FEC BER Minimum Input  : Yes [Lane 1, Lane 3, Lane 5, Lane 7]
Pre-FEC BER Maximum Input  : Yes [Lane 1, Lane 3, Lane 5, Lane 7]
Pre-FEC BER Average Input  : Yes [Lane 1, Lane 3, Lane 5, Lane 7]
Pre-FEC BER Current Value Input : Yes [Lane 1, Lane 3, Lane 5, Lane 7]
FERC Minimum Input         : Yes [Lane 1, Lane 3, Lane 5, Lane 7]
FERC Maximum Input         : Yes [Lane 1, Lane 3, Lane 5, Lane 7]
FERC Average Input         : Yes [Lane 1, Lane 3, Lane 5, Lane 7]
FERC Current Value Input   : Yes [Lane 1, Lane 3, Lane 5, Lane 7]

| Link Performance |
Tx FDD             : Yes
Tx FED             : Yes
```

¹QSFP-DD stands for Quad Small Form Factor Pluggable Double Density. QSFP-DD modules provide a scalable, high-bandwidth solution for data center networking, enabling efficient data transmission and network performance in modern computing environments.

show qsfp-dd advertisement monitors media

Use this command to show **QSFP-DD**¹ module advertised media side monitors.

Command Syntax

```
show qsfp-dd PORTNUM advertisement monitors media
```

Parameters

PORTNUM

QSFP-DD front panel port number

Command Mode

Execution mode and Privileged execution mode

Applicability

This command was introduced before OcNOS version 6.1.0.

Example

```
show qsfp-dd 0 advertisement monitors media

Port Number                : 0
Rx Optical Power           : Yes
Tx Optical Power           : Yes
Tx Bias                     : Yes
Rx Los                     : Yes
Tx Failure                  : Yes
Rx CDR LOL                 : Yes
Laser Age                  : Yes [Lane 1]
Pre-FEC BER Minimum Input  : Yes [Lane 1]
Pre-FEC BER Maximum Input  : Yes [Lane 1]
Pre-FEC BER Average Input  : Yes [Lane 1]
Pre-FEC BER Current Value Input : Yes [Lane 1]
FERC Minimum Input         : Yes [Lane 1]
FERC Maximum Input        : Yes [Lane 1]
FERC Average Input         : Yes [Lane 1]
FERC Current Value Input   : Yes [Lane 1]
Modular Bias X/I           : Yes [Lane 1]
Modular Bias X/Q           : Yes [Lane 1]
Modular Bias Y/I           : Yes [Lane 1]
Modular Bias Y/Q           : Yes [Lane 1]
Modular Bias X_Phase       : Yes [Lane 1]
Modular Bias Y_Phase       : Yes [Lane 1]
CD - high granularity, short link : Yes [Lane 1]
CD - low granularity, long link  : Yes [Lane 1]
DGD                        : Yes [Lane 1]
SOPMD - high granularity    : Yes [Lane 1]
PDL                        : Yes [Lane 1]
OSRN                       : Yes [Lane 1]
eSRN                       : Yes [Lane 1]
CFO                        : Yes [Lane 1]
```

¹QSFP-DD stands for Quad Small Form Factor Pluggable Double Density. QSFP-DD modules provide a scalable, high-bandwidth solution for data center networking, enabling efficient data transmission and network performance in modern computing environments.

```
Tx Power : Yes [Lane 1]
Rx Total Power : Yes [Lane 1]
Rx Signal Power : Yes [Lane 1]
SOP ROC : Yes [Lane 1]
SOPMD - low granularity : Yes [Lane 1]

| FEC Performance |
Rx Bits : Yes
Rx Correct Bits : Yes
Rx Frames : Yes
Rx Uncorrect Frames : Yes

| Link Performance |
Rx DSP CCD : Yes
Rx DSP DGD : Yes
Rx SOPM : Yes
Rx PDL : Yes
Rx oSNR : Yes
Rx eSNR : Yes
Rx CFO : Yes
Rx EvmModem : No
Tx Power : Yes
Rx Input Optical Power : Yes
Rx input Optical Signal Power : Yes
Rx SOPCR : Yes
Rx SOPMD Low Granularity : No
Rx Clock Recovery Monitor : No
Rx FDD : Yes
Rx FEC : Yes
```

show qsfp-dd advertisement monitors module

Use this command to show **QSFP-DD**¹ module advertised monitors

Command Syntax

```
show qsfp-dd PORTNUM advertisement monitors module
```

Parameters

PORTNUM

QSFP-DD front panel port number

Command Mode

Execution mode and Privileged execution mode

Applicability

This command was introduced before OcNOS version 6.1.0.

Example

```
show qsfp-dd 0 advertisement monitors module
```

```
Port Number           : 0
Voltage               : Yes
Temperature           : Yes
TEC Current           : Yes
Laser Temperature     : Yes
Laser Temperature [2] : No

Rx Power              : Yes
Rx Signal Power       : Yes
```

¹QSFP-DD stands for Quad Small Form Factor Pluggable Double Density. QSFP-DD modules provide a scalable, high-bandwidth solution for data center networking, enabling efficient data transmission and network performance in modern computing environments.

show qsfp-dd advertisement pages

Use this command to show **QSFP-DD**¹ module advertised supported pages.

Command Syntax

```
show qsfp-dd PORTNUM advertisement pages
```

Parameters

PORTNUM

QSFP-DD front panel port number

Command Mode

Execution mode and Privileged execution mode

Applicability

This command was introduced before OcNOS version 6.1.0.

Example

```
show qsfp-dd 0 application
```

```
Port Number                : 0
```

```
-----
```

User Config	H/W Config
None	Application 1

```
-----
```

```
OcNOS>show qsfp-dd 0 advertisement pages
```

```
Port Number                : 0
```

```
Network Path               : No
```

```
VDM                        : Yes
```

```
VDM Support                : Groups 1-2 (Page 20h-21h, 24h-25h, 28h-29h, first 1/2 of 2Ch, 2Dh)
```

```
Diagnostics                : Yes
```

```
User(Page 03h)             : Yes
```

```
Banks(Page 10h-1Fh)       : Bank 0 (8 Lanes)
```

¹QSFP-DD stands for Quad Small Form Factor Pluggable Double Density. QSFP-DD modules provide a scalable, high-bandwidth solution for data center networking, enabling efficient data transmission and network performance in modern computing environments.

show qsfp-dd advertisement si

Use this command to display which signal integrity configuration capabilities the transceiver supports.

Command Syntax

```
show qsfp-dd <port> advertisement si
```

Parameters

PORTNUM

QSFP-DD¹ front panel port number

Command Mode

Execution mode and Privileged execution mode

Applicability

This command was introduced before OcNOS version 6.5.1.

Example

```
#show qsfp-dd 0 advertisement si

-----
Codes
-----
Tx Equalization      >  1 - 12 : 1dB - 12db
                    >  13 - 15 : Vendor Specific
-----
Rx Pre-Cursor Eq    >  1 - 7  : 0.5 - 3.5dB
                    >  8 - 10 : Reserved
                    >  11 - 15 : Vendor Specific
-----
Rx Post-Cursor Eq   >  1 - 7  : 1 - 7dB
                    >  8 - 10 : Reserved
                    >  11 - 15 : Vendor Specific
-----
Rx Amplitude        >  0      : 100-400mV (P-P)
                    >  1      : 300-600mV (P-P)
                    >  2      : 400-800mV (P-P)
                    >  3      : 600-1200mV (P-P)
                    >  4 - 15 : Reserved
-----
Port Number          : 0
Manual Tx Input Eq.  : No
Rx Output Eq. Type   : P-P with constant amplitude/NA/Unknown
Rx Output Amplitude  : No
Rx Output Eq.        : Pre and post-cursor
Rx Output Eq. Pre-Cursor Max : Code 7 (3.5dB)
```

¹QSFP-DD stands for Quad Small Form Factor Pluggable Double Density. QSFP-DD modules provide a scalable, high-bandwidth solution for data center networking, enabling efficient data transmission and network performance in modern computing environments.

Rx Output Eq. Post-Cursor Max : Code 7 (7dB)

Tx CDR Supported : Yes

Tx CDR Bypass Supported : No

Rx CDR Supported : Yes

Rx CDR Bypass Supported : No

show qsfp-dd si status

Use this command to display what is the current signal integrity configuration status. It displays what is the current user configuration and what are the values programmed in the transceiver hardware.

Command Syntax

```
show qsfp-dd <port> si status
```

Parameters

PORTNUM

QSFP-DD¹ front panel port number

Command Mode

Execution mode and Privileged execution mode

Applicability

This command was introduced before OcNOS version 6.5.1.

Example

```
#show qsfp-dd 0 si status
```

```
Port Number           : 0
```

Parameter	Lane	User Config	H/W Config
Rx Pre-Cursor Eq	1	None	11
	2	None	11
	3	None	11
	4	None	11
	5	None	11
	6	None	11
	7	None	11
	8	None	11
Rx Post-Cursor Eq	1	None	11
	2	None	11
	3	None	11
	4	None	11
	5	None	11
	6	None	11
	7	None	11
	8	None	11
Tx CDR Bypass	1	None	Disabled
	2	None	Disabled
	3	None	Disabled
	4	None	Disabled
	5	None	Disabled

¹QSFP-DD stands for Quad Small Form Factor Pluggable Double Density. QSFP-DD modules provide a scalable, high-bandwidth solution for data center networking, enabling efficient data transmission and network performance in modern computing environments.

```
      | 6 | None | Disabled |
      | 7 | None | Disabled |
      | 8 | None | Disabled |
-----
Rx CDR Bypass | 1 | None | Disabled |
               | 2 | None | Disabled |
               | 3 | None | Disabled |
               | 4 | None | Disabled |
               | 5 | None | Disabled |
               | 6 | None | Disabled |
               | 7 | None | Disabled |
               | 8 | None | Disabled |
-----
```

show qsfp-dd application

Use this command to show **QSFP-DD**¹ module current selected application.

Command Syntax

```
show qsfp-dd PORTNUM application
```

Parameters

PORTNUM

QSFP-DD front panel port number

Command Mode

Execution mode and Privileged execution mode

Applicability

This command was introduced before OcNOS version 6.1.0.

Example

```
show qsfp-dd 0 application
```

```
Port Number                : 0
-----
User Config | H/W Config
-----
None        | Application 1
```

¹QSFP-DD stands for Quad Small Form Factor Pluggable Double Density. QSFP-DD modules provide a scalable, high-bandwidth solution for data center networking, enabling efficient data transmission and network performance in modern computing environments.

show qsfp-dd diagnostics host

Use this command to show **QSFP-DD**¹ module host side diagnostics information.

Command Syntax

```
show qsfp-dd PORTNUM diagnostics host
```

Parameters

PORTNUM

QSFP-DD front panel port number

Command Mode

Execution mode and Privileged execution mode

Applicability

This command was introduced before OcNOS version 6.1.0.

Example

```
show qsfp-dd 0 diagnostics host
```

```
Port Number : 0
```

Attribute	Lane	Value
Bit Error Ratio	1	0.00e+00
	2	0.00e+00
	3	0.00e+00
	4	0.00e+00
	5	0.00e+00
	6	0.00e+00
	7	0.00e+00
	8	0.00e+00
Bit Error Ratio(G)	1	0.00e+00
	2	0.00e+00
	3	0.00e+00
	4	0.00e+00
	5	0.00e+00
	6	0.00e+00
	7	0.00e+00
	8	0.00e+00
Error Count	1	0
	2	0
	3	0
	4	0
	5	0
	6	0
	7	0
	8	0
Bit Count	1	0
	2	0

¹QSFP-DD stands for Quad Small Form Factor Pluggable Double Density. QSFP-DD modules provide a scalable, high-bandwidth solution for data center networking, enabling efficient data transmission and network performance in modern computing environments.

		3		0	
		4		0	
		5		0	
		6		0	
		7		0	
Error Count (G)		8		0	
		1		0	
		2		0	
		3		0	
		4		0	
		5		0	
		6		0	
		7		0	
Bit Count (G)		8		0	
		1		0	
		2		0	
		3		0	
		4		0	
		5		0	
		6		0	
		7		0	
		8		0	

show qsfp-dd diagnostics media

Use this command to show **QSFP-DD**¹ module media side diagnostics information.

Command Syntax

```
show qsfp-dd PORTNUM diagnostics media
```

Parameters

PORTNUM

QSFP-DD front panel port number

Command Mode

Execution mode and Privileged execution mode

Applicability

This command was introduced before OcNOS version 6.1.0.

Example

```
show qsfp-dd 0 diagnostics media
```

```
Port Number                : 0
```

Attribute	Lane	Value
Signal To Noise Ratio	1	0.00
Bit Error Ratio	1	0.00e+00
Bit Error Ratio(G)	1	0.00e+00
Error Count	1	0
Bit Count	1	0
Error Count(G)	1	0
Bit Count(G)	1	0

¹QSFP-DD stands for Quad Small Form Factor Pluggable Double Density. QSFP-DD modules provide a scalable, high-bandwidth solution for data center networking, enabling efficient data transmission and network performance in modern computing environments.

show qsfdd eeprom

Use this command to show **QSFP-DD**¹ module EEPROM information.

Command Syntax

```
show qsfdd PORTNUM eeprom
```

Parameters

PORTNUM

QSFP-DD front panel port number

Command Mode

Execution mode and Privileged execution mode

Applicability

This command was introduced before OcNOS version 6.1.0.

Example

```
show qsfdd 0 eeprom

Port Number           : 0
Identifier            : QSFP-DD Double Density 8X Pluggable Transceiver
Name                  : SmartOptics
OUI                   : 0x0 0x53 0x4f
Part No               : SO-TQSFDD4CCZRP
Revision Level        : A
Serial Number         : 214156190
Manufacturing Date    : 220318 (yyymmddvv, v=vendor specific)
Module Power Class    : 8
Module Max Power      : 23.75 Watt
Cooling Implemented   : Yes
Module Temperature Max : 80 Celsius
Module Temperature Min : 0 Celsius
Operating Voltage Min : 3.12 Volt
Optical Detector      : PIN
Rx Power Measurement  : Average Power
Tx Disable Module Wide : No
Cable Assembly Link Length : Separable Media
Connector Type        : LC (Lucent Connector)
Media Interface Technology : 1550 nm DFB
CMIS Revision         : 4.1
Memory Model          : Paged
MCI Max Speed         : 1000 kHz
Active Firmware Revision : 61.20
Inactive Firmware Revision : 61.20
Hardware Revision     : 49.48
Media Type             : Optical SMF
Max SMF Link Length   : 630.0 Kilometer
Wavelength Nominal    : 1547.70 nm
Wavelength Tolerance  : 166.55 nm
```

¹QSFP-DD stands for Quad Small Form Factor Pluggable Double Density. QSFP-DD modules provide a scalable, high-bandwidth solution for data center networking, enabling efficient data transmission and network performance in modern computing environments.

show qsfp-dd laser grid

Use this command to show **QSFP-DD**¹ module laser grid spacing information for frequencies of 3.125, 6.25, 12.5, 25, 33, 50, 75 and 100 GHz.

Command Syntax

```
show qsfp-dd PORTNUM laser grid (3p125|6p25|12p5|25|33|50|75|100)
```

Parameters

PORTNUM

QSFP-DD front panel port number

3p125

3.125 GHz

6p25

6.25 GHz

12p5

12.5 GHz

25

25 GHz

33

33 GHz

50

50 GHz

75

75 GHz

100

100 GHz

Default

None

Command Mode

Execution mode and Privileged execution mode.

Applicability

This command was introduced in OcNOS version 6.2.0.

Example

```
show qsfp-dd 0 laser grid 100
```

¹QSFP-DD stands for Quad Small Form Factor Pluggable Double Density. QSFP-DD modules provide a scalable, high-bandwidth solution for data center networking, enabling efficient data transmission and network performance in modern computing environments.

Port Number : 0

```
-----  
Channel Number  Frequency (THz)  Wavelength (nm)  
-----  
-18             191.300000          1567.133  
-17             191.400000          1566.314  
-16             191.500000          1565.496  
-15             191.600000          1564.679  
-14             191.700000          1563.863  
-13             191.800000          1563.047  
-12             191.900000          1562.233  
-11             192.000000          1561.419  
-10             192.100000          1560.606  
-9              192.200000          1559.794  
-8              192.300000          1558.983  
-7              192.400000          1558.173  
-6              192.500000          1557.363  
-5              192.600000          1556.555  
-4              192.700000          1555.747  
-3              192.800000          1554.940  
-2              192.900000          1554.134  
-1              193.000000          1553.329  
0               193.100000          1552.524  
1               193.200000          1551.721  
2               193.300000          1550.918  
3               193.400000          1550.116  
4               193.500000          1549.315  
5               193.600000          1548.515  
6               193.700000          1547.715  
7               193.800000          1546.917  
8               193.900000          1546.119  
9               194.000000          1545.322  
10              194.100000          1544.526  
11              194.200000          1543.730  
12              194.300000          1542.936  
13              194.400000          1542.142  
14              194.500000          1541.349  
15              194.600000          1540.557  
16              194.700000          1539.766  
17              194.800000          1538.976  
18              194.900000          1538.186  
19              195.000000          1537.397  
20              195.100000          1536.609  
21              195.200000          1535.822  
22              195.300000          1535.036  
23              195.400000          1534.250  
24              195.500000          1533.465  
25              195.600000          1532.681  
26              195.700000          1531.898  
27              195.800000          1531.116  
28              195.900000          1530.334  
29              196.000000          1529.553  
30              196.100000          1528.773
```

show qsfp-dd laser status

Use this command to show **QSFP-DD**¹ module current laser configuration status and alarm flags.

Command Syntax

```
show qsfp-dd PORTNUM laser status
```

Parameters

PORTNUM

QSFP-DD front panel port number

Default

None

Command Mode

Execution mode and Privileged execution mode.

Applicability

This command was introduced in OcNOS version 6.2.0.

Example

```
show qsfp-dd 0 laser status
```

```
Port Number      : 0
```

```
-----
Attribute      | Lane | Value  | Unit |
-----
Grid Spacing   | 1    | 100.000 | GHz  |
Laser Frequency | 1    | 191.900000 | THz  |
Channel Number | 1    | -12     | --   |
Wavelength     | 1    | 1562.23 | nm   |
-----
```

```
-----
Flag           | Lane | Status |
-----
Tuning in progress | 1    | No     |
Wavelength locked | 1    | Yes    |
-----
```

```
-----
Flag           | Lane | Status (L) |
-----
Target output power OOR | 1    | No         |
Fine tuning out of range | 1    | No         |
Tuning accepted         | 1    | Yes        |
Channel number valid    | 1    | Yes        |
-----
```

¹QSFP-DD stands for Quad Small Form Factor Pluggable Double Density. QSFP-DD modules provide a scalable, high-bandwidth solution for data center networking, enabling efficient data transmission and network performance in modern computing environments.

show qsfp-dd monitors host

Use this command to show **QSFP-DD**¹ module host side monitors information.

Command Syntax

```
show qsfp-dd PORTNUM monitors host
```

Parameters

PORTNUM

QSFP-DD front panel port number

Command Mode

Execution mode and Privileged execution mode

Applicability

This command was introduced before OcNOS version 6.1.0.

Example

```
show qsfp-dd 0 monitors host
```

```
Alarm Codes: FDD - FEC Detected Degrade, FED - FEC Excessive Degrade
LD - Local Degrade, RD - Remote Degrade
FLOPB - Flexe Loss of Pad Block, FLOMF - Flexe Loss of Multi-Frame
FLOF - Flexe Loss of Frame, FIIDM - Flexe Instance Id Mismatch
FCM - Flexe Calendar Mismatch, FIMM - Flexe Instance Map Mismatch
FGIDM - Flexe GID Mismatch, TLF - Transmit Local Fault
TRF - Transmit Remote Fault, TLOA - Transmit Loss of Alignment
RLF - Receive Local Fault, RRF - Receive Remote Fault
RLOA - Receive Loss of Alignment
```

```
Port Number          : 0
-----
Flag                | Lane | Status (L) |
-----
Tx LOS              | 1   | False      |
                   | 2   | False      |
                   | 3   | False      |
                   | 4   | False      |
                   | 5   | False      |
                   | 6   | False      |
                   | 7   | False      |
                   | 8   | False      |
Tx CDR LOL         | 1   | False      |
                   | 2   | False      |
                   | 3   | False      |
                   | 4   | False      |
                   | 5   | False      |
                   | 6   | False      |
                   | 7   | False      |
                   | 8   | False      |
```

¹QSFP-DD stands for Quad Small Form Factor Pluggable Double Density. QSFP-DD modules provide a scalable, high-bandwidth solution for data center networking, enabling efficient data transmission and network performance in modern computing environments.

Tx Adaptive Input Eq	1	Good
	2	Good
	3	Good
	4	Good
	5	Good
	6	Good
	7	Good
	8	Good

 Host Performance

Attribute	Lane	Value
Alarm Status	1	LD

 FEC Performance

Attribute	Lane	Value
Tx Bits	1	2125037470720
Tx Corrected Bits	1	0
Tx Frames	1	390631888
Tx Uncorrected Frames	1	0

show qsfp-dd monitors media

Use this command to show **QSFP-DD¹** module media side monitors information.

Command Syntax

```
show qsfp-dd PORTNUM monitors media
```

Parameters

PORTNUM

QSFP-DD front panel port number

Command Mode

Execution mode and Privileged execution mode

Applicability

This command was introduced before OcNOS version 6.1.0.

Example

```
show qsfp-dd 0 monitors media
```

```
Alarm Codes: TFIFO - Tx FIFO Error, TLOLDS - Tx Deskew Loss of Lock
              TL0LRC - Tx Reference Clock Loss of Lock, TL0LCMU - Tx CMU Loss of Lock
              TOO0A - Tx Out of Alignment, TLO0A - Tx Loss of Alignment
              RFIFO - Rx FIFO Error, RLOLDS - Tx Deskew Loss of Lock
              RO0OA - Rx Out of Alignment, RLO0A - Rx Loss of Alignment
              RLOLCD - Rx Chromatic Dispersion Compensation Loss of Lock
              RLOLD - Tx Demodulator Loss of Lock, RLOM - Rx Loss of Multi Frame
              RLOF - Rx Loss of Frame, FDD - FEC Detected Degrade
              FED - FEC Excessive Degrade, RPF - Remote Phy Fault
              LD - Local Degrade, RD - Remote Degrade
```

```
Codes: [HA : High Alarm], [LA : Low Alarm], [HW : High Warning], [LW : Low Warning]
```

```
Port Number          : 0
```

```
-----
Monitors              | Lane | Value          | High Alarm | High Warning | Low Warning | Low
Alarm | Unit |
-----
Rx Optical Power     | 1    | -18.9          | 2.0        | 0.0          | -23.0       | -
28.2 | dBm |
Tx Optical Power     | 1    | -7.8           | 0.0        | -2.0         | -16.0       | -
18.0 | dBm |
Tx
Bias                  | 1    | 287.3          | 0.0        | 0.0          | 0.0         | 0.0
| mA |
-----
```

```
-----
Flag | Lane | Status (L) |
-----
```

¹QSFP-DD stands for Quad Small Form Factor Pluggable Double Density. QSFP-DD modules provide a scalable, high-bandwidth solution for data center networking, enabling efficient data transmission and network performance in modern computing environments.

```

-----
Rx LOS                | 1 | False |
Tx Failure            | 1 | False |
Rx CDR LOL           | 1 | False |
-----
    
```

Link Performance

```

-----
Attribute            | Lane | Average | Minimum | Maximum | Unit |
-----
Rx DSP CCD           | 1   | -1      | -1      | -1      | ps/nm |
Rx DSP DGD           | 1   | 1.00    | 1.00    | 1.00    | ps    |
Rx SOPMD             | 1   | 40.00   | 40.00   | 40.00   | ps^2  |
Rx PDL               | 1   | 0.5     | 0.5     | 0.5     | dB    |
Rx OSNR              | 1   | 36.4    | 36.4    | 36.4    | dB    |
Rx ESNR              | 1   | 16.4    | 16.4    | 16.4    | dB    |
Rx CFO               | 1   | 86      | 14      | 158     | MHz   |
Tx Power             | 1   | -7.77   | -7.78   | -7.76   | dBm   |
Rx Input Optical Power | 1   | -18.90  | -18.91  | -18.90  | dBm   |
Rx Input Optical Signal Power | 1   | -19.18  | -19.19  | -19.18  | dBm   |
Rx SOPCR             | 1   | 0       | 0       | 0       | krads/s |
Rx MER               | 1   | 0.0     | 0.0     | 0.0     | dB    |
-----
    
```

```

Alarm Status        | 1 | RLOLCD, RLOLD, RPF |
-----
    
```

FEC Performance

```

-----
Attribute            | Lane | Value |
-----
Rx Bits              | 1   | 462238792192 |
Rx Corrected Bits    | 1   | 1398045784   |
Rx Frames            | 1   | 902810141    |
Rx Uncorrected Frames | 1   | 0             |
-----
    
```

show qsfp-dd monitors module

Use this command to show **QSFP-DD**¹ module monitors information.

Command Syntax

```
show qsfp-dd PORTNUM monitors module
```

Parameters

PORTNUM

QSFP-DD front panel port number

Command Mode

Execution mode and Privileged execution mode

Applicability

This command was introduced before OcNOS version 6.1.0.

Example

```
show qsfp-dd 0 monitors module
```

```
Codes: [HA : High Alarm], [LA : Low Alarm], [HW : High Warning], [LW : Low Warning]
```

```
Port Number           : 0
```

```
-----
Attribute              | Value      | High Alarm | High Warning | Low Warning | Low
Alarm      | Units      |            |             |            |
-----
Voltage          | 3.24       | 3.46       | 3.43        | 3.17       |
3.13            | Volt
Temperature      | 42.0       | 80.0       | 75.0        | 15.0       |
5.0             | Celsius
TEC Current Magnitude | 63.000    | 100.00    | 100.00     | -100.00    |
100.00          | %
Laser Temperature | 43.000    | 80.00     | 75.00      | -40.00    |
80.00           | Celsius
-----
```

¹QSFP-DD stands for Quad Small Form Factor Pluggable Double Density. QSFP-DD modules provide a scalable, high-bandwidth solution for data center networking, enabling efficient data transmission and network performance in modern computing environments.

show qsfp-dd state

Use this command to show **QSFP-DD**¹ module current state information.

Command Syntax

```
show qsfp-dd PORTNUM state
```

Parameters

PORTNUM

QSFP-DD front panel port number

Command Mode

Execution mode and Privileged execution mode

Applicability

This command was introduced before OcNOS version 6.1.0.

Example

```
show qsfp-dd 0 state

Port Number           : 0
Module Fault State    : No fault
Module State          : Ready
  Data Path State      : Activated [Starting On : Lane-1]
```

¹QSFP-DD stands for Quad Small Form Factor Pluggable Double Density. QSFP-DD modules provide a scalable, high-bandwidth solution for data center networking, enabling efficient data transmission and network performance in modern computing environments.

show qsfp-dd user-threshold status

Use this command to show the current configuration status of user thresholds.

Command Syntax

```
show qsfp-dd <PORT> user-threshold status (host|media)
```

Parameters

PORT

The front panel port number of the device where the transceiver is connected

host

Host side config status

media

Media side config status

Command Mode

Execution mode and Privileged execution mode mode.

Applicability

This command was introduced in OcNOS version 6.4.1.

Example

This below show command displays the hardware state of the programmed user thresholds.
OcNOS#show qsfp-dd 48 user-threshold status host

```
Port Number           : 48
```

Threshold	Lane	User Config	H/W Config	Minimum	Maximum
Tx FDD Active	1	9.88e-01	9.87e-01	0.00e+00	1.00e+00
Tx FDD Clear	1	5.43e-03	5.43e-03	0.00e+00	1.00e+00
Tx FED Active	1	5.43e-01	5.43e-01	0.00e+00	1.00e+00
Tx FED Clear	1	9.88e-03	9.87e-03	0.00e+00	1.00e+00

```
OcNOS#show qsfp-dd 48 user-threshold status media
```

```
Codes: [HA : High Alarm], [LA : Low Alarm], [HW : High Warning], [LW : Low Warning]
```

```
Port Number           : 48
```

Threshold	Lane	User Config	H/W Config	Minimum	Maximum
Rx FDD Active	1	1.23e-01	1.23e-01	0.00e+00	1.00e+00
Rx FDD Clear	1	6.79e-03	6.78e-03	0.00e+00	1.00e+00
Rx FED Active	1	6.79e-01	6.78e-01	0.00e+00	1.00e+00
Rx FED Clear	1	1.23e-03	1.23e-03	0.00e+00	1.00e+00
Rx Total Power HA	1	4.00	4.00	-26.00	9.00
Rx Total Power HW	1	3.00	3.00	-26.00	9.00
Rx Total Power LW	1	-3.00	-3.00	-26.00	9.00
Rx Total Power LA	1	-4.00	-4.00	-26.00	9.00

```

Rx Signal Power HA | 1 | 2.00 | 2.00 | -26.00 | 9.00 |
Rx Signal Power HW | 1 | 1.00 | 1.00 | -26.00 | 9.00 |
Rx Signal Power LW | 1 | -1.00 | -1.00 | -26.00 | 9.00 |
Rx Signal Power LA | 1 | -2.00 | -2.00 | -26.00 | 9.00 |

```

Table 72. show qsfm-dd 48 user-threshold status host output details

Field	Description
Threshold	The parameters that are monitored.
Lane	Displays the channel number where the thresholds are applied.
User Config	Displays what the user has configured.
H/W Config	Displays what is programmed in the transceiver hardware.
Minimum	The lowest values that are allowed to be used for this configuration.
Maximum	The highest values that are allowed to be used for this configuration.

tx-input eq-target

Use this command to configure the Tx input equalizer target override value.

Use the no form of this command to remove the Tx input equalizer target override value.

Command Syntax

```
tx-input eq-target <1-15>
no tx-input eq-target
```

Parameters

<1-15>

Input equalizer target value

Default

None

Command Mode

QSFP-DD¹ mode and QSFP-DD host-lane mode

Applicability

This command was introduced before OcNOS version 6.5.1.

Example

```
#configure terminal
(config)#qsfp-dd 0
(config-qsfp-dd)#tx-input eq-target 1
(config-qsfp-dd)#commit
(config-qsfp-dd)#no tx-input eq-target
(config-qsfp-dd)#commit
(config-qsfp-dd)#host-lane 3
(config-qsfp-dd-host)#tx-input eq-target 5
(config-qsfp-dd-host)#commit
(config-qsfp-dd-host)#no tx-input eq-target
(config-qsfp-dd-host)#commit
```

¹QSFP-DD stands for Quad Small Form Factor Pluggable Double Density. QSFP-DD modules provide a scalable, high-bandwidth solution for data center networking, enabling efficient data transmission and network performance in modern computing environments.

tx cdr-bypass

Use this command to enable the Tx CDR bypass.

Use the no form of this command to disable the Tx CDR bypass.

Command Syntax

```
tx cdr-bypass
no tx cdr-bypass
```

Parameters

None

Command Mode

QSFP-DD¹ mode and QSFP-DD host-lane mode modes

Applicability

This command was introduced before OcNOS version 6.5.1.

Example

```
#configure terminal
(config)#qsfp-dd 0
(config-qsfp-dd)#tx cdr-bypass
(config-qsfp-dd)#commit
(config-qsfp-dd)#no tx cdr-bypass
(config-qsfp-dd)#commit
(config-qsfp-dd)#host-lane 2
(config-qsfp-dd-host)#tx cdr-bypass
(config-qsfp-dd-host)#commit
(config-qsfp-dd-host)#no tx cdr-bypass
(config-qsfp-dd-host)#commit
```

¹QSFP-DD stands for Quad Small Form Factor Pluggable Double Density. QSFP-DD modules provide a scalable, high-bandwidth solution for data center networking, enabling efficient data transmission and network performance in modern computing environments.

threshold (host-lane mode)

Use this command to enter host lane level user threshold configuration mode. **Host lane**¹ mode is a configuration mode that allows configuring specific values for the host lanes. Host lanes are wires that carry the electrical signal from the host interface to the module and vice-versa.

Command Syntax

```
threshold (tx-fdd|tx-fed)
```

Parameters

tx-fdd

Tx FDD²

tx-fed

Tx FED³

Command Mode

Host-lane mode⁴

Applicability

This command was introduced in OcNOS version 6.4.1.

Example

The below configuration shows to configure the host-lane threshold:

```
OcNOS#configure terminal
OcNOS (config) #qsfp-dd 48
OcNOS (config-qsfp-dd) #host-lane 1
OcNOS (config-qsfp-dd-host) #threshold tx-fdd
OcNOS (config-qsfp-dd-host-thresh) #ha 0.9876
OcNOS (config-qsfp-dd-host-thresh) #la 0.005432
OcNOS (config-qsfp-dd-host-thresh) #threshold tx-fed
OcNOS (config-qsfp-dd-host-thresh) #ha 0.5432
OcNOS (config-qsfp-dd-host-thresh) #la 0.009876
OcNOS (config-qsfp-dd-host-thresh) #commit
```

¹Host lanes are wires that carry the electrical signal from the host interface to the module and vice-versa.

²FEC Detected Degrade suggests that the FEC has detected errors in data transmission. The alarm notification is triggered if the average BER exceeds the configured FDD value.

³FEC Excessive Degrade suggests that the FEC has detected very high errors in data transmission. FED is a more severe error condition than FDD and needs more attention. The alarm notification is triggered if the average BER exceeds the configured FED value.

⁴Host lane mode is a configuration mode that allows configuring specific values for the host lanes. Contrary to the global mode level that configures the same value across all host lanes.

threshold (media-lane mode)

Use this command to enter media lane level user threshold configuration mode. **Media lane**¹ mode is a configuration mode that allows configuring specific values for each media lane. Media lanes are the electrical wire pairs (copper cables) or optical fibers that carry signals from the module to the other router and vice-versa.

Command Syntax

```
threshold (rx-fdd|rx-fed|rx-total-power|rx-signal-power)
```

Parameters

rx-fddRx FDD²**rx-fed**Rx FED³**rx-total-power**

Rx Total Power

rx-signal-power

Rx Signal Power

Command Mode

Media-lane mode⁴

Applicability

This command was introduced in OcNOS version 6.4.1.

Example

The below configuration shows to configure the media-lane threshold:

```
OcNOS#configure terminal
OcNOS (config)#qsfp-dd 48
OcNOS (config-qsfp-dd)#media-lane 1
OcNOS (config-qsfp-dd-media)#threshold rx-fdd
OcNOS (config-qsfp-dd-media-thresh)#ha 0.1234
OcNOS (config-qsfp-dd-media-thresh)#la 0.006789
OcNOS (config-qsfp-dd-media-thresh)#threshold rx-fed
OcNOS (config-qsfp-dd-media-thresh)#ha 0.6789
OcNOS (config-qsfp-dd-media-thresh)#la 0.001234
OcNOS (config-qsfp-dd-media-thresh)#threshold rx-total-power
OcNOS (config-qsfp-dd-media-thresh)#ha 4
OcNOS (config-qsfp-dd-media-thresh)#hw 3
```

¹Media lanes are the electrical wire pairs (copper cables) or optical fibers that carry signals from the module to the other router and vice-versa.

²FEC Detected Degrade suggests that the FEC has detected errors in data transmission. The alarm notification is triggered if the average BER exceeds the configured FDD value.

³FEC Excessive Degrade suggests that the FEC has detected very high errors in data transmission. FED is a more severe error condition than FDD and needs more attention. The alarm notification is triggered if the average BER exceeds the configured FED value.

⁴Media lane mode is a configuration mode that allows configuring specific values for each media lane (per fiber cable physical channel). Contrary to the global mode level that configures the same value across all media lanes.

```
OcNOS (config-qsfp-dd-media-thresh)#lw -3
OcNOS (config-qsfp-dd-media-thresh)#la -4
OcNOS (config-qsfp-dd-media-thresh)#threshold rx-signal-power
OcNOS (config-qsfp-dd-media-thresh)#ha 2
OcNOS (config-qsfp-dd-media-thresh)#hw 1
OcNOS (config-qsfp-dd-media-thresh)#lw -1
OcNOS (config-qsfp-dd-media-thresh)#la -2
OcNOS (config-qsfp-dd-media-thresh)#commit
```

threshold (QSFP-DD mode)

Use this command to enter global level user threshold configuration mode. In global mode, configure the same threshold value across all host or media lanes.

Command Syntax

```
threshold (tx-fdd|tx-fed|rx-fdd|rx-fed|rx-total-power|rx-signal-power)
```

Parameters

tx-fddTx FDD¹**tx-fed**Tx FED²**rx-fdd**

Rx FDD

rx-fed

Rx FED

rx-total-power

Rx Total Power

rx-signal-power

Rx Signal Power

Command Mode

QSFP-DD³ mode

Applicability

This command was introduced in OcNOS version 6.4.1.

Example

The below configuration shows to configure the threshold in global mode:

```
OcNOS#configure terminal
OcNOS(config)#qsfp-dd 48
OcNOS(config-qsfp-dd)#threshold tx-fdd
OcNOS(config-qsfp-dd-thresh)#ha 0.9876
OcNOS(config-qsfp-dd-thresh)#la 0.005432
OcNOS(config-qsfp-dd-thresh)#threshold tx-fed
OcNOS(config-qsfp-dd-thresh)#ha 0.5432
OcNOS(config-qsfp-dd-thresh)#la 0.009876
```

¹FEC Detected Degrade suggests that the FEC has detected errors in data transmission. The alarm notification is triggered if the average BER exceeds the configured FDD value.

²FEC Excessive Degrade suggests that the FEC has detected very high errors in data transmission. FED is a more severe error condition than FDD and needs more attention. The alarm notification is triggered if the average BER exceeds the configured FED value.

³QSFP-DD stands for Quad Small Form Factor Pluggable Double Density. QSFP-DD modules provide a scalable, high-bandwidth solution for data center networking, enabling efficient data transmission and network performance in modern computing environments.

```
OcNOS (config-qsfp-dd-thresh)#threshold rx-fdd
OcNOS (config-qsfp-dd-thresh)#ha 0.1234
OcNOS (config-qsfp-dd-thresh)#la 0.006789
OcNOS (config-qsfp-dd-thresh)#threshold rx-fed
OcNOS (config-qsfp-dd-thresh)#ha 0.6789
OcNOS (config-qsfp-dd-thresh)#la 0.001234
OcNOS (config-qsfp-dd-thresh)#threshold rx-total-power
OcNOS (config-qsfp-dd-thresh)#ha 4
OcNOS (config-qsfp-dd-thresh)#hw 3
OcNOS (config-qsfp-dd-thresh)#lw -3
OcNOS (config-qsfp-dd-thresh)#la -4
OcNOS (config-qsfp-dd-thresh)#threshold rx-signal-power
OcNOS (config-qsfp-dd-thresh)#ha 2
OcNOS (config-qsfp-dd-thresh)#hw 1
OcNOS (config-qsfp-dd-thresh)#lw -1
OcNOS (config-qsfp-dd-thresh)#la -2
OcNOS (config-qsfp-dd-thresh)#commit
```

| EDFA CONFIGURATION GUIDE

Erbium-Doped Fiber Amplifier (EDFA) Configuration	1068
Overview	1068
System Description	1068
Objectives	1068
Topology	1069
Configuration	1069
Validation	1070

Erbium-Doped Fiber Amplifier (EDFA) Configuration

Overview

Before the development of optical amplifiers, optical signals had to be converted into electrical signals, then amplified, and subsequently transformed back into optical signals. This was a very complicated and expensive process. To avoid this complexity, optical amplifiers are developed, enabling the direct amplification of optical signals without the need for conversion. This streamlined approach significantly reduced costs.

Various types of optical amplifiers include:

- Semiconductor Optical Amplifier (SOA)
- Raman Amplifiers
- Brillouin Amplifiers
- Erbium-Doped Fiber Amplifier (EDFA)

Erbium-Doped Fiber Amplifier (EDFA) uses erbium-doped fiber as an amplification medium and are extensively deployed in Wavelength Division Multiplexing (WDM) systems. It can amplify multiple optical signals simultaneously and is commonly used in the C-band and L-band.

System Description

Basically, the system will be developed to combine the input signal with the pump light using a WDM coupler. This combined signal is then directed into the EDF. Within the EDF, the pump light initiates a process called population inversion, and the input signal undergoes amplification through stimulated emission.

To ensure stable signal amplification and prevent undesired back reflections from the output port, isolators are strategically placed at both the input and output ends. Additionally, the presence of isolators prevents the amplifier from functioning as a laser.

The wavelength of the pump LD is precisely controlled and maintained close to 980nm.

These optical and communication systems operate in two different modes.

Automatic Power Control

In Automatic Power Control (APC) mode, the microprocessor controls the output power by adjusting the pump laser to maintain a predefined reference output power level. This control mechanism ensures the output power remains constant, even when the input power fluctuates within the dynamic range.

Automatic Gain Control

In Automatic Gain Control (AGC) mode, the microprocessor controls the output power to maintain the specified gain relative to the input power. The expected output power cannot be guaranteed, if the input power falls below the minimum assured input power range.

Objectives

The objective of this document is to provide the application of EDFA as a booster amplifier, Inline amplifier, and pre-amplifier.

- **Booster Amplifier:** The booster amplifier (BA) is placed just after the transmitter to increase the optical power launched to the transmission line. It's not always required in single-channel links but is an essential part of the DWDM link where the multiplexer attenuates the signal channels. It has high input power, high output power, and medium optical gain.
- **Inline Amplifier:** The inline amplifiers are placed in the transmission line, compensating for the attenuation induced by the optical fiber. The in-line EDFA is designed for optical amplification between two network nodes on the main optical link. In-line EDFAs are placed every 80-100 km to ensure that the optical signal level remains above the noise floor. It features medium to low input power, high output power, high optical gain, and a low noise figure.
- **Pre-Amplifier:** The pre-amplifier (PA) is placed just before the receiver, such that sufficient optical power is launched to the receiver. It has relatively low input power, medium output power, and medium gain.

Support added for the DDM parameters specific to the EDFA available in the QSFP28 form factor. This application supports the reading of In-power, Out-power, pump BIAS, and gain. Additionally, it will enable the configuration of the target out-power and the continuous monitoring of these attributes in accordance with the specified thresholds.

Topology

Figure 56. EDFA Sample Topology

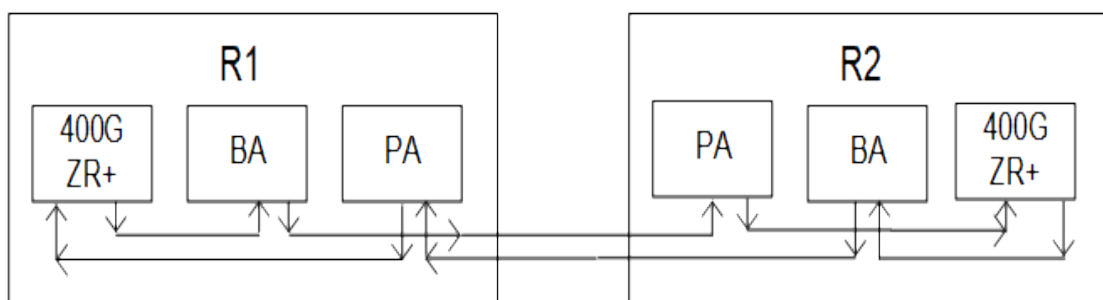

Configuration

R1

<code>#configure terminal</code>	Enter into configure mode.
<code>(config)#interface ce15</code>	Enter into interface mode.
<code>(config-if)#edfa operating-mode agc</code>	Enable the EDFA operating mode AGC.
<code>(config-if)#edfa target-gain 5</code>	Specify the desired EDFA gain value.
<code>(config-if)#commit</code>	Commit the candidate configuration to the running configuration.
<code>(config-if)#exit</code>	Exit the router mode.
<code>(config)#interface ce15</code>	Enter into interface mode.
<code>(config-if)#edfa operating-mode apc</code>	Enable the EDFA operating mode APC.
<code>(config-if)# edfa target-outpwr 10</code>	Specify the desired EDFA output power value.

(config-if)#commit	Commit the candidate configuration to the running configuration.
(config-if)#exit	Exit the router mode.

Validation

Verify R1 Router for AGC Mode

```
R1#show running-config interface ce15
!
interface ce15
  edfa operating-mode agc
  edfa target-gain 5.000
!
```

Verify if the gain value is applied after configuring.

```
R1#show interface ce15 transceiver detail
Codes: * Not Qualified By IP Infusion, ** Not Supported By Module, -- No Power, - Not Applicable
```

Intf	DDM	InPwr (dBm)	AlertMax (dBm)	CritMax (dBm)	CritMin (dBm)	AlertMin (dBm)
ce15	Active*	-9.81	+5.00	+4.00	-20.97	-21.94

Intf	DDM	OutPwr (dBm)	AlertMax (dBm)	CritMax (dBm)	CritMin (dBm)	AlertMin (dBm)
ce15	Active*	-4.46	+20.00	+18.00	-10.00	-11.94

Intf	DDM	PumpBias (Amp)	AlertMax (Amp)	CritMax (Amp)	CritMin (Amp)	AlertMin (Amp)
ce15	Active*	+0.05	+0.59	+0.53	+0.00	+0.00

Intf	DDM	Gain (dB)	AlertMax (dB)	CritMax (dB)	CritMin (dB)	AlertMin (dB)
ce15	Active*	+3.67	+26.00	+25.00	+8.00	+7.00

Verify R1 Router for APC Mode

```
R1#show running-config interface ce15
!
interface ce15
  edfa operating-mode apc
  edfa target-outpwr 10.000

R1#show interface ce15 transceiver detail
Codes: * Not Qualified By IP Infusion, ** Not Supported By Module, -- No Power, - Not Applicable
```

Intf	DDM	InPwr (dBm)	AlertMax (dBm)	CritMax (dBm)	CritMin (dBm)	AlertMin (dBm)
ce15	Active*	-9.77	+5.00	+4.00	-20.97	-21.94

Intf	DDM	OutPwr (dBm)	AlertMax (dBm)	CritMax (dBm)	CritMin (dBm)	AlertMin (dBm)
ce15	Active*	+10.08	+20.00	+18.00	-10.00	-11.94

Intf	DDM	PumpBias (Amp)	AlertMax (Amp)	CritMax (Amp)	CritMin (Amp)	AlertMin (Amp)
ce15	Active*	+0.13	+0.59	+0.53	+0.00	+0.00

Intf	DDM	Gain (dB)	AlertMax (dB)	CritMax (dB)	CritMin (dB)	AlertMin (dB)
ce15	Active*	+19.85	+26.00	+25.00	+8.00	+7.00

*NOTE : after unconfiguring the edfa the value of output power and gain should be in default value.
Provide the following:

- o Include a Topology diagram.
- o Document configuration steps. Ensure the topology and configuration steps match.
- o Request a show running-config for the new feature.
- o Provide verification steps to demonstrate that the configuration has taken effect.
- o Add a reference to any relevant information in the existing Configuration Guide.

Note: Request a "test report" before importing QA scenarios into your doc. Ensure you only include configurations samples that "Pass".

EDFA COMMAND REFERENCE

Erbium-doped Fiber Amplifier Commands	1073
edfa operating-mode	1074
edfa target-gain	1075
edfa target-outpwr	1076
show edfa operating-mode	1077
show interface transceiver detail	1078
show interface transceiver threshold violations	1080
show interface transceiver	1081
show interface all transceiver	1083
show interface all transceiver detail	1084
show interface all transceiver threshold violations	1085

Erbium-doped Fiber Amplifier Commands

This chapter is a reference for Erbium-doped fiber amplifier (EDFA) commands:

edfa operating-mode	1074
edfa target-gain	1075
edfa target-outpwr	1076
show edfa operating-mode	1077
show interface transceiver detail	1078
show interface transceiver threshold violations	1080
show interface transceiver	1081
show interface all transceiver	1083
show interface all transceiver detail	1084
show interface all transceiver threshold violations	1085

edfa operating-mode

Use this command to configure EDFA interface operating-mode.

Command Syntax

```
edfa operating-mode (agc | apc)
```

Parameters

agc

Specifies the Automatic Gain Control (AGC) operating-mode.

apc

Specifies the Automatic Power Control (APC) operating-mode.

Default

None

Command Mode

Interface mode

Applicability

Introduced before OcNOS version 6.3.0.

Example

```
OcNOS(config)#interface xe2  
OcNOS(config-if)#edfa operating-mode agc  
OcNOS(config-if)#commit
```

edfa target-gain

Use this command to configure EDFA interface target gain.

Command Syntax

```
edfa target-gain VALUE
```

Parameters

VALUE

Specifies the target gain value.

Default

None

Command Mode

Interface mode

Applicability

Introduced in OcNOS version 6.3.0.

Example

```
OcNOS(config)#interface xe2
OcNOS(config-if)#edfa target-gain 15
OcNOS(config-if)#commit
```

edfa target-outpwr

Use this command to configure EDFA interface target output power.

Command Syntax

```
edfa target-outpwr VALUE
```

Parameters

VALUE

Specifies the target output power value.

Default

None

Command Mode

Interface mode

Applicability

Introduced before OcNOS version 6.3.0.

Example

```
OcNOS(config)#interface xe2
OcNOS(config-if)#edfa target-outpwr 7
OcNOS(config-if)#commit
```

show edfa operating-mode

Use this command to display the EDFA operating-mode summary.

Command Syntax

```
show edfa operating-mode
```

Parameters

None

Default

None

Command Mode

Execution mode and Privileged execution mode

Applicability

Introduced before OcNOS version 6.3.0.

Example

```
OcNOS>show edfa operating-mode

Default Operating Mode      : AGC
Default Target OutPwr (BA) : 17.000
Default Target OutPwr (PA) : 7.000
Default Target Gain        : 17.000

-----
Interface                   Operating-Mode
-----
ce5/1                       AGC
ce7/1                       AGC
cell1/1                     AGC
```

show interface transceiver detail

Use this command to display EDFA attributes and their thresholds from a from a specific port.

Command Syntax

```
show interface IFNAME transceiver detail
```

Parameters

IFNAME

Specifies an interface name.

Default

None

Command Mode

Execution mode and Privileged execution mode

Applicability

Introduced before OcNOS version 6.3.0.

Example

```
OcNOS>show interface ce9/1 transceiver detail
Codes: * Not Qualified By IP Infusion, ** Not Supported By Module, -- No Power, - Not Applicable
...
Intf      DDM      InPwr      AlertMax    CritMax     CritMin     AlertMin
      (dBm)      (dBm)      (dBm)      (dBm)      (dBm)      (dBm)
-----
ce9/1     Inactive* -2.00      -7.00      -9.00      -30.97     -32.22
Intf      DDM      OutPwr      AlertMax    CritMax     CritMin     AlertMin
      (dBm)      (dBm)      (dBm)      (dBm)      (dBm)      (dBm)
-----
ce9/1     Inactive* -7.00      +10.00     +8.00      -20.00     -20.97
Intf      DDM      PumpBias    AlertMax    CritMax     CritMin     AlertMin
      (Amp)      (Amp)      (Amp)      (Amp)      (Amp)      (Amp)
-----
ce9/1     Inactive* +0.35      +0.49      +0.45      +0.00      +0.00
Intf      DDM      Gain        AlertMax    CritMax     CritMin     AlertMin
      (dB)        (dB)        (dB)        (dB)        (dB)        (dB)
-----
ce9/1     Inactive* +12.00     +26.00     +25.00     +8.00      +7.00
```

Here is the explanation of the show command output fields.

Table 73. show interface transceiver details output

Field	Description
Intf	Interface where the EDFA is present.
DDM	Digital diagnostics monitor status for that particular interface.
Inpwr	Input power to the EDFA
OutPwr	Output power from EDFA
PumpBias	Pump Bias
Gain	The total gain over the input power.

show interface transceiver threshold violations

Use this command to display the EDFA module input power, output power, pump bias and gain thresholds violations from a specific port.

Command Syntax

```
show interface IFNAME transceiver threshold violations
```

Parameters

IFNAME

Specifies an interface name.

Default

None

Command Mode

Execution mode and Privileged execution mode

Applicability

Introduced before OcNOS version 6.3.0.

Example

```
OcNOS>show interface cell/1 transceiver threshold violations
Intf      Lane      Timestamp                Type of alarm
----      -
cell/1    1         02-14-2019 12:39:04      Pump Bias low alarm, value 0.000A threshold 0.000A
          02-14-2019 12:38:04      Gain low warning, value 7.500dB threshold 8.000dB
          02-14-2019 12:38:04      Output power low warning, value -11.000dBm threshold -
10.000dBm
          02-14-2019 12:38:04      Input power low warning, value -21.000dBm threshold -
20.969dBm
```

show interface transceiver

Use this command to display the EDFA module input power, output power, pump bias and gain current values from a specific port.

Command Syntax

```
show interface IFNAME transceiver
```

Parameters

IFNAME

Specifies an interface name.

Default

None

Command Mode

Execution mode and Privileged execution mode

Applicability

Introduced before OcNOS version 6.3.0.

Example

```
OcNOS>show interface ce9/1 transceiver
Codes: * Not Qualified By IP Infusion, ** Not Supported By Module, -- No Power, - Not Applicable

Intf      DDM      InPwr      OutPwr      PumpBias      Gain
      (dBm)      (dBm)      (Amp)      (dB)
-----
ce9/1     Inactive* -2.00      -7.00      +0.35      +12.00
OcNOS>show interface ce9/1 transceiver detail
Codes: * Not Qualified By IP Infusion, ** Not Supported By Module, -- No Power, - Not Applicable

...

Intf      DDM      InPwr      AlertMax      CritMax      CritMin      AlertMin
      (dBm)      (dBm)      (dBm)      (dBm)      (dBm)      (dBm)
-----
ce9/1     Inactive* -2.00      -7.00      -9.00      -30.97      -32.22

Intf      DDM      OutPwr      AlertMax      CritMax      CritMin      AlertMin
      (dBm)      (dBm)      (dBm)      (dBm)      (dBm)      (dBm)
-----
ce9/1     Inactive* -7.00      +10.00      +8.00      -20.00      -20.97

Intf      DDM      PumpBias      AlertMax      CritMax      CritMin      AlertMin
      (Amp)      (Amp)      (Amp)      (Amp)      (Amp)      (Amp)
-----
ce9/1     Inactive* +0.35      +0.49      +0.45      +0.00      +0.00

Intf      DDM      Gain      AlertMax      CritMax      CritMin      AlertMin
      (dB)      (dB)      (dB)      (dB)      (dB)      (dB)
-----
ce9/1     Inactive* +12.00     +10.00     +10.00     +10.00     +10.00
```

ce9/1	Inactive*	+12.00	+26.00	+25.00	+8.00	+7.00
-------	-----------	--------	--------	--------	-------	-------

show interface all transceiver

Use this command to display the EDFA module input power, output power, pump bias and gain current values from all ports.

Command Syntax

```
show interface transceiver
```

Parameters

None

Default

None

Command Mode

Execution mode and Privileged execution mode

Applicability

Introduced before OcNOS version 6.3.0.

Example

```
OcNOS>show interface transceiver
Codes:  * Not Qualified By IP Infusion,  ** Not Supported By Module,  -- No Power,  - Not Applicable

Intf      DDM      Temp      Voltage   InPwr     OutPwr     PumpBias   Gain
          (Celsius) (volt)    (dBm)     (dBm)     (Amp)     (dB)
-----
ce0       Inactive* +33.10    +3.28     -8.12     +8.85     +0.11     +16.97
```

show interface all transceiver detail

Use this command to display EDFA module input power, output power, pump bias and gain threshold and current values from all ports.

Command Syntax

```
show interface transceiver detail
```

Parameters

None

Default

None

Command Mode

Execution mode and Privileged execution mode

Applicability

Introduced before OcNOS version 6.3.0.

Example

```
OcNOS>show interface transceiver detail
Codes: * Not Qualified By IP Infusion, ** Not Supported By Module, -- No Power, - Not Applicable
...
Intf      DDM      InPwr      AlertMax    CritMax     CritMin     AlertMin
      (dBm)      (dBm)      (dBm)      (dBm)      (dBm)      (dBm)
-----
ce0      Inactive* -8.12      +5.00      +4.00      -20.97     -21.94
Intf      DDM      OutPwr      AlertMax    CritMax     CritMin     AlertMin
      (dBm)      (dBm)      (dBm)      (dBm)      (dBm)      (dBm)
-----
ce0      Inactive* +8.83      +20.00     +18.00     -10.00     -11.94
Intf      DDM      PumpBias    AlertMax    CritMax     CritMin     AlertMin
      (Amp)      (Amp)      (Amp)      (Amp)      (Amp)      (Amp)
-----
ce0      Inactive* +0.11      +0.59      +0.53      +0.00      +0.00
Intf      DDM      Gain      AlertMax    CritMax     CritMin     AlertMin
      (dB)      (dB)      (dB)      (dB)      (dB)      (dB)
-----
ce0      Inactive* +16.97     +26.00     +25.00     +8.00      +7.00
```

show interface all transceiver threshold violations

Use this command to display the EDFA module input power, output power, pump bias and gain thresholds violations from all ports.

Command Syntax

```
show interface transceiver threshold violations
```

Parameters

None

Default

None

Command Mode

Execution mode and Privileged execution mode

Applicability

Introduced before OcNOS version 6.3.0.

Example

```
OcNOS>show interface transceiver threshold violations
Intf      Lane      Timestamp      Type of alarm
----      -
ce9/1     1         03-05-2019 08:53:31 Gain high alarm, value 100.000dB threshold 26.000dB
          03-05-2019 08:53:31 Pump bias high alarm, value 100.000A threshold 0.579A
          03-05-2019 08:53:31 Output power high alarm, value 100.000dBm threshold
20.000dBm
          03-05-2019 08:53:31 Input power high alarm, value 100.000dBm threshold
5.000dBm
```

NETCONF CONFIGURATION

NetConf Call Home Configuration	1087
User Management VRF Configuration	1087
User Defined VRF Configuration	1088
Start the Call Home Server	1089
NetConf sget Output	1089
Stop the Call Home Server	1089
NetConf Port Access Control	1091
Overview	1091
Feature Characteristics	1091
Benefits	1091
Configuration	1091
Implementation Examples	1104
New CLI Commands	1105
Revised CLI Commands	1113
Abbreviations	1113

NetConf Call Home Configuration

By default, in the NetConf protocol (RFC 6241), a NetConf client application initiates the connection towards the NetConf server in the network element (OcNOS device). However, for certain use cases such as in the presence of firewalls or NAT, it is useful to have “call home” functionality where the connection process is reversed and the NetConf server initiates the connection to the NetConf client. This process, as shown in [Figure 57](#), is standardized by IETF in RFC 8071.

Figure 57. RFC 8071 NetConf call home functionality

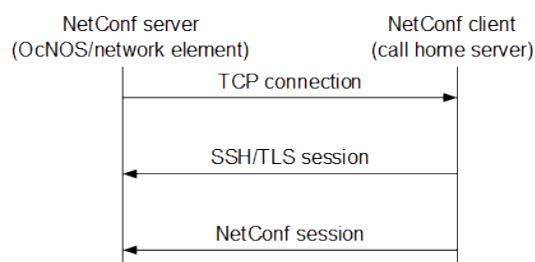

OcNOS supports the call home feature (only for SSH) at the NetConf server side. You can use any standard NetConf client application which supports call home functionality. (Call home support in the NetConf client application [Yangcli] is not supported.)

Call home is generally useful for both the initial deployment and ongoing management of networking elements.

User Management VRF Configuration

<code>(config)#netconf callhome</code>	Enter call home mode
<code>(netconf-callhome)#feature netconf callhome enable</code>	Enable the call home feature
<code>(netconf-callhome)#reconnect enable</code>	Enable the reconnect feature
<code>(netconf-callhome)#retry-max-attempts 10</code>	Set the number of connect retries
<code>(netconf-callhome)#retry-interval 20</code>	Set the retry interval
<code>(netconf-callhome)#callhome server test-ch-server 192.168.56.1</code>	Configure the call home server
<code>(netconf-callhome)#management-port enp0s3</code>	Set the call home management port
<code>(netconf-callhome)#debug callhome</code>	Debugging
<code>(netconf-callhome)#commit</code>	Commit the candidate configuration to the running configuration
<code>(netconf-callhome)#exit</code>	Exit call home mode

Validation

```

(config)#do show running-config netconf-callhome
!
netconf callhome
feature netconf callhome enable
management-port enp0s3
    
```

```

reconnect enable
retry-max-attempts 10
retry-interval 20
callhome server test-ch-server 192.168.56.1
!
(config)#
(config)#do show users
Current user      : (*).  Lock acquired by user : (#).
CLI user         : [C].  Netconf users       : [N].
Location        : Applicable to CLI users.
Session         : Applicable to NETCONF users.

      Line      User      Idle      Location/Session  PID      TYPE      Role
(##) (*) 130 vty 0    [C]root    0d00h00m    pts/0          2730     Local    network-

(config)#
    
```

User Defined VRF Configuration

(netconf-callhome)#feature netconf callhome	Enter callhome feature
(netconf-callhome)#callhome enable vrf user-defined-vrf	Netconf callhome for user defined vrf
(netconf-callhome)#reconnect enable	Enable the reconnect feature
(netconf-callhome)#retry-max-attempts 10	Set the number of connect retries
(netconf-callhome)#retry-interval 20	Set the retry interval
(netconf-callhome)#callhome server test-ch-server 192.168.56.1	Configure the call home server
(netconf-callhome)#debug callhome	Debugging
(netconf-callhome)#exit	Exit call home mode
(netconf-callhome)#commit	Commit the candidate configuration to the running configuration

Validation

```

(config)#do show running-config netconf-callhome
!
netconf callhome
feature netconf callhome enable
management-port enp0s3
reconnect enable
retry-max-attempts 10
retry-interval 20
callhome server test-ch-server 192.168.56.1
!
(config)#
(config)#do show users
Current user      : (*).  Lock acquired by user : (#).
CLI user         : [C].  Netconf users       : [N].
Location        : Applicable to CLI users.
Session         : Applicable to NETCONF users.

      Line      User      Idle      Location/Session  PID      TYPE      Role
(##) (*) 130 vty 0    [C]root    0d00h00m    pts/0          2730     Local    network-

admin
    
```

```
(config)#
```

Start the Call Home Server

After you start the call home server, the **show users** command displays a NetConf user.

```
2022 May 18 15:32:55.989 : OcnOS : CML : INFO : [CML_5]: Client [netconf (192.168.56.1)] established connection with CML server
```

```
(config)#do show users
Current user      : (*). Lock acquired by user : (#).
CLI user         : [C]. Netconf users       : [N].
Location : Applicable to CLI users.
Session  : Applicable to NETCONF users.
```

	Line	User	Idle	Location/Session	PID	TYPE	Role
(#) (*)	130 vty 0	[C]root	0d00h00m	pts/0	2730	Local	network-
	admin						
	NA	[N]root	0d00h00m	192.168.56.1	2118	Local	network-admin

```
(config)#
```

NetConf sget Output

While the NetConf client is running, the **sget** command returns the session-specific data:

```
(config)#do show running-config netconf-callhome
!
netconf callhome
  feature netconf callhome enable
  management-port enp0s3
  reconnect enable
  retry-max-attempts 10
  retry-interval 20
  callhome server test-ch-server 192.168.56.1
!
```

```
(config)#
(config)#do show users
Current user      : (*). Lock acquired by user : (#).
CLI user         : [C]. Netconf users       : [N].
Location : Applicable to CLI users.
Session  : Applicable to NETCONF users.
```

	Line	User	Idle	Location/Session	PID	TYPE	Role
(#) (*)	130 vty 0	[C]root	0d00h00m	pts/0	2730	Local	network-
	admin						

```
(config)#
```

Stop the Call Home Server

After you stop the call home server, the **show users** command no longer displays a NetConf user.

```
2022 May 18 15:33:20.028 : OcnOS : CML : NOTIF : [CML_4]: Client [netconf (192.168.56.1)] has closed connection with CML server
```

```
(config)#
(config)#do show users
```



```
Current user      : (*).  Lock acquired by user : (#).  
CLI user         : [C].  Netconf users       : [N].  
Location : Applicable to CLI users.  
Session  : Applicable to NETCONF users.
```

	Line	User	Idle	Location/Session	PID	TYPE	Role
(#) (*)	130 vty 0	[C]root	0d00h00m	pts/0	2730	Local	network-
admin							

```
(config)#
```

NetConf Port Access Control

Overview

NetConf is a software tool that provides a mechanism to configure and manage remote network devices seamlessly. It uses a simple Remote Procedure Call (RPC) mechanism to facilitate communication between a client and a server.

During the OcNOS installation, the NetConf subsystem called “netconf” is installed. It runs on the default access port 830 over SSH and port 6513 over TLS.

Typically, these default access ports are not configurable and controlled. The NetConf port access control feature enhancement ensures that the Netconf-SSH and NetConf-TLS port access can be controlled and configurable.

Feature Characteristics

- This feature allows access control capabilities for the NetConf-SSH and NetConf-TLS ports.
- Enabling/disabling the port.
- Changing the default port.
- Accessing and controlling the NetConf services through Inband and Outband.
- Applying ACL rules to the NetConf port to control its access.

Benefits

This feature enables the user to control the NetConf port access and change the default port.

Configuration

To configure either NetConf-SSH port or the NetConf-TLS port, perform the following steps. After completing the steps you will be configured with a port for NetConf.

1. Disable `netconf-ssh` and `netconf-tls` feature
2. Configure port for `netconf-ssh` and `netconf-tls`
3. Enable `netconf-ssh` and `netconf-tls` feature

Topology

Figure 58. NetConf Access Port Topology

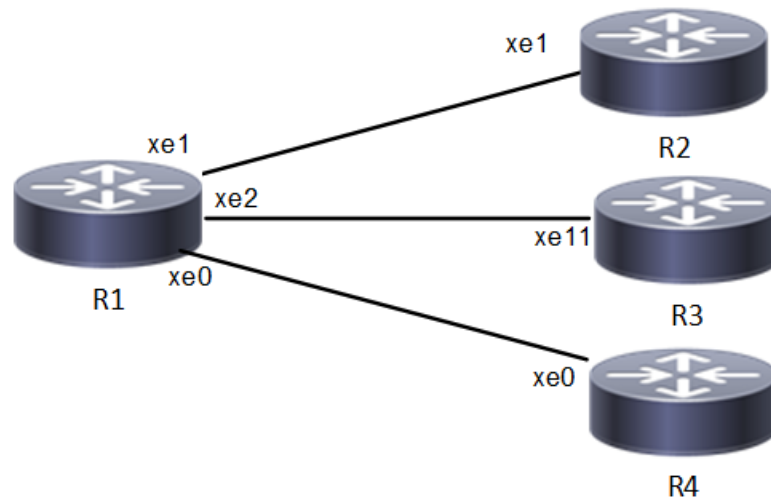

Enable Netconf-ssh on the default and vrf management port

R1

#configure terminal	Enter Configuration mode.
R1(config)#feature netconf-ssh	Enable netconf-ssh via default port.
R1(config)#feature netconf-ssh vrf management	Enable netconf-ssh via vrf management port.
R1(config)#commit	Commit all the transactions.

Enable Netconf-tls on the default and vrf management port

R1

#configure terminal	Enter Configuration mode
R1(config)#feature netconf-tls	Enable netconf-tls via default port
R1(config)#feature netconf-tls vrf management	Enable netconf-tls via vrf management port
R1(config)#commit	Commit all the transactions

Validation

Execute the below commands to verify the NetConf port is enabled on **VRF¹** Management.

Following is the output of the NetConf server status and port.

¹Virtual Routing and Forwarding

```
#show netconf server
VRF Management
  Netconf SSH Server: Enabled
  SSH-Netconf Port : 830
  Netconf TLS Server: Enabled
  TLS-Netconf Port : 6513
VRF Default
  Netconf SSH Server: Enabled
  SSH-Netconf Port : 830
  Netconf TLS Server: Enabled
  TLS-Netconf Port : 6513
```

Following is the output of NetConf server configurations.

```
#show running-config netconf-server
!
feature netconf-ssh vrf management
feature netconf-tls vrf management
netconf server ssh-port 2000 vrf management
netconf server tls-port 60000 vrf management
feature netconf-ssh
feature netconf-tls
netconf server ssh-port 1060
netconf server tls-port 5000
!
```

Following is the output of the NetConf server configuration in XML format.

```
#show xml running-config
<netconf-server xmlns="http://www.ipinfusion.com/yang/ocnos/ipi-management-server">
  <vrfs>
    <vrf>
      <vrf-name>default</vrf-name>
      <config>
        <vrf-name>default</vrf-name>
      </config>
      <netconf-ssh-config>
        <config>
          <feature-netconf-ssh>true</feature-netconf-ssh>
          <ssh-port>1060</ssh-port>
        </config>
      </netconf-ssh-config>
      <netconf-tls-config>
        <config>
          <feature-netconf-tls>true</feature-netconf-tls>
          <tls-port>5000</tls-port>
        </config>
      </netconf-tls-config>
    </vrf>
    <vrf>
      <vrf-name>management</vrf-name>
      <config>
        <vrf-name>management</vrf-name>
      </config>
      <netconf-ssh-config>
        <config>
          <feature-netconf-ssh>true</feature-netconf-ssh>
          <ssh-port>2000</ssh-port>
        </config>
      </netconf-ssh-config>
      <netconf-tls-config>
        <config>
          <feature-netconf-tls>true</feature-netconf-tls>
          <tls-port>60000</tls-port>
        </config>
      </netconf-tls-config>
    </vrf>
  </vrfs>
</netconf-server>
```

```

    </netconf-tls-config>
  </vrf>
</vrfs>
</netconf-server>
<network-instances xmlns="http://www.ipinfusion.com/yang/ocnos/ipi-network-insta
nce">
  <network-instance>
    <instance-name>default</instance-name>
    <instance-type>vrf</instance-type>
    <config>
      <instance-name>default</instance-name>
      <instance-type>vrf</instance-type>
    </config>
    <vrf xmlns="http://www.ipinfusion.com/yang/ocnos/ipi-vrf">
      <config>
        <vrf-name>default</vrf-name>
      </config>
    </vrf>
  </network-instance>
  <network-instance>
    <instance-name>management</instance-name>
    <instance-type>vrf</instance-type>
    <config>
      <instance-name>management</instance-name>
      <instance-type>vrf</instance-type>
    </config>
    <vrf xmlns="http://www.ipinfusion.com/yang/ocnos/ipi-vrf">
      <config>
        <vrf-name>management</vrf-name>
      </config>
    </vrf>
  </network-instance>
</network-instances>
<interfaces xmlns="http://www.ipinfusion.com/yang/ocnos/ipi-interface">

```

Following is the output after login to the NetConf interface (YangCLI) on R1 node via the default NetConf port:

```

root@OcnOS:~# ip netns exec zebosfib0 yangcli --server=127.1 --user=ocnos --password=ocnos
yangcli version 2.5-5
libssh2 version 1.8.0

Copyright (c) 2008-2012, Andy Bierman, All Rights Reserved.
Copyright (c) 2013-2015, Vladimir Vassilev, All Rights Reserved.
Copyright (c) 2012-2016, OpenClovis Inc, All Rights Reserved.

Type 'help' or 'help <command-name>' to get started
Use the <tab> key for command and value completion
Use the <enter> key to accept the default value in brackets

These escape sequences are available when filling parameter values:

?      help
??     full help
?s     skip current parameter
?c     cancel current command

These assignment statements are available when entering commands:

$<varname> = <expr>      Local user variable assignment
$$<varname> = <expr>    Global user variable assignment
@<filespec> = <expr>    File assignment
val->res is NO_ERR.

yangcli: Starting NETCONF session for ocnos on 127.1

NETCONF session established for ocnos on 127.1
.....

```

Disable netconf-ssh via default and vrf management port

R1

#configure terminal	Enter Configuration mode
R1(config)#no feature netconf-ssh	Disable netconf-ssh via default port
R1(config)#no feature netconf-ssh vrf management	Disable netconf-ssh via vrf management
R1(config)#commit	Commit all the transactions

Disable netconf-tls via default port and vrf management port

R1

#configure terminal	Enter Configuration mode
R1(config)#no feature netconf-tls	Disable netconf-tls via default
R1(config)#no feature netconf-tls vrf management	Disable netconf-tls via vrf management port
R1(config)#commit	Commit all the transactions

Validation

Execute the below commands to verify the NetConf port is disabled on VRF Management.

Following is the output of the NetConf server status and port.

```
#show netconf server
VRF Management
    Netconf Server: Disabled
VRF Default
    Netconf Server: Disabled
```

Configuring NetConf Port

R1

#configure terminal	Enter Configuration mode
R1(config)#no feature netconf-ssh	Disable netconf-ssh via default port
R1(config)#no feature netconf-ssh vrf management	Disable netconf-ssh via vrf management port
R1(config)#no feature netconf-tls	Disable netconf-tls via default port
R1(config)#no feature netconf-tls vrf management	Disable netconf-tls via vrf management port
R1(config)#commit	Commit all the transactions
#configure terminal	Enter Configuration mode
R1(config)#netconf server ssh-port 1060	Configure port for netconf-ssh default
R1(config)#netconf server ssh-port 2000 vrf management	Configure port for netconf-ssh vrf management

R1(config)#netconf server tls-port 5000	Configure port for netconf-tls default
R1(config)#netconf server tls-port 60000 vrf management	Configure port for netconf-tls vrf management
R1(config)#commit	Commit all the transactions
#configure terminal	Enter Configuration mode
R1(config)#feature netconf-ssh	Enable netconf-ssh via default port
R1(config)#feature netconf-ssh vrf management	Enable netconf-ssh via vrf management port
R1(config)#feature netconf-tls	Enable netconf-tls via default port
R1(config)#feature netconf-tls vrf management	Enable netconf-tls via vrf management port
R1(config)#commit	Commit all the transactions

Validation

Following is the output of the NetConf server status and port.

```
#show netconf server
VRF Management
  Netconf SSH Server: Enabled
  SSH-Netconf Port : 2000
  Netconf TLS Server: Enabled
  TLS-Netconf Port : 60000
VRF Default
  Netconf SSH Server: Enabled
  SSH-Netconf Port : 1060
  Netconf TLS Server: Enabled
  TLS-Netconf Port : 5000
```

Following is the output after login to the NetConf interface (YangCLI) on R1 node via the user defined NetConf port:

```
root@OcNOS:~# ip netns exec zebosfib1 yangcli --server=127.1 --user=ocnos --password=ocnos
ncport=2000
Warning: Revision date in the future (2022-08-30), further warnings are suppressed
ietf-netconf-notifications.yang:46.4: warning(421): revision date in the future

yangcli version 2.5-5
libssh2 version 1.8.0

Copyright (c) 2008-2012, Andy Bierman, All Rights Reserved.
Copyright (c) 2013-2015, Vladimir Vassilev, All Rights Reserved.
Copyright (c) 2012-2016, OpenClovis Inc, All Rights Reserved.

Type 'help' or 'help <command-name>' to get started
Use the <tab> key for command and value completion
Use the <enter> key to accept the default value in brackets

These escape sequences are available when filling parameter values:

?      help
??     full help
?s     skip current parameter
?c     cancel current command

These assignment statements are available when entering commands:

$<varname> = <expr>      Local user variable assignment
$$<varname> = <expr>     Global user variable assignment
@<filespec> = <expr>     File assignment
val->res is NO_ERR.
```

```

yangcli: Starting NETCONF session for ocnos on 127.1

NETCONF session established for ocnos on 127.1
.....
Checking Server Modules...

yangcli ocnos@127.1>

```

Ping between two nodes via Yang CLI

Perform the following configurations to verify the reachability among R1, R2 and R3 routers via NetConf-SSH and NetConf-TLS port.

R1

#configure terminal	Enter Configuration mode
R1(config)#no feature netconf-ssh	Disable netconf-ssh via default
R1(config)#no feature netconf-ssh vrf management	Disable netconf-ssh via vrf management port
R1(config)#no feature netconf-tls	Disable netconf-tls via default port
R1(config)#no feature netconf-tls vrf management	Disable netconf-tls via vrf management port
R1(config)#commit	Commit all the transactions
#configure terminal	Enter Configuration mode
R1(config)#netconf server ssh-port 1060	Configure port for netconf-ssh default
R1(config)#netconf server ssh-port 2000 vrf management	Configure port for netconf-ssh vrf management
R1(config)#netconf server tls-port 5000	Configure port for netconf-tls default
R1(config)#netconf server tls-port 60000 vrf management	Configure port for netconf-tls vrf management
R1(config)#commit	Commit all the transactions
#configure terminal	Enter Configuration mode
R1(config)#feature netconf-ssh	Enable netconf-ssh via default port
R1(config)#feature netconf-ssh vrf management	Enable netconf-ssh via vrf management port
R1(config)#feature netconf-tls	Enable netconf-tls via default port
R1(config)#feature netconf-tls vrf management	Enable netconf-tls via vrf management port
R1(config)#commit	Commit all the transactions
#configure terminal	Enter Configuration mode
R1(config)#interface xe1	Enter interface mode
R1(config)#ip address 10.10.10.1/24	Configure ipv4 address on the interface xe1.
R1(config)#commit	Commit all the transactions

R2

#configure terminal	Enter Configuration mode
R2(config)#no feature netconf-ssh	Disable netconf-ssh via default
R2(config)#no feature netconf-ssh vrf management	Disable netconf-ssh via vrf management
R2(config)#no feature netconf-tls	Disable netconf-tls via default
R2(config)#no feature netconf-tls vrf management	Disable netconf-tls via vrf management port
R2(config)#commit	Commit all the transactions
#configure terminal	Enter Configuration mode
R2(config)#netconf server ssh-port 1060	Configure port for netconf-ssh default
R2(config)#netconf server ssh-port 2000 vrf management	Configure port for netconf-ssh vrf management
R2(config)#netconf server tls-port 5000	Configure port for netconf-tls default
R2(config)#netconf server tls-port 60000 vrf management	Configure port for netconf-tls vrf management
R2(config)#commit	Commit all the transactions
#configure terminal	Enter Configuration mode
R2(config)#feature netconf-ssh	Enable netconf-ssh via default port
R2(config)#feature netconf-ssh vrf management	Enable netconf-ssh via vrf management port
R2(config)#feature netconf-tls	Enable netconf-tls via default port
R2(config)#feature netconf-tls vrf management	Enable netconf-tls via vrf management port
R2(config)#commit	Commit all the transactions
#configure terminal	Enter Configuration mode
R2(config)#interface xe1	Enter interface mode
R2(config)#ip address 10.10.10.2/24	Configure ipv4 address on the interface xe1.
R2(config)#commit	Commit all the transactions

Validation

Following is the output of the configured NetConf port.

```
#show netconf server
VRF Management
  Netconf SSH Server: Enabled
  SSH-Netconf Port : 2000
  Netconf TLS Server: Enabled
  TLS-Netconf Port : 60000
VRF Default
  Netconf SSH Server: Enabled
  SSH-Netconf Port : 1060
  Netconf TLS Server: Enabled
  TLS-Netconf Port : 5000

OcnOS#show running-config interface xe1
```

```

!
interface xe1
 ip address 10.10.10.1/24
!
OcnOS#ping 10.10.10.2
Press CTRL+C to exit
PING 10.10.10.2 (10.10.10.2) 56(84) bytes of data.
64 bytes from 10.10.10.2: icmp_seq=1 ttl=64 time=0.567 ms
64 bytes from 10.10.10.2: icmp_seq=2 ttl=64 time=0.258 ms
64 bytes from 10.10.10.2: icmp_seq=3 ttl=64 time=0.241 ms

--- 10.10.10.2 ping statistics ---
3 packets transmitted, 3 received, 0% packet loss, time 80ms
rtt min/avg/max/mdev = 0.241/0.355/0.567/0.150 ms

```

Following is the output after login to the NetConf interface (YangCLI) on R2 node through the user defined NetConf port:

```

root@OcnOS:~# ip netns exec zebosfib0 yangcli --server=10.10.10.2 --user=ocnos --password=ocnos
ncport=1060
Warning: Revision date in the future (2022-08-30), further warnings are suppressed
ietf-netconf-notifications.yang:46.4: warning(421): revision date in the future

yangcli version 2.5-5
libssh2 version 1.8.0

Copyright (c) 2008-2012, Andy Bierman, All Rights Reserved.
Copyright (c) 2013-2015, Vladimir Vassilev, All Rights Reserved.
Copyright (c) 2012-2016, OpenClovis Inc, All Rights Reserved.

Type 'help' or 'help <command-name>' to get started
Use the <tab> key for command and value completion
Use the <enter> key to accept the default value in brackets

These escape sequences are available when filling parameter values:

?      help
??     full help
?s     skip current parameter
?c     cancel current command

These assignment statements are available when entering commands:

$<varname> = <expr>      Local user variable assignment
$$<varname> = <expr>    Global user variable assignment
@<filespec> = <expr>    File assignment
val->res is NO_ERR.

yangcli: Starting NETCONF session for ocnos on 10.10.10.2

NETCONF session established for ocnos on 10.10.10.2
.....
Checking Server Modules...

yangcli ocnos@10.10.10.2>

```

ACL Rule with IPv4 Configuration

Perform the following configurations to apply an ACL rule to allow or deny traffic from R1 to other nodes via NetConf port.

R1

#configure terminal	Enter Configuration mode
R1(config)#no feature netconf-ssh	Disable netconf-ssh via default
R1(config)#no feature netconf-ssh vrf management	Disable netconf-ssh via vrf management port
R1(config)#no feature netconf-tls	Disable netconf-tls via default port
R1(config)#no feature netconf-tls vrf management	Disable netconf-tls via vrf management port
R1(config)#commit	Commit all the transactions
#configure terminal	Enter Configuration mode
R1(config)#netconf server ssh-port 1060	Configure port for netconf-ssh default
R1(config)#netconf server ssh-port 2000 vrf management	Configure port for netconf-ssh vrf management
R1(config)#netconf server tls-port 5000	Configure port for netconf-tls default
R1(config)#netconf server tls-port 60000 vrf management	Configure port for netconf-tls vrf management
R1(config)#commit	Commit all the transactions
#configure terminal	Enter Configuration mode
R1(config)#feature netconf-ssh	Enable netconf-ssh via default port
R1(config)#feature netconf-ssh vrf management	Enable netconf-ssh via vrf management port
R1(config)#feature netconf-tls	Enable netconf-tls via default port
R1(config)#feature netconf-tls vrf management	Enable netconf-tls via vrf management port
R1(config)#commit	Commit all the transactions
#configure terminal	Enter Configuration mode
R1(config)#interface xe1	Enter interface mode
R1(config)#ip address 10.10.10.1/24	Configure ipv4 address on the interface xe1.
R1(config)#commit	Commit all the transactions
#configure terminal	Enter Configuration mode
R1(config)#interface xe2	Enter interface mode
R1(config)#ip address 20.20.20.1/24	Configure ipv4 address on the interface xe2.
R1(config)#commit	Commit all the transactions
#configure terminal	Enter Configuration mode
R1(config)#ip access-list ACL1	Create ip access list
R1(config)#permit any host 10.1.1.1 any	Create an acl rule to permit
R1(config)#deny any host 20.1.1.1 any	Create an acl rule to deny
R1(config)#commit	Commit all the transactions

R2

Perform the following configurations to apply an ACL rule to allow or deny traffic from R2 to other nodes via NetConf port

#configure terminal	Enter Configuration mode
R2(config)#no feature netconf-ssh	Disable netconf-ssh via default
R2(config)#no feature netconf-ssh vrf management	Disable netconf-ssh via vrf management
R2(config)#no feature netconf-tls	Disable netconf-tls via default
R2(config)#no feature netconf-tls vrf management	Disable netconf-tls via vrf management port
R2(config)#commit	Commit all the transactions
#configure terminal	Enter Configuration mode
R2(config)#netconf server ssh-port 1060	Configure port for netconf-ssh default
R2(config)#netconf server ssh-port 2000 vrf management	Configure port for netconf-ssh vrf management
R2(config)#netconf server tls-port 5000	Configure port for netconf-tls default
R2(config)#netconf server tls-port 60000 vrf management	Configure port for netconf-tls vrf management
R2(config)#commit	Commit all the transactions
#configure terminal	Enter Configuration mode
R2(config)#feature netconf-ssh	Enable netconf-ssh via default port
R2(config)#feature netconf-ssh vrf management	Enable netconf-ssh via vrf management port
R2(config)#feature netconf-tls	Enable netconf-tls via default port
R2(config)#feature netconf-tls vrf management	Enable netconf-tls via vrf management port
R2(config)#commit	Commit all the transactions
#configure terminal	Enter Configuration mode
R2(config)#interface xe1	Enter interface mode
R2(config)#ip address 10.10.10.2/24	Configure ipv4 address on the interface xe1.
R2(config)#commit	Commit all the transactions

R3

Perform the following configurations to apply an ACL rule to allow or deny traffic from R3 to other nodes via NetConf port.

#configure terminal	Enter Configuration mode
R3(config)#no feature netconf-ssh	Disable netconf-ssh via default
R3(config)#no feature netconf-ssh vrf management	Disable netconf-ssh via vrf management port

R3(config)#no feature netconf-tls	Disable netconf-tls via default port
R3(config)#no feature netconf-tls vrf management	Disable netconf-tls via vrf management port
R3(config)#commit	Commit all the transactions
#configure terminal	Enter Configuration mode
R3(config)#netconf server ssh-port 1060	Configure port for netconf-ssh default
R3(config)#netconf server ssh-port 2000 vrf management	Configure port for netconf-ssh vrf management
R3(config)#netconf server tls-port 5000	Configure port for netconf-tls default
R3(config)#netconf server tls-port 60000 vrf management	Configure port for netconf-tls vrf management
R3(config)#commit	Commit all the transactions
#configure terminal	Enter Configuration mode
R3(config)#feature netconf-ssh	Enable netconf-ssh via default port
R3(config)#feature netconf-ssh vrf management	Enable netconf-ssh via vrf management port
R3(config)#feature netconf-tls	Enable netconf-tls via default port
R3(config)#feature netconf-tls vrf management	Enable netconf-tls via vrf management port
R3(config)#commit	Commit all the transactions
#configure terminal	Enter Configuration mode
R3(config)#interface xe11	Enter interface mode
R3(config)#ip address 20.20.20.2/24	Configure ipv4 address on the interface xe11.
R3(config)#commit	Commit all the transactions

Validation

Following is the output to verify the user defined NetConf port.

```
R1#show running-config netconf-server
!
feature netconf-ssh vrf management
feature netconf-tls vrf management
netconf server ssh-port 2000 vrf management
netconf server tls-port 60000 vrf management
feature netconf-ssh
feature netconf-tls
netconf server ssh-port 1060
netconf server tls-port 5000
!

R1#show netconf server
VRF Management
  Netconf SSH Server: Enabled
  SSH-Netconf Port : 2000
  Netconf TLS Server: Enabled
  TLS-Netconf Port : 60000
VRF Default
  Netconf SSH Server: Enabled
  SSH-Netconf Port : 1060
  Netconf TLS Server: Enabled
  TLS-Netconf Port : 5000
```

Following is the output of the show running-config in XML format.

```
R1#show xml running-config
<netconf-server xmlns="http://www.ipinfusion.com/yang/ocnos/ipi-management-serve
r">
  <vrfs>
    <vrf>
      <vrf-name>default</vrf-name>
      <config>
        <vrf-name>default</vrf-name>
      </config>
      <netconf-ssh-config>
        <config>
          <feature-netconf-ssh>true</feature-netconf-ssh>
          <ssh-port>1060</ssh-port>
        </config>
      </netconf-ssh-config>
      <netconf-tls-config>
        <config>
          <feature-netconf-tls>true</feature-netconf-tls>
          <tls-port>5000</tls-port>
        </config>
      </netconf-tls-config>
    </vrf>
    <vrf>
      <vrf-name>management</vrf-name>
      <config>
        <vrf-name>management</vrf-name>
      </config>
      <netconf-ssh-config>
        <config>
          <feature-netconf-ssh>true</feature-netconf-ssh>
          <ssh-port>2000</ssh-port>
        </config>
      </netconf-ssh-config>
      <netconf-tls-config>
        <config>
          <feature-netconf-tls>true</feature-netconf-tls>
          <tls-port>60000</tls-port>
        </config>
      </netconf-tls-config>
    </vrf>
  </vrfs>
</netconf-server>
<network-instances xmlns="http://www.ipinfusion.com/yang/ocnos/ipi-network-insta
nce">
  <network-instance>
    <instance-name>default</instance-name>
    <instance-type>vrf</instance-type>
    <config>
      <instance-name>default</instance-name>
      <instance-type>vrf</instance-type>
    </config>
    <vrf xmlns="http://www.ipinfusion.com/yang/ocnos/ipi-vrf">
      <config>
        <vrf-name>default</vrf-name>
      </config>
    </vrf>
  </network-instance>
  <network-instance>
    <instance-name>management</instance-name>
    <instance-type>vrf</instance-type>
    <config>
      <instance-name>management</instance-name>
      <instance-type>vrf</instance-type>
    </config>
    <vrf xmlns="http://www.ipinfusion.com/yang/ocnos/ipi-vrf">
      <config>
        <vrf-name>management</vrf-name>
      </config>
    </vrf>
  </network-instance>
</network-instances>
```

```

    </config>
  </vrf>
</network-instance>
</network-instances>
<interfaces xmlns="http://www.ipinfusion.com/yang/ocnos/ipi-interface">

```

Implementation Examples

The below examples are based on the topology given in Topology section.

Accessing R1 from R2 with default port

Below is an example to access R1 from R2 with default port.

From OcNOS CLI:

```

feature netconf-ssh
feature netconf-ssh vrf management
feature netconf-tls
feature netconf-tls vrf management

```

From Yang CLI:

```

root@OcNOS:~# ip netns exec zebosfib0 yangcli --server=127.1 --user=ocnos --password=ocnos

```

Accessing R1 from R2 with user defined port

Below is an example to access R1 from R2 via user defined port.

From OcNOS CLI:

```

netconf server ssh-port 1060
netconf server ssh-port 2000 vrf management
netconf server tls-port 5000
netconf server tls-port 60000 vrf management

```

From Yang CLI:

```

root@OcNOS:~# ip netns exec zebosfib1 yangcli --server=10.10.10.1 --user=ocnos --password=ocnos
ncport=2000

```

Applying ACL rule to permit or deny any Node

Below is an example to permit any traffic originating from IP address 10.1.1.1. and deny any traffic originating from 20.1.1.1.

From OcNOS CLI:

```

ip access-list ACL1
permit any host 10.1.1.1 any
deny any host 20.1.1.1 any
Permitting R2 and denying R3

```

From Yang CLI:

```

root@OcNOS:~# ip netns exec zebosfib1 yangcli --server=10.10.10.2 --user=ocnos -- password=ocnos
ncport=2000

```

New CLI Commands

feature netconf-ssh	1106
feature netconf-tls	1107
netconf-ssh port	1109
netconf-tls port	1110
show netconf server	1111
show running-config netconf server	1112

feature netconf-ssh

Use this command to enable or disable the netconf-ssh feature specific to the management **VRF**¹. When netconf feature-ssh is enabled, it allows the logins through the default netconf-ssh port or through default ssh port if feature SSH is also enabled.

Command Syntax

```
feature netconf-ssh (vrf management|)
no feature netconf-ssh (vrf management|)
```

Parameters

vrf management

Specifies the management Virtual Routing and Forwarding

Default

Disabled by default.

Command Mode

Configure mode

Applicability

This command was introduced in OcNOS version 6.4.1.

Examples

The following example shows you how to enable NetConf SSH on either the VRF management port or the default port. The no parameter disables the same.

```
(config)#feature netconf-ssh vrf management
(config)#feature netconf-ssh
(config)#no feature netconf-ssh vrf management
(config)#no feature netconf-ssh
#
```

¹Virtual Routing and Forwarding

feature netconf-tls

Use this command to enable or disable the NetConf TLS feature specific to a **VRF**¹. When netconf feature-ssh is enabled, it allows the logins through the default netconf-tls port and allows login through a default TLS port when the TLS feature is also enabled.

Command Syntax

```
feature netconf-tls (vrf management|)
no feature netconf-tls (vrf management|)
```

Parameters

vrf management

Specifies management Virtual Routing and Forwarding.

Default

Disabled by default.

Command Mode

Configure mode

Applicability

This command was introduced in OcNOS version 6.4.1.

Examples

The following example shows how to execute the CLI:

```
(config)#feature netconf-tls vrf management
(config)#feature netconf-tls
(config)#no feature netconf-tls vrf management
(config)#no feature netconf-tls
```

If either NetConf SSH or NetConf TLS are disabled one after the other, the following error message will be displayed, **% Disabling this will stop the netconf service that is running in management vrf**” as shown below.

Management VRF Configuration

```
OcNOS#configure terminal
Enter configuration commands, one per line. End with CNTL/Z.
(config)#no feature netconf-ssh vrf management
(config)#commit
(config)#no feature netconf-tls vrf management
(config)#commit
% Disabling this will stop the netconf service that is running in management vrf.
```

Default VRF Configuration

```
OcNOS#configure terminal
Enter configuration commands, one per line. End with CNTL/Z.
(config)#no feature netconf-ssh vrf management
(config)#commit
```

¹Virtual Routing and Forwarding

```
(config)#no feature netconf-tls vrf management
(config)#commit
% Disabling this will stop the netconf service that is running in default vrf.
```

netconf-ssh port

Use this command to either configure or unconfigure the custom NetConf SSH port.

Command Syntax

```
netconf-server ssh-port <1024-65535> (vrf management|)  
no netconf-server ssh-port (vrf management|)
```

Parameters

<1024-65535>

Port range values

Default

By default, the netconf-ssh port value is 830.

vrf

Specifies the management Virtual Routing and Forwarding name

Command Mode

Configure mode

Applicability

This command was introduced in OcNOS version 6.4.1.

Examples

The following example shows how to execute the CLI:

```
(config)#netconf server ssh-port ?  
  <1024-65535> port  
(config)#netconf server ssh-port 1024 vrf management  
(config)#netconf server ssh-port 2000  
(config)#no netconf server ssh-port  
(config)#no netconf server ssh-port vrf management
```

netconf-tls port

Use this command to either configure or unconfigure the indicated NetConf TLS port.

Command Syntax

```
netconf-server tls-port <1024-65535> (vrf management|)
no netconf-server tls-port (vrf management|)
```

Parameters

<1024-65535>

Port range values

Default

By default, the netconf-tls port value is 6513.

vrf

Specifies the management Virtual Routing and Forwarding name

Command Mode

Configure mode

Applicability

This command was introduced in OcNOS version 6.4.1.

Examples

```
(config)#netconf server tls-port ?
<1024-65535> port
(config)#netconf server tls-port 5000 vrf management
(config)#netconf server tls-port 3000
(config)#no netconf server tls-port vrf management
(config)#no netconf server tls-port
```

show netconf server

Use this command to display netconf server status.

Command Syntax

```
show netconf server
```

Parameters

None

Command Mode

Execution mode

Applicability

This command was introduced before OcNOS version 6.4.1.

Examples

The following example shows the output of the CLI:

```
OcNOS#show netconf server
VRF MANAGEMENT
Netconf Server: Enabled
SSH-Netconf Port : 1000
TLS-Netconf Port : 7000
VRF DEFAULT
Netconf Server: Enabled
SSH-Netconf Port : 4500
TLS-Netconf Port : 3000
```

show running-config netconf server

Use this command to display the NetConf server settings that appear in the running configuration.

Command Syntax

```
show running-config netconf-server
```

Parameters

None

Command Mode

Execution mode

Applicability

This command was introduced in OcNOS version 6.4.1.

Examples

The following example shows the output of the CLI:

```
OcNOS#show running-config netconf-server
feature netconf vrf management
netconf server ssh-port 1000 vrf management
netconf server tls-port 7000 vrf management
feature netconf
netconf server ssh-port 4500
netconf server tls-port 3000
!
```

Revised CLI Commands

ip access-list tcp|udp

The existing `ip access-list tcp|udp` CLI is updated with the following two options to support the Access List (ACL) rules on the NetConf port. The ACL defines a set of rules to control network traffic and reduce network attacks.

netconf-ssh

Secure Shell Network Configuration

netconf-tls

Transport Layer Security Network Configuration

For the complete command reference, refer to [ip access-list tcp|udp \(page 1266\)](#) CLI in [Access Control List Commands \(XGS\)](#) section.

Abbreviations

The following are some key abbreviations and their meanings relevant to this document:

Acronym	Description
ACL	Access control list
RPC	Remote Procedure Call
SSH	Secure Shell
TLS	Transport Layer Security

NETCONF COMMAND REFERENCE

NetConf Call Home Commands	1115
callhome server	1116
debug callhome	1118
feature netconf callhome	1120
management-port	1122
netconf callhome	1124
reconnect	1125
retry-interval	1127
retry-max-attempts	1129
show (xml) running-config netconf-callhome	1131

NetConf Call Home Commands

This chapter describes these commands:

callhome server	1116
debug callhome	1118
feature netconf callhome	1120
management-port	1122
netconf callhome	1124
reconnect	1125
retry-interval	1127
retry-max-attempts	1129
show (xml) running-config netconf-callhome	1131

callhome server

Use this command to add a call home server. A maximum 5 servers can be configured.

Use the `no` form of this command to delete a call home server. If the specified call home server is already connected with the OcNOS NetConf server, deleting it will not disconnect it.

Command Syntax

```
callhome server WORD (A.B.C.D|X:X::X:X|HOSTNAME)
callhome server WORD (A.B.C.D|X:X::X:X|HOSTNAME) port <1-65535>
no callhome server WORD
```

Parameters

WORD

An arbitrary name for the NetConf listen endpoint. Any valid string with length 1-64 can be used.

A.B.C.D

IPv4 address of the call home server

X:X::X:X

IPv4 address of the call home server

HOSTNAME

Host name of the call home server

<1-65535>

Callhome server listening port



Notes: The same address can be configured with different endpoint names, so use a different port number in those cases. For example:

```
callhome server name-1 1.1.1.1
callhome server name-3 1.1.1.1 port 5555
```

Avoid the redundant configuration: `callhome server name-2 1.1.1.1`

Default

Default value for the port is IANA assigned port 4334.

Command Mode

NetConf call home mode

Applicability

This command was introduced in OcNOS version 6.0.0.

Example

The below configuration example illustrates how to define and manage callhome servers for NetConf communication.

1. Check the existing NetConf Callhome configuration using the **show running-config netconf-callhome** command.

```
(config)#netconf callhome
(netconf-callhome)#do show running-config netconf-callhome
!
netconf callhome
  feature netconf callhome enable
!
```

2. Configure the Callhome server.

```
(netconf-callhome)#callhome server name-1 169.154.45.12
(netconf-callhome)#callhome server name-2 192.168.56.1 port 12234
(netconf-callhome)#commit
```

3. Check the current NetConf Callhome configurations using the **show running-config netconf-callhome** command.

```
(netconf-callhome)#do show running-config netconf-callhome
!
netconf callhome
  feature netconf callhome enable
  callhome server name-1 169.154.45.12
  callhome server name-2 192.168.56.1 port 12234
!
```

4. Remove the configured **name-2** Callhome server.

```
(netconf-callhome)#no callhome server name-2
(netconf-callhome)#commit
```

5. Check the current NetConf Callhome configurations using the **show running-config netconf-callhome** command.

```
(netconf-callhome)#do show running-config netconf-callhome
!
netconf callhome
  feature netconf callhome enable
  callhome server name-1 169.154.45.12
!
(netconf-callhome)#exit
```

debug callhome

Use this command to enable debugging for the call home module. Once enabled, all debugging related information will be logged in the system logger file.

Use the **no** form of this command to disable debugging for the call home module.

Command Syntax

```
debug callhome
no debug callhome
```

Parameters

None

Default

By default, debugging is disabled (only critical message are enabled).

Command Mode

NetConf call home mode

Applicability

This command was introduced in OcNOS version 6.0.0.

Example

The below configuration example illustrates how to enable or disable debugging for the Callhome module.

1. Check the existing NetConf Callhome configuration using the **show running-config netconf-callhome** command.

```
(config)#netconf callhome
(netconf-callhome)#do show running-config netconf-callhome
!
netconf callhome
!
```

2. Enable debug command for the Callhome module.

```
(netconf-callhome)#debug callhome
(netconf-callhome)#commit
```

3. Check the current NetConf Callhome configurations using the **show running-config netconf-callhome** command.

```
(netconf-callhome)#do show running-config netconf-callhome
!
netconf callhome
  debug callhome
!
```

4. Remove the configured debug command to disable debugging for the call home module.

```
(netconf-callhome)#no debug callhome  
(netconf-callhome)#commit
```

5. Check the current NetConf Callhome configurations using the **show running-config netconf-callhome** command.

```
(netconf-callhome)#do show running-config netconf-callhome  
!  
netconf callhome  
!  
  
(netconf-callhome)#exit
```

feature netconf callhome

Use this command to enable or disable the NetConf call home feature. When the feature is disabled, all other configurations are removed except [debug callhome \(page 1118\)](#).

Enabling the call home feature is required before doing any other call home configurations.

Command Syntax

```
feature netconf callhome (enable|disable)
```

Parameters

enable

Enable the call home feature

disable

Disable the call home feature

Default

By default, the call home feature is disabled.

Mode

NetConf call home mode

Applicability

This command was introduced in OcNOS version 6.0.0.

Example

The below configuration example illustrates how to enable or disable the NetConf Callhome feature.

1. Check the existing NetConf Callhome configuration using the **show running-config netconf-callhome** command.

```
(config)#do show running-config netconf-callhome
(config)#
```

2. Enable the NetConf Callhome feature.

```
(config)#netconf callhome
(netconf-callhome)#feature netconf callhome enable
(netconf-callhome)#commit
```

3. Check the current NetConf Callhome configurations using the **show running-config netconf-callhome** command.

```
(netconf-callhome)#do show running-config netconf-callhome
!
netconf callhome
  feature netconf callhome enable
!
```

4. Disable the NetConf callhome feature.

```
(netconf-callhome)#feature netconf callhome disable
(netconf-callhome)#commit
```

5. Check the current NetConf Callhome configurations using the **show running-config netconf-callhome** command.

```
(netconf-callhome)#do show running-config netconf-callhome
!  
netconf callhome  
!  
(netconf-callhome)#exit
```

management-port

Use this command to add an interface to use to connect to a call home server. This is useful when in-band (front panel) ports are used as management ports.

Use the **no** form of this command to use eth0 as the management port.

Command Syntax

```
management-port IFNAME
no management-port
```

Parameters

IFNAME

Interface used to connect to the call home server.

Default

By default, eth0 (out-of-band management port) is used as the management port.

Command Mode

NetConf call home mode

Applicability

This command was introduced in OcNOS version 6.0.0.

Example

The below configuration example illustrates how to enable or disable the NetConf Callhome feature.

1. Check the existing NetConf Callhome configuration using the **show running-config netconf-callhome** command.

```
(netconf-callhome)#do show running-config netconf-callhome
!
netconf callhome
  feature netconf callhome enable
!
```

2. Using the management port command, add an interface **xe4** to connect to the call home server.

```
(netconf-callhome)#management-port xe4
(netconf-callhome)#commit
```

3. Check the current NetConf Callhome configuration using the **show running-config netconf-callhome** command.

```
(netconf-callhome)#do show running-config netconf-callhome
!
netconf callhome
  feature netconf callhome enable
  management-port xe4
!
```

4. Remove the connected interface **xe4** using the **no** command, and by default, **eth0** is used as the management port.

```
(netconf-callhome)#no management-port
(netconf-callhome)#commit
```

5. Check the current NetConf Callhome configuration using the **show running-config netconf-callhome** command.

```
(netconf-callhome)#do show running-config netconf-callhome
!
netconf callhome
  feature netconf callhome enable
!
(netconf-callhome)#exit
```

netconf callhome

Use this command to enter NetConf call home configuration mode. All call home configurations are done in this mode.

Command Syntax

```
netconf callhome
```

Command Mode

Configure mode

Applicability

This command was introduced in OcNOS version 6.0.0.

Example

1. The below configuration example illustrates how to enter the NetConf Callhome configuration mode.

```
#configure terminal
(config)#netconf callhome
```

2. Check the NetConf Callhome configuration using the **show running-config netconf-callhome** command.

```
(netconf-callhome)#do show running-config netconf-callhome
!
netconf callhome
!
(netconf-callhome)#exit
```

reconnect

Use this command to enable or disable the reconnect feature in OcNOS, allowing users to control whether the system attempts to re-establish a connection if it fails. When enabled, OcNOS will make repeated connection attempts if the initial connection fails. If disabled, OcNOS will make only a single connection attempt; if it fails, it will not re-attempt the connection.

Command Syntax

```
reconnect (enable|disable)
```

Parameters

enable

Enable reconnect

disable

Disable reconnect

Default

By default, the reconnect feature is not enabled.

Command Mode

NetConf call home mode

Applicability

This command was introduced in OcNOS version 6.0.0.

Example

1. Check the existing NetConf Callhome configuration using the **show running-config netconf-callhome** command.

```
(netconf-callhome)#do show running-config netconf-callhome
!  
netconf callhome  
  feature netconf callhome enable  
!
```

2. Enable Reconnect:

```
(netconf-callhome)#reconnect enable  
(netconf-callhome)#commit
```

3. Check the current NetConf Callhome configuration using the **show running-config netconf-callhome** command.

```
(netconf-callhome)#do show running-config netconf-callhome
!  
netconf callhome  
  feature netconf callhome enable  
  reconnect enable  
!
```

4. Configure Retry Attempts and Interval for the system to re-establish a connection after failing a maximum number of attempts with a specified time interval.

```
(netconf-callhome)#retry-max-attempts 10
(netconf-callhome)#retry-interval 30
(netconf-callhome)#commit
```

5. Check the current NetConf Callhome configuration using the **show running-config netconf-callhome** command.

```
(netconf-callhome)#do show running-config netconf-callhome
!
netconf callhome
  feature netconf callhome enable
  reconnect enable
  retry-max-attempts 10
  retry-interval 30
!
```

6. Disable Reconnect:

```
(netconf-callhome)#reconnect disable
(netconf-callhome)#commit
```

7. Check the current NetConf Callhome configuration using the **show running-config netconf-callhome** command.

```
(netconf-callhome)#do show running-config netconf-callhome
!
netconf callhome
  feature netconf callhome enable
!
(netconf-callhome)#
```

retry-interval

Use this command to specify the number of seconds to wait after a connect attempt to the call home server fails. Use the `no` form of this command to reset the retry interval to its default (300 seconds).

Command Syntax

```
retry-interval <1-86400>
no retry-interval
```

Parameters

<1-86400>

Retry interval in seconds

Default

By default, when the [reconnect \(page 1125\)](#) feature is enabled, the default retry interval is 300 seconds.

Mode

NetConf call home mode

Applicability

This command was introduced in OcNOS version 6.0.0.

Example

1. Enable the NetConf callhome feature and reconnect commands:

```
(netconf-callhome)#do show running-config netconf-callhome
!
netconf callhome
  feature netconf callhome enable
  reconnect enable
!
```

2. Configure retry interval:

```
(netconf-callhome)#retry-interval 100
(netconf-callhome)#commit
(netconf-callhome)#
```

3. Check the NetConf callhome show output:

```
(netconf-callhome)#do show running-config netconf-callhome
!
netconf callhome
  feature netconf callhome enable
  reconnect enable
  retry-interval 100
!
```

4. Reset the interval:

```
(netconf-callhome)#no retry-interval
(netconf-callhome)#commit
```

5. Check the NetConf callhome show output:

```
(netconf-callhome)#do show running-config netconf-callhome
!
netconf callhome
  feature netconf callhome enable
  reconnect enable
!
(netconf-callhome)#exit
```

retry-max-attempts

Use this command to specify the number of retries the OcNOS should attempt to the call home server before giving up.

Use the **no** form of this command to reset the maximum attempts to its default value (3).

Command Syntax

```
retry-max-attempts <0-255>
no retry-max-attempts
```

Parameters

<0-255>

Number of retries; specify zero (0) to retry infinitely.

Default

By default, when the [reconnect \(page 1125\)](#) feature is enabled, 3 attempts will be made.

Command Mode

NetConf call home mode

Applicability

This command was introduced in OcNOS version 6.0.0.

When users update the reconnect parameters, note the following:

- Servers that haven't completed the configured retry count with the updated configurations will be included in the new count.
- Servers for which the configured retry count has already been completed will restart the retrial process with the new configuration.

Example

1. Enable the NetConf callhome feature and reconnect commands:

```
(netconf-callhome)#do show running-config netconf-callhome
!
netconf callhome
  feature netconf callhome enable
  reconnect enable
!
```

2. Configure retry maximum attempts:

```
(netconf-callhome)#retry-max-attempts 10
(netconf-callhome)#commit
(netconf-callhome)#
```

3. Check the NetConf callhome show output:

```
(netconf-callhome)#do show running-config netconf-callhome
```



```
!  
netconf callhome  
  feature netconf callhome enable  
  reconnect enable  
  retry-max-attempts 10  
!
```

4. Reset the attempts to its default value:

```
(netconf-callhome)#no retry-max-attempts  
(netconf-callhome)#commit
```

5. Check the NetConf callhome show output:

```
(netconf-callhome)#do show running-config netconf-callhome  
!  
netconf callhome  
  feature netconf callhome enable  
  reconnect enable  
!  
(netconf-callhome)#exit
```

show (xml|) running-config netconf-callhome

Use this command to display call home configurations.

Command Syntax

```
show (xml|) running-config netconf-callhome
```

Parameters

xml

Display the output in XML format

Command Mode

Execution mode

Applicability

This command was introduced in OcNOS version 6.0.0.

Example

The below show command displays the running configuration of the Netconf Callhome feature in a normal format.

```
#show running-config netconf-callhome
!
netconf callhome
  feature netconf callhome enable
  management-port xe10
  reconnect enable
  retry-max-attempts 10
  retry-interval 100
  callhome server local-nc 192.168.56.1
  debug callhome
!
```

The below show command displays the running configuration of the Netconf Callhome feature in XML format.

```
#show xml running-config netconf-callhome
<netconf-server xmlns="http://www.ipinfusion.com/yang/ocnos/ipi-management-server">
  <callhome>
    <feature-enabled></feature-enabled>
    <management-port>xe10</management-port>
    <netconf-client>
      <name>local-nc</name>
      <address>192.168.56.1</address>
    </netconf-client>
    <reconnect>
      <enable></enable>
      <retry-max-attempts>10</retry-max-attempts>
      <retry-interval>100</retry-interval>
    </reconnect>
  </callhome>
  <debug>
    <callhome-debug></callhome-debug>
  </debug>
</netconf-server>
```

SECURITY MANAGEMENT CONFIGURATION

Access Control Lists Configurations	1134
Overview	1134
IPv4 ACL Configuration	1134
ICMP ACL Configuration	1135
Access List Entry Sequence Numbering	1136
IPv6 ACL Configuration	1137
MAC ACL Configuration	1138
Management ACL Overview	1139
Management ACL Configuration	1139
ARP ACL Overview	1143
Topology	1143
ARP ACL Configuration	1143
ACL OVER LOOPBACK	1144
Topology	1144
Loopback ACL Configuration	1144
ACL OVER VTY	1146
VTY ACL Configuration	1147
Timed ACL	1148
Configuration with ipv4 Address	1148
Configuration with ipv6 Address	1149
Configuration with mac	1149
ACL on IRB Interface over VXLAN EVPN	1151
Topology	1151
ACLs Configuration on IRB	1151
Validation	1157
Dynamic ARP Inspection	1159
Overview	1159
Enable/Disable the Ingress DHCP-snoop TCAM group	1159
Enable/Disable the Ingress DHCP-snoop-IPv6 TCAM group	1160
Enable DHCP Snooping and DAI Globally	1160
Enable DHCP Snooping and DAI on a VLAN	1160
Enable/Disable IP DHCP Snooping ARP-inspection Validate	1161
Configuring the Ports Connected to DHCP Server and DHCP Client	1161
Configuring Trusted and Un-trusted Ports	1162
Validation	1162
Proxy ARP and Local Proxy ARP	1163
Overview	1163

Topology	1163
Validation	1164
Local Proxy ARP Overview	1165
DHCP Snooping	1168
Overview	1168
Topology	1169
Configuration	1169
Configuring the Ports Connected to DHCP Server and DHCP Client	1171
Configuring Trusted and Un-trusted Ports	1172
IDHCP Snooping Operation	1173
DHCP Snooping with Option-82	1175
Procedures	1176
Validation	1178
Sample server dhcpd.conf for option-82	1180
DHCP Snooping IP Source Guard	1181
Overview	1181
Topology	1181
Configuring the Ports Connected to DHCP Server and DHCP Client	1182
Configuring Trusted and Un-trusted Ports	1184
Configuring IP Source Guard on LAG Port	1185
DHCP Snooping over MLAG	1187
Overview	1187
Configuration	1188
No IP Unreachable	1199
Overview	1199
Supported ICMP Unreachable Codes	1199
Supported ICMPv6 Unreachable Codes	1200
Feature Characteristics	1200
Benefits	1200
Configuration	1200
No IP Unreachable Unconfiguration	1203
No IPv6 Unreachable Unconfiguration	1204
CLI Commands	1204
Port Breakout Configuration	1206
VLAN Port Breakout Configuration	1207
Port Breakout (100G and 400G) on Tomahawk and Trident Series Platforms	1215
Overview	1215

Access Control Lists Configurations

This chapter contains a complete example of access control list (ACL) configuration.

Overview

An Access Control List is a list of Access Control Entries (ACE). Each ACE in ACL specifies the access rights allowed or denied.

Each packet that arrives at the device is compared to each ACE in each ACL in the order they are defined. The device continues to look until it has a match. If no match is found and the device reaches the end of the list, the packet is denied. For this reason, place the most frequently occurring specifications at the top of the list.

The device stops checking the specifications after a match occurs.



Note: If there is no match, the packet is dropped (implicit deny). Therefore, an ACL intended to deny a few selected packets should have at least one permit filter of lower priority; otherwise, all traffic is dropped because of the default implicit deny filter.

Topology

Figure 59. ACL sample topology

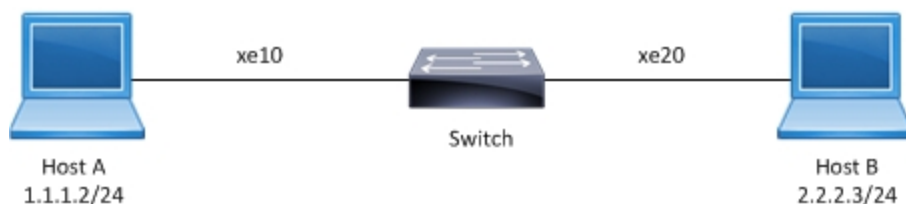

IPv4 ACL Configuration

<code>#configure terminal</code>	Enter configure mode.
<code>(config)#ip access-list T1</code>	Create an IP access list named T1.
<code>(config-ip-acl)#deny any host 1.1.1.1 any</code>	Create an access rule to deny IP packets with source address 1.1.1.1.
<code>(config-ip-acl)#permit any host 1.1.1.1 any</code>	Create an access rule to permit IP packets with source address 1.1.1.1.
<code>(config-ip-acl)#exit</code>	Exit access list mode.
<code>(config)#interface xe10</code>	Enter interface mode.
<code>(config-if)#no switchport</code>	Configure the interface as Layer 3.
<code>(config-if)#ip address 1.1.1.3/24</code>	Assign an IP address.
<code>(config-if)#ip access-group T1 in</code>	Apply access group T1 for inbound traffic to the interface.
<code>(config-if)#exit</code>	Exit interface and configure mode.

Validation

Use the commands below to verify the match count. When inbound IP packets reach interface xe10 with source address 1.1.1.1, then the match count for access rule 10 increases equal to the number of packets sent.

```
#show ip access-lists T1
IP access list T1
  10 deny any host 1.1.1.1 any [match=200]
  20 permit any 1.1.1.1/24 any
  default deny-all
```

When inbound IP packets reach interface xe10 with a source address in the range from 1.1.1.1 to 1.1.1.254, then the match count for access rule 20 increases equal to the number of packets sent.

```
#show ip access-lists T1
IP access list T1
  10 deny any host 1.1.1.1 any
  20 permit any 1.1.1.1/24 any [match=2000]
  default deny-all
```



Note: Use the command `clear ip access-list counters` to clear the statistics of all ACLs or `clear ip access-list <access-list name> counters` to clear statistics of a particular ACL.

ICMP ACL Configuration

<code>#configure terminal</code>	Enter configure mode.
<code>(config)#ip access-list icmp-acl-01</code>	Create an IP access list named icmp-acl-01.
<code>(config-ip-acl)#deny icmp 1.1.1.1/24 2.2.2.2/24 dscp af11</code>	Create an access rule with sequence number 10 to deny ICMP ¹ packets from a specific source towards a specific destination with a DSCP value of af11. Note: The sequence number is optional.
<code>(configip-acl)#20 permit icmp 1.1.1.1/24 2.2.2.2/24 precedence flash</code>	Create an access rule with sequence number 20 to permit ICMP packets from a specific source towards a specific destination with precedence as flash.
<code>(config-ip-acl)#exit</code>	Exit access list mode.
<code>(config)#interface xe10</code>	Enter interface mode.
<code>(config-if)#no switchport</code>	Configure the interface as Layer 3.
<code>(config-if)#ip address 1.1.1.3/24</code>	Assign an IP address.
<code>(config-if)#ip access-group icmp-acl-01 in</code>	Apply access group icmp-acl-01 for inbound traffic to the interface.
<code>(config-if)#exit</code>	Exit interface and configure mode.

¹Internet Control Message Protocol (ICMP) is a fundamental protocol used in networking to relay error messages and operational information.

Validation

Use the commands below to verify the match count. When inbound IP packets reach interface xe10 with source address 1.1.1.X, destination address 2.2.2.X, DSCP value af11, and are fragmented, then the count for access rule 10 increases equal to the number of packets sent.

```
#show ip access-lists icmp-acl-01
IP access-list icmp-acl-01
  deny icmp 1.1.1.1/24 2.2.2.2/24 precedence flash [match=200]
  20 permit icmp 1.1.1.1/24 2.2.2.2/24 precedence flash
  default deny-all
```

When inbound IP packets reach interface xe10 with source address as 1.1.1.X, destination address 2.2.2.X, and precedence value flash, then the count for access rule 20 increases equal to the number of packets sent.

```
#show ip access-lists icmp-acl-01
IP access-list icmp-acl-01
  deny icmp 1.1.1.1/24 2.2.2.2/24 precedence flash
  20 permit icmp 1.1.1.1/24 2.2.2.2/24 precedence flash [match=200]
  default deny-all
```



Note: Use the command `clear ip access-list counters` to clear statistics of all ACLs configured or `clear ip access-list <access-list name> counters` to clear statistics of a particular ACL.

Access List Entry Sequence Numbering

You can change the sequence numbers of rules in an access list.



Note: Re-sequencing an ACL attached to a management interface clears the ACL counters associated to it.

#configure terminal	Enter configure mode.
(config)#ip access-list icmp-acl-01	Enter access list mode for ACL icmp-acl-01.
(config-ip-acl)#resequence 100 200	Re-sequence the access list, starting with sequence number 100 and incrementing by 200.
(config-ip-acl)#1000 deny icmp 1.1.1.2/24 2.2.2.2/24 dscp af11	Re-sequencing specific access rule 100 with sequence number 1000
(config-ip-acl)#exit	Exit access list mode.

Validation

Before re-sequencing:

```
#show access-lists icmp-acl-01
IP access list icmp-acl-01
  deny icmp 1.1.1.1/24 2.2.2.2/24 precedence flash log
  20 permit icmp 1.1.1.1/24 2.2.2.2/24 precedence flash
  default deny-all
```

After re-sequencing the access list, starting with sequence number 100 and incrementing by 200

```
#show access-lists icmp-acl-01
IP access list icmp-acl-01
  100 deny icmp 1.1.1.2/24 2.2.2.2/24 dscp af11 log
  300 permit icmp 1.1.1.1/24 2.2.2.2/24 precedence flash
  default deny-all
```

After re-sequencing specific access rule 100 with sequence number 1000

```
#show access-lists icmp-acl-01
IP access list icmp-acl-01
  300 permit icmp 1.1.1.1/24 2.2.2.2/24 precedence flash
  1000 deny icmp 1.1.1.2/24 2.2.2.2/24 dscp af11 log
  default deny-all
```

IPv6 ACL Configuration

#configure terminal	Enter configure mode.
(config)#ipv6 access-list ipv6-acl-01	Create an IPv6 access list named as icmp-acl-01.
(config-ipv6-acl)#11 deny ipipv6 any any flow-label 100	Create access rule sequence number 11 to deny IPv4 encapsulated packets in IPv6 with any source address to any destination address with flow label 100.
(config-ipv6-acl)#default permit-all	Update the default rule to permit all.
(config-ipv6-acl)#exit	Exit access list mode
(config)#interface xe10	Enter interface mode.
(config-if)#no switchport	Configure the interface as Layer 3.
(config-if)#ipv6 address 1:1::1:3/64	Assign an IPv6 address.
(config-if)# ipv6 access-group ipv6-acl-01 in	Apply access group ipv6-acl-01 for inbound traffic to the interface.
(config-if)#exit	Exit interface and configure mode.

Validation

Use the commands below to verify the match count. When inbound IPv6 packets reach interface xe10 with IPv4 packets encapsulated with flow label 100, then count for access rule 11 increases equal to the number of packets sent.

```
#show ipv6 access-lists ipv6-acl-01
IPv6 access-list ipv6-acl-01
  11 deny ipipv6 any any flow-label 100 [match=1000]
  default permit all
```

For all other IPv6 packets, access rule 100 is invoked and the match counts increase equal to the number of packets sent.

```
#show ipv6 access-lists ipv6-acl-01
IPv6 access-list ipv6-acl-01
  11 deny ipipv6 any any flow-label 100
  default permit-all [match=2000]
```



Note: Use the command `clear ipv6 access-list counters` to clear statistics of all IPv6 ACLs configured or `clear ipv6 access-list <ipv6 access-list name> counters` to clear statistics of the particular IPv6 ACL.

MAC ACL Configuration

<code>#configure terminal</code>	Enter configure mode.
<code>(config)#mac access-list mac-acl-01</code>	Create a MAC access list named mac-acl-01.
<code>(config-mac-acl)#22 permit host 0000.0011.1212 host 0000.1100.2222 vlan 2</code>	Create an access rule with sequence number 22 to permit packets from a host with a specific MAC towards a host with a specific MAC with VLAN 2.
<code>(config-mac-acl)#exit</code>	Exit access list mode.
<code>(config)#bridge 1 protocol rstp vlan-bridge</code>	Create a VLAN-aware RSTP bridge.
<code>(config)#vlan 2 bridge 1 state enable</code>	Create VLAN 2.
<code>(config)#interface xe10</code>	Enter interface mode.
<code>(config-if)#switchport</code>	Configure the interface as Layer 2.
<code>(config-if)#bridge-group 1</code>	Associate the interface with bridge group 1.
<code>(config-if)#switchport mode trunk</code>	Set the switching characteristics of this interface to trunk mode.
<code>(config-if)#switchport trunk allowed vlan all</code>	Enable all VLAN identifiers on this interface.
<code>(config-if)# mac access-group mac-acl-01 in</code>	Applies the MAC access list mac-acl-01 to ingress traffic.
<code>(config-if)#exit</code>	Exit interface and configure mode.

Validation

Use the commands below to verify the match count. When inbound packets reach interface xe10 with the specific source and destination MAC with the VLAN as 2, then the count for access rule 22 increases equal to the number of packets sent.

```
#show mac access-lists
MAC access list mac-acl-01
  22 permit mac host 0000.0011.1212 host 0000.1100.2222 vlan 2 [match=3000]
  default deny-all
```

For all other packets, default rule is invoked and the match counts increases equal to the number of packets sent.

```
#show mac access-lists mac-acl-01
MAC access list mac-acl-01
  22 permit mac host 0000.0011.1212 host 0000.1100.2222 vlan 2
  default deny-all [match=2000]
```



Notes:

- As per the present design, ARP/ND packets will be filtered based on the source MAC address only (host mac address).
- Use the command `clear mac access-list counters` to clear statistics of all MAC ACLs or `clear mac access-list <mac access-list name> counters` to clear statistics of a particular MAC ACL.

Management ACL Overview

Management Port ACL can be used to provide basic level of security for accessing the management network. ACLs can also be used to decide which types of management traffic to be forwarded or blocked at the management port.

When configuring access list on a router or a switch, each access list needs to be identified by a unique name or a number. Each access list entry can have permit or deny actions. Each entry will be associated with a sequence number in the range of <1-268435453>. Lower the sequence number, higher the priority.

User should be able to configure the system to allow certain IP address for a protocol and don't allow any other IP address matching for that protocol.



Note: If there is no match, the packet is dropped (implicit deny). Therefore, an ACL intended to deny a few selected packets should have at least one permit filter of lower priority; otherwise, all traffic is dropped because of the default implicit deny filter.

Topology

Figure 60. Management ACL Sample Topology

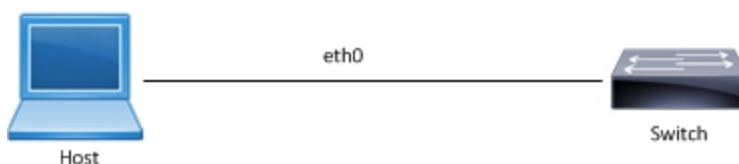

Management ACL Configuration

<code>#configure terminal</code>	Enter configure mode.
<code>(config)#ip access-list mgmt</code>	Create an IP access list named mgmt
<code>(config-ip-acl)#permit tcp host 10.12.45.57 host 10.12.29.49 eq ssh</code>	Create an access rule to permit TCP connection with source address 10.12.45.57 with destination address 10.12.29.49 on destination port equal to SSH.
<code>(config-ip-acl)#permit tcp host 10.12.45.58 host 10.12.29.49 eq telnet</code>	Create an access rule to permit TCP connection with source address 10.12.45.58 with Destination address 10.12.29.49 on destination port equal to Telnet.
<code>(config-ip-acl)#permit udp any host 10.12.29.49</code>	Create an access rule to permit UDP ¹ packet with any

¹User Datagram Protocol

eq snmp	source address with Destination address 10.12.29.49 on destination port equal to SNMP.
(config-ip-acl)#permit udp any host 10.12.29.49 eq ntp	Create an access rule to permit UDP packet with any source address with Destination address 10.12.29.49 on destination port equal to NTP.
(config-ip-acl)#permit udp host 10.12.29.49 any eq snmptrap	Create an access rule to permit UDP packet with source address 10.12.29.49 with any Destination address on destination port equal to SNMPTrap.
(config-ip-acl)#permit tcp host 10.12.29.49 eq ssh host 10.12.45.57	Create an access rule to permit TCP connection with source address 10.12.29.49 on source port equal to ssh with Destination address 10.12.45.57.
(config-ip-acl)#deny tcp host 10.12.45.58 host 10.12.29.49 eq ssh	Create an access rule to deny TCP connection with source address 10.12.45.58 with Destination address 10.12.29.49 on destination port equal to SSH.
(config-ip-acl)# deny tcp host 10.12.45.57 host 10.12.29.49 eq telnet	Create an access rule to deny TCP connection with source address 10.12.45.57 with Destination address 10.12.29.49 on destination port equal to Telnet.
(config-ip-acl)#exit	Exit access list mode.
(config)#interface eth0	Enter interface mode of Management Interface.
(config-if)#no switchport	Configure the interface as Layer 3.
(config-if)#ip address 10.12.29.49/24	Assign an IP address.
(config-if)#ip access-group mgmt in	Apply access group mgmt for inbound traffic to the interface.
(config-if)#exit	Exit interface and configure mode.

Validation

Use the commands below to verify the match count. When a TCP connection for Destination Port SSH reach interface eth0 with source address 10.12.45.57, then the match count for access rule 10 increases equal to the number of packets sent.

```
#show ip access-lists mgmt
IP access list mgmt
 10 permit tcp host 10.12.45.57 host 10.12.29.49 eq ssh [match=9]
 20 permit tcp host 10.12.45.58 host 10.12.29.49 eq telnet
 30 permit udp any host 10.12.29.49 eq snmp
 40 permit udp any host 10.12.29.49 eq ntp
 50 permit udp host 10.12.29.49 any eq snmptrap
 60 permit tcp host 10.12.29.49 eq ssh host 10.12.45.57
 70 deny tcp host 10.12.45.58 host 10.12.29.49 eq ssh
 80 deny tcp host 10.12.45.57 host 10.12.29.49 eq telnet
default deny-all
```

When a TCP connection for Destination Port Telnet reach interface eth0 with source address 10.12.45.58, then the match count for access rule 20 increases equal to the number of packets sent.

```
#show ip access-lists mgmt
IP access list mgmt
 10 permit tcp host 10.12.45.57 host 10.12.29.49 eq ssh
 20 permit tcp host 10.12.45.58 host 10.12.29.49 eq telnet [match=10]
 30 permit udp any host 10.12.29.49 eq snmp
```

```

40 permit udp any host 10.12.29.49 eq ntp
50 permit udp host 10.12.29.49 any eq snmptrap
60 permit tcp host 10.12.29.49 eq ssh host 10.12.45.57
70 deny tcp host 10.12.45.58 host 10.12.29.49 eq ssh
80 deny tcp host 10.12.45.57 host 10.12.29.49 eq telnet
default deny-all

```

When a UDP packet for Destination Port SNMP reach interface eth0 with any source address, then the match count for access rule 30 increases equal to the number of packets sent. Prior to this SNMP should be configured on Device (10.12.29.49).

Example:

```

snmp-server community SNMPTEST group network-admin vrf management
snmp-server host 10.12.6.86 traps version 2c SNMPTEST udp-port 162 vrf management
snmp-server enable snmp vrf management

```

```

#show ip access-lists mgmt
IP access list mgmt
 10 permit tcp host 10.12.45.57 host 10.12.29.49 eq ssh
 20 permit tcp host 10.12.45.58 host 10.12.29.49 eq telnet
 30 permit udp any host 10.12.29.49 eq snmp [match=50]
 40 permit udp any host 10.12.29.49 eq ntp
 50 permit udp host 10.12.29.49 any eq snmptrap
 60 permit tcp host 10.12.29.49 eq ssh host 10.12.45.57
 70 deny tcp host 10.12.45.58 host 10.12.29.49 eq ssh
 80 deny tcp host 10.12.45.57 host 10.12.29.49 eq telnet
default deny-all

```

When a UDP packet for Destination Port NTP reach interface eth0 with any source address, then the match count for access rule 40 increases equal to the number of packets sent. Prior to this NTP should be configured on Device (10.12.29.49).

Example:

```

ntp enable vrf management
ntp authenticate vrf management
ntp authentication-key 123 md5 swwx 7 vrf management
ntp trusted-key 123 vrf management
ntp server 10.12.45.36 vrf management
ntp server 10.12.16.16 prefer vrf management
ntp server 10.12.16.16 key 123 vrf management

```

```

#show ip access-lists mgmt
IP access list mgmt
 10 permit tcp host 10.12.45.57 host 10.12.29.49 eq ssh
 20 permit tcp host 10.12.45.58 host 10.12.29.49 eq telnet
 30 permit udp any host 10.12.29.49 eq snmp
 40 permit udp any host 10.12.29.49 eq ntp [match=1]
 50 permit udp host 10.12.29.49 any eq snmptrap
 60 permit tcp host 10.12.29.49 eq ssh host 10.12.45.57
 70 deny tcp host 10.12.45.58 host 10.12.29.49 eq ssh
 80 deny tcp host 10.12.45.57 host 10.12.29.49 eq telnet
default deny-all

```

When a TCP connection request for Destination Port SSH reach interface eth0 with source address 10.12.45.58, this should deny the connection and the match count for access rule 70 increases equal to the number of packets sent.

```

#show ip access-lists mgmt
IP access list mgmt
 10 permit tcp host 10.12.45.57 host 10.12.29.49 eq ssh
 20 permit tcp host 10.12.45.58 host 10.12.29.49 eq telnet
 30 permit udp any host 10.12.29.49 eq snmp
 40 permit udp any host 10.12.29.49 eq ntp
 50 permit udp host 10.12.29.49 any eq snmptrap
 60 permit tcp host 10.12.29.49 eq ssh host 10.12.45.57

```

```
70 deny tcp host 10.12.45.58 host 10.12.29.49 eq ssh [match=1]
80 deny tcp host 10.12.45.57 host 10.12.29.49 eq telnet
default deny-all
```

When a TCP connection request for Destination Port Telnet reach interface eth0 with source address 10.12.45.57, this should deny the connection and the match count for access rule 80 increases equal to the number of packets sent.

```
#show ip access-lists mgmt
IP access list mgmt
 10 permit tcp host 10.12.45.57 host 10.12.29.49 eq ssh
 20 permit tcp host 10.12.45.58 host 10.12.29.49 eq telnet
 30 permit udp any host 10.12.29.49 eq snmp
 40 permit udp any host 10.12.29.49 eq ntp
 50 permit udp host 10.12.29.49 any eq snmptrap
 60 permit tcp host 10.12.29.49 eq ssh host 10.12.45.57
 70 deny tcp host 10.12.45.58 host 10.12.29.49 eq ssh
 80 deny tcp host 10.12.45.57 host 10.12.29.49 eq telnet[match=1]
default deny-all
```

To enable SNMPTRAPS, apply the ACL outbound to the Management interface.

#configure terminal	Exit access list mode.
(config)#interface eth0	Enter interface mode of Management Interface.
(config-if)#ip access-group mgmt out	Apply access group mgmt for outbound traffic to the interface.
(config-if)#exit	Exit interface and configure mode.

When a UDP packet for Destination Port SNMPTrap sends out of interface eth0 with any Destination address, then the match count for access rule 50 increases equal to the number of packets received. Prior to this SNMPTrap should be configured on Device (10.12.29.49) to listen to port 162.

```
Example:
snmp-server community SNMPTEST group network-admin vrf management
snmp-server host 10.12.6.86 traps version 2c SNMPTEST udp-port 162 vrf management
snmp-server enable snmp vrf management

#show ip access-lists mgmt
IP access list mgmt
 10 permit tcp host 10.12.45.57 host 10.12.29.49 eq ssh
 20 permit tcp host 10.12.45.58 host 10.12.29.49 eq telnet
 30 permit udp any host 10.12.29.49 eq snmp
 40 permit udp any host 10.12.29.49 eq ntp
 50 permit udp host 10.12.29.49 any eq snmptrap [match=5]
 60 permit tcp host 10.12.29.49 eq ssh host 10.12.45.57
 70 deny tcp host 10.12.45.58 host 10.12.29.49 eq ssh
 80 deny tcp host 10.12.45.57 host 10.12.29.49 eq telnet
default deny-all
```

When an ACL is applied on interface eth0 outbound and inbound together, then we must configure an ACL to establish a TCP connection between source 10.12.29.49 with source Port SSH to destination address 10.12.45.57. When a TCP connection is established on port SSH, then the match count for access rule 10 and 60 increases equal to the number of packets sent and received.

```
#show ip access-lists mgmt
IP access list mgmt
 10 permit tcp host 10.12.45.57 host 10.12.29.49 eq ssh [match=9]
 20 permit tcp host 10.12.45.58 host 10.12.29.49 eq telnet
 30 permit udp any host 10.12.29.49 eq snmp
 40 permit udp any host 10.12.29.49 eq ntp
```

```

50 permit udp host 10.12.29.49 any eq snmptrap
60 permit tcp host 10.12.29.49 eq ssh host 10.12.45.57[match=9]
70 deny tcp host 10.12.45.58 host 10.12.29.49 eq ssh
80 deny tcp host 10.12.45.57 host 10.12.29.49 eq telnet
default deny-all

```



Note: Use the command `clear ip access-list counters` to clear the statistics of all ACLs or `clear ip access-list <access-list name> counters` to clear statistics of a particular ACL.

```

#show ip access-lists mgmt
IP access list mgmt
 10 permit tcp host 10.12.45.57 host 10.12.29.49 eq ssh [match=9]
 20 permit tcp host 10.12.45.58 host 10.12.29.49 eq telnet
 30 permit udp any host 10.12.29.49 eq snmp
 40 permit udp any host 10.12.29.49 eq ntp
 50 permit udp host 10.12.29.49 any eq snmptrap
 60 permit tcp host 10.12.29.49 eq ssh host 10.12.45.57[match=9]
 70 deny tcp host 10.12.45.58 host 10.12.29.49 eq ssh
 80 deny tcp host 10.12.45.57 host 10.12.29.49 eq telnet
default deny-all

```

ARP ACL Overview

ARP ACL can be used to permit or deny the ARP packets, based on the ARP request or response option configured.

Topology

Figure 61. ARP ACL Sample Topology

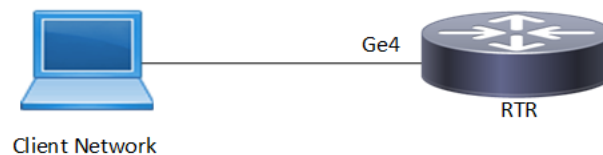

ARP ACL Configuration

<code>#configure terminal</code>	Enter configure mode.
<code>(config)#interface ge4</code>	Enter interface mode.
<code>(config-if)#ip address 11.11.11.11/24</code>	Assign IPv4 address.
<code>(config-if)#exit</code>	Exit access list mode.
<code>(config)# mac access-list mac1</code>	Enter mac access list mode.
<code>(config-mac-acl)#permit 0000.3ae0.456d 0000.0000.0000 any arp request</code>	Create an access rule to permit specific ARP request.
<code>(config-mac-acl)#permit 0000.3ae0.456d 0000.0000.0000 any arp response</code>	Create an access rule to permit specific ARP response.

<code>(config-mac-acl)#permit any any ipv4</code>	Create an access rule to permit any IPv4 packet.
<code>(config-mac-acl)#exit</code>	Exit access list mode.
<code>(config)#interface ge4</code>	Enter interface mode.
<code>(config-if)#mac access-group mac1 in</code>	Apply access group mac1 for inbound traffic to the interface.
<code>(config-if)#exit</code>	Exit interface and configure mode.

Validation

Use the commands below to assign IP address on IXIA and ping from IXIA.

```
#show mac access-lists
MAC access list mac1
 10 permit host 0000.3AE0.456D any arp request [match=1]
 20 permit host 0000.3AE0.456D any arp response [match=1]
 30 permit any any ipv4 [match=1]
 default deny-all
```

ACL OVER LOOPBACK

The loopback interface ACL is the feature to be used to provide this basic level security for the management applications accessible through In-band interfaces.



Note: Refer to the command reference section for limitations, default behavior, and unsupported features.

Topology

Figure 62. ACL Loopback Topology

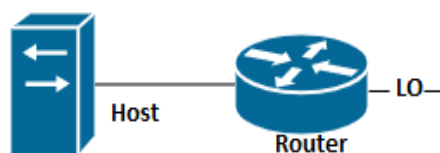

Loopback ACL Configuration

<code>#configure terminal</code>	Enter configure mode.
<code>(config)#interface lo</code>	Enter interface mode.
<code>(config-if)#ip address 3.3.3.3/32 secondary</code>	Assign the IPv4 secondary address.
<code>(config-if)#ip address 4.4.4.4/32 secondary</code>	Assign the IPv4 secondary address.

(config-if)#ip address 5.5.5.5/32 secondary	Assign the IPv4 secondary address.
(config-if)#ip address 6.6.6.6/32 secondary	Assign the IPv4 secondary address.
(config-if)#ip address 7.7.7.7/32 secondary	Assign the IPv4 secondary address.
(config-if)# exit	Exit interface mode.
(config)#ip access-list loopback	Create loopback access list
(config-ip-acl)# 10 permit tcp any host 3.3.3.3 eq telnet	Permit telnet session from any source with specific destination.
(config-ip-acl)# 20 deny tcp any host 4.4.4.4 eq telnet	Deny telnet session from any source with specific destination.
(config-ip-acl)# 30 permit tcp any host 5.5.5.5 eq ssh	Permit ssh session from any source with specific destination.
(config-ip-acl)# 40 deny tcp any host 6.6.6.6 eq ssh	Deny ssh session from any source with specific destination.
(config-ip-acl)# 50 deny udp any host 6.6.6.6 eq snmp	Deny udp from any source with specific destination.
(config-ip-acl)# 60 deny udp any host 7.7.7.7 eq ntp	Deny udp from any source with specific destination.
(config-ip-acl)#exit	Exit interface acl mode
(config)#interface lo	Enter interface lo mode
(config-if)#ip access-group loopback in	Associate loopback acl over lo interface
(config-if)#exit	Exit interface mode
(config)#exit	Exit config mode

Validation

Use the commands below to validate ACL loopback.

```
OcNOS#show access-lists
IP access list loopback
  10 permit tcp any host 3.3.3.3 eq telnet [match=12]
  20 deny tcp any host 4.4.4.4 eq telnet [match=12]
  30 permit tcp any host 5.5.5.5 eq ssh
  40 deny tcp any host 6.6.6.6 eq ssh
  50 deny udp any host 6.6.6.6 eq snmp [match=6]
  60 deny udp any host 7.7.7.7 eq ntp
```

```
OcNOS#show ip access-lists summary
IPV4 ACL loopback
  statistics enabled
  Total ACEs Configured: 6
  Configured on interfaces:
    lo - ingress (Router ACL)
  Active on interfaces:
    lo - ingress (Router ACL)
  Configured on line vty:
```

```
OcNOS#show running-config aclmgr
ip access-list loopback
  10 permit tcp any host 3.3.3.3 eq telnet
  20 deny tcp any host 4.4.4.4 eq telnet
  30 permit tcp any host 5.5.5.5 eq ssh
  40 deny tcp any host 6.6.6.6 eq ssh
```



```
50 deny udp any host 6.6.6.6 eq snmp
60 deny udp any host 7.7.7.7 eq ntp
!
interface lo
 ip access-group loopback in
!
```

ACL OVER VTY

When a Telnet/SSH/NetConf connection is established in the OcNOS, it associates the connection with a virtual terminal (VTY) line. The ACL over VTY feature provides security for management features associated with VTY.

Users can create Standard and Extended ACL rules and attach them to a virtual teletype (VTY) command line interface. These ACL rules are applied on both Management and Default virtual routing forwarding (VRFs).

OcNOS supports both IPv4 and IPv6 access lists for VTY lines, providing flexibility for network configurations.

Applying a standard ACL rule on a VTY line permits or denies only management access protocols such as SSH, Telnet, and SSH-Netconf protocols (port numbers 22,23,830)).

Extended ACL rules are applied as configured by the user, and it is not limited to management protocols only, unlike Standard ACLs.

When a user configures a rule with 'deny any any any' and attaches it to the VTY, it effectively blocks only the Telnet, SSH, and NetConf protocols on the control plane

For example, when a user configures a rule as below and attach them to VTY, If the deny ACL rule includes 'any' value in protocol, only Telnet/SSH/SSH-NetConf protocols are denied.

```
ip access-list ssh-access
10 permit tcp 10.12.43.0/24 any eq ssh
20 deny any any any
```



Note: To deny any protocols other than Telnet/SSH/SSH-Netconf, create a deny rule with the specific protocol access on VTY. For example: To deny OSPF protocol from all the source and destination address, apply the rule, 10 deny ospf any any.

In general, the VTY ACLs are more specific to management protocols. Hence, the Extended ACL “any” rule translation is enhanced to allow management protocols as follows:

- If the deny ACL rule includes any value in protocol, only Telnet/SSH/SSH-Netconf protocols are denied.
- The permit ACL rule is unchanged.



Note: Refer to the command reference section for limitations, default behavior, and unsupported features.

Topology

Figure 63. ACL VTY Topology

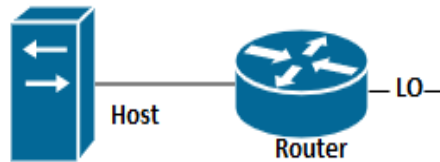

VTY ACL Configuration

#configure terminal	Enter configure mode.
(config)#interface lo	Enter interface mode.
(config-if)#ip address 3.3.3.3/32 secondary	Assign the IPv4 secondary address.
(config-if)# exit	Exit interface mode.
(config)#ip access-list vty	Create loopback access list
(config-ip-acl)# 10 permit tcp any host 3.3.3.3 eq telnet	Permit telnet session from any source with specific destination.
(config-ip-acl)#exit	Exit interface acl mode
(config)#line vty	Enter interface vty mode
(config-all-line)#ip access-group vty in	Associate acl over
(config-if)#exit	Exit interface mode
(config)#exit	Exit config mode

Validation

```
OcNOS#sh access-lists
IP access list vty
    10 permit tcp any host 3.3.3.3 eq telnet

OcNOS#sh ip access-lists summary
IPV4 ACL vty
    statistics enabled
    Total ACEs Configured: 1
    Configured on interfaces:
    Active on interfaces:
    Configured on line vty:
    all vty lines - ingress

OcNOS#sh running-config access-list
ip access-list vty
10 permit tcp any host 3.3.3.3 eq telnet
!
line vty
ip access-group vty in
```

Implementation Examples

```
OcNOS#show running-config aclmgr
ip access-list ssh-access
 10 permit tcp 10.12.43.0/24 any eq ssh
 20 deny tcp 10.12.33.0/24 any eq 6513
 30 deny any 10.12.34.0/24 any
 40 deny any any any
!
line vty
 ip access-group ssh-access in

#####iptables o/p#####

root@OcNOS:~# iptables -L
Chain INPUT (policy ACCEPT)
target     prot opt source                destination            tcp dpt:ssh
DROP      tcp  --  10.12.33.0/24          anywhere               tcp dpt:tls_netconf
DROP      tcp  --  10.12.34.0/24          anywhere               multiport dports ssh,telnet,ssh_netconf
DROP      tcp  --  anywhere              anywhere               multiport dports ssh,telnet,ssh_netconf
```

Timed ACL

The time range feature was introduced to be able to add a timing boundary for specified activities. The activity would start, end and repeat at the specific times set by the user. This time-range feature will enable creating "Timed ACLs". This will help service providers customize the internet data to customers based on time to increase the video traffic during weekends and reduce data traffic, restrict the internet traffic in school/college non-working hours etc.

Topology

Figure 64. Timed acl sample topology

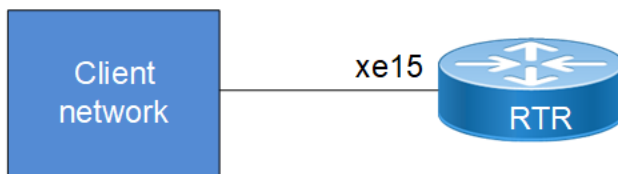

Configuration with ipv4 Address

#configure terminal	Enter configure mode.
(config)# time-range TIMER1	Configure a timer
(config-tr)#start-time 10:00 03 nov 2021	Configure start time
(config-tr)#end-time 18:00 03 nov 2021	Configure end time
(config-tr)#exit	Exit timer
(config)# ip access-list ACL1	Create ip access list
(config-ip-acl)# deny icmp host 10.1.1.1 host 10.1.2.2	Create an acl rule to deny icmp
(config-ip-acl)#exit	Exit Acl mode

(config)#hardware-profile filter egress-ipv4 enable	Hardware profile enable for the acl
(config)#int xe15	Enter into the interface mode
(config-if)#ip access-group ACL1 out time-range TIMER1	Apply the acl along with the timer.
(config-if)#commit	To save the changes
(config-if)#exit	Exit

Configuration with ipv6 Address

(config)# ipv6 access-list ACL1v6	Create ipv6 access list
(config-ipv6-acl)# deny any any any	Create an acl rule to deny
(config-ipv6-acl)#exit	Exit Acl mode
(config)# hardware-profile filter ingress-ipv6 enable	Hardware profile enable for the acl
(config)#int xe12	Enter into the interface mode
(config-if)# ipv6 access-group ACL1v6 in time-range TIMER1	
(config-if)#commit	To save the changes
(config-if)#exit	Exit

Configuration with mac

(config)# mac access-list ACL1mac	Create ip access list
(config-mac-acl)# deny 0000.0000.0000 1111.2222.3333 0000.0000.0000 4444.5555.6666	Create an acl rule to deny icmp
(config-mac-acl)#exit	Exit Acl mode
(config)# hardware-profile filter ingress-l2 enable	Hardware profile enable for the acl
(config)#int xe13	Enter into the interface mode
(config-if)# mac access-group ACL1mac in time-range TIMER1	
(config-if)#commit	To save the changes
(config-if)#exit	Exit

Validation

```
#sh running-config in xe15
!
interface xe15
 ip access-group ACL1 out time-range TIMER1
!
OcnOS#sh running-config in xe12
!
interface xe12
 ipv6 access-group ACL1v6 in time-range TIMER1
```

```
!  
OcnOS#sh running-config in xe13  
!  
interface xe13  
  mac access-group ACLlmac in time-range TIMER1  
  
#sh time-range  
=====  
TR handler interval: 10 seconds  
=====  
TR entries: 1  
Entry: 0  
  name: TIMER1  
  state: Pending  
  frequency: none  
  start time: Wed Nov  3 10:00:00 2021  
  end time: Wed Nov  3 18:00:00 2021  
=====  
RUNNING TR entries: 0  
=====  
COMPLETED TR entries: 0
```

ACL on IRB Interface over VXLAN EVPN

Applying ACLs to an Integrated Routing and Bridging (IRB) interface or switchport enables control over packet flow, whether ingress or egress the interface. This capability is essential for maintaining security, managing bandwidth, and ensuring effective routing and bridging.

Topology

In this topology, PE1 and PE2 routers have IRB interfaces configured. The IRB interfaces bridge VLAN traffic and route between VLANs, enabling communication between Layer 2 and Layer 3.

ACLs are applied on the IRB interfaces to filter traffic, ensuring only authorized traffic passes through. The P1 router acts as a transit router, forwarding traffic between PE1 and PE2. The P1 router provides core functionality but does not handle IRB interfaces directly.

This configuration ensures that while traffic flows across the network, ACL policies can be enforced at both PE1 and PE2 over the IRB interfaces, securing communication between VLANs and controlling access between external networks

Figure 65. ACL on IRB sample topology

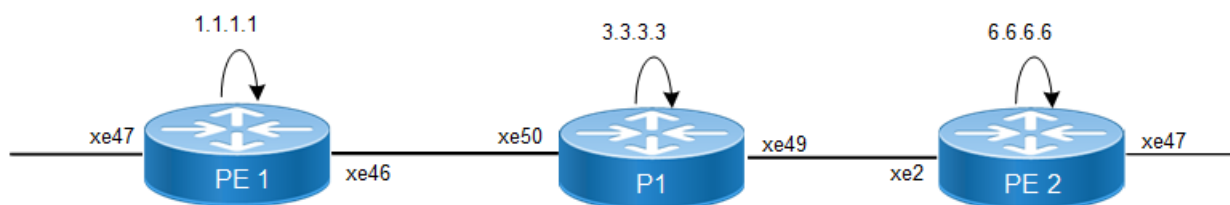

ACLs Configuration on IRB

Perform the following steps to enable EVPN VXLAN on an IRB interface while applying ACLs to control ingress or egress traffic:



Note: The required configuration for ACL on IRB is added in the Configuration section, for the detailed configuration on IRB symmetric and asymmetric refer to the *Base Configuration - L2 VxLAN* sub-section in the *VxLAN-EVPN with IRB* section of the *OcNOS VxLAN Guide*.

1. Enable Hardware Profiles for both IPv4 and IPv6 traffic at the ingress and egress of the interface:

```
PE1(config)#hardware-profile filter ingress-ipv6 enable
PE1(config)#hardware-profile filter egress-ipv6 enable
PE1(config)#hardware-profile filter ingress-ipv4 enable
PE1(config)#
```

2. Enable EVPN VXLAN:

```
PE1(config)#nvo vxlan enable
PE1(config)#nvo vxlan irb
PE1(config)#evpn vxlan multihoming enable # Only if multihoming is required
```

3. Configure an anycast MAC address for the gateway in a multihoming scenario, allowing multiple devices to share the same MAC address for redundancy:

```
PE1(config)#evpn irb-forwarding anycast-gateway-mac 0000.0000.1111
PE1(config)#
```

4. Define a MAC VRF¹ for isolating MAC address routing within the EVPN framework:

```
PE1(config)#mac vrf vxlan_l2_elan_sh
PE1(config-vrf)#rd 1.1.1.1:100
PE1(config-vrf)#route-target both 100:100
```



Note: Ensure to provide <RD value> with a value different from PE1's RD of 1.1.1.1 to maintain proper routing table separation and avoiding conflicts between the two PE devices.

5. Define an IP VRF for routing L3 traffic within the EVPN framework:

```
PE1(config)#ip vrf vxlan_l3_elan_sh
PE1(config-vrf)#rd 1111:300
PE1(config-vrf)#route-target both 300:300
PE1(config-vrf)#l3vni 5053
```



Note: Ensure to provide <rd value> with a value different from PE1's RD of 1.1.1.1 to maintain proper routing table separation and avoiding conflicts between the two PE devices.

6. Configure EVPN VXLAN for host reachability and specify the IRB interface:

```
PE1(config)#nvo vxlan id 50 ingress-replication inner-vid-disabled
PE1(config-nvo)#vxlan host-reachability-protocol evpn-bgp vxlan_l2_elan_mhsh
PE1(config-nvo)#evpn irb50
```

7. Configure access interface for VLAN encapsulation and map it to the EVPN instance:

```
PE1(config)#nvo vxlan access-if port-vlan xe57 3
PE1(config-nvo-acc-if)# map vnid 50

PE1(config-nvo-acc-if)#
```

8. Create ACL to filter incoming and outgoing traffic:

```
PE1(config)#ip access-list 50_DIST_SH
PE1(config-ip-acl)# 100 permit any host 50.1.1.2 any
PE1(config-ip-acl)# 101 deny any host 50.1.1.3 any
PE1(config-ip-acl)# 102 permit any host 50.1.1.4 any
PE1(config-ip-acl)# 103 deny any host 50.1.1.5 any
PE1(config-ip-acl)# default deny-all
PE1(config-ip-acl)#ip access-list 53_DIST_SH
PE1(config-ip-acl)# 100 deny any 53.1.1.0/24 any
PE1(config-ip-acl)# default deny-all
PE1(config-ip-acl)#ipv6 access-list 5000_DIST_SH
PE1(config-ipv6-acl)# 100 permit any 5000::/48 any
PE1(config-ipv6-acl)# default deny-all
PE1(config-ipv6-acl)#
```

¹Virtual Routing and Forwarding

9. Configure the IRB interface with IP addresses, associate it with the VRF, and apply the ACL:

```
PE1(config)#interface irb50
PE1(config-irb-if)# ip vrf forwarding vxlan_l3_elan_sh
PE1(config-irb-if)# evpn irb-if-forwarding anycast-gateway-mac
PE1(config-irb-if)# ip address 50.1.1.1/24
PE1(config-irb-if)# ipv6 address 5000::1/48
PE1(config-irb-if)# mtu 9200
PE1(config-irb-if)# ip access-group 50_DIST_SH in
PE1(config-irb-if)# ip access-group 53_DIST_SH out
PE1(config-irb-if)# ipv6 access-group 5000_DIST_SH in
```

Configuration Snapshot

PE1

```
PE1#show running-config
!
logging console 5
logging monitor 5
snmp-server enable traps link linkDown
snmp-server enable traps link linkUp
!
hardware-profile filter ingress-ipv6 enable
hardware-profile filter egress-ipv6 enable
hardware-profile filter ingress-ipv4 enable
!
bfd interval 3 minrx 3 multiplier 3
!
qos enable
!
hostname PE1
!
ip access-list 50_DIST_SH
 100 permit any host 50.1.1.2 any
 101 deny any host 50.1.1.3 any
 102 permit any host 50.1.1.4 any
 103 deny any host 50.1.1.5 any
default deny-all
ip access-list 53_DIST_SH
 100 deny any 53.1.1.0/24 any
default deny-all
!
ipv6 access-list 5000_DIST_SH
 100 permit any 5000::/48 any
default deny-all
!
vlan database
  vlan-reservation 4037-4094
!
nvo vxlan enable
!
nvo vxlan irb
!
evpn esi hold-time 90
!
evpn vxlan multihoming enable
!
ip vrf management
!
ip vrf vxlan_l3_elan_sh
 rd 1111:300
 route-target both 300:300
 l3vni 5053
!
```



```
mac vrf vxlan_l2_elan_sh
  description vxlan_l2_elan_sh
  rd 1.1.1.1:100
  route-target both 100:100
!
evpn irb-forwarding anycast-gateway-mac 0000.0000.1111
!
nvo vxlan vtep-ip-global 1.1.1.1
!
nvo vxlan id 50 ingress-replication inner-vid-disabled
  vxlan host-reachability-protocol evpn-bgp vxlan_l2_elan_sh
  evpn irb50
!
interface eth0
  ip vrf forwarding management
  ip address dhcp
!
interface irb50
  ip vrf forwarding vxlan_l3_elan_sh
  evpn irb-if-forwarding anycast-gateway-mac
  ip address 50.1.1.1/24
  ipv6 address 5000::1/48
  mtu 9200
  ip access-group 50_DIST_SH in
  ip access-group 53_DIST_SH out
  ipv6 access-group 5000_DIST_SH in
!
interface lo
  ip address 127.0.0.1/8
  ip address 1.1.1.1/32 secondary
  ipv6 address ::1/128
!
interface xe46
  description network_to_spine1
  load-interval 30
  ip address 11.1.1.1/24
  mtu 9200
!
interface xe47
  switchport
  load-interval 30
  mtu 9200
!
exit
!
router ospf 1
  ospf router-id 1.1.1.1
  bfd all-interfaces
  network 1.1.1.1/32 area 0.0.0.0
  network 11.1.1.0/24 area 0.0.0.0
!
router bgp 1
  bgp router-id 1.1.1.1
  neighbor 6.6.6.6 remote-as 1
  neighbor 6.6.6.6 update-source lo
!
  address-family ipv4 unicast
  max-paths ibgp 2
  redistribute connected
  exit-address-family
!
  address-family l2vpn evpn
  neighbor 6.6.6.6 activate
  exit-address-family
!
  address-family ipv4 vrf vxlan_l3_elan_sh
  max-paths ibgp 2
  redistribute connected
```

```
exit-address-family
!
address-family ipv6 vrf vxlan_l3_elan_sh
max-paths ibgp 2
redistribute connected
exit-address-family
!
exit
!
nvo vxlan access-if port-vlan xe47 3
map vnid 50
!
!
end
```

PE2

```
PE2#show running-config
!
logging console 5
logging monitor 5
snmp-server enable traps link linkDown
snmp-server enable traps link linkUp
!
hardware-profile filter ingress-ipv6 enable
hardware-profile filter egress-ipv6 enable
hardware-profile filter bfd-group disable
hardware-profile filter ingress-ipv4 enable
!
bfd interval 3 minrx 3 multiplier 3
!
qos enable
!
hostname PE2
!
ip access-list 53_DIST_SH
100 permit any 53.1.1.0/24 any
default deny-all
!
ipv6 access-list 5301_DIST_SH
100 deny any 5301::/48 any
default permit-all
!
vlan database
vlan-reservation 4000-4094
vlan 50 bridge 1 state enable
vlan 60 bridge 1 state enable
vlan 100-300 bridge 1 state enable
!
nvo vxlan enable
!
nvo vxlan irb
!
evpn vxlan multihoming enable
!
ip vrf management
!
ip vrf vxlan_l3_elan_sh
rd 6666:300
route-target both 300:300
l3vni 5053
!
mac vrf vxlan_l2_elan_sh2
description vxlan_l2_elan_sh
rd 6.6.6.6:200
route-target both 200:200
!
```

```
evpn irb-forwarding anycast-gateway-mac 0000.0000.1111
!
nvo vxlan vtep-ip-global 6.6.6.6
!
nvo vxlan id 53 ingress-replication inner-vid-disabled
vxlan host-reachability-protocol evpn-bgp vxlan_l2_elan_sh2
evpn irb53
!
interface eth0
 ip vrf forwarding management
 ip address dhcp
!
interface irb53
 ip vrf forwarding vxlan_l3_elan_sh
 evpn irb-if-forwarding anycast-gateway-mac
 ip address 53.1.1.1/24
 ipv6 address 5301::1/48
 mtu 9200
 ip access-group 53_DIST_SH in
 ipv6 access-group 5301_DIST_SH in
!
interface lo
 ip address 127.0.0.1/8
 ip address 6.6.6.6/32 secondary
 ipv6 address ::1/128
!
interface xe2
 description network_to_spine1
 load-interval 30
 ip address 17.1.1.1/24
 mtu 9200
!
interface xe47
 switchport
 load-interval 30
 mtu 9200
!
!
 exit
!
router ospf 1
 ospf router-id 6.6.6.6
 bfd all-interfaces
 network 6.6.6.6/32 area 0.0.0.0
 network 17.1.1.0/24 area 0.0.0.0
!
router bgp 1
 bgp router-id 6.6.6.6
 neighbor 1.1.1.1 remote-as 1
 neighbor 1.1.1.1 update-source lo
!
 address-family l2vpn evpn
 neighbor 1.1.1.1 activate
 exit-address-family
!
 address-family ipv4 vrf vxlan_l3_elan_sh
 max-paths ibgp 2
 redistribute connected
 exit-address-family
!
 address-family ipv6 vrf vxlan_l3_elan_sh
 max-paths ibgp 2
 redistribute connected
 exit-address-family
!
 exit
!
nvo vxlan access-if port-vlan xe47 9
```

```

map vnid 53
!
!
end

```

P1

```

P#show running-config
!
logging console 5
logging monitor 5
snmp-server enable traps link linkDown
snmp-server enable traps link linkUp
!
qos enable
!
hostname P
!
interface lo
 ip address 127.0.0.1/8
 ip address 1.1.1.1/32 secondary
 ipv6 address ::1/128
!
interface xe49
 load-interval 30
 ip address 17.1.1.2/24
 mtu 9200
!
interface xe50
 load-interval 30
 ip address 11.1.1.2/24
 mtu 9200
!
 exit
!
router ospf 1
 ospf router-id 3.3.3.3
 bfd all-interfaces
 network 3.3.3.3/32 area 0.0.0.0
 network 11.1.1.0/24 area 0.0.0.0
 network 17.1.1.0/24 area 0.0.0.0
!
end

```

Validation

Verify that after applying ACL, traffic drop/permit is seen as per policy and verify acl counters are increased accordingly:

```

PE1#show interface counters rate mbps
+-----+-----+-----+-----+
| Interface | Rx mbps | Rx pps | Tx mbps | Tx pps |
+-----+-----+-----+-----+
xe46        | 499.46  | 13304  | 239.42  | 6387   |
xe47        | 398.19  | 10674  | 0.00    | 0      |
PE1#

PE1#show access-lists
IP access list 50_DIST_SH
 100 permit any host 50.1.1.2 any [match=485136]
 101 deny any host 50.1.1.3 any [match=485135]

```

```
    102 permit any host 50.1.1.4 any [match=485134]
    103 deny any host 50.1.1.5 any [match=485132]
    default deny-all [match=2910786]
IP access list 53_DIST_SH
    100 deny any 53.1.1.0/24 any [match=4153575]
    default deny-all
IPv6 access list 5000_DIST_SH
    100 permit any 5000::/48 any [match=4719226]
    268435453 permit icmpv6 any any [match=55]
    default deny-all
```

Dynamic ARP Inspection

Overview

DAI (Dynamic ARP Inspection) is a security features that validates ARP packet in network by intercepting ARP packet and validating IP-to-MAC address binding learnt from **DHCP**¹ SNOOP.

DAI (Dynamic ARP Inspection) is a security measures which allows user to intercept, log and discard ARP packets with invalid MAC address to IP address binding. Once the DAI feature is enabled on the system, ARP packets are re-directed to software and validated against the MAC to IP binding data base before getting forwarded. ARP coming on untrusted port is inspected, validated and forwarded/dropped appropriately.

Topology

Figure 66. DAI Topology

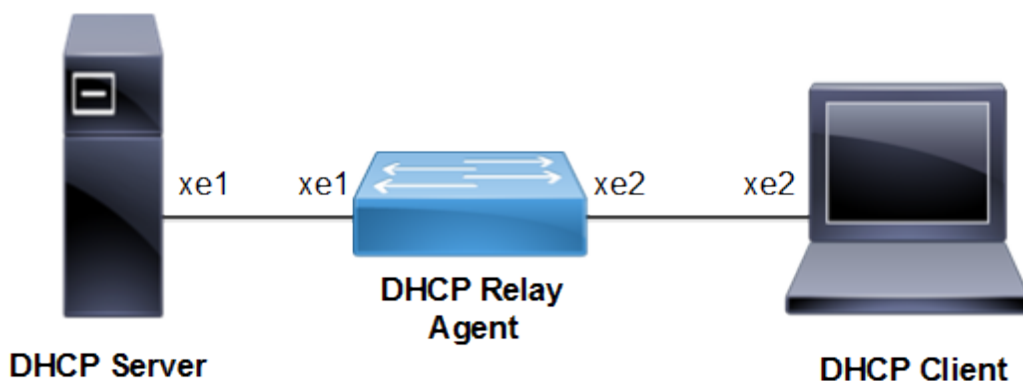

Enable/Disable the Ingress DHCP-snoop TCAM group

#configure terminal	Enter Configure mode.
(config)#hardware-profile filter dhcp-snoop enable	Enable the ingress DHCP-snoop TCAM group
(config)#commit	Commit Candidate config to running-config
(config)#hardware-profile filter dhcp-snoop disable	Disable the ingress DHCP-snoop TCAM group
(config)#commit	Commit Candidate config to running-config

¹Dynamic Host Configuration Protocol

Enable/Disable the Ingress DHCP-snoop-IPv6 TCAM group

#configure terminal	Enter Configure mode.
(config)#hardware-profile filter dhcp-snoop-ipv6 enable	Enable the ingress DHCP-snoop-IPv6 TCAM group
(config)#commit	Commit Candidate config to running-config
(config)#hardware-profile filter dhcp-snoop-ipv6 disable	Disable the ingress DHCP-snoop-IPv6 TCAM group
(config)#commit	Commit Candidate config to running-config

Enable DHCP Snooping and DAI Globally

#configure terminal	Enter Configure mode.
(config)#bridge 1 protocol mstp	Create MSTP or IEEE VLAN-bridge.
(config)#ip dhcp snooping bridge 1	Enable DHCP Snooping on the bridge
(config)#ip dhcp snooping arp-inspection bridge 1	Enable DAI on bridge
(config)#commit	Commit Candidate config to running-config

Enable DHCP Snooping and DAI on a VLAN

#configure terminal	Enter Configure mode.
(config)#vlan 2 bridge 1	Configure a VLAN for the bridge.
(config)#ip dhcp snooping vlan 2 bridge 1	Enable DHCP Snooping on the VLAN 2
(config)#ip dhcp snooping arp-inspection vlan 2 bridge 1	Enable DAI on VLAN
(config)#commit	Commit Candidate config to running-config

Validation

```
OcNOS#show hardware-profile filters
```

Note: Shared count is the calculated number from available resources.
Dedicated count provides allocated resource to the group.
If group shares the dedicated resource with other groups, then dedicated count of group will reduce with every resource usage by other groups.

```
+-----+-----+-----+-----+-----+-----+
|          | Free  | Used  |          | Total Entries |
| Unit - TCAMS | Entries | % | Entries | Total | Dedicated | shared |
+-----+-----+-----+-----+-----+-----+
0 DHCP-SNOOP      5522   2   104   5626  1018   4608
0 DHCP-SNOOP-IPV6 5522   0    6   5528   920   4608
0 IPSPG           3327   0    1   3328  1024   2304
0 IPSPG-IPV6     3327   0    1   3328  1024   2304
```

Enable/Disable IP DHCP Snooping ARP-inspection Validate

Use this command to enable validation of the source-MAC, destination-MAC, or IP address field in the ARP packet payload.



Note: The IP address in a payload is validated for not being a broadcast address, a reserved zero IP address, and multicast address.

#configure terminal	Enter Configure mode.
(config)#ip dhcp snooping arp-inspection validate src-mac bridge 1	Enable SRC-MAC validate
(config)#commit	Commit Candidate config to running-config
(config)#no ip dhcp snooping arp-inspection validate src-mac bridge 1	Disable SRC-MAC validate
(config)#commit	Commit Candidate config to running-config
(config)#ip dhcp snooping arp-inspection validate dst-mac bridge 1	Enable DST-MAC validate
(config)#commit	Commit Candidate config to running-config
(config)#no ip dhcp snooping arp-inspection validate dst-mac bridge 1	Disable DST-MAC validate
(config)#commit	Commit Candidate config to running-config
(config)#ip dhcp snooping arp-inspection validate ip bridge 1	Enable IP validate
(config)#commit	Commit Candidate config to running-config
(config)#no ip dhcp snooping arp-inspection validate ip bridge 1	Disable IP validate
(config)#commit	Commit Candidate config to running-config

Configuring the Ports Connected to DHCP Server and DHCP Client

#configure terminal	Enter Configure mode.
(config)#interface xe1	Specify the interface xe1 to be configured, and Enter interface mode
(config-if)#switchport	Configure the interface as a switch port.
(config-if)#bridge-group 1	Associate the interface xe1 with bridge-group 1.
(config-if)#switchport mode access	Configure the port as an access port
(config-if)#switchport access vlan 2	Bind the interface VLAN 2 to the port
(config-if)#exit	Exit interface mode.

(config)#interface xe2	Specify interface xe2 to be configured connected to server.
(config-if)#switchport	Configure the interface as a switch port
(config-if)#bridge-group 1	Associate interface xe2 with bridge-group 1.
(config-if)#switchport mode access	Configure the port as an access port.
(config-if)#switchport access vlan 2	Bind the interface VLAN 2 to the port
(config-if)#exit	Exit the config mode.
(config)#commit	Commit Candidate config to running-config
(config)#exit	Exit the config mode.

Configuring Trusted and Un-trusted Ports

Usually the port connected to server is configured as trusted port and the ports connected to client is configured as un-trusted port.

In this example, xe2 is connected to the **DHCP client**¹ and xe1 is connected to the DHCP server.

- Configure xe2 connected to DHCP client as un-trusted port.
- Configure xe1 connected to the DHCP server as trusted port.

#configure terminal	Enter Configure mode.
(config)#interface xe1	Specify the interface to be configured
(config-if)#ip dhcp snooping trust	Enable the port as trusted.
(config)#commit	Commit Candidate config to running-config
(config)#interface xe2	Specify the interface to be configured
(config-if)#no ip dhcp snooping trust	Disable the port as trusted.
(config-if)#exit	Exit interface mode
(config)#commit	Commit Candidate config to running-config

Validation

```
OcNOS#show ip dhcp snooping arp-inspection statistics bridge 1
bridge      forwarded  dai dropped
-----
1           0          10
```

¹A DHCP client is a hardware device or software that uses DHCP to get the network configuration information from a DHCP Server. VRF: VRF creates a logically isolated routing table within a single physical network device. Each VRF instance works as an independent routing instance that enables separate network traffic, maintains different routing tables, and provides network isolation.

Proxy ARP and Local Proxy ARP

Overview

Proxy ARP (RFC 1027) is a technique by which a device on a given network answers the ARP queries for a network address that is not on that network. The Proxy ARP is aware of the location of the traffic's destination, and offers its own MAC address as destination. The captured traffic is then typically routed by the Proxy to the intended destination via another interface. Proxy ARP can help machines on a subnet reach remote subnets without the need to configure routing or a default gateway.

Use `no ip proxy-arp` to disable Proxy ARP, Proxy ARP is disabled by default.

Topology

Figure 67. Sample topology

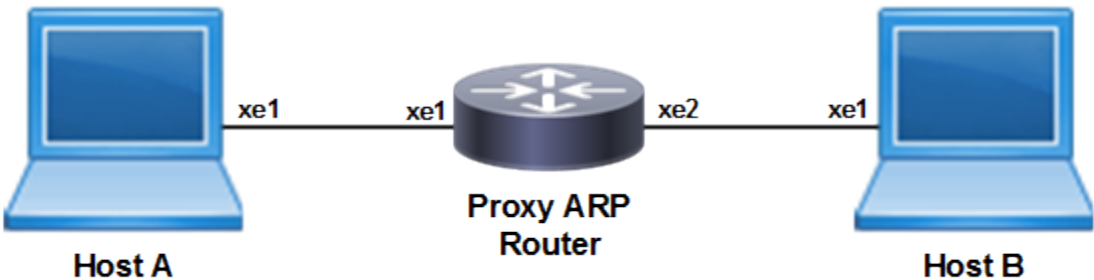

Host A

Table 74.

<code>#configure terminal</code>	Enter Configure mode.
<code>(config)#interface xe1</code>	Specify the interface to be configured on Host A
<code>(config-if)#ip address 20.20.0.3/24</code>	Configure the ip address on the interface
<code>(config)#commit</code>	Commit the candidate configuration to the running configuration
<code>(config)#end</code>	Exit interface and configure mode

Host B

<code>#configure terminal</code>	Enter Configure mode
<code>(config)#interface xe1</code>	Specify the interface to be configured on Host B
<code>(config-if)#ip address 20.20.1.2/24</code>	Configure the ip address on the interface

<code>(config)#commit</code>	Commit the candidate configuration to the running configuration
<code>(config)#end</code>	Exit interface and configure mode

Enable Proxy ARP

<code>#configure terminal</code>	Enter Configure mode.
<code>(config)#interface xe1</code>	Specify the interface connected to Host A
<code>(config-if)#ip address 20.20.0.1/24</code>	Configure the ip address on the interface
<code>(config-if)#interface xe2</code>	Specify the interface connected to Host B
<code>(config-if)#ip address 20.20.1.1/24</code>	Configure the ip address on the interface
<code>(config-if)#interface xe1</code>	Specify the interface to configure Proxy ARP
<code>(config-if)#ip proxy-arp</code>	Enable Proxy ARP
<code>(config)#commit</code>	Commit the candidate configuration to the running configuration
<code>(config)#end</code>	Exit interface and configure mode

Validation

```
#show running-config arp
!
interface xe1
ip proxy-arp
!
```

The **show arp** command on the hosts shows the ARP table entries to reach different subnets. Ping Host A from Host B. The ARP table should have the router's xe1 interface MAC address to reach Host A. Execute the below command at Host B:

```
#show arp

Flags: D - Static Adjacencies attached to down interface

IP ARP Table for context default
Total number of entries: 2
Address      Age          MAC Address  Interface  State
20.20.0.3    00:02:39    ecf4.bbc0.3d71  xe1        STALE.
```

Local Proxy ARP Overview

Local Proxy ARP feature is used to enable local proxy support for ARP requests per interface level. Activation will make the router answer all ARP requests on configured subnet, even for clients that should not normally need routing. Local proxy ARP means that the traffic comes in and goes out the same interface.

The local proxy ARP feature allows responding to ARP requests for IP addresses within a subnet where normally no routing is required. With the local proxy ARP feature enabled, ARP responds to all ARP requests for IP addresses within the subnet and forwards all traffic between hosts in the subnet. Use this feature only on subnets where hosts are intentionally prevented from communicating directly.

Topology

Figure 68. Sample topology

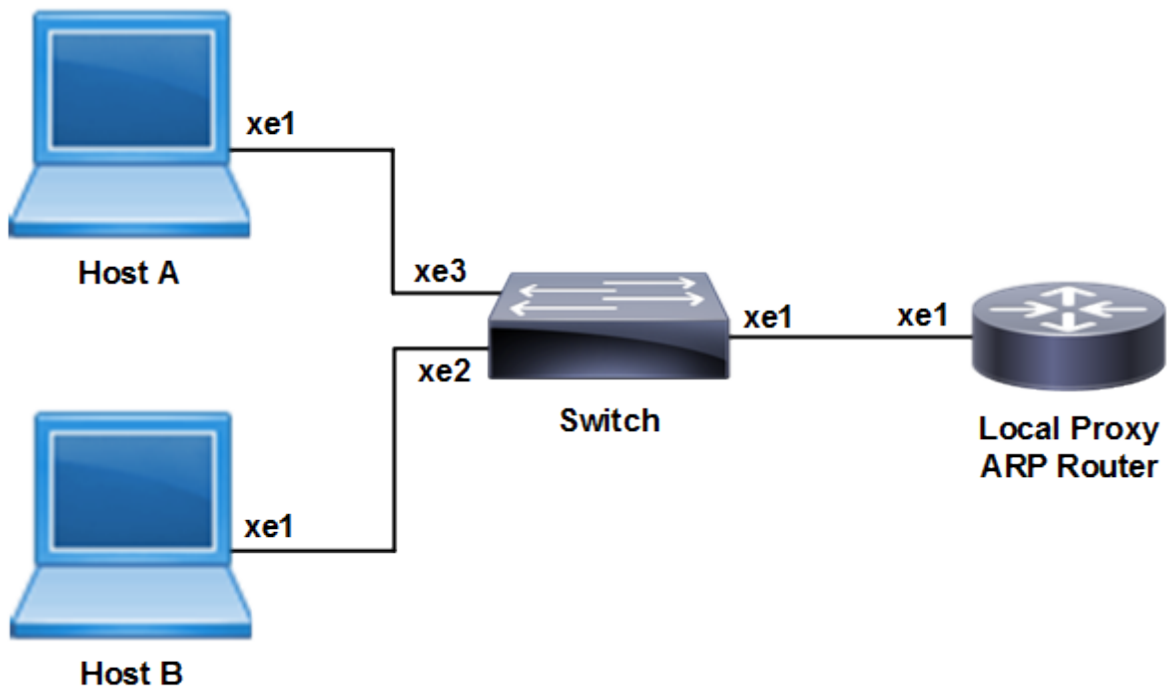

Host A

#configure terminal	Enter Configure mode.
(config)#interface xe1	Specify the interface to be configured on Host A
(config-if)#ip address 20.20.0.2/24	Configure the ip address on the interface
(config)#commit	Commit the candidate configuration to the running configuration
(config)#end	Exit interface and configure mode

Host B

#configure terminal	Enter Configure mode
(config)#interface xe1	Specify the interface to be configured on Host B
(config-if)#ip address 20.20.0.3/24	Configure the ip address on the interface
(config)#commit	Commit the candidate configuration to the running configuration
(config)#end	Exit interface and configure mode

Private Vlan Configuration on Switch

#configure terminal	Enter Configure mode.
(config)#bridge 1 protocol ieee vlan-bridge	Create ieee vlan-bridge on switch for pvlan configuration
(config)#vlan database	Enter into the vlan database
(config-vlan)#vlan 100-101 bridge 1 state enable	Create vlans 100 and 101 as part of bridge 1
(config-vlan)#private-vlan 100 primary bridge 1	Configure vlan 100 as a primary vlan
(config-vlan)#private-vlan 101 isolated bridge 1	Configure vlan 101 as a isolated vlan
(config-vlan)#private-vlan 100 association add 101 bridge 1	Associate secondary vlan 101 to primary vlan 100
(config-vlan)#exit	Exit from the vlan database
(config)#commit	Commit the candidate configuration to the running configuration
(config)#interface xe1	Specify the interface to be configured
(config-if)#switchport	Configure xe1 as a layer2 interface.
(config-if)#bridge-group 1	Associate the interface to the bridge
(config-if)#switchport access vlan 100	Associate primary vlan to the interface
(config-if)#switchport mode private-vlan promiscuous	Configure xe1 interface as a promiscuous port
(config-if)#switchport private-vlan mapping 100 add 101	Associate primary vlan 100 and secondary vlan 101 to a promiscuous port
(config-if)#exit	Exit interface mode
(config)#commit	Commit the candidate configuration to the running configuration
(config)#interface xe2	Specify the interface to be configured
(config-if)#switchport	Configure xe2 as a layer2 interface.
(config-if)#bridge-group 1	Associate the interface to the bridge
(config-if)#switchport access vlan 100	Associate primary vlan to the interface
(config-if)#switchport mode private-vlan promiscuous	Configure xe2 interface as a promiscuous

	port
(config-if)#switchport private-vlan mapping 100 add 101	Associate primary vlan 100 and secondary vlan 101 to a promiscuous port
(config-if)#exit	Exit interface mode
(config)#commit	Commit the candidate configuration to the running configuration
(config)#interface xe3	Specify the interface to be configured
(config-if)#switchport	Configure xe3 as a layer2 interface.
(config-if)#bridge-group 1	Associate the interface to the bridge
(config-if)#switchport access vlan 100	Associate primary VLAN to the interface
(config-if)#switchport mode private-vlan promiscuous	Configure xe2 interface as a promiscuous port
(config-if)#switchport private-vlan mapping 100 add 101	Associate primary vlan 100 and secondary vlan 101 to a promiscuous port
(config-if)#exit	Exit interface mode
(config)#commit	Commit the candidate configuration to the running configuration

Enable Local Proxy ARP on Router

#configure terminal	Enter Configure mode
(config)#interface xe1	Specify the interface to be configured on Host B
(config-if)#ip address 20.20.0.3/24	Configure the ip address on the interface
(config-if)#ip local-proxy-arp	Enable Local Proxy ARP
(config)#commit	Commit the candidate configuration to the running configuration
(config)#end	Exit interface and configure mode

Validation

ARP cache on Host A and Host B

The **show arp** command on hosts shows the arp table entries to reach different subnets. Ping Host B from Host A. Host A ARP table should have Router's xe1 interface MAC address to reach Host B. Execute the below command at Host A.

```
#show arp

Flags: D - Static Adjacencies attached to down interface

IP ARP Table for context default
Total number of entries: 2
Address      Age          MAC Address  Interface  State
20.20.0.3   00:02:39    ecf4.bbc0.3d71  xe1        STALE.
```

DHCP Snooping

Overview

DHCP¹ snooping is a series of techniques applied to ensure the security of an existing DHCP infrastructure. It is a security feature that acts like a fire wall between untrusted hosts and trusted DHCP servers. It is a layer-2 security technology built into the operating system of a capable network switch that drops DHCP traffic determined to be unacceptable.

The fundamental use case of DHCP snooping is to prevent unauthorized (rogue) DHCP servers offering IP addresses to DHCP clients. Rogue DHCP servers are often used in 'man-in the middle' or 'Denial of Service' attacks from malicious purpose. Similarly DHCP clients (rogue) can also cause 'Denial of Service' attacks by continuously requesting for IP addresses causing address depletion in the DHCP server.

The DHCP snooping feature performs the following activities:

- Validates DHCP messages received from un-trusted sources and filters out invalid messages.
- Rate-limits DHCP traffic from trusted and un-trusted sources.
- Builds and maintains the DHCP snooping binding database, which contains information about un-trusted hosts with leased IP addresses.
- Utilizes the DHCP snooping binding database to validate subsequent requests from un-trusted hosts.
- To retain the DHCP snooping bindings database across reloads, it is stored in a persistent file on switch itself. Upon reload, the switch restores binding database from the persistent file. On NTP sync, the lease time of the binding entries gets re-adjusted based on the timestamp that was written in the persistent file. The switch keeps the file updated by writing to the file periodically (default interval 300 seconds). **Note:** To ensure the accuracy of lease time adjustment, NTP should be configured on the snooper.
- When DHCP snooping is used over MLAG, the DHCP snooping binding database syncing will be happening among the peers via IDL.

DHCP snooping with provider bridge is not supported.

DHCP snooping is enabled on a per-VLAN basis. By default, the feature is inactive on all VLANs. You can enable the feature on a single VLAN or a range of VLANs.

¹Dynamic Host Configuration Protocol

Topology

Figure 69. DHCP Snooping topology

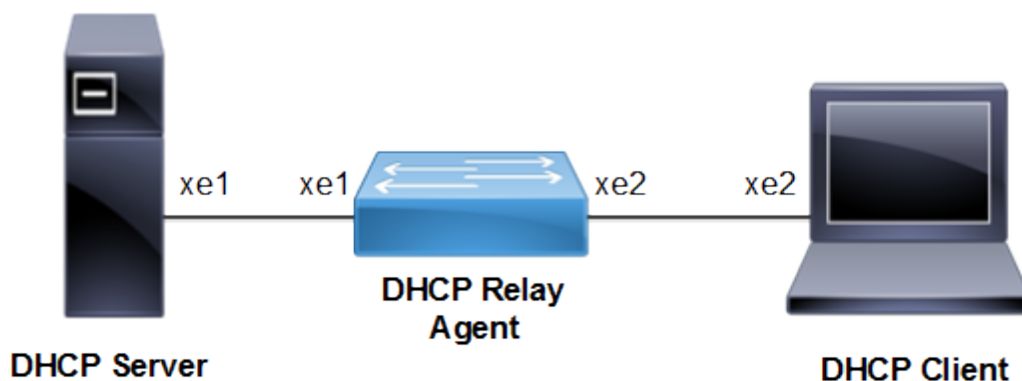

Configuration

When configuring DHCP snooping, follow these guidelines:

- DHCP snooping is not active until you enable the feature on at least one VLAN, and enable DHCP snooping globally on the switch.
- Before globally enabling DHCP snooping on the switch, make sure that the device acting as the DHCP server is configured and enabled.
- If a Layer 2 LAN port is connected to a DHCP server, configure the port as trusted by entering the `ip dhcp snooping trust interface` configuration command.
- If a Layer 2 LAN port is connected to a **DHCP client**¹, configure the port as un-trusted by entering the `no ip dhcp snooping trust` interface configuration command.

Procedures

The following subsections provide examples of how to enable and configure DHCP Snooping.

Enable DHCP Snooping Globally

<code>#configure terminal</code>	Enter Configure mode.
<code>(config)#bridge 1 protocol mstp</code>	Create MSTP or IEEE VLAN-bridge.
<code>(config)#ip dhcp snooping bridge 1</code>	Enable DHCP Snooping on the bridge
<code>(config)#commit</code>	Commit Candidate config to running-config

¹A DHCP client is a hardware device or software that uses DHCP to get the network configuration information from a DHCP Server. VRF: VRF creates a logically isolated routing table within a single physical network device. Each VRF instance works as an independent routing instance that enables separate network traffic, maintains different routing tables, and provides network isolation.

Enable DHCP Snooping on a VLAN

#configure terminal	Enter Configure mode.
(config)#vlan 2 bridge 1	Configure a VLAN for the bridge.
(config)#ip dhcp snooping vlan 2 bridge 1	Enable DHCP Snooping on the VLAN 2
(config)#commit	Commit Candidate config to running-config

Validation

```
OcNOS#show hardware-profile filters
```

Note: Shared count is the calculated number from available resources.
 Dedicated count provides allocated resource to the group.
 If group shares the dedicated resource with other groups, then dedicated count of group will reduce with every resource usage by other groups.

Unit - TCAMS	Free Entries	Used %	Used Entries	Total	Dedicated	shared
0 DHCP-SNOOP	9717	0	5	9722	1018	8704
0 DHCP-SNOOP-IPV6	9717	0	6	9723	1019	8704

Configuring the Ports Connected to DHCP Server and DHCP Client

#configure terminal	Enter Configure mode.
(config)#interface xe1	Specify the interface xe1 to be configured, and Enter interface mode
(config-if)#switchport	Configure the interface as a switch port.
(config-if)#bridge-group 1	Associate the interface xe1 with bridge-group 1.
(config-if)#switchport mode access	Configure the port as an access port
(config-if)#switchport access vlan 2	Bind the interface VLAN 2 to the port
(config-if)#exit	Exit interface mode.
(config)#interface xe2	Specify interface xe2 to be configured connected to server.
(config-if)#switchport	Configure the interface as a switch port
(config-if)#bridge-group 1	Associate interface xe2 with bridge-group 1.
(config-if)#switchport mode access	Configure the port as an access port.
(config-if)#switchport access vlan 2	Bind the interface VLAN 2 to the port
(config-if)#exit	Exit the config mode.
(config)#commit	Commit Candidate config to running-config
(config)#exit	Exit the config mode.

Configuring Trusted and Un-trusted Ports

Usually the port connected to server is configured as trusted port and the ports connected to client is configured as un-trusted port.

In this example, xe2 is connected to the **DHCP client**¹ and xe1 is connected to the **DHCP**² server.

- Configure xe2 connected to DHCP client as un-trusted port.
- Configure xe1 connected to the DHCP server as trusted port.

#configure terminal	Enter Configure mode.
(config)#interface xe1	Specify the interface to be configured
(config-if)#ip dhcp snooping trust	Enable the port as trusted.
(config)#commit	Commit Candidate config to running-config
(config)#interface xe2	Specify the interface to be configured
(config-if)#no ip dhcp snooping trust	Disable the port as trusted.
(config-if)#exit	Exit interface mode
(config)#commit	Commit Candidate config to running-config

¹A DHCP client is a hardware device or software that uses DHCP to get the network configuration information from a DHCP Server. VRF: VRF creates a logically isolated routing table within a single physical network device. Each VRF instance works as an independent routing instance that enables separate network traffic, maintains different routing tables, and provides network isolation.

²Dynamic Host Configuration Protocol

IDHCP Snooping Operation

1. Configure **DHCP**¹ server that is connected to DHCP Snooper through trusted port.
2. Request an IP address from the **DHCP client**² connected through the un-trusted port.
3. DHCP client broadcast the DHCP DISCOVER message to the switch.
4. DHCP server responds to the DHCP DISCOVER message with DHCP offer message to the client.
5. Once the DHCP OFFER is received by the client, it sends an DHCP REQUEST to the server.
6. DHCP server validates the request from the client and sends DHCP ACK with the offered IP address to the client with the lease time.
7. DHCP Snooper creates an entry for the above operation into the binding table which includes the MAC address of the host, the leased IP address, the lease time, the binding type, and the VLAN number and interface information associated with the host.
8. DHCP Snooper clears the entry in the binding table once the client sends the DHCP RELEASE query or lease time is expired.



Note: On snooper once lease time becomes 0 for an entry, it is removed from the bind table within 10 sec.

Validation

The **show running-config ip dhcp snooping** command displays the DHCP snooping commands configured on the device in question.

```
#show running-config ip dhcp snooping
!
!
ip dhcp snooping bridge 1
ip dhcp snooping vlan 2 bridge 1
interface xe1
  ip dhcp snooping trust
!
```

The **show ip dhcp snooping bridge 1** command displays the configured information about DHCP Snooping.

```
#show ip dhcp snooping bridge 1

Bridge Group : 1
DHCP snooping is : Enabled
DHCP snooping option82 is : Disabled
Verification of hwaddr field is : Disabled
Strict validation of DHCP packet is : Disabled
Rate limit(pps) : 100
DHCP snooping is configured on following VLANs : 2
DHCP snooping is operational on following VLANs : 2
```

¹Dynamic Host Configuration Protocol

²A DHCP client is a hardware device or software that uses DHCP to get the network configuration information from a DHCP Server. VRF: VRF creates a logically isolated routing table within a single physical network device. Each VRF instance works as an independent routing instance that enables separate network traffic, maintains different routing tables, and provides network isolation.

DHCP snooping IP Source Guard is configured on the following Interface

Interface	Trusted
-----	-----
xe2	Yes

The **show ip dhcp snooping binding bridge 1** command displays the binding table entries associated with un-trusted interfaces.

```
#show ip dhcp snooping bridge 1

Bridge Group : 1
DHCP snooping is : Enabled
DHCP snooping option82 is : Disabled
Verification of hwaddr field is : Disabled
Strict validation of DHCP packet is : Disabled
Rate limit(pps) : 100
DHCP snooping is configured on following VLANs : 2
DHCP snooping is operational on following VLANs : 2
DHCP snooping trust is configured on the following Interfaces
Interface Trusted
-----
xe1         Yes
```

DHCP snooping IP Source Guard is configured on the following Interfaces.

Interface	Source Guard
-----	-----

DHCP Snooping with Option-82

When **DHCP**¹ snooping with Option-82 is enabled on the switch, following behavior is expected:

1. The host generates a DHCP request and broadcasts it on the network.
2. When the switch receives DHCP request, it adds option-82 information in the packet.
3. If the IP address of the relay agent is configured, the switch adds the IP address in the DHCP packet.
4. The switch forwards the DHCP request that includes the option-82 field to the DHCP server.
5. The DHCP server receives the packet. If the server is option-82 capable, it can use the information in the option-82 fields to assign IP addresses and implement policies, such as restricting the number of IP addresses that can be assigned to a single remote ID or circuit ID. The DHCP server then echoes the option-82 field in the DHCP reply.
6. The DHCP server unicasts the reply to the switch if the request was relayed to the server by the switch. When the client and server are on the same subnet, the server broadcasts the reply. The switch verifies that it originally inserted the option-82 data by inspecting the remote id and circuit id fields. The switch removes the option-82 field and forwards the packet to the switch port that connects to **DHCP client**² that sent the DHCP request.

¹Dynamic Host Configuration Protocol

²A DHCP client is a hardware device or software that uses DHCP to get the network configuration information from a DHCP Server. VRF: VRF creates a logically isolated routing table within a single physical network device. Each VRF instance works as an independent routing instance that enables separate network traffic, maintains different routing tables, and provides network isolation.

Procedures

The following subsections provide examples of how to configure **DHCP**¹ snooping with option-82.

The topology is the same as [Figure 69](#).

Enable DHCP Snooping Globally

#configure terminal	Enter configure mode.
(config)#bridge 1 protocol mstp	Create mstp or ieee vlan-bridge.
(config)#ip dhcp snooping bridge 1	Enable DHCP Snooping on the bridge

Enable DHCP Snooping on a VLAN

configure terminal	Enter configure mode.
(config)#vlan 2 bridge 1	Configure a vlan for the bridge.
(config)#ip dhcp snooping vlan 2 bridge 1	Enable DHCP Snooping on the vlan 2

Configure Ports connected to DHCP Server and DHCP Client

#configure terminal	Enter the configure mode
(config)#interface xe1	Specify the interface xe1 to be configured, connected to client and Enter interface mode
(config-if)#switchport	Configure the interface as a switch port.
(config-if)#bridge-group 1	Associate the interface xe1 with bridge-group 1.
(config-if)#switchport mode access	Configure the port as an access port
(config-if)#switchport access vlan 2	Bind the interface vlan 2 to the port.
(config-if)#exit	Exit interface mode.
(config)#interface xe2	Specify interface xe2 to be configured connected to server.
(config-if)#switchport	Configure the interface as a switch port.
(config-if)#bridge-group 1	Associate interface xe2 with bridge-group 1.
(config-if)#switchport mode access	Configure the port as an access port.
(config-if)#switchport access vlan 2	Bind the interface vlan 2 to the port.
(config-if)#exit	Exit interface mode.
(config)#exit	Exit the config mode.

Configure Trusted and Untrusted Ports

Usually the port connected to server is configured as trusted port and the ports connected to client is configured as untrusted port

¹Dynamic Host Configuration Protocol

In this example, xe1 is connected to the **DHCP client**¹ and xe2 is connected to the DHCP server.

- Configure xe1 connected to DHCP client as un-trusted port.
- Configure xe2 connected to the DHCP server as trusted port.

#configure terminal	Enter configure mode.
(config)#interface xe1	Specify the interface to be configured
(config-if)#no ip dhcp snooping trust	Disable the port as trusted.
#configure terminal	Enter configure mode.
(config)#interface xe2	Specify the interface to be configured
(config-if)#ip dhcp snooping trust	Enable the port as trusted.

Enable option-82

#configure terminal	Enter configure mode.
(config)# ip dhcp snooping information option bridge 1	Configure DHCP snooping information option-82

¹A DHCP client is a hardware device or software that uses DHCP to get the network configuration information from a DHCP Server. VRF: VRF creates a logically isolated routing table within a single physical network device. Each VRF instance works as an independent routing instance that enables separate network traffic, maintains different routing tables, and provides network isolation.

Validation

The **show running-config ip dhcp snooping** command displays the **DHCP**¹ snooping commands configured on the device in question.

```
#show running-config ip dhcp snooping
!
!
ip dhcp snooping bridge 1
ip dhcp snooping vlan 2 bridge 1
interface xe2
ip dhcp snooping trust
!
```

The **show ip dhcp snooping bridge 1** command displays the configured information about DHCP Snooping.

```
Bridge Group                : 1
DHCP snooping is           : Enabled
DHCP snooping option82 is  : Disabled
Verification of hwaddr field is : Disabled
Strict validation of DHCP packet is : Disabled
Rate limit(pps)            : 200
DB Write Interval(secs)    : 300
DHCP snooping is configured on following VLANs : 2
DHCP snooping is operational on following VLANs : 2
```

DHCP snooping IP Source Guard is configured on the following Interface

Interface	Trusted
-----	-----
xe2	Yes

The **show ip dhcp snooping binding bridge 1** command displays the binding table entries associated with un-trusted interfaces.

```
#show ip dhcp snooping bridge 1

Bridge Group                : 1
DHCP snooping is           : Enabled
DHCP snooping option82 is  : Disabled
Verification of hwaddr field is : Disabled
Strict validation of DHCP packet is : Disabled
Rate limit(pps)            : 200
DB Write Interval(secs)    : 300
DHCP snooping is configured on following VLANs : 2
DHCP snooping is operational on following VLANs : 2
```

DHCP snooping trust is configured on the following Interfaces.

Interface	Trusted
-----	-----
xe2	Yes

DHCP snooping IP Source Guard is configured on the following Interfaces.

Interface	Source Guard
-----	-----

¹Dynamic Host Configuration Protocol

```
#show ip dhcp snooping binding bridge 1
```

```
Total number of static IPV4 entries      : 0
Total number of dynamic IPV4 entries     : 1
Total number of static IPV6 entries      : 0
Total number of dynamic IPV6 entries     : 0
```

MacAddress	IpAddress	Lease (sec)	Type	VLAN	Interface
-----	-----	-----	-----	-----	-----

6400.6afc.3ba1	192.168.1.2	600	dhcp-snooping	2	xe1

Sample server dhcpd.conf for option-82

This example shows a server `dhcpd.conf` file for option-82 with `remote-id` and `circuit-id` suboptions.

```
Remote-id :
class "remote-id" {
match if option agent.remote-id = cc:37:ab:56:6d:80;--->Points to Snooping switch eth0 Mac address.
} # remote-id
subnet 192.168.1.0 netmask 255.255.255.0 {
pool {
option subnet-mask 255.255.255.0;
allow members of "remote-id";
range 192.168.1.2 192.168.1.100;
default-lease-time 600;
max-lease-time 600;
option subnet-mask 255.255.255.0;
option domain-name "Domain1.com";
option domain-name-servers 23.32.23.32,4.4.4.2;
option ntp-servers 19.91.19.91,45.54.45.54,localhost1,19.91.19.91;
option log-servers 10.12.16.17,10.12.16.16;
option bootfile-name "Bootfile1";
option tftp-server-name "Tftpserver1";
option host-name "Omega";
}
}

Circuit-id:

class "circuit-id" {
match if option agent.circuit-id = 00:00:13:b6:00:02;---->Points to vlan and interface index value.
} # circuit-id

subnet 192.168.1.0 netmask 255.255.255.0 {
pool {
option subnet-mask 255.255.255.0;
allow members of "circuit-id";
range 192.168.1.2 192.168.1.100;
default-lease-time 600;
max-lease-time 600;
option subnet-mask 255.255.255.0;
option domain-name "Domain1.com";
option domain-name-servers 23.32.23.32,4.4.4.2;
option ntp-servers 19.91.19.91,45.54.45.54,localhost1,19.91.19.91;
option log-servers 10.12.16.17,10.12.16.16;
option bootfile-name "Bootfile1";
option tftp-server-name "Tftpserver1";
option host-name "Omega";
}
}
```

DHCP Snooping IP Source Guard

Overview

IPSG is a security feature that restricts IP traffic on non-routed, Layer 2 interfaces by filtering traffic based on the **DHCP**¹ snooping binding database. Use IP source guard to prevent traffic attacks if a host tries to use the IP address of its neighbor. Enable IP source guard when DHCP snooping is enabled on an untrusted interface. After IPSG is enabled on an interface, the switch blocks all IP traffic received on the interface except for DHCP packets allowed by DHCP snooping. A port access control list (ACL) is applied to the interface. The port ACL allows only IP traffic with a source IP address in the IP DHCP snooping binding table and denies all other traffic.

Topology

Figure 70. IP Source Guard Topology

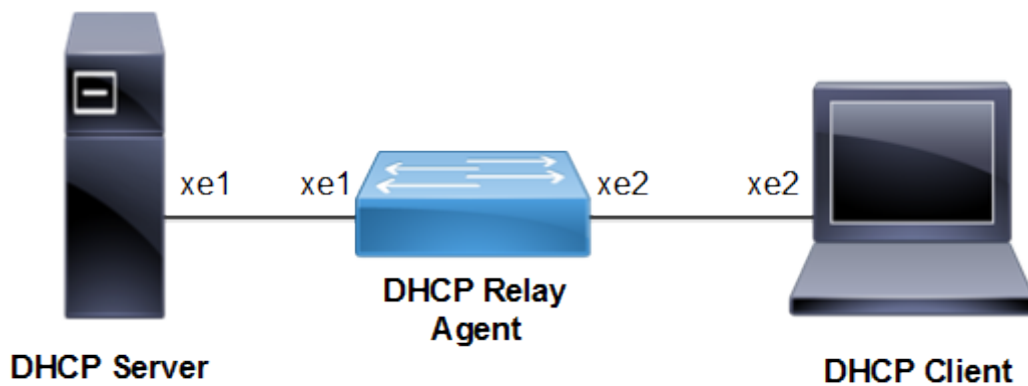

¹Dynamic Host Configuration Protocol

Configuring the Ports Connected to DHCP Server and DHCP Client

#configure terminal	Enter Configure mode.
(config)#bridge 1 protocol ieee vlan-bridge	Create IEEE VLAN bridge 1.
(config)#vlan 2 bridge 1 state enable	Create VLAN 2
(config)#ip dhcp snooping bridge 1	Configure DHCP ¹ snooping for bridge 1
(config)#ip dhcp snooping information option bridge 1	Configure DHCP snooping information option 82
(config)#ip dhcp snooping vlan 2 bridge 1	Configure DHCP snooping for VLAN 2 for bridge 1
(config)#ip dhcp snooping verify mac-address bridge 1	Configure DHCP snooping verify MAC-address
(config)#interface xe1	Enter Interface Mode
(config-if)#switchport	Configure the interface as Layer 2
(config-if)#bridge-group 1	Associate the interface with bridge group 1.
(config-if)#switchport mode access	Set the Layer2 interface as Access. (It can be Trunk mode also)
(config-if)#switchport access vlan 2	Set the default VLAN for the interface
(config-if)#ip dhcp snooping trust	Configuring the interface as Trust. Basically this is configured on the interface which is connected to Server Side.
(config-if)#exit	Exit interface mode.
(config)#interface xe2	Enter Interface Mode
(config-if)#switchport	Configure the interface as Layer 2
(config-if)#bridge-group 1	Associate the interface with bridge group 1.
(config-if)#switchport mode access	Set the Layer2 interface as Access. (It can be Trunk mode also)
(config-if)#switchport access vlan 2	Set the default VLAN for the interface
(config-if)#ip verify source dhcp-snooping-vlan	Configuring IP source guard at Interface level and configured on the interface which is connected to client side
(config-if)#ip verify source access-group mode merge	Merge IPSG policy with other ACL
(config-if)#exit	Exit interface mode
(config)#ip dhcp snooping binding bridge 1 0011.1111.2222 2 ipv4 1.1.1.1 xe2	Configure IPv4 Static Entry For DHCP snooping with MAC address and Source Address for an interface and VLAN configured
(config)#ip dhcp snooping binding bridge 1	Configure IPv6 Static Entry For DHCP snooping with

¹Dynamic Host Configuration Protocol

0022.2222.3333 2 ipv6 3ffe::1 xe2	MAC address and Source Address for an interface and VLAN configured
(config)#commit	Commit Candidate config to running-config
(config)#exit	Exit config mode
#clear ip dhcp snooping binding bridge 1	Clear DHCP binding tables which are learned dynamically

Validation

Verify that DHCP snooping is enabled on the bridge:

```
#sh ip dhcp snooping bridge 1
Bridge Group : 1
DHCP snooping is : Enabled
DHCP snooping option82 is : Enabled
Verification of hwaddr field is : Enabled
DHCP snooping is configured on following VLANs : 2
DHCP snooping is operational on following VLANs : 2
DHCP snooping trust is configured on the following Interfaces
Interface      Trusted
-----
xe1             Yes
```

DHCP snooping IP Source Guard is configured on the following Interfaces.

```
Interface      Source Guard
-----
xe2             Yes
```

Configuring Trusted and Un-trusted Ports

Usually the port connected to server is configured as trusted port and the ports connected to client is configured as un-trusted port.

In this example, xe2 is connected to the **DHCP client**¹ and xe1 is connected to the **DHCP**² server.

- Configure xe2 connected to DHCP client as un-trusted port.
- Configure xe1 connected to the DHCP server as trusted port.

#configure terminal	Enter Configure mode.
(config)#interface xe1	Specify the interface to be configured
(config-if)#ip dhcp snooping trust	Enable the port as trusted.
(config)#commit	Commit Candidate config to running-config
(config)#interface xe2	Specify the interface to be configured
(config-if)#no ip dhcp snooping trust	Disable the port as trusted.
(config-if)#exit	Exit interface mode
(config)#commit	Commit Candidate config to running-config

Validation

Verify that static DHCP snooping entries are configured for the bridge:

```
#sh ip dhcp snooping binding bridge 1
Total number of static IPV4 entries : 1
Total number of dynamic IPV4 entries : 0
Total number of static IPV6 entries : 1
Total number of dynamic IPV6 entries : 0
```

MacAddress	IpAddress	Lease(sec)	Type	VLAN	Interface
0011.1111.2222	1.1.1.1	0	static	2	xe2
0022.2222.3333	3ffe::1	0	static	2	xe2

¹A DHCP client is a hardware device or software that uses DHCP to get the network configuration information from a DHCP Server. VRF: VRF creates a logically isolated routing table within a single physical network device. Each VRF instance works as an independent routing instance that enables separate network traffic, maintains different routing tables, and provides network isolation.

²Dynamic Host Configuration Protocol

Configuring IP Source Guard on LAG Port

In this example, the **LAG¹** port (sa2) is created, then physical interfaces are added.

#configure terminal	Enter Configure mode.
(config)#bridge 1 protocol ieee vlan-bridge	Create IEEE VLAN bridge 1.
(config)#vlan 2 bridge 1 state enable	Create VLAN 2
(config)#ip dhcp snooping bridge 1	Configure DHCP² snooping for bridge 1
(config)#ip dhcp snooping information option bridge 1	Configure DHCP snooping information option 82
(config)#ip dhcp snooping vlan 2 bridge 1	Configure DHCP snooping for VLAN 2 for bridge 1
(config)#ip dhcp snooping verify mac-address bridge 1	Configure DHCP snooping verify MAC-address
(config)#interface sa2	Enter Interface Mode
(config-if)#switchport	Configure the interface as Layer 2
(config-if)#bridge-group 1	Associate the interface with bridge group 1.
(config-if)#ip verify source dhcp-snooping-vlan	Configuring IP source guard at Interface level and configured on the interface which is connected to client side
(config-if)#ip verify source access-group mode merge	Merge IPSG policy with other ACL
(config-if)#exit	Exit interface mode
(config)#interface xe1	Enter Interface Mode
(config-if)#switchport	Configure the interface as Layer 2
(config-if)#bridge-group 1	Associate the interface with bridge group 1.
(config-if)#switchport mode access	Set the Layer2 interface as Access. (It can be Trunk mode also)
(config-if)#switchport access vlan 2	Set the default VLAN for the interface
(config-if)#ip dhcp snooping trust	Configuring the interface as Trust. Basically this is configured on the interface which is connected to Server Side.
(config-if)#exit	Exit interface mode.
(config)#interface xe2	Enter Interface Mode
(config-if)#switchport	Configure the interface as Layer 2
(config-if)#bridge-group 1	Associate the interface with bridge group 1.
(config-if)#switchport mode access	Set the Layer2 interface as Access. (It can be Trunk mode also)

¹Link Aggregation Group

²Dynamic Host Configuration Protocol

(config-if)#switchport access vlan 2	Set the default VLAN for the interface
(config-if)#static-channel-group 2	Configure Static Channel LAG on the interface
(config-if)#exit	Exit interface mode
(config)#ip dhcp snooping binding bridge 1 0011.1111.2222 2 ipv4 1.1.1.1 xe1	Configure IPv4 Static Entry For DHCP snooping with MAC address and Source Address for an interface and VLAN configured
(config)#ip dhcp snooping binding bridge 1 0022.2222.3333 2 ipv6 3ffe::1 xe2	Configure IPv6 Static Entry For DHCP snooping with MAC address and Source Address for an interface and VLAN configured
(config)#commit	Commit Candidate config to running-config
(config)#exit	Exit config mode
#clear ip dhcp snooping binding bridge 1	Clear DHCP binding tables which are learned dynamically

Validation

Verify that DHCP snooping is enabled on the bridge with the static LAG interface:

```
#sh ip dhcp snooping bridge 1
Bridge Group : 1
DHCP snooping is : Enabled
DHCP snooping option82 is : Enabled
Verification of hwaddr field is : Enabled
DHCP snooping is configured on following VLANs : 2
DHCP snooping is operational on following VLANs : 2
```

DHCP snooping IP Source Guard is configured on the following Interfaces

```
Interface      Source Guard
-----
sa2            Yes
```

Verify that static DHCP snooping or source guard entries are configured for the bridge with the LAG interface:

```
#sh ip dhcp snooping binding bridge 1
Total number of static IPV4 entries : 1
Total number of dynamic IPV4 entries : 0
Total number of static IPV6 entries : 1
Total number of dynamic IPV6 entries : 0
MacAddress      IPAddress      Lease(sec)  Type           VLAN  Interface
-----
0011.1111.2222  1.1.1.1       0           static         2    sa2
0022.2222.3333  3ffe::1       0           static         2    sa2
```

DHCP Snooping over MLAG

Overview

DHCP¹ snooping is a security feature that acts like a firewall between untrusted hosts and trusted DHCP servers. It is a layer-2 security technology built into the operating system of a capable network switch that drops DHCP traffic determined to be unacceptable. With DHCP snooping, the physical location of hosts can be tracked, only the IP addresses assigned for the hosts can be used, only the authorized DHCP servers are accessible. DHCP snooping can prevent attackers from adding their own DHCP servers to the network. DHCP snooping allows only clients with specific IP/MAC addresses to have access to the network.

The DHCP snooping over MLAG feature synchronizes the DHCP snooping binding database between the MLAG peers. If one of the MLAG peer node or MLAG link is down, the DHCP request / reply messages should be honoured by the partner.

DHCP snooping is supported over Active-Active MLAG mode using Static & Dynamic Channel group while Active-Standby MLAG mode using Static Channel group.

¹Dynamic Host Configuration Protocol

Configuration

Topology

Figure 71. DHCP¹ Snooping over MLAG

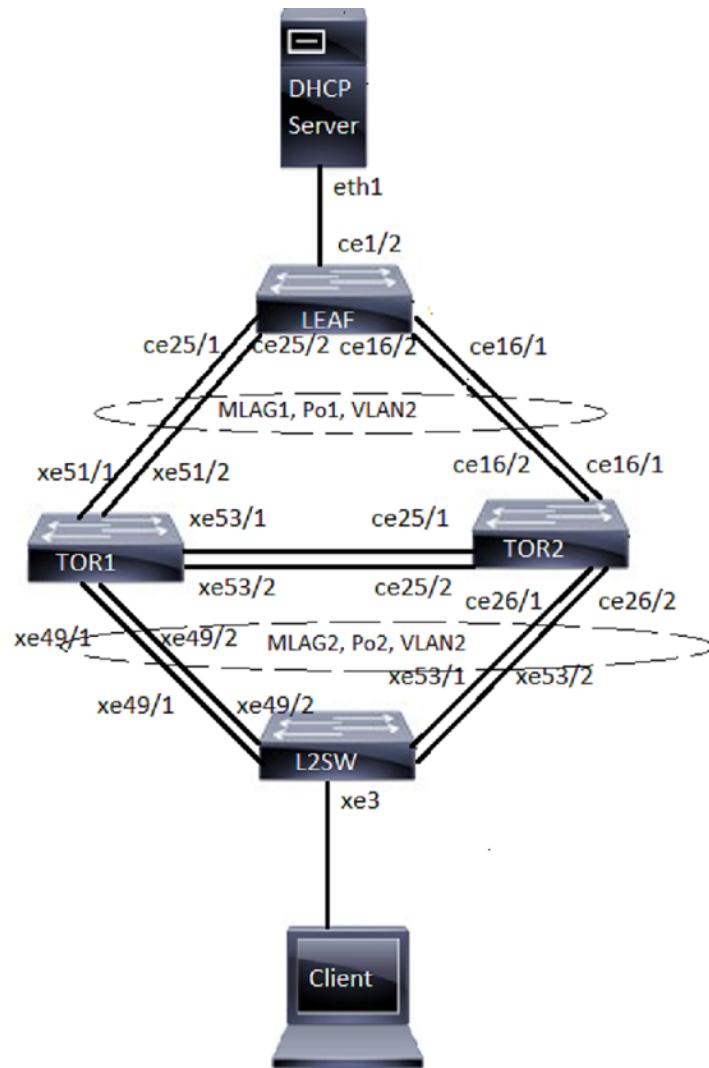

Configuring DHCP snooping over MLAG

LEAF:

```
#configure terminal
(config)#bridge 1 protocol rstp vlan-bridge
(config)#vlan 2 bridge 1 state enable
(config)#interface po1
```

Configure terminal.
Configuring the rstp vlan bridge
Configure VLAN for the bridge
Enter interface mode

¹Dynamic Host Configuration Protocol

```
(config-if)#switchport
(config-if)#bridge-group 1
(config-if)#switchport mode trunk
(config-if)#switchport trunk allowed vlan add 2
(config-if)#exit
(config)#interface ce1/2
(config-if)#switchport
(config-if)#bridge-group 1
(config-if)#switchport mode trunk
(config-if)#switchport trunk allowed vlan add 2
(config-if)#exit
(config)#interface ce16/1
(config-if)#channel-group 1 mode active
(config-if)#exit
(config)#interface ce16/2
(config-if)#channel-group 1 mode active
(config-if)#exit
(config)#interface ce25/1
(config-if)#channel-group 1 mode active
(config-if)#exit
(config)#interface ce25/2
(config-if)#channel-group 1 mode active
(config-if)#exit
```

Make the interface Layer 2
Associate the interface to bridge
Configure the mode as trunk
Allow vlan 2 on the interface
Exit interface mode
Enter interface mode
Make the interface Layer 2
Associate the interface to bridge
Configure the mode as trunk
Allow vlan 2 on the interface
Exit interface mode
Enter interface mode
Enable channel-group 1
Exit interface mode
Enter interface mode
Enable channel-group 1
Exit interface mode
Enter interface mode
Enable channel-group 1
Exit interface mode
Enter interface mode
Enable channel-group 1
Exit the configure mode

TOR1:

```
#configure terminal
(config)#bridge 1 protocol rstp vlan-bridge
(config)#vlan 2 bridge 1 state enable
(config)#ip dhcp snooping bridge 1
(config)#ip dhcp snooping vlan 2 bridge 1
(config)#interface mlag1
(config-if)#switchport
(config-if)#bridge-group 1
(config-if)#switchport mode trunk
(config-if)#switchport trunk allowed vlan add 2
(config-if)#ip dhcp snooping trust
(config-if)#exit
(config)#interface mlag2
(config-if)#switchport
(config-if)#bridge-group 1
(config-if)#switchport mode trunk
(config-if)# switchport trunk allowed vlan add 2
```

Configure terminal.
Configuring the rstp vlan bridge
Configure VLAN for the bridge
Enable DHCP Snooping on the bridge
Enable DHCP Snooping on the vlan 2
Enter Interface mode
Make the interface Layer 2
Associate the interface to bridge
Configure the mode as trunk
Allow vlan 2 on the interface
Enable the port as trusted.
Exit interface mode
Enter Interface mode
Make the interface Layer 2
Associate the interface to bridge
Configure the mode as trunk
Allow vlan 2 on the interface

(config-if)#exit	Exit interface mode
(config)#interface po1	Enter Interface mode
(config-if)#switchport	Make the interface Layer 2
(config-if)#mlag 1	Map po1 to mlag1
(config-if)#exit	Exit interface mode
(config)#interface po2	Enter Interface mode
(config-if)#switchport	Make the interface Layer 2
(config-if)#mlag 2	Map po2 to mlag2
(config-if)#exit	Exit interface mode
(config)#interface po5	Enter Interface mode
(config-if)#switchport	Make the interface Layer 2
(config-if)#bridge-group 1	Associate the interface to bridge
(config-if)#switchport mode trunk	Configure the mode as trunk
(config-if)#switchport trunk allowed add 2	Allow vlan 2 on the interface
(config-if)#exit	Exit interface mode
(config)#interface xe49/1	Enter Interface mode
(config-if)#channel-group 2 mode active	Enable channel-group 2
(config-if)#exit	Exit interface mode
(config)#interface xe49/2	Enter Interface mode
(config-if)#channel-group 2 mode active	Enable channel-group 2
(config-if)#exit	Exit interface mode
(config)#interface xe51/1	Enter Interface mode
(config-if)#channel-group 1 mode active	Enable channel-group 1
(config-if)#exit	Exit interface mode
(config)#interface xe51/2	Enter Interface mode
(config-if)#channel-group 1 mode active	Enable channel-group 1
(config-if)#exit	Exit interface mode
(config)#interface xe53/1	Enter Interface mode
(config-if)#channel-group 5 mode active	Enable channel-group 5
(config-if)#exit	Exit interface mode
(config)#interface xe53/2	Enter Interface mode
(config-if)#channel-group 5 mode active	Enable channel-group 5
(config-if)#exit	Exit interface mode
(config)#mcec domain configuration	Enter MCEC mode
(config-mcec-domain)#domain-address 1111.2222.3333	Domain address for the mlag domain
(config-mcec-domain)#domain-system-number 2	Configure the domain system number
(config-mcec-domain)#intra-domain-link po5	Specify the intra domain link for MLAG communication
(config-mcec-domain)#end	Exit the configure mode

TOR2:

#configure terminal	Configure terminal.
(config)#bridge 1 protocol rstp vlan-bridge	Configuring the rstp vlan bridge

```
(config)#vlan 2 bridge 1 state enable
(config)#ip dhcp snooping bridge 1
(config)#ip dhcp snooping vlan 2 bridge 1
(config)#interface mlag1
(config-if)#switchport
(config-if)#bridge-group 1
(config-if)#switchport mode trunk
(config-if)#switchport trunk allowed vlan add 2
(config-if)#ip dhcp snooping trust
(config-if)#exit
(config)#interface mlag2
(config-if)#switchport
(config-if)#bridge-group 1
(config-if)#switchport mode trunk
(config-if)#switchport trunk allowed vlan add 2
(config-if)#exit
(config)#interface po1
(config-if)#switchport
(config-if)#mlag 1
(config-if)#exit
(config)#interface po2
(config-if)#switchport
(config-if)#mlag 2
(config-if)#exit
(config)#interface po5
(config-if)#switchport
(config-if)#bridge-group 1
(config-if)#switchport mode trunk
(config-if)#switchport trunk allowed vlan add 2
(config-if)#exit
(config)#interface ce16/1
(config-if)#channel-group 1 mode active
(config-if)#exit
(config)#interface ce16/2
(config-if)#channel-group 1 mode active
(config-if)#exit
(config)#interface ce25/1
(config-if)#channel-group 5 mode active
(config-if)#exit
(config)#interface ce25/2
(config-if)#channel-group 5 mode active
(config-if)#exit
```

Configure VLAN for the bridge
Enable DHCP Snooping on the bridge
Enable DHCP Snooping on the vlan 2
Enter Interface mode
Make the interface Layer 2
Associate the interface to bridge
Configure the mode as trunk
Allow vlan 2 on the interface
Enable the port as trusted.
Exit interface mode
Enter Interface mode
Make the interface Layer 2
Associate the interface to bridge
Configure the mode as trunk
Allow vlan 2 on the interface
Exit interface mode
Enter Interface mode
Make the interface Layer 2
Map po1 to mlag1
Exit interface mode
Enter Interface mode
Make the interface Layer 2
Map po2 to mlag2
Exit interface mode
Enter Interface mode
Make the interface Layer 2
Associate the interface to bridge
Configure the mode as trunk
Allow vlan 2 on the interface
Exit interface mode
Enter Interface mode
Enable channel-group 1
Exit interface mode
Enter Interface mode
Enable channel-group 1
Exit interface mode
Enter Interface mode
Enable channel-group 5
Exit interface mode
Enter Interface mode
Enable channel-group 5
Exit interface mode

(config)#interface ce26/1	Enter Interface mode
(config-if)#channel-group 2 mode active	Enable channel-group 2
(config-if)#exit	Exit interface mode
(config)#interface ce26/2	Enter Interface mode
(config-if)#channel-group 2 mode active	Enable channel-group 2
(config-if)#exit	Exit interface mode
(config)#mcec domain configuration	Enter MCEC mode
(config-mcec-domain)#domain-address 1111.2222.3333	Domain address for the mlag domain
(config-mcec-domain)#domain-system-number 1	Configure the domain system number
(config-mcec-domain)#intra-domain-link po5	Specify the intra domain link for MLAG communication
(config-mcec-domain)#end	Exit the configure mode

L2SW:

#configure terminal	Configure terminal.
(config)#bridge 1 protocol rstp vlan-bridge	Configuring the rstp vlan bridge
(config)#vlan 2 bridge 1 state enable	Configure VLAN for the bridge
(config-if)#interface po2	Enter Interface mode
(config-if)#switchport	Make the interface Layer 2
(config-if)#bridge-group 1	Associate the interface to bridge
(config-if)#switchport mode trunk	Configure the mode as trunk
(config-if)#switchport trunk allowed vlan add 2	Allow vlan 2 on the interface
(config-if)#exit	Exit interface mode
(config)#interface xe3	Enter Interface mode
(config-if)#switchport	Make the interface Layer 2
(config-if)#bridge-group 1	Associate the interface to bridge
(config-if)#switchport mode trunk	Configure the mode as trunk
(config-if)#switchport trunk allowed vlan add 2	Allow vlan 2 on the interface
(config-if)#exit	Exit interface mode
(config)#interface xe49/1	Enter Interface mode
(config-if)#channel-group 2 mode active	Enable channel-group 2
(config-if)#exit	Exit interface mode
(config)#interface xe49/2	Enter Interface mode
(config-if)#channel-group 2 mode active	Enable channel-group 2
(config-if)#exit	Exit interface mode
(config)#interface xe53/1	Enter Interface mode
(config-if)#channel-group 2 mode active	Enable channel-group 2
(config-if)#exit	Exit interface mode
(config)#interface xe53/2	Enter Interface mode
(config-if)#channel-group 2 mode active	Enable channel-group 2
(config-if)#exit	Exit the configure mode

Static MLAG configuration for TOR1 and TOR2



Note: Only mlag related configs for static MLAG is provided. While rest of the configuration is similar to dynamic.

TOR1:

```
#configure terminal
(config)#interface mlag1
(config-if)#switchport
(config-if)#bridge-group 1
(config-if)#switchport mode trunk
(config-if)#switchport trunk allowed vlan add 2
(config-if)#mode active-standby
(config-if)#ip dhcp snooping trust
(config-if)#exit
(config)#interface mlag2
(config-if)#switchport
(config-if)#bridge-group 1
(config-if)#switchport mode trunk
(config-if)#switchport trunk allowed vlan add 2
(config-if)#mode active-active
(config-if)#exit
(config)#interface sa1
(config-if)#switchport
(config-if)#mlag 1
(config-if)#exit
(config)#interface sa2
(config-if)#switchport
(config-if)#mlag 2
(config-if)#exit
(config)#interface sa5
(config-if)#switchport
(config-if)#bridge-group 1
(config-if)#switchport mode trunk
(config-if)#switchport trunk allowed vlan add 2
(config-if)#exit
(config)#mcec domain configuration
(config-mcec-domain)#domain-address 1111.2222.3333
(config-mcec-domain)#domain-system-number 1
(config-mcec-domain)#intra-domain-link sa5
(config-mcec-domain)#end
```

Configure terminal.

Enter Interface mode

Make the interface Layer 2

Associate the interface to bridge

Configure the mode as trunk

Allow vlan 2 on the interface

Configure mlag mode for mlag1

Enable the port as trusted.

Exit interface mode

Enter Interface mode

Make the interface Layer 2

Associate the interface to bridge

Configure the mode as trunk

Allow vlan 2 on the interface

Configure mlag mode for mlag2

Exit interface mode

Enter Interface mode

Make the interface Layer 2

Map sa1 to mlag1

Exit interface mode

Enter Interface mode

Make the interface Layer 2

Map sa2 to mlag2

Exit interface mode

Enter Interface mode

Make the interface Layer 2

Associate the interface to bridge

Configure the mode as trunk

Allow vlan 2 on the interface

Exit interface mode

Enter MCEC mode

Domain address for the mlag domain

Configure the domain system number

Specify the intra domain link for MLAG communication

Exit the configure mode

TOR2:

```

#configure terminal
(config)#interface mlag1
(config-if)#switchport
(config-if)#bridge-group 1
(config-if)#switchport mode trunk
(config-if)#switchport trunk allowed vlan add 2
(config-if)#mode active-standby
(config-if)#ip dhcp snooping trust
(config-if)#exit
(config)#interface mlag2
(config-if)#switchport
(config-if)#bridge-group 1
(config-if)#switchport mode trunk
(config-if)#switchport trunk allowed vlan add 2
(config-if)#mode active-active
(config-if)#exit
(config)#interface sa1
(config-if)#switchport
(config-if)#mlag 1
(config-if)#exit
(config)#interface sa2
(config-if)#switchport
(config-if)#mlag 2
(config-if)#exit
(config)#interface sa5
(config-if)#switchport
(config-if)#bridge-group 1
(config-if)#switchport mode trunk
(config-if)#switchport trunk allowed vlan add 2
(config-if)#exit
(config)#mcec domain configuration
(config-mcec-domain)#domain-address 1111.2222.3333
(config-mcec-domain)#domain-system-number 2
(config-mcec-domain)#intra-domain-link sa5
(config-mcec-domain)#end

```

```

Configure terminal.
Enter Interface mode
Make the interface Layer 2
Associate the interface to bridge
Configure the mode as trunk
Allow vlan 2 on the interface
Configure mlag mode for mlag1
Enable the port as trusted.
Exit interface mode
Enter Interface mode
Make the interface Layer 2
Associate the interface to bridge
Configure the mode as trunk
Allow vlan 2 on the interface
Configure mlag mode for mlag2
Exit interface mode
Enter Interface mode
Make the interface Layer 2
Map sa1 to mlag1
Exit interface mode
Enter Interface mode
Make the interface Layer 2
Map sa2 to mlag2
Exit interface mode
Enter Interface mode
Make the interface Layer 2
Associate the interface to bridge
Configure the mode as trunk
Allow vlan 2 on the interface
Exit interface mode
Enter MCEC mode
Domain address for the mlag domain
Configure the domain system number
Specify the intra domain link for MLAG communication
Exit the configure mode

```

Validation**1. Verify Dhcps Sync PDUs:**

```

TOR1#show mcec statistics
Unknown MCCPDU received on the system      : 0

```

```

-----
IDP po5
-----
Valid RX Hello PDUs           : 2373
Valid TX Hello PDUs           : 2373
Valid RX Info PDUs            : 12
Valid TX Info PDUs            : 20
Valid RX Mac Sync PDUs        : 20
Valid TX Mac Sync PDUs        : 20
Valid RX Dhcps Sync PDUs      : 1
Valid TX Dhcps Sync PDUs      : 3
MLAG 1
Valid RX Info PDUs            : 6
Valid TX Info PDUs            : 10
MLAG 2
Valid RX Info PDUs            : 6
Valid TX Info PDUs            : 10
TOR1#
TOR2#show mcec statistics
Unknown MCCPDU received on the system : 0
-----
IDP po5
-----
Valid RX Hello PDUs           : 2384
Valid TX Hello PDUs           : 2385
Valid RX Info PDUs            : 18
Valid TX Info PDUs            : 12
Valid RX Mac Sync PDUs        : 20
Valid TX Mac Sync PDUs        : 16
Valid RX Dhcps Sync PDUs      : 3
Valid TX Dhcps Sync PDUs      : 1
MLAG 1
Valid RX Info PDUs            : 9
Valid TX Info PDUs            : 6
MLAG 2
Valid RX Info PDUs            : 9
Valid TX Info PDUs            : 6

```

2. Verify dhcp binding entires:

```

TOR2#
TOR1# show ip dhcp snooping binding bridge 1
Total number of static IPV4 entries : 0
Total number of dynamic IPV4 entries : 1
Total number of static IPV6 entries : 0
Total number of dynamic IPV6 entries : 0
MacAddress      IpAddress      Lease(sec)  Type           VLAN  Interfa
ce
-----
80a2.35e9.8323  20.20.20.2    315         dhcp-snooping  2     mlag2
TOR1#
TOR2#show ip dhcp snooping binding bridge 1
Total number of static IPV4 entries : 0
Total number of dynamic IPV4 entries : 1
Total number of static IPV6 entries : 0
Total number of dynamic IPV6 entries : 0
MacAddress      IpAddress      Lease(sec)  Type           VLAN  Interface
-----
80a2.35e9.8323  20.20.20.2    315         dhcp-snooping  2     mlag2

```

3. Verify that DHCP snooping is enabled on the bridge

```

TOR2#
TOR1#show ip dhcp snooping bridge 1
Bridge Group                : 1
DHCP snooping is           : Enabled
DHCP snooping option82 is  : Disabled
Verification of hwaddr field is : Disabled
Strict validation of DHCP packet is : Disabled
DB Write Interval(secs)    : 300
DHCP snooping is configured on following VLANs : 2
DHCP snooping is operational on following VLANs : 2
DHCP snooping trust is configured on the following Interfaces
Interface                    Trusted
-----
mlag1                        Yes
po5                          Yes
DHCP snooping IP Source Guard is configured on the following Interfaces
Interface                    Source Guard
-----
TOR1#
TOR2#show ip dhcp snooping bridge 1
Bridge Group                : 1
DHCP snooping is           : Enabled
DHCP snooping option82 is  : Disabled
Verification of hwaddr field is : Disabled
Strict validation of DHCP packet is : Disabled
DB Write Interval(secs)    : 300
DHCP snooping is configured on following VLANs : 2
DHCP snooping is operational on following VLANs : 2
DHCP snooping trust is configured on the following Interfaces
Interface                    Trusted
-----
mlag1                        Yes
po5                          Yes
DHCP snooping IP Source Guard is configured on the following Interfaces
Interface                    Source Guard
-----
TOR2#

```

4. Verify dhcp snooping running configs

```

TOR1#show running-config ip dhcp snooping
!
debug ip dhcp snooping all
!
ip dhcp snooping bridge 1
ip dhcp snooping vlan 2 bridge 1
interface mlag1
 ip dhcp snooping trust
!
interface po5
 ip dhcp snooping trust
!
TOR1#
TOR2#show running-config ip dhcp snooping
!
debug ip dhcp snooping all
!
ip dhcp snooping bridge 1
ip dhcp snooping vlan 2 bridge 1
interface mlag1
 ip dhcp snooping trust
!

```

```
interface po5
 ip dhcp snooping trust
 !
TOR2#
```

5. Verify mlag details:

```
TOR2#show mlag domain details
```

```
-----
Domain Configuration
-----
```

```
Domain System Number      : 1
Domain Address             : 1111.2222.3333
Domain Priority            : 32768
Intra Domain Interface    : po5
Hello RCV State           : Current
Hello Periodic Timer State : Slow Periodic
Domain Sync                : IN_SYNC
Neigh Domain Sync         : IN_SYNC
Domain Adjacency          : UP
-----
```

```
MLAG Configuration
-----
```

```
MLAG-1
```

```
Mapped Aggregator        : po1
Admin Key                 : 16385
Oper Key                  : 16385
Physical properties Digest : 54 a9 3a 2a 2b 50 65 bb 3c bc 3d bd c2 43 d6 22
Neigh Admin Key           : 32769
Neigh Physical Digest     : 54 a9 3a 2a 2b 50 65 bb 3c bc 3d bd c2 43 d6 22
Info RCV State            : Current
Info Periodic Time State  : Standby
Total Bandwidth           : 40g
Mlag Sync                 : IN_SYNC
Mlag Mode                 : Active-Active
Mlag State                : UP
```

```
MLAG-2
```

```
Mapped Aggregator        : po2
Admin Key                 : 16386
Oper Key                  : 16386
Physical properties Digest : 54 a9 3a 2a 2b 50 65 bb 3c bc 3d bd c2 43 d6 22
Neigh Admin Key           : 32770
Neigh Physical Digest     : 54 a9 3a 2a 2b 50 65 bb 3c bc 3d bd c2 43 d6 22
Info RCV State            : Current
Info Periodic Time State  : Standby
Total Bandwidth           : 40g
Mlag Sync                 : IN_SYNC
Mlag Mode                 : Active-Active
Mlag State                : UP
```

```
TOR2#
```

```
TOR1#show mlag domain details
```

```
-----
Domain Configuration
-----
```

```
Domain System Number      : 2
Domain Address             : 1111.2222.3333
Domain Priority            : 32768
Intra Domain Interface    : po5
Hello RCV State           : Current
Hello Periodic Timer State : Slow Periodic
Domain Sync                : IN_SYNC
Neigh Domain Sync         : IN_SYNC
Domain Adjacency          : UP
-----
```

```
MLAG Configuration
-----
```

```
MLAG-1
Mapped Aggregator      : po1
Admin Key              : 32769
Oper Key               : 16385
Physical properties Digest : 54 a9 3a 2a 2b 50 65 bb 3c bc 3d bd c2 43 d6 22
Neigh Admin Key       : 16385
Neigh Physical Digest  : 54 a9 3a 2a 2b 50 65 bb 3c bc 3d bd c2 43 d6 22
Info RCV State        : Current
Info Periodic Time State : Standby
Total Bandwidth       : 40g
Mlag Sync             : IN_SYNC
Mlag Mode             : Active-Active
Mlag State            : UP
MLAG-2
Mapped Aggregator      : po2
Admin Key              : 32770
Oper Key               : 16386
Physical properties Digest : 54 a9 3a 2a 2b 50 65 bb 3c bc 3d bd c2 43 d6 22
Neigh Admin Key       : 16386
Neigh Physical Digest  : 54 a9 3a 2a 2b 50 65 bb 3c bc 3d bd c2 43 d6 22
Info RCV State        : Current
Info Periodic Time State : Standby
Total Bandwidth       : 40g
Mlag Sync             : IN_SYNC
Mlag Mode             : Active-Active
Mlag State            : UP
TOR1#
```

No IP Unreachable

Overview

The "no ip unreachable" feature in networking devices is a configuration used to enhance network security and efficiency by disabling the generation of Internet Control Message Protocol (ICMP¹) unreachable messages. Normally, these messages are sent by routers and other network devices in response to packets that cannot be delivered to their intended destination for various reasons.

When the "no ip unreachable" command is enabled, the network device stops sending these ICMP unreachable messages.

Supported ICMP Unreachable Codes

Here are the codes used in ICMPv6 Unreachable.

Table 75. ICMP Unreachable Codes

Code	Message	Description
0	Destination network unreachable	
1	Destination host unreachable	
2	Destination protocol unreachable	
3	Destination port unreachable	The destination network is not reachable from the current router.
4	Fragmentation needed and DF flag set	The specific destination host within a reachable network is not accessible.
5	Source Route Failed	The protocol specified in the packet is not supported by the destination.
6	Destination Network Unknown	The destination port is not open or not listening on the destination device.
7	Destination Host Unknown	NA
8	Source Host Isolated	NA
9	Network Administratively Prohibited	NA
10	Network Administratively Prohibited	NA
11	Network Unreachable for TOS	NA
12	Host Unreachable for TOS	NA
13	Communication Administratively Prohibited	NA
14	Host Precedence Violation	NA

¹Internet Control Message Protocol (ICMP) is a fundamental protocol used in networking to relay error messages and operational information.

Table 75. ICMP Unreachable Codes (continued)

Code	Message	Description
15	Precedence Cutoff in Effect	NA

Supported ICMPv6 Unreachable Codes

Here are the codes used in ICMPv6 Unreachable.

Table 76. ICMPv6 Unreachable Codes

Codes	Description
0	No route to destination
1	Communication with destination administratively prohibited
2	Beyond scope of source address
3	Address unreachable
4	Port unreachable
5	Source address failed ingress/egress policy
6	Reject route to destination

Feature Characteristics

The "no ip unreachable" feature is used to prevent a device from sending ICMP unreachable messages. These messages are typically generated when a router cannot forward a packet because the destination is unreachable. Disabling these messages can enhance network performance and security.

Benefits

The advantages of utilizing a No IP Unreachables:

- Enhanced Security
- Performance Optimization
- Simplified Troubleshooting.

Configuration

To configure "no ip unreachable," enter interface configuration mode on the device, select the outgoing interface, and apply the "no ip unreachable" command. This prevents the device from sending **ICMP**¹ unreachable messages for packets sent through that interface, thereby enhancing network security.

¹Internet Control Message Protocol (ICMP) is a fundamental protocol used in networking to relay error messages and operational information.

Example for Suppressing the ICMP Destination Host Unreachable Message

With the configuration shown in the diagram, R2 is set to drop ICMP unreachable messages for packets exiting from interface ge10. The following steps describe how it operates. The procedures in this section use the topology in [Figure 72](#)

Figure 72. No IP Unreachable

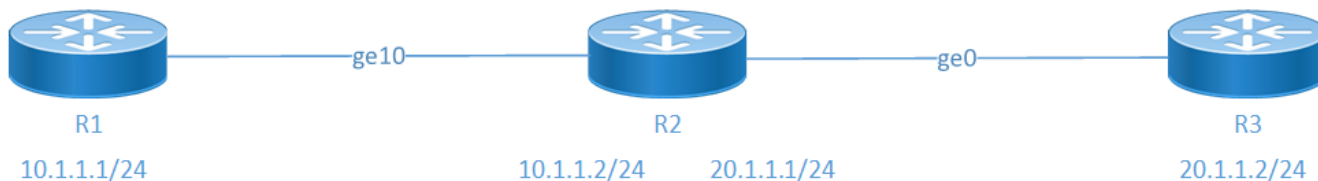

1. Packet Reception: R2 receives a packet that it needs to forward to a destination.
2. Routing Decision: R2 checks its routing table to determine the next hop for the packet.
3. Unreachable Destination: If there is no valid route to reach the destination 20.1.1.3, R2 would normally generate an ICMP unreachable message, indicating Destination Host Unreachable.
4. Suppression of ICMP Message: With the "no ip unreachable" command enabled on R2's interface ge10, R2 suppresses outgoing ICMP messages from interface ge10, effectively dropping the packet without notifying the sender. In this case, R2 drops the Destination Host Unreachable message.

Example for Suppressing the ICMP Destination Network Unreachable Message

With the configuration shown in the diagram, R2 is set to drop ICMP unreachable messages for packets going out from interface ge10. The following steps describe how it operates. The procedures in this section use the topology in

1. Packet Reception: R2 receives a packet that it needs to forward to a destination.
2. Routing Decision: R2 checks its routing table to determine the next hop for the packet.
3. Unreachable Destination: If there is no valid route to reach the destination network 30.1.1.1, R2 would normally generate an ICMP unreachable message, indicating Destination Network Unreachable.
4. Suppression of ICMP Message: With the "no ip unreachable" command enabled on R2's interface ge10, R2 suppresses outgoing ICMP messages from interface ge10, effectively dropping the packet without notifying the sender. In this case, R2 drops the "Destination Network Unreachable" message.

Example for Suppressing the ICMP Fragmentation Needed Message

With the configuration shown in the diagram, R2 is set to drop ICMP unreachable messages for packets going out from interface ge10. The following steps describe how it operates. The procedures in this section use the topology in [Figure 73. No IPv6 Unreachable \(page 1202\)](#)

1. Packet Reception: R2 receives a packet that it needs to forward to a destination.
2. Routing Decision: R2 checks the data size of the packet to transmit to the next hop. In this case, the data size is 1328 bytes.
3. Unreachable Destination: Since the maximum transmission unit (MTU) on R2 is set to 1200 bytes, R2 would normally generate an ICMP unreachable message, indicating "Fragmentation needed but DF is set."

4. Suppression of ICMP Message: With the "no ip unreachable" command enabled on R2's interface ge10, R2 suppresses outgoing ICMP messages from interface ge10, effectively dropping the packet without notifying the sender. In this case, R2 drops the "Fragmentation needed" message.

Topology

The procedures in this section use the topology in [Figure 73](#)

Figure 73. No IPv6 Unreachable

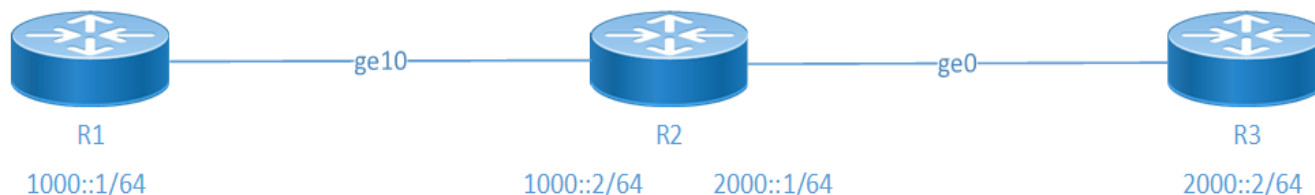

Configurations

This configuration suppresses ICMP messages from being sent out of the interface. Perform the following steps to configure no ip unreachable functionality for R2.

No IP Unreachable Configuration

- Supports all type of nodes.

Configuring No IP/IPv6 Unreachable

1. To enter into interface mode, execute the following command in the config mode. Access interface configuration mode for the interface.

```
R2(config)#interface ge10
```

Assign an IPv6 address to the interface using the ipv6 address command followed by the desired IPv6 address and subnet mask.

(ipv6 address 1000::1/64)

2. To enable No IP/IPv6 Unreachable, execute the following command.

```
R2(config-if)#no ip unreachable
R2(config-if)#no ipv6 unreachable
```

3. To configure, execute the following command.

```
R2(config-if)#commit
```

4. Verify the configuration as instructed in the validation.

Snippet configuration on R1 router is as follows:

```
!
interface ge10
 ip address 10.1.1.1/24
!
```

Snippet configuration on R2 router is as follows:

```
!  
interface ge10  
  ip address 10.1.1.2/24  
  no ip unreachable  
!
```

Validation

To verify that the no ip unreachable command has been applied to the interface, you can use the following command:

R1:

```
OcNOS#ping 20.1.1.3  
Press CTRL+C to exit  
PING 20.1.1.3 (20.1.1.3) 100(128) bytes of data.  
From 10.1.1.2 icmp_seq=1 Destination Host Unreachable  
From 10.1.1.2 icmp_seq=2 Destination Host Unreachable  
From 10.1.1.2 icmp_seq=3 Destination Host Unreachable  
From 10.1.1.2 icmp_seq=4 Destination Host Unreachable  
From 10.1.1.2 icmp_seq=5 Destination Host Unreachable  
From 10.1.1.2 icmp_seq=6 Destination Host Unreachable  
  
--- 20.1.1.3 ping statistics ---  
7 packets transmitted, 0 received, +6 errors, 100% packet loss, time 142ms  
pipe 3  
OcNOS#
```

No IP Unreachable Unconfiguration

To revert the suppression of ICMP¹ messages to the original configuration, follow the steps.

1. Enter the global configuration mode.

```
R2#configure terminal
```

2. Configure the interface ge10.

```
R2(config)#interface ge10
```

3. Re-enable ICMP unreachable messages.

```
R2(config-if)#ip unreachable
```

4. To commit the changes exit.

```
R2(config)#commit  
R2(config)#exit
```

Validation**R1:**

```
OcNOS#ping 20.1.1.3  
Press CTRL+C to exit  
PING 20.1.1.3 (20.1.1.3) 100(128) bytes of data.
```

¹Internet Control Message Protocol (ICMP) is a fundamental protocol used in networking to relay error messages and operational information.

```

--- 20.1.1.3 ping statistics ---
 8 packets transmitted, 0 received, 100% packet loss, time 167ms
OcNOS#

```

No IPv6 Unreachable Unconfiguration

To revert the suppression of ICMPv6 messages to the original configuration, follow the steps.

1. Enter the global configuration mode.

```
R2#configure terminal
```

2. Configure the interface ge10.

```
R2(config)#interface ge10
```

3. Re-enable **ICMP**¹ unreachable messages.

```
R2(config-if)#ipv6 unreachable
```

4. To commit the changes exit.

```
R2(config)#commit
R2(config)#exit
```

CLI Commands

The no ip unreachable introduces the following configuration commands:

no ip unreachable	1204
no ipv6 unreachable	1205

no ip unreachable

This command to suppress the **ICMP**² messages going out from the interface.

Remove the no form of this command to allow ICMP messages going out from the interface.

Command Syntax

```

no ip unreachable
ip unreachable

```

Parameters

None

Default

None

Command Mode

Interface mode

¹Internet Control Message Protocol (ICMP) is a fundamental protocol used in networking to relay error messages and operational information.

²Internet Control Message Protocol (ICMP) is a fundamental protocol used in networking to relay error messages and operational information.

Applicability

This command was introduced in OcNOS version 6.5.2.

Examples

```
#configure terminal
(config)# interface ge0
(config-if)#no ip unreachable
```

no ipv6 unreachable

This command to suppress the ICMPv6 messages going out from the interface.

Remove the no form of this command to allow ICMPv6 messages going out from the interface.

Command Syntax

```
no ipv6 unreachable
ipv6 unreachable
```

Parameters

None

Default

None

Command Mode

Interface mode

Applicability

This command was introduced in OcNOS version 6.5.2.

Examples

```
#configure terminal
(config)# interface ge0
(config-if)#no ipv6 unreachable
```

Port Breakout Configuration

VLAN Port Breakout Configuration	1207
Port Breakout (100G and 400G) on Tomahawk and Trident Series Platforms	1215
Overview	1215

VLAN Port Breakout Configuration

Overview

The Port Breakout system enables the segmentation of 40GbE and 100GbE ports into multiple smaller capacity ports, providing greater flexibility in network configurations. This allows 40G ports to be split into 4x10GbE and 100G ports into 4x10GbE, 4x25GbE, or 2x50GbE configurations. The feature is essential for modern virtualized data center networks that require various interface speeds while maintaining cost-effective cabling and seamless scalability.

A Port Breakout group consists of four ports: one control port and three subsidiary ports. The control port manages the breakout, while the subsidiary ports function based on the breakout configuration.

Example:

- xe50/1 (Control Port)
- xe50/2, xe50/3, xe50/4 (Subsidiary Ports)

The first numeral (for example: 50) represents the slot of the port on a board, while the numerals after "/" denote the port numbers on that slot. The control port can function as a 40G or 100G port, and its associated subsidiary ports inherit the breakout configuration. For Transceiver types mentioned in `fec` command is enabled by default for both control port and the rest 3 subsidiary ports. If Peer is not supporting **FEC**¹, `fec off` needs to be configured on the ports manually.

Supported Breakout Configurations:

- 40G Ports
- 40G to 4x10G breakout ports
- 100G Ports
- 100G to 4x10G breakout ports
- 100G to 4x25G breakout ports (Autonegotiation not supported due to hardware limitations)
- 100G to 2x50G breakout ports (Autonegotiation not supported due to hardware limitations)

Configuration Restrictions for Subsidiary Ports

- Port breakout enable/disable is not allowed on subsidiary ports.
- Speed and duplex configurations are not allowed on inactive subsidiary ports.
- In a 100G to 2x50G breakout, only one control and one subsidiary port are active. Example: Port XE1/1 (Control) and Port XE1/3 (Active Subsidiary).
 - Example: Port XE1/1 (Control) and Port XE1/3 (Active Subsidiary)

Terminology

Following is a description of terms and concepts used to describe port breakout.

- Control Port (Ctl): A split-able 40G or 100G port.
- Port Breakout (Brk): A control port split into multiple smaller capacity ports.

¹FEC is a technique that detects and corrects errors during data transmission to maintain the reliability of the communication system.

- **Subsidiary Ports:** Ports associated with a control port, which can be active or inactive.
- **Inactive Ports (IA):** Subsidiary ports whose control port is not configured for Port Breakout.

Prerequisite

From OcNOS version 5.1 onwards, VLAN reservation is required before configuring Port Breakout. This prevents reserved VLANs from being used in bridge configurations.



Note: Once VLANs are reserved, those vlans cannot be used for bridge configuration.

The advantage of using vlan-reservation is when port breakout is not required,

- then released VLANs can be used for bridge configuration up to maximum of 4062.
- to use the user defined vlan-range values for bridge configuration, do the following:
 - Completely delete the user-defined vlan-ranges values as deleting subset of it is not allowed.
 - Remove all the port breakout CLIs configured
 - Unconfigure the complete set of user defined vlans using no port breakout enable and no vlan-reservation vlan-id/vlan-range.
 - Reconfigure bridge vlans, vlan-reservation and port breakout.
- Use the show vlan-reservation command to view the VLANs that the system automatically allocates. Allocate VLANs correctly for breakout ports and manually reserve a sufficient number of VLANs based on the expected breakout port count.
- Execute the following command to identify the available breakout ports on the system:

```
show port-breakout details
```
- Ensure to reserve a continuous range of VLANs for breakout ports to maintain consistency and prevent VLAN fragmentation.

Configure VLAN Reservation

1. Enter VLAN database mode to modify VLAN configurations:

```
#configure terminal
(config)# vlan database
```

2. Reserve VLAN IDs or a VLAN range to ensure that these VLANs are dedicated for port breakout configuration and are not used for bridge configurations.

```
(config-if)# vlan-reservation 4050-4058
```

3. Exit VLAN database mode to save changes:

```
(config-if)#exit
```

Validation

VLAN-reservation validation

```
#show vlan-reservation
VLAN ID Status
=====
4050 free
4051 free
4052 free
```

```
4053 free
4054 free
4055 free
4056 free
4057 free
4058 free
```

Configure Port Breakout

To configure port breakout, follow these steps:

1. Enter configuration mode:

```
#configure terminal
```

2. Select the desired interface:

```
(config)#interface ce1/1
```

3. Enable the required port breakout 4x10G:

```
(config-if)# port breakout enable 4x10G
```



Note: Similarly, you can configure any breakout option as per network requirements. For example: 4x25g, 2x50g.

4. Exit interface mode:

```
(config-if)#exit
```

Validation

```
#show interface brief
```

```
Codes: ETH - Ethernet, LB - Loopback, AGG - Aggregate, MLAG - MLAG Aggregate
FR - Frame Relay, TUN -Tunnel, PBB - PBB Logical Port, VP - Virtual Port
CVP - Channelised Virtual Port, METH - Management Ethernet, UNK- Unknown
ED - ErrDisabled, PD - Protocol Down, AD - Admin Down, IA - InActive
PD(Min-links) - Protocol Down Min-links
DV - DDM Violation, NA - Not Applicable
NOM - No operational members, PVID - Port Vlan-id
Ctl - Control Port (Br-Breakout/Bu-Bundle)
```

```
-----
Ethernet Type PVID Mode Status Reason Speed Port Ctl Br/Bu
Interface Ch #
-----
```

```
ce1/1 ETH -- routed up none 10g -- Br Yes
ce1/2 ETH -- routed down IA -- -- No No
ce1/3 ETH -- routed up none 10g -- No No
ce1/4 ETH -- routed down IA -- -- No No
```

Configure Port Breakout at Global Configuration Level

perform the following steps to configure port breakout at the global configuration level for Trident III and Tomahawk II platforms:

1. Enter configuration mode:

```
#configure terminal
```

2. Specify the port number and breakout mode:

```
(config)# port 49 breakout 4X10g
```



Note: You can replace 4X10g with other breakout(2X50g or 4X10g 4X25g) options as needed.

3. Exit configuration mode:

```
(config)#exit
```



Note: After the port breakout, the interface name is changed to xe49/1-xe49/4 globally.

Validation

```
VLAN-reservation validation
#show vlan-reservation
VLAN ID Status
=====
4050 allocated
4051 allocated
4052 allocated
4053 free
4054 free
4055 free
4056 free
4057 free
4058 free

#show running-config interface xe49/1
!
interface xe49/1
!

#show port-breakout details
-----
Max Brkout Avail Max Brkout Avail

0 x4X or 0 x2X

4 x4X or 4 x2X

-----
Block1 Block2
-----
Port || Mode Port || Mode
-----
1 40
2 41
3 43
4 44
```

```
5 45
6 46
7 47
8 48
9 49 4X10G
10 50 4X10G
11 51 4X10G
12 52 4X10G
13 53
14 54
15 55
16 56
17
```

Unconfigure VLAN Reservation

Perform the following steps to unconfigure the VLAN reservation when it is no longer needed:

1. Enter configuration mode:

```
#configure terminal
```

2. Access the VLAN database:

```
(config)# vlan database
```

3. Remove the VLAN reservation:

```
(config-if)# no vlan-reservation 4050-4058
```

4. Exit configuration mode:

```
(config-if)#exit
```

Validation

Below output before applying port-breakout config on xe50/1:

Unconfigure Port Breakout

Perform the following steps to disable the port breakout configuration from an interface:

1. Enter configuration mode:

```
#configure terminal
```

2. Select the interface where port breakout is configured:

```
(config)#interface xe50/1
```

3. Disable the port breakout:

```
(config-if)#no port breakout
```

4. Exit interface mode:

```
(config-if)#exit
```

Validation

```
#show interface brief
Codes: ETH - Ethernet, LB - Loopback, AGG - Aggregate, MLAG - MLAG Aggregate
FR - Frame Relay, TUN -Tunnel, PBB - PBB Logical Port, VP - Virtual Port
CVP - Channelised Virtual Port, METH - Management Ethernet, UNK- Unknown
ED - ErrDisabled, PD - Protocol Down, AD - Admin Down, IA - InActive
PD(Min-links) - Protocol Down Min-links
DV - DDM Violation, NA - Not Applicable
NOM - No operational members, PVID - Port Vlan-id
Ctl - Control Port (Br-Breakout/Bu-Bundle)
```

```

-----
Interface Type Status Reason Speed
Interface
-----
eth0 METH up -- 1g

-----
Interface Status Description
-----
lo up --
lo.management up --

-----
Ethernet Type PVID Mode Status Reason Speed Port Ctl Br/Bu
Interface Ch #
-----
xe47 ETH -- routed down PD 10g -- No No
xe48 ETH -- routed down PD 10g -- No No
xe49/1 ETH -- routed down PD 40g -- Br No
xe49/2 ETH -- routed down IA -- -- No No
xe49/3 ETH -- routed down IA -- -- No No
xe49/4 ETH -- routed down IA -- -- No No
xe50/1 ETH -- routed up none 40g -- Br No
xe50/2 ETH -- routed down IA -- -- No No
xe50/3 ETH -- routed down IA -- -- No No
xe50/4 ETH -- routed down IA -- -- No
#show interface xe50/1
Interface xe50/1
Flexport: Breakout Control Port (Active): Break Out disabled
Hardware is ETH Current HW addr: a82b.b5ad.db6f
Physical:a82b.b5ad.dba4 Logical:(not set)
Port Mode is Router
Interface index: 10053
Metric 1 mtu 1500 duplex-full link-speed 40g
<UP,BROADCAST,RUNNING,MULTICAST>
VRF1 Binding: Not bound
DHCP client2 is disabled.
Last Flapped: 2001 Feb 13 18:42:15 (00:03:20 ago)
Statistics last cleared: Never
inet6 fe80::aa2b:b5ff:fead:db6f/64
5 minute input rate 20 bits/sec, 0 packets/sec
5 minute output rate 20 bits/sec, 0 packets/sec
RX
unicast packets 0 multicast packets 7 broadcast packets 0
input packets 7 bytes 766
jumbo packets 0
runts 0 giants 0 CRC 0 fragments 0 jabbers 0
input error 0
input with dribble 0 input discard 0
Rx pause 0
TX
unicast packets 0 multicast packets 7 broadcast packets 0
output packets 7 bytes 766
jumbo packets 0

```

¹Virtual Routing and Forwarding

²A DHCP client is a hardware device or software that uses DHCP to get the network configuration information from a DHCP Server. VRF: VRF creates a logically isolated routing table within a single physical network device. Each VRF instance works as an independent routing instance that enables separate network traffic, maintains different routing tables, and provides network isolation.

```
output errors 0 collision 0 deferred 0 late collision 0
output discard 0
Tx pause 0
#show interface xe50/2
Interface xe50/2
Flexport: Non Control Port (InActive)
Hardware is ETH Current HW addr: a82b.b5ad.db6f
Physical:a82b.b5ad.dba5 Logical:(not set)
Port Mode is Router
Interface index: 10054
Metric 1 mtu 1500
<UP,BROADCAST,MULTICAST>
VRF Binding: Not bound
DHCP1 client is disabled.
Last Flapped: 2001 Feb 13 18:42:15 (00:03:46 ago)
Statistics last cleared: Never
inet6 fe80::aa2b:b5ff:fead:db6f/64
5 minute input rate 0 bits/sec, 0 packets/sec
5 minute output rate 0 bits/sec, 0 packets/sec
RX
unicast packets 0 multicast packets 0 broadcast packets 0
input packets 0 bytes 0
jumbo packets 0
runts 0 giants 0 CRC 0 fragments 0 jabbers 0
input error 0
input with dribble 0 input discard 0
Rx pause 0
TX
unicast packets 0 multicast packets 0 broadcast packets 0
output packets 0 bytes 0
jumbo packets 0
output errors 0 collision 0 deferred 0 late collision 0
output discard 0
Tx pause 0
#show interface xe50/3
Interface xe50/3
Flexport: Non Control Port (InActive)
Hardware is ETH Current HW addr: a82b.b5ad.db6f
Physical:a82b.b5ad.dba6 Logical:(not set)
Port Mode is Router
Interface index: 10055
Metric 1 mtu 1500
<UP,BROADCAST,MULTICAST>
VRF Binding: Not bound
DHCP client is disabled.
Last Flapped: 2001 Feb 13 18:42:15 (00:07:30 ago)
Statistics last cleared: Never
inet6 fe80::aa2b:b5ff:fead:db6f/64
5 minute input rate 0 bits/sec, 0 packets/sec
5 minute output rate 0 bits/sec, 0 packets/sec
RX
unicast packets 0 multicast packets 0 broadcast packets 0
input packets 0 bytes 0
jumbo packets 0
runts 0 giants 0 CRC 0 fragments 0 jabbers 0
input error 0
input with dribble 0 input discard 0
Rx pause 0
TX
unicast packets 0 multicast packets 0 broadcast packets 0
output packets 0 bytes 0
```

¹Dynamic Host Configuration Protocol

```
jumbo packets 0
output errors 0 collision 0 deferred 0 late collision 0
output discard 0
Tx pause 0

#show interface xe50/4
Interface xe50/4
Flexport: Non Control Port (InActive)
Hardware is ETH Current HW addr: a82b.b5ad.db6f
Physical:a82b.b5ad.dba7 Logical:(not set)
Port Mode is Router
Interface index: 10056
Metric 1 mtu 1500
<UP,BROADCAST,MULTICAST>
VRF Binding: Not bound
DHCP client is disabled.
Last Flapped: 2001 Feb 13 18:42:15 (00:07:36 ago)
Statistics last cleared: Never
inet6 fe80::aa2b:b5ff:fead:db6f/64
5 minute input rate 0 bits/sec, 0 packets/sec
5 minute output rate 0 bits/sec, 0 packets/sec
RX
unicast packets 0 multicast packets 0 broadcast packets 0
input packets 0 bytes 0
jumbo packets 0
runts 0 giants 0 CRC 0 fragments 0 jabbers 0
input error 0
input with dribble 0 input discard 0
Rx pause 0
TX
unicast packets 0 multicast packets 0 broadcast packets 0
output packets 0 bytes 0
jumbo packets 0
output errors 0 collision 0 deferred 0 late collision 0
output discard 0
Tx pause 0
```

Here xe50/1 is a control Port whereas xe50/2, xe50/3 and xe50/4 are their subsidiary ports. The out-put shows only xe50/1 is active (interface up and running) whereas other ports are inactive (interface up but not running).

Port Breakout (100G and 400G) on Tomahawk and Trident Series Platforms

Overview

Port breakout divides high-speed Ethernet ports into multiple lower-speed ports, ensuring efficient network connectivity and seamless scalability. Modern networks require various Ethernet interface speeds, including 10GbE, 25GbE, 40GbE, 50GbE, 100GbE, and 400GbE. To meet evolving speed and density demands, networks rely on cost-effective cabling solutions that support flexible connectivity.



Note: The port breakout functionality is supported only for QSFP28 100G ports explicitly designated for breakout configurations. Ports such as 10GbE SFP+ and 25GbE SFP28 do not support this functionality.

400G Port Breakout

Each 400GbE port (**QSFP-DD¹**) supports up to eight serdes, with each serdes delivering 50G of bandwidth. This capability enables multiple breakout configurations, including:

- 8x50G
- 4x100G
- 2x200G
- 8X50g
- 8X25g
- 8X10g

Port breakout allows networks to allocate bandwidth efficiently and optimize connectivity while maintaining full Layer 2 (L2) and Layer 3 (L3) support. The default SERDES mode operates at 50G.

100G Port Breakout

100GbE ports break out into multiple lower-speed interfaces through a secure and reliable breakout cabling solution. Supported configurations include:

- 4x1G
- 4x10G
- 4x25G
- 2x50G

Control ports manage breakout functionality, while the newly created lower-speed ports function as subsidiary ports. When breaking out a 100GbE port (for example: ce3) into four 10GbE ports, the system removes the original port (ce3) and creates four new ports (ce3/1, ce3/2, ce3/3, and ce3/4). These breakout ports support all standard L2 and L3 features, just like regular ports.

¹QSFP-DD stands for Quad Small Form Factor Pluggable Double Density. QSFP-DD modules provide a scalable, high-bandwidth solution for data center networking, enabling efficient data transmission and network performance in modern computing environments.

When removing the breakout configuration, the system deletes the subsidiary ports and restores the original 100GbE port.

Port breakout maximizes hardware efficiency, adapts to changing bandwidth demands, and enables a seamless transition between different Ethernet speeds.

Feature Characteristics

- **Port Speed Adaptability:** Breakout configurations enable connection to devices with different port speeds, enhancing network flexibility and bandwidth optimization.
- **Enhanced Port Utilization:** Improves available faceplate capacity and facilitates easier upgrades to higher-speed networks.

Benefits

Utilizing a 100G and 400G port breakout offers several advantages:

- **Increased Port Density:** Maximizes equipment utilization and conserves rack space.
- **Energy Efficiency:** Reduces power consumption per port.
- **Future-Ready Networks:** Simplifies transitions to higher-speed interfaces, ensuring scalability.

Platform-Specific Details 100G Port

Platform Name	100G Port Details	Interface Level Breakout	Global Level Breakout Configurations Irrelevant of the HW Profile
S9110-32X	32 x 100 QSFP28 interfaces	NA	Yes
S8901-54XC	6 x 100G QSFP28 with QSFP28 interfaces	NA	Yes
AS5835-54X	2 x 100GE with QSFP28 interfaces	NA	Yes
AS7326-56X	8 x 100GE with QSFP28 interfaces	NA	Yes
AS7726-32X	32 x 100GE with QSFP28 interfaces	NA	NA
AS7816-64X	64 x 100GE with QSFP28 interfaces QSFP28	NA	Yes
AS9736-64D	16X400G QSFP56-DD(24W) 48X400G QSFP56-DD(13W)	NA	Yes
AS7712-32X	32 x 100GE each splittable into 4 x 10GE or 2 x 50GE or 4 x 25GE	Yes	NA

Platform-Specific Details 400G Port

Platform Name	100G/400G Port Details	Interface Level Breakout	Global Level Breakout Configurations Irrelevant of the HW Profile
AS9716-32D	32 x 400G GE with QSFP28 interfaces	NA	Yes
AS9726-32DB	432X400G QSFP56-DD	NA	Yes

Key Considerations

- Port breakout is supported on all 100G interfaces except those with an external PHY. Use the `show hsl extphy status` command to identify these ports.
- Switching directly between breakout modes (4x10G and 4x25G) is not possible. To change the mode, first remove the existing breakout configuration.
- Port breakout is not supported on ports with sub-interfaces or active services. Before enabling breakout, all services on the interface must be unconfigured. After breakout, services can be reconfigured on the breakout ports.
- If the error message `% Max egress credit limit reached` appears during port breakout configuration, reducing the speed of some interfaces may be required due to hardware limitations.

Configuration

The Qumran platform supports global level and interface-level breakout for both Trident3 (TR3) platformsTomahawk (TH) platforms.

Topology

The topology depicts a 100G QSFP28 port on Router 1 (R1) split into four 25G sub-ports (CE3/1 to CE3/4), each connecting to downstream routers (R2 to R5) via XE1 interfaces. This configuration enhances port density and enables efficient utilization of high-speed ports.

Figure 74. Qumran 2 100G Port Breakout

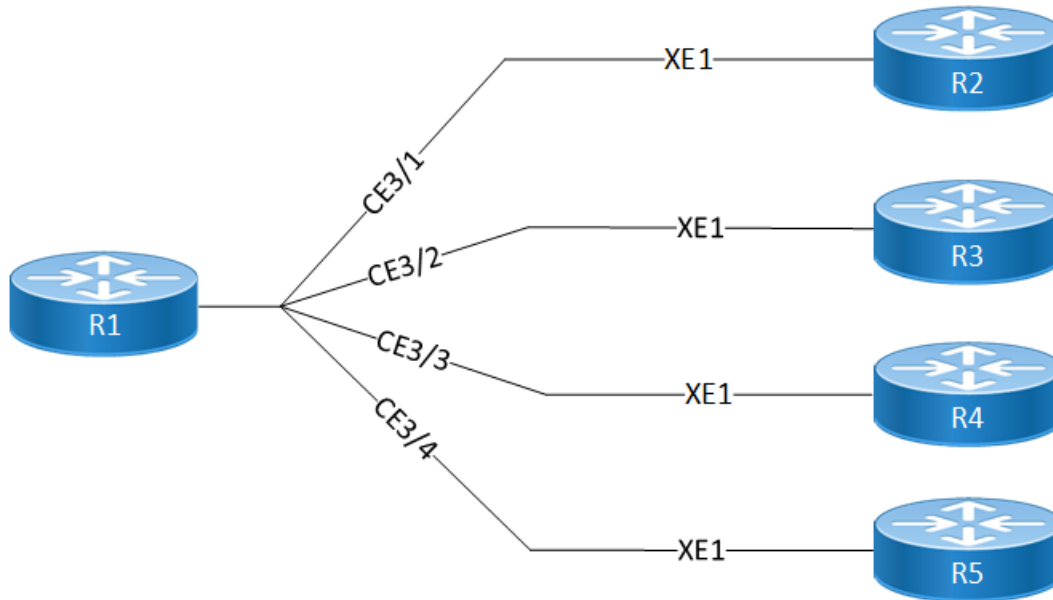

Configuration for Global-Level Breakout (No Reload Required)

This method configures the port breakout without requiring a system reload. Perform the following to configure port breakout on a supported device:

1. Enter the configuration mode:

```
ocnos#configure terminal
```

2. For the interface (**ce20**), set the breakout type (for example: 1X40g, 4x25G, 2X50g, 4X10g, and 4X25g) depending on the network requirements:

```
ocnos(config)#port ce20 breakout 4X25g
```

3. Save the configuration view the changes:

```
ocnos(config)#commit
```

Validation

To verify the port breakout configuration, execute the following command:

```
OcNOS#show interface brief | inc xe20
xe20/1      ETH      --      routed      down      PD      25g      --      No      No
xe20/2      ETH      --      routed      down      PD      25g      --      No      No
xe20/3      ETH      --      routed      down      PD      25g      --      No      No
xe20/4      ETH      --      routed      down      PD      25g      --      No      No
OcNOS#
```

```
-----
Ethernet   Type      PVID      Mode      Status    Reason   Speed  Port  Ctl  Br/Bu  Loopbk
Interface                                     Ch #
-----
ce0        ETH      --      routed      up        none     100g   --    No   No    No
ce1        ETH      --      routed      up        none     40g    --    No   No    No
ce2        ETH      --      routed      up        none     100g   --    No   No    No
ce3/1      ETH      --      routed      down      PD       10g    --    No   No    No
ce3/2      ETH      --      routed      down      PD       10g    --    No   No    No
ce3/3      ETH      --      routed      down      PD       10g    --    No   No    No
ce3/4      ETH      --      routed      down      PD       10g    --    No   No    No
ce4        ETH      --      routed      down      PD       100g   --    No   No    No
ce5        ETH      --      routed      down      PD       100g   --    No   No    No
```

Unconfigure Port Breakout through Global Level

To revert ports to the default configuration:

1. Enter the configuration mode:

```
ocnos#configure terminal
```

2. Remove the breakout setting to combine the breakout port back to original port as (ce20):

```
ocnos(config)#no port ce20 breakout
```

3. Save the configuration to view the changes:

```
ocnos(config)#commit
```

Validation

To verify the port breakout unconfiguration, execute the following command:

```
OcNOS#show run int ce20
!
interface ce20
!
OcNOS#sh run int ce20/1
% Can't find interface ce20/1.
OcNOS#sh run int ce3/2
% Can't find interface ce20/2.
OcNOS#sh run int ce20/3
% Can't find interface ce20/3.
OcNOS#sh run int ce20/4
% Can't find interface ce20/4.

OcNOS#sh int br

Codes: ETH - Ethernet, LB - Loopback, AGG - Aggregate, MLAG - MLAG Aggregate
FR - Frame Relay, TUN -Tunnel, PBB - PBB Logical Port, VP - Virtual Port
CVP - Channelised Virtual Port, METH - Management Ethernet, UNK- Unknown
ED - ErrDisabled, PD - Protocol Down, AD - Admin Down, IA - InActive
PD(Min L/B) - Protocol Down Min-Links/Bandwidth
DV - DDM Violation, NA - Not Applicable
NOM - No operational members, PVID - Port Vlan-id
Ctl - Control Port (Br-Breakout/Bu-Bundle)
HD - ESI Hold Timer Down

-----
Ethernet  Type          PVID  Mode          Status Reason  Speed Port  Ctl Br/Bu  Loopbk
Interface                                     Ch #
-----
ce0       ETH            --    routed        up     none   100g  --    No  No
ce1       ETH            --    routed        up     none   40g   --    No  No
ce2       ETH            --    routed        up     none   100g  --    No  No
ce3       ETH            --    routed        down   PD     100g  --    No  No
ce4       ETH            --    routed        down   PD     100g  --    No  No
ce5       ETH            --    routed        down   PD     100g  --    No  No
ce6       ETH            --    routed        down   PD     100g  --    No  No
```

Configuration for Interface-Level Breakout

This method configures the port breakout without requiring a system reload. Perform the following to configure port breakout on a supported device:

1. Enter the configuration mode:

```
ocnos#configure terminal
```

2. Configure 100g port **ce2/1** to breakout into 4x10g ports such as ce2/1,ce2/2,ce2/3,ce2/4:

```
ocnos(config)# interface ce2/1
ocnos(config-if)# port breakout enable 4X10g
```



Note: Similarly, you can configure all breakout possibilities.

3. Save the configuration view the changes:

```
ocnos(config)#commit
```

Validation

To verify the port breakout configuration, execute the following command:

```
OcNOS#show interface brief
```

```
Codes: ETH - Ethernet, LB - Loopback, AGG - Aggregate, MLAG - MLAG Aggregate
FR - Frame Relay, TUN -Tunnel, PBB - PBB Logical Port, VP - Virtual Port
CVP - Channelised Virtual Port, METH - Management Ethernet, UNK- Unknown
ED - ErrDisabled, PD - Protocol Down, AD - Admin Down, IA - InActive
PD(Min L/B) - Protocol Down Min-Links/Bandwidth
OTD - Object Tracking Down
DV - DDM Violation, NA - Not Applicable
NOM - No operational members, PVID - Port Vlan-id
Ctl - Control Port (Br-Breakout/Bu-Bundle)
HD - ESI Hold Timer Down
```

Ethernet Port Interface	Type	PVID	Mode	Status	Reason	Speed	Ch #	Br	Yes
	Ctl Br/Bu	Loopbk							
ce1/1	ETH	--	routed	up	none	10g	--	Br	Yes
ce1/2	ETH	--	routed	up	none	10g	--	No	No
ce1/3	ETH	--	routed	up	none	10g	--	No	No
ce1/4	ETH	--	routed	up	none	10g	--	No	No
ce2/1	ETH	--	routed	up	none	10g	--	Br	Yes
ce2/2	ETH	--	routed	up	none	10g	--	No	No
ce2/3	ETH	--	routed	up	none	10g	--	No	No
ce2/4	ETH	--	routed	up	none	10g	--	No	No

Unconfigure Port Breakout through Interface Level

To revert ports to the default configuration:

1. Enter the configuration mode:

```
ocnos#configure terminal
```

2. Select the specific interface (**ce2/1**):

```
ocnos(config)#interface ethernet ce2/1
```

3. Remove the breakout setting to combine the breakout port back to original port as (ce2/1):

```
ocnos(config-if)#no port breakout enable 4x10g
```

4. Save the configuration to view the changes:

```
ocnos(config)#commit
```

Validation

To verify the port breakout configuration, execute the following command:

```
OcNOS#show interface brief
```

```
Codes: ETH - Ethernet, LB - Loopback, AGG - Aggregate, MLAG - MLAG Aggregate
FR - Frame Relay, TUN -Tunnel, PBB - PBB Logical Port, VP - Virtual Port
CVP - Channelised Virtual Port, METH - Management Ethernet, UNK- Unknown
ED - ErrDisabled, PD - Protocol Down, AD - Admin Down, IA - InActive
PD(Min L/B) - Protocol Down Min-Links/Bandwidth
OTD - Object Tracking Down
DV - DDM Violation, NA - Not Applicable
NOM - No operational members, PVID - Port Vlan-id
Ctl - Control Port (Br-Breakout/Bu-Bundle)
HD - ESI Hold Timer Down
```

Ethernet Port Interface	Type	PVID	Mode	Status	Reason	Speed	Ch #	Br	No
	Ctl Br/Bu	Loopbk							
ce1/1	ETH	--	routed	up	none	100g	--	Br	No
ce1/2	ETH	--	routed	down	IA	--	--	No	No
ce1/3	ETH	--	routed	down	IA	--	--	No	No
ce1/4	ETH	--	routed	down	IA	--	--	No	No
ce2/1	ETH	--	routed	down	PD	100g	--	Br	No
ce2/2	ETH	--	routed	down	IA	--	--	No	No
ce2/3	ETH	--	routed	down	IA	--	--	No	No
ce2/4	ETH	--	routed	down	IA	--	--	No	No

SECURITY MANAGEMENT COMMAND REFERENCE

Access Control List Commands (XGS)	1228
access-list logging cache-size	1230
access-list logging rate-limit	1231
arp access-group	1232
arp access-list	1233
arp access-list filter	1234
arp access-list remark	1236
arp access-list request	1237
arp access-list resequence	1239
arp access-list response	1240
clear access-list	1242
clear access-list log-cache	1243
clear arp access-list	1244
clear ip access-list	1245
clear ipv6 access-list	1246
clear mac access-list	1247
ip access-group	1248
ip access-list	1251
ip access-list default	1252
ip access-list filter	1253
ip access-list fragments	1257
ip access-list icmp	1258
ip access-list remark	1264
ip access-list resequence	1265
ip access-list tcp udp	1266
ipv6 access-group	1274
ipv6 access-list	1276
ipv6 access-list default	1278
ipv6 access-list filter	1279
ipv6 access-list fragments	1283
ipv6 access-list icmpv6	1284
ipv6 access-list remark	1289
ipv6 access-list resequence	1290
ipv6 access-list sctp	1291
ipv6 access-list tcp udp	1295

line vty	1304
mac access-group	1305
mac access-list	1307
mac access-list default	1308
mac access-list filter	1309
mac access-list remark	1312
mac access-list resequence	1313
show access-list log-cache	1314
show access-lists	1315
show arp access-lists	1317
show ip access-lists	1318
show ipv6 access-lists	1319
show mac access-lists	1320
show running-config access-list	1321
show running-config aclmgr	1322
show running-config ipv6 access-list	1323
Access Control List Commands (Standard)	1324
ip access-list standard	1325
ip access-list standard filter	1326
ipv6 access-list standard	1327
ipv6 access-list standard filter	1328
DHCP Snooping Commands	1329
debug ip dhcp snooping	1330
ip dhcp snooping arp-inspection validate	1331
ip dhcp snooping binding bridge	1333
ip dhcp snooping database	1335
renew ip dhcp snooping binding database	1336
show debugging ip dhcp snooping	1337
show ip dhcp snooping arp-inspection statistics bridge	1338
show ip dhcp snooping bridge	1339
show ip dhcp snooping binding bridge	1341
IP Source Guard Commands	1343
hardware-profile filter ipsg	1344
hardware-profile filter ipsg-ipv6	1345
ip verify source dhcp-snooping-vlan	1346
Internet Protocol Security Commands	1347
crypto ipsec transform-set	1348
crypto map	1351
mode	1352
set peer	1353

set session-key	1354
set transform-set	1356
sequence	1357
show crypto ipsec transform-set	1358

Access Control List Commands (XGS)

This chapter is a reference for the Access Control List (ACL) commands for XGS devices (Trident II, Trident II+, and Tomahawk):

access-list logging cache-size	1230
access-list logging rate-limit	1231
arp access-group	1232
arp access-list	1233
arp access-list filter	1234
arp access-list remark	1236
arp access-list request	1237
arp access-list resequence	1239
arp access-list response	1240
clear access-list	1242
clear access-list log-cache	1243
clear arp access-list	1244
clear ip access-list	1245
clear ipv6 access-list	1246
clear mac access-list	1247
ip access-group	1248
ip access-list	1251
ip access-list default	1252
ip access-list filter	1253
ip access-list fragments	1257
ip access-list icmp	1258
ip access-list remark	1264
ip access-list resequence	1265
ip access-list tcp udp	1266
ipv6 access-group	1274
ipv6 access-list	1276
ipv6 access-list default	1278
ipv6 access-list filter	1279
ipv6 access-list fragments	1283
ipv6 access-list icmpv6	1284
ipv6 access-list remark	1289
ipv6 access-list resequence	1290
ipv6 access-list sctp	1291
ipv6 access-list tcp udp	1295
line vty	1304

mac access-group	1305
mac access-list	1307
mac access-list default	1308
mac access-list filter	1309
mac access-list remark	1312
mac access-list resequence	1313
show access-list log-cache	1314
show access-lists	1315
show arp access-lists	1317
show ip access-lists	1318
show ipv6 access-lists	1319
show mac access-lists	1320
show running-config access-list	1321
show running-config aclmgr	1322
show running-config ipv6 access-list	1323

access-list logging cache-size

Use this command to set the ACL logging table size.

Use the `no` form of this command to set the table size to its default (1000).

Command Syntax

```
access-list logging cache-size <1000-10000>  
no access-list logging cache-size
```

Parameters

<1000-10000>

Maximum number of cache entries

Default

By default, the logging table size is 1000.

Command Mode

Configuration mode

Applicability

This command was introduced before OcNOS version 1.3.

Examples

```
#configure terminal  
(config)#access-list logging cache-size 2000  
(config)#end
```

access-list logging rate-limit

Use this command to set the rate limit for logging ACL denied packets.

Use the `no` form of this command to reset the rate to its default (200).

Command Syntax

```
access-list logging rate-limit <0-1000>  
no access-list logging rate-limit
```

Parameters

<0-1000>

Packets per second

Default

By default, the rate is 200 packets per second.

Command Mode

Configuration mode

Applicability

This command was introduced before OcNOS version 1.3.

Examples

```
#configure terminal  
(config)#access-list logging rate-limit 500  
(config)#end
```

arp access-group

Use this command to attach an ARP access list to an interface to filter incoming ARP packets.

When you attach an ARP access list to a VLAN or **LAG**¹ interface as well as to a physical interface that is a member of that LAG and/or VLAN interface, the priority order is:

1. VLAN interface
2. LAG interface
3. Physical interface

For example, if you attach access lists to both a LAG interface and a physical interface that is a member of that LAG, matching traffic rules are applied to the LAG interface, but not to the physical interface.

Use the **no** form of this command to detach an ARP access group.

- An ARP access-list is supported only on switch ports.
- To attach an ARP access-group to an interface, the **ingress-arp** TCAM group should be enabled. See the [hardware-profile filter \(XGS\) \(page 1704\)](#) command for more details.

Command Syntax

```
arp access-group NAME in
no arp access-group NAME in
```

Parameters

NAME

ARP Access list name

Command Mode

Interface mode

Applicability

This command was introduced in OcNOS version 1.3.6

Example

```
#configure terminal
(config)#arp access-list arp1
(config-arp-acl)#permit ip any mac any
(config-arp-acl)#exit

(config)#interface xe1
(config-if)#arp access-group arp1 in
(config-if)#exit

(config)#interface xe1
(config-if)#no arp access-group arp1 in
(config-if)#exit
```

¹Link Aggregation Group

arp access-list

Use this command to define a named ARP access control list (ACL) that determines whether to accept or drop an incoming ARP packet based on the sender or target IP address, sender or target MAC address, ARP type.

An ACL is made up of one or more ACL specifications. You can repeat this command and add multiple specifications. Each time you give this command, the specification is added to the end of the list.

Each packet that arrives at the device is compared to each specification in each ACL in the order that they are sequenced. The device continues to look until it has a match. If no match is found and the device reaches the end of the list, the packet is denied by default. For this reason, place the most frequently occurring specifications at the top of the list.

The device stops checking the specifications after a match occurs.

There is an implied deny specification for traffic that is not permitted. The implied specification can be updated to permit if the use-case is to deny a certain set of ARP traffic. A single-entry ACL with only one deny specification is the same as denying all traffic. You must have at least one permit specification in an ACL or all traffic is blocked.

Use the no form of this command to remove an ACL specification.



Note: An ARP access list is supported only on switch ports.

Command Syntax

```
arp access-list NAME
no arp access-list NAME
```

Parameters

NAME

ARP Access list name

Command Mode

Configure mode

Applicability

This command was introduced in OcNOS version 3.0.

Example

```
#configure terminal
(config)#arp access-list ARP_ACL1
(config-arp-acl)#exit
(config)#no arp access-list ARP_ACL1
```

arp access-list filter

Use this command to configure access control entry in ARP access control list (ACL).

This determines whether to accept or drop an ARP packet based on the configured match criteria. Use the no form of this command to remove an ACL specification.



Note: Configuring the same filter again with a change of sequence number or change of action results in an update of sequence number or filter action.

Command Syntax

```
(<1-268435453>|) (deny|permit) (request |) ip (A.B.C.D/M|A.B.C.D A.B.C.D|host A.B.C.D|any)
mac (any | (XX-XX-XX-XX-XXXX|XX:XX:XX:XX:XX:XX|XXXX.XXXX.XXXX) (XX-XX-XX-XX-
XXXX|XX:XX:XX:XX:XX:XX|XXXX.XXXX.XXXX) |
host (XX-XX-XX-XX-XXXX|XX:XX:XX:XX:XX:XX|XXXX.XXXX.XXXX) )
(any | (XX-XX-XX-XX-XXXX|XX:XX:XX:XX:XX:XX|XXXX.XXXX.XXXX) (XX-XX-XX-XX-
XXXX|XX:XX:XX:XX:XX:XX|XXXX.XXXX.XXXX)
| host (XX-XX-XX-XX-XXXX|XX:XX:XX:XX:XX:XX|XXXX.XXXX.XXXX) )
(vlan <1-4094>|) (inner-vlan <1-4094>|) (log|) (sample|)

no (<1-268435453>|) (deny|permit) (request |) ip (A.B.C.D/M|A.B.C.D A.B.C.D|host A.B.C.D|any)
mac (any | (XX-XX-XX-XX-XXXX|XX:XX:XX:XX:XX:XX|XXXX.XXXX.XXXX) (XX-XX-XX-XX-
XXXX|XX:XX:XX:XX:XX:XX|XXXX.XXXX.XXXX)
| host (XX-XX-XX-XX-XXXX|XX:XX:XX:XX:XX:XX|XXXX.XXXX.XXXX) )
(any | (XX-XX-XX-XX-XXXX|XX:XX:XX:XX:XX:XX|XXXX.XXXX.XXXX) (XX-XX-XX-XX-
XXXX|XX:XX:XX:XX:XX:XX|XXXX.XXXX.XXXX)
| host (XX-XX-XX-XX-XXXX|XX:XX:XX:XX:XX:XX|XXXX.XXXX.XXXX) )
(vlan <1-4094>|) (inner-vlan <1-4094>|) (log|) (sample|)
```

Parameters

deny

Drop the packet.

permit

Accept the packet.

<1-268435453>

ARP ACL sequence number.

request

RP request type

A.B.C.D/M

Source IP prefix and length.

A.B.C.D A.B.C.D

Source IP address and mask.

host A.B.C.D

Single source host IP address.

any

Match any source IP address.

any

Any source/destination.

XX-XX-XX-XX-XX-XX

Source MAC address (Option 1).

XX:XX:XX:XX:XX:XX

Source MAC address (Option 2).

XXXX.XXXX.XXXX

Source MAC address (Option 3).

XX-XX-XX-XX-XX-XX

Source wildcard (Option 1).

XX:XX:XX:XX:XX:XX

Source wildcard (Option 2).

XXXX.XXXX.XXXX

Source wildcard (Option 3).

vlan <1-4094>

VLAN identifier.

inner-vlan<1-4094>

Inner VLAN identifier.

log

Log the packets matching the filter (in-direction only).

sample

Sample the packets matching the filter (in-direction only).

Command Mode

ARP access-list mode

Applicability

This command was introduced in OcNOS version 1.3.6

Example

```
#configure terminal
(config)#arp access-list ARP_ACL1
(config-arp-acl)#15 permit ip host 2.2.2.1 mac any inner-vlan 3
(config-arp-acl)#no 15
```

arp access-list remark

Use this command to add a description to a named ARP access control list (ACL).

Use the **no** form of this command to remove an ACL description.

Command Syntax

```
remark LINE
no remark
```

Parameters

LINE

ACL description up to 100 characters.

Command Mode

ARP access-list mode

Applicability

This command was introduced in OcNOS version 3.0.

Example

```
#configure terminal
(config)#arp access-list arp1
(config-arp-acl)#remark Permit arp request packets
(config-arp-acl)#no remark
(config-arp-acl)#exit
```

arp access-list request

Use this command to configure ARP access control entry in an ARP access control list (ACL).

This command determines whether to accept or drop a packet based on the configured match criteria.

Use the **no** form of this command to remove an ACL specification.



Note: Configuring the same filter again with a change of sequence number or change of action will result in updating the sequence number or filter action.

Command Syntax

```
(<1-268435453>|) (deny|permit) (request |) ip (A.B.C.D/M|A.B.C.D A.B.C.D|host A.B.C.D|any)
mac (any | ((XX-XX-XX-XX-XX-XX|XX:XX:XX:XX:XX:XX|XXXX.XXXX.XXXX) (XX-XX-XX-XX-XX-
XX|XX:XX:XX:XX:XX:XX|XXXX.XXXX.XXXX) |
(host (XX-XX-XX-XX-XX-XX|XX:XX:XX:XX:XX:XX|XXXX.XXXX.XXXX))) (vlan <1-4094>|) (inner-vlan <1-4094>|)
```

```
no (<1-268435453>|) (deny|permit) (request |) ip (A.B.C.D/M|A.B.C.D A.B.C.D|host A.B.C.D|any)
mac (any | ((XX-XX-XX-XX-XX-XX|XX:XX:XX:XX:XX:XX|XXXX.XXXX.XXXX) (XX-XX-XX-XX-XX-
XX|XX:XX:XX:XX:XX:XX|XXXX.XXXX.XXXX) |
(host (XX-XX-XX-XX-XX-XX|XX:XX:XX:XX:XX:XX|XXXX.XXXX.XXXX))) (vlan <1-4094>|) (inner-vlan <1-4094>|)
```

Parameters

<1-268435453>

ARP ACL sequence number.

deny

Drop the packet.

permit

Accept the packet.

request

ARP request.

ip

Internet Protocol (IP).

A.B.C.D/M

Source IP prefix and length.

A.B.C.D A.B.C.D

Source IP address and mask.

host A.B.C.D

A single source host IP address.

any

Match any source IP address.

mac

MAC address configuration.

any

Match any source mac address.

XX-XX-XX-XX-XX-XX

Source MAC address (Option 1).

XX:XX:XX:XX:XX:XX

Source MAC address (Option 2).

XXXX.XXXX.XXXX

Source MAC address (Option 3).

XX-XX-XX-XX-XX-XX

Source wildcard (Option 1).

XX:XX:XX:XX:XX:XX

Source wildcard (Option 2).

XXXX.XXXX.XXXX

Source wildcard (Option 3).

host (XX-XX-XX-XX-XX-XX)

A single source host MAC address.

vlan <1-4094>

VLAN identifier.

inner-vlan <1-4094>

Inner VLAN identifier.

Command Mode

ARP access-list mode

Applicability

This command was introduced in OcNOS version 3.0.

Examples

```
#configure terminal
(config)#arp access-list arp1
(config-arp-acl)#10 permit request ip 1.1.1.0/24 mac 0000.0000.0001 FFFF.FFFF.FFF0
(config-arp-acl)#no 10
```

arp access-list resequence

Use this command to modify the sequence numbers of an ARP access list.



Note: IP Infusion Inc. recommends to use a non-overlapping sequence space for a new sequence number set to avoid unexpected rule matches during transition.



Note: Re-sequencing an ACL attached to a management interface clears the ACL counters associated to it.

Command Syntax

```
resequence <1-268435453> INCREMENT
```

Parameters

<1-268435453>

Starting sequence number.

INCREMENT

Sequence number increment steps.

Command Mode

ARP access-list mode

Applicability

This command was introduced in OcNOS version 3.0.

Example

```
#configure terminal
(config)#arp access-list arp1
(config-arp-acl)#resequence 15 15
```

arp access-list response

Use this command to configure an ARP access control entry in an ARP access control list (ACL).

This command determines whether to accept or drop an ARP response packet based on the configured match criteria.

Use the **no** form of this command to remove an ACL specification.



Note: Configuring the same filter again with a change of sequence number or change of action will result in updating the sequence number or filter action.

Command Syntax

```
(<1-268435453>|) (deny|permit) response ip (A.B.C.D/M|A.B.C.D A.B.C.D|host A.B.C.D|any)
(A.B.C.D/M|A.B.C.D A.B.C.D|host A.B.C.D|any)
mac (any | (XX-XX-XX-XX-XXXX|XX:XX:XX:XX:XX:XX|XXXX.XXXX.XXXX) (XX-XX-XX-XX-
XXXX|XX:XX:XX:XX:XX:XX|XXXX.XXXX.XXXX)
| host (XX-XX-XX-XX-XXXX|XX:XX:XX:XX:XX:XX|XXXX.XXXX.XXXX) )
(any | (XX-XX-XX-XX-XXXX|XX:XX:XX:XX:XX:XX|XXXX.XXXX.XXXX) (XX-XX-XX-XX-
XXXX|XX:XX:XX:XX:XX:XX|XXXX.XXXX.XXXX)
| host (XX-XX-XX-XX-XXXX|XX:XX:XX:XX:XX:XX|XXXX.XXXX.XXXX) )
(any | (XX-XX-XX-XX-XXXX|XX:XX:XX:XX:XX:XX|XXXX.XXXX.XXXX) (XX-XX-XX-XX-
XXXX|XX:XX:XX:XX:XX:XX|XXXX.XXXX.XXXX)
| host (XX-XX-XX-XX-XXXX|XX:XX:XX:XX:XX:XX|XXXX.XXXX.XXXX) )
(any | (XX-XX-XX-XX-XXXX|XX:XX:XX:XX:XX:XX|XXXX.XXXX.XXXX) (XX-XX-XX-XX-
XXXX|XX:XX:XX:XX:XX:XX|XXXX.XXXX.XXXX)
| host (XX-XX-XX-XX-XXXX|XX:XX:XX:XX:XX:XX|XXXX.XXXX.XXXX) ) (vlan <1-4094>|) (inner-vlan <1-4094>|)
(log|) (sample|)

no (<1-268435453>|) (deny|permit) response ip (A.B.C.D/M|A.B.C.D A.B.C.D|host A.B.C.D|any)
(A.B.C.D/M|A.B.C.D A.B.C.D|host A.B.C.D|any)
mac (any | (XX-XX-XX-XX-XXXX|XX:XX:XX:XX:XX:XX|XXXX.XXXX.XXXX) (XX-XX-XX-XX-
XXXX|XX:XX:XX:XX:XX:XX|XXXX.XXXX.XXXX)
| host (XX-XX-XX-XX-XXXX|XX:XX:XX:XX:XX:XX|XXXX.XXXX.XXXX) )
(any | (XX-XX-XX-XX-XXXX|XX:XX:XX:XX:XX:XX|XXXX.XXXX.XXXX) (XX-XX-XX-XX-
XXXX|XX:XX:XX:XX:XX:XX|XXXX.XXXX.XXXX)
| host (XX-XX-XX-XX-XXXX|XX:XX:XX:XX:XX:XX|XXXX.XXXX.XXXX) )
(any | (XX-XX-XX-XX-XXXX|XX:XX:XX:XX:XX:XX|XXXX.XXXX.XXXX) (XX-XX-XX-XX-
XXXX|XX:XX:XX:XX:XX:XX|XXXX.XXXX.XXXX)
| host (XX-XX-XX-XX-XXXX|XX:XX:XX:XX:XX:XX|XXXX.XXXX.XXXX) )
(any | (XX-XX-XX-XX-XXXX|XX:XX:XX:XX:XX:XX|XXXX.XXXX.XXXX) (XX-XX-XX-XX-
XXXX|XX:XX:XX:XX:XX:XX|XXXX.XXXX.XXXX)
| host (XX-XX-XX-XX-XXXX|XX:XX:XX:XX:XX:XX|XXXX.XXXX.XXXX) ) (vlan <1-4094>|) (inner-vlan <1-4094>|)
(log|) (sample|)
```

Parameters

<1-268435453>

ARP ACL sequence number.

deny

Drop the packet.

permit

Accept the packet.

response

ARP response

A.B.C.D/M

Source/destination IP prefix and length.

A.B.C.D A.B.C.D

Source/destination IP address and mask.

host A.B.C.D

A single source/destination host IP address.

any

Match any source/destination IP address.

mac

MAC address configuration.

any

Match any source/destination MAC address.

XX-XX-XX-XX-XX

Source/destination MAC address (Option 1).

XX:XX:XX:XX:XX

Source/destination MAC address (Option 2).

XXXX.XXXX.XXXX

Source/destination MAC address (Option 3).

XX-XX-XX-XX-XX

Source/destination wildcard (Option 1).

XX:XX:XX:XX:XX

Source/destination wildcard (Option 2).

XXXX.XXXX.XXXX

Source/destination wildcard (Option 3).

vlan <1-4094>

VLAN identifier.

inner-vlan <1-4094>

Inner VLAN identifier.

log

Log the packets matching the filter (in-direction only). sample Sample the packets matching the filter (in-direction only).

sample

Sample the packets matching the filter (in-direction only).

Command Mode

ARP access-list mode

Applicability

This command was introduced in OcNOS version 1.3.6

Example

```
#configure terminal
(config)#arp access-list ARP_ACL1
(config-arp-acl)#50 permit response ip host 2.2.2.1 any mac any any vlan 2
(config-arp-acl)#no 50 permit response ip host 2.2.2.1 any mac any any vlan 2
```

clear access-list

Use this command to clear the access-list counters.

Command Syntax

```
clear access-list (NAME|) counters
```

Parameters

NAME

Access-list name.

Command Mode

Execution mode and Privileged execution mode

Applicability

This command was introduced before OcNOS version 1.3.

Examples

```
#clear access-list counters
```

clear access-list log-cache

Use this command to clear the access-list logging table.

Command Syntax

```
clear access-list log-cache
```

Parameters

None

Command Mode

Execution mode and Privilege exec mode

Applicability

This command was introduced before OcNOS version 1.3

Examples

```
#clear access-list log-cache
```

clear arp access-list

Use this command to clear the ARP access-list counters.

Command Syntax

```
clear arp access-list (NAME|) counters
```

Parameters

NAME

ARP access list name

Command Mode

Execution mode and Privileged execution mode

Applicability

This command was introduced in .OcNOS version 1.3.6

Example

```
#clear arp access-list counters
```

clear ip access-list

Use this command to clear the IP access-list counters.

Command Syntax

```
clear ip access-list (NAME|) counters
```

Parameters

NAME

Access-list name.

Command Mode

Execution mode and Privileged execution mode

Applicability

This command was introduced before OcNOS version 1.3.

Examples

```
#clear ip access-list counters
```

clear ipv6 access-list

Use this command to clear the IPv6 access-list counters.

Command Syntax

```
clear ipv6 access-list (NAME|) counters
```

Parameters

NAME

Access-list name.

Command Mode

Execution mode and Privileged execution mode

Applicability

This command was introduced before OcNOS version 1.3.

Examples

```
#clear ipv6 access-list counters
```

clear mac access-list

Use this command to clear the MAC access-list counters.

Command Syntax

```
clear mac access-list (NAME|) counters
```

Parameters

NAME

Access-list name.

Command Mode

Execution mode and Privileged execution mode

Applicability

This command was introduced before OcNOS version 1.3.

Examples

```
#clear mac access-list counters
```

ip access-group

Use this command to attach an IP access list to an interface or terminal line to filter incoming or outgoing IP packets.

The **time-range** parameter is optional. If used, the access-group is tied to the timer specified.

After the access-group has been configured with the time-range, to detach the access-group from the time-range, use the **no** form of this command with a time-range parameter as shown in the syntax and examples below.

To delete the access-group, use the **no** form of this command without a time-range.



Note: An egress IP ACL is supported on physical and lag interfaces only. An egress IP ACL will match only routed traffic and not switched traffic. VLAN and inner-VLAN options in ACL rules will match incoming packet VLANs even when ACL attached at egress.



Note: Egress TCAMs do not auto-expand beyond 256 entries if any entry includes a policer action. Therefore, the total number of configurable entries in the egress direction is limited to 256.

Command Syntax

```
ip access-group NAME (in|out) (time-range TR_NAME|)
no ip access-group NAME (in|out) (time-range TR_NAME|)
```

Parameter

NAME

Access list name.

in

Filter incoming packets

out

Filter outgoing packets.

TR_NAME

Time range name set with the [time-range \(page 1691\)](#) command.

Command Mode

Line mode and Interface mode

Applicability

This command was introduced before . OcNOS version 1.3The **time-range** parameter was added in OcNOS version 5.0.

Examples

```
#configure terminal
(config)#ip access-list mylist
(config-ip-acl)#permit ip any any
(config-ip-acl)#exit
```

```
(config)#hardware-profile filter ingress-ipv4-ext enable

(config)#interface xe3
(config-if)#ip access-group mylist in
(config-if)#exit

(config)#interface xe3
(config-if)#no ip access-group mylist in time-range TIMER1
(config-if)#exit

(config)#line vty
(config-all-line)#no ip access-group mylist in
```

Usage: VLANs and LAGs

When you attach an access list to a VLAN interface or **LAG**¹ interface as well as to a physical interface that is a member of that LAG and/or VLAN interface, the priority order is:

1. VLAN interface
2. LAG interface
3. Physical interface

For example, if you attach access lists to both a LAG interface and a physical interface that is a member of that LAG, matching traffic rules are applied to the LAG interface, but not to the physical interface.

Usage: TCAM Groups

An access-group in the egress direction uses the TCAM group used by the QoS output service policy. Therefore, actions are unpredictable when conflicting matches are configured on same interface. IP Infusion Inc. recommends to avoid such a configuration. Otherwise, you need to configure the priority (in QoS) or the sequence number (in ACL) carefully to handle such cases.

To attach an IP ACL in the ingress direction the **ingress-ipv4** or **ingress-ipv4-ext** TCAM group needs to be enabled and to attach an IP ACL in the egress direction the **egress-ipv4** TCAM group needs to be enabled. See [thehardware-profile filter \(XGS\) \(page 1704\)](#) commands for details.

Usage: Loopback and VTY Interfaces

You can create ACLs for VTY interfaces to filter packets from management applications such as SSH, Telnet, NTP, SNMP, and SNMP traps. TCP, **UDP**², and **ICMP**³ are supported.



Note: Loopback and VTY ACLs are mutually exclusive. If you set up one, you cannot set up the other.

For an ACL for a loopback interface, you create the ACL, configure it with rules, and associate the ACL with a loopback interface:

```
...
(config)#interface lo
(config-if)#ip access-group loopback in
```

¹Link Aggregation Group

²User Datagram Protocol

³Internet Control Message Protocol (ICMP) is a fundamental protocol used in networking to relay error messages and operational information.

For an ACL for VTY, you create the ACL, configure it with rules, and associate the ACL to the terminal line in line mode.

```
...  
...  
(config)#line vty  
(config-all-line)#ip access-group vty in
```

Loopback and VTY ACLs do not support the following:

- The default rule **deny a11**. You must explicitly set up a **deny a11** rule based on your requirements.
- VLAN-specific rules.
- Rules with TCP flags.
- Rules with **dscp**, **fragments**, **log**, **precedence**, and **sample** parameters.

Usage: Timed ACL on interfaces

You create a timer range that is identified by a name and configured with a start time, end time, and frequency. Once you create the time range, you can tie the ACL configuration to the time-range object. This allows you to create an access group that is enabled when the timer has started and disabled when the timer ends. You can also disassociate an access group from the timer if needed.

ip access-list

Use this command to define a named access control list (ACL) that determines whether to accept or drop an incoming IP packet based on specifications configured under the ACL. An ACL is made up of one or more ACL specifications.

Each packet that arrives at the device is compared to each specification in each ACL in the order that they are defined. The device continues to look until it has a match. If no match is found and the device reaches the end of the list, the packet is denied by default. For this reason, place the most frequently occurring specifications at the top of the list.

The device stops checking the specifications after a match occurs.

There is an implied deny specification for traffic that is not permitted. Implied specification can be updated to permit if the use-case is to deny a certain set of traffic.

Use the **no** form of this command to remove an ACL.

Command Syntax

```
ip access-list NAME
no ip access-list NAME
```

Parameters

NAME

Access-list name.

Default

No default value is specified

Command Mode

Configure mode

Applicability

This command was introduced before OcNOS version 1.3.

Examples

```
#configure terminal
(config)#ip access-list ip-acl-01
```

ip access-list default

Use this command to modify the default rule action of access-list. Default rule is applicable only when access-list is attached to interface. Default rule will have the lowest priority and only the IP packets not matching any of the user defined rules match default rule.

Command Syntax

```
default (deny-all|permit-all) (log|) (sample|)
```

Parameters

deny-all

Drop all packets.

permit-all

Accept all packets.

log

Log the packets matching the filter (in-direction only). sample Sample the packets matching the filter (in-direction only).

sample

Sample the packets matching the filter (in-direction only).

Default

None

Command Mode

IP access-list mode

Applicability

This command was introduced before OcNOS version 1.3.

Examples

```
#configure terminal
(config)#ip access-list ip-acl-01
(config-ip-acl)#default permit-all
```

```
(config-ip-acl)#default permit-all sample
```

ip access-list filter

Use this command to configure access control entry in an access control list (ACL).

This determines whether to accept or drop an IP packet based on the configured match criteria.

Use the **no** form of this command to remove an ACL specification. ACL specification can be removed using the sequence number as well.



Note: Configuring the same filter again with change of sequence number or change of action results in update of sequence number or filter action.

Command Syntax

```
(<1-268435453>|) (deny|permit) (<0-255>|ahp|any|eigrp|esp|gre|ipip|ipcomp|ipv6ip |ospf|pim|rsvp|vrrp)
(A.B.C.D/ M|A.B.C.D A.B.C.D|host A.B.C.D|any) (A.B.C.D/M|A.B.C.D A.B.C.D|host A.B.C.D|any) (dscp (<0-
63>|af11| af12| af13| af21| af22| af23| af31|af32| af33| af41| af42| af43| cs1| cs2| cs3| cs4|
cs5|cs6| cs7| default| ef )) (precedence (<0-7>| critical| flash | flashoverride| immediate|
internet| network| priority| routine)) (vlan <1-4094>|) (inner-vlan <1-4094>|)
no (<1-268435453>|) (deny|permit) (<0-255> |ahp | any | eigrp | esp | gre | ipip | ipcomp | ipv6ip |
ospf | pim | rsvp| vrrp) (A.B.C.D/ M|A.B.C.D A.B.C.D | host A.B.C.D|any) (A.B.C.D/M|A.B.C.D
A.B.C.D|host A.B.C.D|any) (dscp (<0-63> |af11| af12| af13| af21| af22| af23| af31|af32| af33| af41|
af42| af43| cs1| cs2| cs3| cs4| cs5|cs6| cs7| default| ef )) (precedence (<0-7>| critical| flash |
flashoverride| immediate| internet| network| priority| routine)) (vlan <1-4094>|) (inner-vlan <1-
4094>|)
no (<1-268435453>)
```

Parameters

<1-268435453>

IPv4 ACL sequence number.

deny

Drop the packet.

permit

Accept the packet.

<0-255>

IANA assigned protocol number.

any

Any protocol packet.

ahp

Authentication Header packet.

eigrp

Enhanced Interior Gateway Routing Protocol packet.

esp

Encapsulating Security Payload packet.

gre

Generic Routing Encapsulation packet.

ipip

IPv4 over IPv4 encapsulation packet.

ipcomp

IP Payload Compression Protocol packet.

ipv6ip

IPv6 over IPv4 encapsulation packet.

ospf

Open Shortest Path First packet.

pim

Protocol Independent Multicast packet

rsvp

Resource Reservation Protocol packet.

vrrp

Virtual Router Redundancy Protocol packet.

A.B.C.D/M

Source IP prefix and length.

A.B.C.D A.B.C.D

Source IP address and mask.

host A.B.C.D

A single source host IP address.

any

Match any source IP address.

A.B.C.D/M

Destination IP prefix and length.

A.B.C.D A.B.C.D

Destination IP address and mask.

host A.B.C.D

A single destination host IP address.

any

Match any destination IP address.

dscp

Match packets with given DSCP value.

<0-63>

Enter DSCP value between 0-63.

af11

AF11 DSCP (001010) decimal value 10.

af12

AF12 DSCP (001100) decimal value 12.

af13

AF13 DSCP (001110) decimal value 14.

af21

AF21 DSCP (010010) decimal value 18.

af22

AF22 DSCP (010100) decimal value 20.

af23

AF23 DSCP (010110) decimal value 22.

af31

AF31 DSCP (011010) decimal value 26.

af32

AF32 DSCP (011100) decimal value 28.

af33

AF33 DSCP (011110) decimal value 30.

af41

AF41 DSCP (100010) decimal value 34

af42

AF42 DSCP (100100) decimal value 36.

af43

AF43 DSCP (100110) decimal value 38.

cs1

CS1 (precedence 1) DSCP (001000) decimal value 8.

cs2

CS2 (precedence 2) DSCP (010000) decimal value 16.

cs3

CS3 (precedence 3) DSCP (011000) decimal value 24.

cs4

CS4 (precedence 4) DSCP (100000) decimal value 32.

cs5

CS5 (precedence 5) DSCP (101000) decimal value 40.

cs6

CS6 (precedence 6) DSCP (110000) decimal value 48.

cs7

CS7 (precedence 7) DSCP (111000) decimal value 56.

default

Default DSCP (000000) decimal value 0.

ef

EF DSCP (101110) decimal value 46.

precedence

Match packets with given precedence value.

<0-7>

Enter precedence value 0-7.

critical

Match packets with critical precedence (5).

flash

Match packets with flash precedence (3).

flashoverride

Match packets with flash override precedence (4).

immediate

Match packets with immediate precedence (2).

internet

Match packets with internetnetwork control precedence (6).

network

Match packets with network control precedence (7).

priority

Match packets with priority precedence (1).

routine

Match packets with routine precedence (0).

vlan

Match packets with given vlan value.

<1 - 4094>

VLAN identifier.

inner-vlan

Match packets with given inner vlan value.

<1 - 4094>

VLAN identifier.

Default

None

Command Mode

IP access-list mode

Applicability

This command was introduced before OcNOS version 1.3.

Examples

```
#configure terminal(config)#ip access-list ip-acl-01
(config-ip-acl)#11 permit any 30.0.0.1 0.0.0.255 172.124.0.2 0.0.0.255
(config-ip-acl)#no 11
```

ip access-list fragments

Use this command to configure access list to deny or permit all the IP fragmented packets.

Use the no form of this command to remove an ACL specification.



Note: Configuring same filter again with change of sequence number or change of action will result in update of sequence number or filter action.

Command Syntax

```
<1-268435453>|) fragments (deny-all|permit-all) (log|) (sample|)
no <1-268435453>|) fragments (deny-all|permit-all) (log|) (sample|)
```

Parameters

deny-all

Drop the packet.

permit-all

Accept the packet.

<1-268435453>

IPv4 ACL sequence number.

fragments

Check non-initial.

log

Log the packets matching the filter (in-direction only).

sample

Sample the packets matching the filter (in-direction only).

Command Mode

IP access-list mode

Applicability

This command was introduced before OcNOS version 1.3

Examples

```
#configure terminal
(config)#ip access-list mylist
(config-ip-acl)#fragments deny-all
(config-ip-acl)#end
```

ip access-list icmp

Use this command to permit or deny **ICMP**¹ packets based on the given source and destination IP address. Even DSCP, precedence, VLAN identifier, inner VLAN identifier, and fragment number can be configured to permit or deny with the given values.

Use the **no** form of this command to remove an ACL specification.



Note: Configuring same filter again with change of sequence number or change of action will result in update of sequence number or filter action.

Command Syntax

```
(<1-268435453>|) (deny|permit) (icmp) (A.B.C.D/M|A.B.C.D A.B.C.D|host A.B.C.D|any) (A.B.C.D/M|A.B.C.D
A.B.C.D|host A.B.C.D|any) ((dscp (<0-63>|af11| af12| af13| af21| af22| af23| af31|af32| af33| af41|
af42| af43| cs1| cs2| cs3| cs4| cs5|cs6| cs7| default| ef ))| (precedence (<0-7>| critical| flash |
flashoverride|immediate| internet| network| priority| routine))) (vlan <1-4094>|) (inner-vlan <1-
4094>|)
no (<1-268435453>|) (deny|permit) (icmp) (A.B.C.D/M|A.B.C.D A.B.C.D|host A.B.C.D|any)
(A.B.C.D/M|A.B.C.D A.B.C.D|host A.B.C.D|any) (dscp (<0-63>|af11| af12| af13| af21| af22| af23|
af31|af32| af33| af41| af42| af43| cs1| cs2| cs3| cs4| cs5|cs6| cs7| default| ef ))| (precedence (<0-
7>| critical| flash | flashoverride|immediate| internet| network| priority| routine))) (vlan <1-
4094>|) (inner-vlan <1-4094>|)

(<1-268435453>|) (deny|permit) (icmp) (A.B.C.D/M|A.B.C.D A.B.C.D|host A.B.C.D|any) (A.B.C.D/M|A.B.C.D
A.B.C.D|host A.B.C.D|any) (administratively-prohibited| alternate-address| conversion-error|dod-host-
prohibited| dod-net-prohibited| echo| echo-reply|general-parameter-problem| host-isolated| host-
precedence- unreachable|host-redirect| host-tos-redirect| host-tos-unreachable| host- unknown|host-
unreachable| information-reply| information-request| mask- reply|mask-request| mobile-redirect| net-
redirect| net-tos-redirect|net-tos- unreachable| net-unreachable| network-unknown| no-room-for-
option|option-missing| packet-too-big| parameter-problem| port-unreachable|precedence-unreachable|
protocol-unreachable| reassembly-timeout| redirect|router-advertisement| router- solicitation|
source-quench|source-route-failed|time-exceeded| timestamp-reply| timestamp-request| traceroute|ttl-
exceeded|unreachable|(<0-255> (<0-255>|)))| ((dscp (<0-63>|af11| af12| af13| af21| af22| af23|
af31|af32| af33| af41| af42| af43| cs1| cs2| cs3| cs4| cs5|cs6| cs7| default| ef ))| (precedence (<0-
7>| critical| flash | flashoverride|immediate| internet| network| priority| routine))) (fragments|)
(vlan <1-4094>|) (inner-vlan <1-4094>|) (log|) (sample|) ((redirect-to-port IFNAME|)
no (<1-268435453>|) (deny|permit) (icmp) (A.B.C.D/M|A.B.C.D A.B.C.D|host A.B.C.D|any)
(A.B.C.D/M|A.B.C.D A.B.C.D|host A.B.C.D|any) (administratively- prohibited| alternate-address|
conversion-error|dod-host-prohibited| dod-net- prohibited| echo| echo-reply|general-parameter-
problem| host-isolated| host- precedence-unreachable|host-redirect| host-tos-redirect| host-tos-
unreachable| host-unknown|host-unreachable| information-reply| information-request| mask- reply|mask-
request| mobile-redirect| net-redirect| net-tos-redirect|net-tos- unreachable| net-unreachable|
network-unknown| no-room-for-option|option-missing| packet-too-big| parameter-problem| port-
unreachable|precedence-unreachable| protocol-unreachable| reassembly-timeout| redirect|router-
advertisement| router- solicitation| source-quench|source-route-failed|time-exceeded| timestamp-
reply| timestamp-request| traceroute|ttl-exceeded|unreachable|(<0-255> (<0-255>|))) ("dscp (<0-
63>|af11| af12| af13| af21| af22| af23| af31|af32| af33| af41| af42| af43| cs1| cs2| cs3| cs4|
cs5|cs6| cs7| default| ef ))| (precedence (<0-7>| critical| flash | flashoverride|immediate|
internet| network| priority| routine))) (fragments|) (vlan <1-4094>|) (inner-vlan <1-4094>|) (log|)
(sample|) ((redirect-to-port IFNAME|)
```

Parameters

<1-268435453>

IPv4 ACL sequence number.

¹Internet Control Message Protocol (ICMP) is a fundamental protocol used in networking to relay error messages and operational information.

deny

Drop the packet.

permit

Accept the packet.

icmp

Internet Control Message Protocol packet.

A.B.C.D/M

Source IP prefix and length.

A.B.C.D A.B.C.D

Source IP address and mask.

host A.B.C.D

A single source host IP address.

any

Match any source IP address.

A.B.C.D/M

Destination IP prefix and length.

A.B.C.D A.B.C.D

Destination IP address and mask.

host A.B.C.D

A single destination host IP address.

any

Match any destination IP address.

administratively-prohibited

Administratively prohibited.

alternate-address

Alternate address.

conversion-error

Datagram conversion.

dod-host-prohibited

Host prohibited.

dod-net-prohibited

Net prohibited.

echo

Echo (ping).

echo-reply

Echo reply.

general-parameter-problem

Parameter problem.

host-isolated

Host isolated.

host-precedence-unreachable

Host unreachable for precedence.

host-redirect

Host redirect.

host-tos-redirect

Host redirect for ToS.

host-tos-unreachable

Host unreachable for ToS.

host-unknown

Host unknown.

host-unreachable

Host unreachable.

information-reply

Information replies.

information-request

Information requests.

mask-reply

Mask replies.

mask-request

Mask requests.

mobile-redirect

Mobile host redirect.

net-redirect

Network redirect.

net-tos-redirect

Net redirect for ToS.

net-tos-unreachable

Network unreachable for ToS.

net-unreachable

Net unreachable.

network-unknown

Network unknown.

no-room-for-option

Parameter required but no room.

option-missing

Parameter required but not present.

packet-too-big

Fragmentation needed and DF set.

parameter-problem

All parameter problems.

port-unreachable

Port unreachable.

precedence-unreachable

Precedence cutoff.

protocol-unreachable

Protocol unreachable.

reassembly-timeout

Reassembly timeout.

redirect

All redirects.

router-advertisement

Router discovery advertisements.

router-solicitation

Router discovery solicitations.

source-quench

Source quenches.

source-route-failed

Source route failed.

time-exceeded

All time-exceeded messages.

timestamp-reply

Time-stamp replies.

timestamp-request

Time-stamp requests.

traceroute

Traceroute.

ttl-exceeded

TTL exceeded.

unreachable

All unreachables.

<0-255>

ICMP type.

<0-255>

ICMP code.

dscp

Match packets with given DSCP value.

<0-63>

Enter DSCP value between 0-63.

af11

AF11 DSCP (001010) decimal value 10.

af12

AF12 DSCP (001100) decimal value 12.

af13

AF13 DSCP (001110) decimal value 14.

af21

AF21 DSCP (010010) decimal value 18.

af22

AF22 DSCP (010100) decimal value 20.

af23

AF23 DSCP (010110) decimal value 22.

af31

AF31 DSCP (011010) decimal value 26.

af32

AF32 DSCP (011100) decimal value 28.

af33

AF33 DSCP (011110) decimal value 30.

af41

AF41 DSCP (100010) decimal value 34

af42

AF42 DSCP (100100) decimal value 36.

af43

AF43 DSCP (100110) decimal value 38.

cs1

CS1 (precedence 1) DSCP (001000) decimal value 8.

cs2

CS2 (precedence 2) DSCP (010000) decimal value 16.

cs3

CS3 (precedence 3) DSCP (011000) decimal value 24.

cs4

CS4 (precedence 4) DSCP (100000) decimal value 32.

cs5

CS5 (precedence 5) DSCP (101000) decimal value 40.

cs6

CS6 (precedence 6) DSCP (110000) decimal value 48.

cs7

CS7 (precedence 7) DSCP (111000) decimal value 56.

default

Default DSCP (000000) decimal value 0.

ef

EF DSCP (101110) decimal value 46.

precedence

Match packets with given precedence value.

<0-7>

Enter precedence value 0-7.

critical

Match packets with critical precedence (5).

flash

Match packets with flash precedence (3).

flashoverride

Match packets with flash override precedence (4).

immediate

Match packets with immediate precedence (2).

internet

Match packets with internetnetwork control precedence (6).

network

Match packets with network control precedence (7).

priority

Match packets with priority precedence (1).

routine

Match packets with routine precedence (0).

fragments

Check non-initial fragments.

vlan

Match packets with given vlan value.

<1-4094>

VLAN identifier.

inner-vlan

Match packets with given inner-vlan value.

<1-4094>

VLAN identifier.

log

Log the packets matching the filter (in-direction only). sample Sample the packets matching the filter (in-direction only).

sample

Sample the packets matching the filter (in-direction only).

redirect-to-port

Redirect the packet (in-direction only)

IFNAME

Interface name to which packet to be redirected (switchport only)

Default

None

Command Mode

IP access-list mode

Applicability

This command was introduced before OcNOS version 1.3.

Examples

```
#configure terminal
(config)#ip access-list ip-icmp
(config-ip-acl)#200 permit icmp any any
```

ip access-list remark

Use this command to add a description to a named IPv4 access control list (ACL).

Use the `no` form of this command to remove an ACL description.

Command Syntax

```
remark LINE
no remark
```

Parameters

LINE

ACL description up to 100 characters.

Default

None

Command Mode

IP access-list mode

Applicability

This command was introduced before OcNOS version 1.3.

Examples

```
#configure terminal
(config)#ip access-list mylist
(config-ip-acl)#remark permit the inside admin address
(config-ip-acl)#exit

(config)#ip access-list mylist
(config-ip-acl)#no remark
(config-ip-acl)#exit
```

ip access-list resequence

Use this command to modify sequence numbers of the IP access list specifications.



Note: Use a non-overlapping sequence space for new sequence number sets to avoid possible unexpected rule matches during transition.



Note: Re-sequencing an ACL attached to a management interface clears the ACL counters associated to it.

Command Syntax

```
resequence <1-268435453> INCREMENT
```

Parameters

<1-268435453>

Starting sequence number.

INCREMENT

Sequence number increment steps.

Default

None

Command Mode

IP access-list mode

Applicability

This command was introduced before OcNOS version 1.3.

Examples

```
#configure terminal
(config)#ip access-list mylist
(config-ip-acl)#resequence 5 5
(config-ip-acl)#end
```

ip access-list tcp|udp

Use this command to define a named access control list (ACL) that determines whether to accept or drop an incoming TCP or UDP¹ IP packet based on the specified match criteria. This form of command filters packets based on source and destination IP address along with protocol (TCP or UDP) and port.

Use the **no** form of this command to remove an ACL specification.



Note: Configuring same filter again with change of sequence number or change of action will result in update of sequence number or filter action.



Note: TCP flags options and range options like neq, gt, lt and range are not supported by hardware in egress direction.



Note: Both Ack and established flag in tcp have same functionality in hardware.

Command Syntax

```
<(1-268435453>|) (deny|permit) tcp (A.B.C.D/M|A.B.C.D A.B.C.D|host A.B.C.D|any) ((eq|gt|lt|neq) (<0-65535>|bgp|chargen|cmd|daytime|discard|domain|drip|echo|exec|finger|ftp|ftp-data|gopher|hostname|ident|irc|klogin|kshell|login|lpd|nntp|pim-auto-rp|pop2|pop3|smtp|ssh|sunrpc|tacacs|talk|telnet|time|uucp|whois|www)|range <0-65535> <0-65535>|)(A.B.C.D/M|A.B.C.D A.B.C.D|host A.B.C.D|any) ((eq|gt|lt|neq) (<0-65535>|bgp|chargen|cmd|daytime|discard|domain|drip|echo|exec|finger|ftp|ftp-data|gopher|hostname|ident|irc|klogin|kshell|login|lpd|nntp|pim-auto-rp|pop2|pop3|smtp|ssh|sunrpc|tacacs|talk|telnet|time|uucp|whois|www)|range <0-65535> <0-65535>|)((dscp (<0-63>|af11|af12|af13|af21|af22|af23|af31|af32|af33|af41|af42|af43|cs1|cs2|cs3|cs4|cs5|cs6|cs7|default|ef))|(precedence (<0-7>|critical|flash|flashoverride|immediate|internet|network|priority|routine))|)({ack|established|fin|psh|rst|syn|urg}|)(fragments)|(vlan <1-4094>)|(inner-vlan <1-4094>)|(log)|(sample)|(redirect-to-port IFNAME)|)
```

```
<(1-268435453>|) (deny|permit) udp (A.B.C.D/M|A.B.C.D A.B.C.D|host A.B.C.D|any) ((eq|gt|lt|neq) (<0-65535>|biff|bootpc|bootps|discard|dnsix|domain|echo|isakmp|mobile-ip|nameserver|netbios-dgm|netbios-ns|netbios-ss|non500-isakmp|ntp|pim-auto-rp|snmp|snmptrap|sunrpc|syslog|tacacs|talk|tftp|time|who|xdmcp)|range <0-65535> <0-65535>|)(A.B.C.D/M|A.B.C.D A.B.C.D|host A.B.C.D|any) ((eq|gt|lt|neq) (<0-65535>|biff|bootpc|bootps|discard|dnsix|domain|echo|isakmp|mobile-ip|nameserver|netbios-dgm|netbios-ns|netbios-ss|non500-isakmp|ntp|pim-auto-rp|snmp|snmptrap|sunrpc|syslog|tacacs|talk|tftp|time|who|xdmcp)|range <0-65535> <0-65535>|)((dscp (<0-63>|af11|af12|af13|af21|af22|af23|af31|af32|af33|af41|af42|af43|cs1|cs2|cs3|cs4|cs5|cs6|cs7|default|ef))|(precedence (<0-7>|critical|flash|flashoverride|immediate|internet|network|priority|routine))|)(fragments)|(vlan <1-4094>)|(inner-vlan <1-4094>)|(log)|(sample)|)
```

```
no <(1-268435453>|) (deny|permit) tcp (A.B.C.D/M|A.B.C.D A.B.C.D|host A.B.C.D|any) ((eq|gt|lt|neq) (<0-65535>|bgp|chargen|cmd|daytime|discard|domain|drip|echo|exec|finger|ftp|ftp-data|gopher|hostname|ident|irc|klogin|kshell|login|lpd|nntp|pim-auto-rp|pop2|pop3|smtp|ssh|sunrpc|tacacs|talk|telnet|time|uucp|whois|www)|range <0-65535> <0-65535>|)(A.B.C.D/M|A.B.C.D A.B.C.D|host A.B.C.D|any) ((eq|gt|lt|neq) (<0-65535>|bgp|chargen|cmd|daytime|discard|domain|drip|echo|exec|finger|ftp|ftp-data|gopher|hostname|ident|irc|klogin|kshell|login|lpd|nntp|pim-auto-rp|pop2|pop3|smtp|ssh|sunrpc|tacacs|talk|telnet|time|uucp|whois|www)|range <0-65535> <0-65535>|)((dscp (<0-63>|af11|af12|af13|af21|af22|af23|af31|af32|af33|af41|af42|af43|cs1|cs2|cs3|cs4|cs5|cs6|cs7|default|ef))|(precedence (<0-7>|critical|flash|flashoverride|immediate|internet|network|priority|routine))|)
```

¹User Datagram Protocol

```

({ack|established|fin|psh|rst|syn|urg|}) (fragments|) (vlan <1-4094>|) (inner-vlan <1-4094>|) (log|)
(sample|) ((redirect-to-port IFNAME)|)

no (<1-268435453>|) (deny|permit) udp (A.B.C.D/M|A.B.C.D A.B.C.D|host A.B.C.D|any) ((eq|gt|lt|neq)
(<0-65535> |biff| bootpc| bootps| discard| dnsix| domain| echo| isakmp|mobile-ip|nameserver|netbios-
dgm|netbios-ns|netbios-ss|non500-isakmp| ntp|pim-auto-
rp|snmp|snmptrap|sunrpc|syslog|tacacs|talk|tftp|time|who|xnmcp) | range <0-65535> <0-65535>|)
(A.B.C.D/M|A.B.C.D A.B.C.D|host A.B.C.D| any)
((eq|gt|lt|neq) (<0-65535> |biff| bootpc| bootps| discard| dnsix| domain|echo| isakmp|mobile-
ip|nameserver|netbios-dgm|netbios-ns|netbios-ss|non500-isakmp| ntp|pim-auto-
rp|snmp|snmptrap|sunrpc|syslog|tacacs|talk|tftp|time|who|xnmcp) | range <0-65535> <0-65535>|) ((dscp
(<0-63>| af11| af12| af13| af21| af22| af23| af31| af32| af33| af41| af42| af43| cs1| cs2| cs3| cs4|
cs5| cs6| cs7| default| ef)) | (precedence (<0-7>| critical| flash | flashoverride| immediate|
internet| network| priority| routine)) |) (fragments|) (vlan <1-4094>|) (inner-vlan <1-4094>|) (log|)
(sample|) ((redirect-to-port IFNAME)|)

```

Parameters

<1-268435453>

IPv4 ACL sequence number.

deny

Drop the packet.

permit

Accept the packet.

tcp

Transmission Control Protocol.

udp

User Datagram Protocol.

A.B.C.D/M

Source or destination IP prefix and length.

A.B.C.D A.B.C.D

Source or destination IP address and mask.

host A.B.C.D

Source or destination host IP address.

any

Any source or destination IP address.

eq

Source or destination port equal to.

gt

Source or destination port greater than.

lt

Source or destination port less than.

neq

Source or destination port not equal to.

<0-65535>

Source or destination port number.

range

Range of source or destination port numbers:

<0-65535>

Lowest value in the range.

<0-65535>

Highest value in the range.

bgp

Border Gateway Protocol.

chargen

Character generator.

cmd

Remote commands.

daytime

Daytime.

discard

Discard.

domain

Domain Name Service.

drip

Dynamic Routing Information Protocol.

echo

Echo.

exec

EXEC.

finger

Finger.

ftp

File Transfer Protocol.

ftp-data

FTP data connections.

gopher

Gopher.

hostname

NIC hostname server.

ident

Ident Protocol.

irc

Internet Relay Chat.

klogin

Kerberos login.

kshell

Kerberos shell.

login

Login.

lpd

Printer service.

nntp

Network News Transport Protocol.

pim-auto-rp

PIM Auto-RP.

pop2

Post Office Protocol v2.

pop3

Post Office Protocol v3.

smtp

Simple Mail Transport Protocol.

ssh

Secure Shell.

sunrpc

Sun Remote Procedure Call.

tacacs

TAC Access Control System.

talk

Talk.

telnet

Telnet.

time

Time.

uucp

UNIX-to-UNIX Copy Program.

whois

WHOIS/NICNAME

www

World Wide Web.

netconf-ssh

Secure Shell Network Configuration

netconf-tls

Transport Layer Security Network Configuration

nntp

Range of source or destination port numbers:

dscp

Match packets with given DSCP value.

<0-63>

Enter DSCP value between 0-63.

af11

AF11 DSCP (001010) decimal value 10.

af12

AF12 DSCP (001100) decimal value 12.

af13

AF13 DSCP (001110) decimal value 14.

- af21**
AF21 DSCP (010010) decimal value 18.
- af22**
AF22 DSCP (010100) decimal value 20.
- af23**
AF23 DSCP (010110) decimal value 22.
- af31**
AF31 DSCP (011010) decimal value 26.
- af32**
AF32 DSCP (011100) decimal value 28.
- af33**
AF33 DSCP (011110) decimal value 30.
- af41**
AF41 DSCP (100010) decimal value 34.
- af42**
AF42 DSCP (100100) decimal value 36.
- af43**
AF43 DSCP (100110) decimal value 38.
- cs1**
CS1 (precedence 1) DSCP (001000) decimal value 8.
- cs2**
CS2 (precedence 2) DSCP (010000) decimal value 16.
- cs3**
CS3 (precedence 3) DSCP (011000) decimal value 24.
- cs4**
CS4 (precedence 4) DSCP (100000) decimal value 32.
- cs5**
CS5 (precedence 5) DSCP (101000) decimal value 40.
- cs6**
CS6 (precedence 6) DSCP (110000) decimal value 48.
- cs7**
CS7 (precedence 7) DSCP (111000) decimal value 56.
- default**
Default DSCP (000000) decimal value 0.
- ef**
EF DSCP (101110) decimal value 46.
- precedence**
Match packets with given precedence value.
- <0-7>**
Enter precedence value 0-7.
- critical**
Match packets with critical precedence (5).
- flash**
Match packets with flash precedence (3).

flashoverride

Match packets with flash override precedence (4).

immediate

Match packets with immediate precedence (2).

internet

Match packets with internetwork control precedence (6).

network

Match packets with network control precedence (7).

priority

Match packets with priority precedence (1).

routine

Match packets with routine precedence (0).

ack

Match on the Acknowledgment (ack) bit.

established

Matches only packets that belong to an established TCP connection.

fin

Match on the Finish (fin) bit.

psh

Match on the Push (psh) bit.

rst

Match on the Reset (rst) bit.

syn

Match on the Synchronize (syn) bit.

urg

Match on the Urgent (urg) bit.

biff

Biff.

bootpc

Bootstrap Protocol (BOOTP) client.

bootps

Bootstrap Protocol (BOOTP) server.

discard

Discard.

dnsix

DNSIX security protocol auditing.

domain

Domain Name Service.

echo

Echo.

isakmp

Internet Security Association and Key Management Protocol.

mobile-ip

Mobile IP registration.

nameserver

IEN116 name service.

netbios-dgm

Net BIOS datagram service.

netbios-ns

Net BIOS name service.

netbios-ss

Net BIOS session service.

non500-isakmp

Non500-Internet Security Association and Key Management Protocol.

ntp

Network Time Protocol.

pim-auto-rp

PIM Auto-RP.

snmp

Simple Network Management Protocol.

snmptrap

SNMP Traps.

sunrpc

Sun Remote Procedure Call.

syslog

System Logger.

tacacs

TAC Access Control System.

talk

Talk.

tftp

Trivial File Transfer Protocol.

time

Time.

who

Who service.

xdmcp

X Display Manager Control Protocol.

fragments

Check non-initial fragments.

vlan

Match packets with given vlan value.

<1-4094>

VLAN identifier.

inner-vlan

Match packets with given inner VLAN Identifier.

<1-4094>

VLAN identifier.

Default

None

Command Mode

IP access-list mode

Applicability

This command was introduced before OcNOS version 1.3.

Examples

```
#configure terminal
(config)#ip access-list ip-acl-02
(config-ip-acl)#deny udp any any eq tftp
(config-ip-acl)#deny tcp any any eq ssh
(config-ip-acl)#end
```

ipv6 access-group

Use this command to attach an IPv6 access list to an interface to filter incoming IPv6 packets.

When you attach an access list to a VLAN interface or **LAG**¹ interface as well as to a physical interface that is a member of that LAG and/or VLAN interface, the priority order is:

1. VLAN interface
2. LAG interface
3. Physical interface

For example, if you attach access lists to both a LAG interface and a physical interface that is a member of that LAG, matching traffic rules are applied to the LAG interface, but not to the physical interface.

The **time-range** parameter is optional. If used, the access-group is tied to the timer specified.

After the access-group has been configured with the time-range, to detach the access-group from the time-range, use the **no** form of this command with a time-range parameter as shown in the syntax and examples below.

To delete the access-group, use the **no** form of this command without a time-range.



Note: To attach IPv6 ACL in the ingress direction ingress-ipv6 TCAM group needs to be enabled. See the [hardware-profile filter \(XGS\) \(page 1704\)](#) command for more details.

Command Syntax

```
ipv6 access-group NAME in (time-range TR_NAME|)
no ipv6 access-group NAME in (time-range TR_NAME|)
```

Parameters

NAME

Access list name.

TR_NAME

Time range name set with the [time-range \(page 1691\)](#) command.

Default

None

Command Mode

Interface mode

Applicability

This command was introduced before OcNOS version 1.3. The **time-range** parameter was added in OcNOS version 5.0.

¹Link Aggregation Group

Examples

```
#configure terminal
(config)#ipv6 access-list mylist
(config-ipv6-acl)#permit ipv6 any any
(config-ipv6-acl)#exit
(config)#hardware-profile filter ingress-ipv6 enable

(config)#interface xe3
(config-if)#ipv6 access-group mylist in

(config)#interface xe3
(config-if)#no ipv6 access-group mylist in

(config)#interface xe3
(config-if)#ipv6 access-group mylist in time-range TIMER1

(config)#interface xe3
(config-if)#no ipv6 access-group mylist in time-range TIMER1
```

ipv6 access-list

Use this command to define a IPv6 access control list (ACL) that determines whether to accept or drop an incoming IPv6 packet based on specifications configured under the ACL. An ACL is made up of one or more ACL specifications.

Each packet that arrives at the device is compared to each specification in each ACL in the order that they are defined. The device continues to look until it has a match. If no match is found and the device reaches the end of the list, the packet is denied by default. For this reason, place the most frequently occurring specifications at the top of the list.

The device stops checking the specifications after a match occurs.

There is an implied deny specification for traffic that is not permitted. Implied specification can be updated to permit if the use-case is to deny a certain set of traffic.

IPv6 routing protocols need neighbor discovery to establish sessions. Applying IPv6 ACLs implicitly drops all the ICMPv6 packets, thereby affecting the protocol sessions. To overcome this problem, an implicit ICMPv6 permit rule is added to the IPv6 ACLs.

If required behavior is to deny the icmpv6, the implicit rule can be deleted. For example, create an IPv6 ACL:

For example,

To create an ipv6 ACL, execute the following:

```
(config)#ipv6 access-list ipv6-acl

#show ipv6 access-lists
IPv6 access list ip1
268435453 permit icmpv6 any any
```

To delete this rule execute the following:

```
(config)#ipv6 access-list ipv6-acl

(config-ipv6-acl)#no 268435453 permit icmpv6 any any

#show ipv6 access-lists
IPv6 access list ip1
```

Use the **no** form of this command to remove the ACL.

Command Syntax

```
ipv6 access-list NAME
no ipv6 access-list NAME
```

Parameters

NAME

Access-list name.

Default

None

Command Mode

Configure mode

Applicability

This command was introduced before OcNOS version 1.3. Implicit rule was introduced in OcNOS version 2.0

Examples

```
#configure terminal
(config)#ipv6 access-list ipv6-acl-01
(config-ipv6-acl)#exit
```

ipv6 access-list default

Use this command to modify the default rule action of IPv6 access-list. Default rule is applicable only when IPv6 access-list is attached to interface. Default rule will have the lowest priority and only the IPv6 packets not matching any of the user defined rules match default rule.

Command Syntax

```
default (deny-all|permit-all) (log|) (sample|)
```

Parameter

deny-all

Drop all packets.

permit-all

Accept all packets.

log

Log the packets matching the filter (in-direction only). sample Sample the packets matching the filter (in-direction only).

sample

Sample the packets matching the filter (in-direction only).

Default

No default value is specified

Command Mode

IPv6 access-list mode

Applicability

This command was introduced before OcNOS version 1.3.

Examples

```
#configure terminal
(config)#ip access-list ipv6-acl-01
(config-ipv6-acl)#default permit-all
```

```
(config-ipv6-acl)#default permit-all sample
```

ipv6 access-list filter

Use this command to define an access-control entry in an access control list (ACL) that determines whether to accept or drop an IPv6 packet based on the criteria specified. This form of this command filters packets based on:

- Protocol
- Source IP address
- Destination IP address
- DSCP value
- VLAN identifier

Use the **no** form of this command to remove an ACL specification. ACL specification can be removed using the sequence number as well.



Note: Configuring same filter again with change of sequence number or change of action will result in update of sequence number or filter action.



Note: For IPv6 source and destination address filters, only the network part from the address (upper 64 bits) is supported due to hardware restriction. If the address length is more than 64 bits, it cannot be applied on the interfaces but it can be used with distributed lists in control plane protocols.

Command Syntax

```
<1-268435453>|) (deny|permit) (<0-255>|ahp|any|eigrp|esp|gre|ipip6|ipcomp |ip6ip6|ospf|pim|vrrp)
(X::X:X/ M|X::X X::X|host X::X|any) (X::X/M|X::X X::X|any) (dscp (<0-
63>|af11| af12| af13| af21| af22| af23| af31|af32| af33| af41| af42| af43| cs1| cs2| cs3| cs4|
cs5|cs6| cs7| default| ef )) (flow-label<0-1048575>|) (fragments|) (vlan <1-4094>|)(inner-vlan <1-
4094>|) (log|) (sample|)((redirect-to-port IFNAME)|)
```

```
no <1-268435453>|) (deny|permit) (<0-255>|ahp|any|eigrp|esp|gre|ipip6|ipcomp |ip6ip6|ospf|pim|vrrp)
(X::X:X/ M|X::X X::X|host X::X|any) (X::X/M|X::X X::X|any) (dscp (<0-
63>|af11| af12| af13| af21| af22| af23| af31|af32| af33| af41| af42| af43| cs1| cs2| cs3| cs4|
cs5|cs6| cs7| default| ef )) (flow-label<0-1048575>|) (fragments|) (vlan <1-4094>|)(inner-vlan <1-
4094>|) (log|) (sample|)((redirect-to-port IFNAME)|)
```

```
no <1-268435453>
```

Parameters

<1-268435453>

IPv6 ACL sequence number.

deny

Drop the packet.

permit

Accept the packet.

<0-255>

IANA assigned protocol number.

- any**
Any protocol packet.
- ahp**
Authentication Header packet.
- eigrp**
Enhanced Interior Gateway Routing Protocol packet.
- esp**
Encapsulating Security Payload packet.
- gre**
Generic Routing Encapsulation packet.
- ipip6**
IPv4 over IPv6 Encapsulation packet.
- ipcomp**
IP Payload Compression Protocol packet.
- ipv6ip6**
IPv6 over IPv6 Encapsulation packet.
- ospf**
Open Shortest Path First packet.
- pim**
Protocol Independent Multicast packet
- rsvp**
Resource Reservation Protocol packet.
- vrrp**
Virtual Router Redundancy Protocol packet.
- X:X::X:X/M**
Source Address with network mask length.
- X:X::X:X X:X::X:X**
Source Address with wild card mask.
- any**
Any source address.
- X:X::X:X/M**
Destination address with network mask length.
- X:X::X:X X:X::X:X**
Destination address with wild card mask.
- any**
Any destination address
- any**
Match any destination IP address.
- dscp**
Match packets with given DSCP value.
- <0-63>**
Enter DSCP value between 0-63.
- af11**
AF11 DSCP (001010) decimal value 10.

- af12**
AF12 DSCP (001100) decimal value 12.
- af13**
AF13 DSCP (001110) decimal value 14.
- af21**
AF21 DSCP (010010) decimal value 18.
- af22**
AF22 DSCP (010100) decimal value 20.
- af23**
AF23 DSCP (010110) decimal value 22.
- af31**
AF31 DSCP (011010) decimal value 26.
- af32**
AF32 DSCP (011100) decimal value 28.
- af33**
AF33 DSCP (011110) decimal value 30.
- af41**
AF41 DSCP (100010) decimal value 34
- af42**
AF42 DSCP (100100) decimal value 36.
- af43**
AF43 DSCP (100110) decimal value 38.
- cs1**
CS1 (precedence 1) DSCP (001000) decimal value 8.
- cs2**
CS2 (precedence 2) DSCP (010000) decimal value 16.
- cs3**
CS3 (precedence 3) DSCP (011000) decimal value 24.
- cs4**
CS4 (precedence 4) DSCP (100000) decimal value 32.
- cs5**
CS5 (precedence 5) DSCP (101000) decimal value 40.
- cs6**
CS6 (precedence 6) DSCP (110000) decimal value 48.
- cs7**
CS7 (precedence 7) DSCP (111000) decimal value 56.
- default**
Default DSCP (000000) decimal value 0.
- ef**
EF DSCP (101110) decimal value 46.
- vlan <1-4094>**
Match packets with given VLAN identifier.
- inner-vlan <1-4094>**
Match packets with given inner Inner-VLAN identifier..

log

Log the packets matching the filter (in-direction only). sample Sample the packets matching the filter (in-direction only).

sample

Sample the packets matching the filter (in-direction only).

redirect-to-port

Redirect the packet (in-direction only)

IFNAME

Interface name to which packet to be redirected

Default

No default value is specified

Command Mode

IPv6 access-list mode

Applicability

This command was introduced before OcNOS version 1.3.

Examples

```
#configure terminal
(config)#ipv6 access-list ipv6-acl-01
(config-ipv6-acl)#permit ipipv6 any any
(config-ipv6-acl)#end
```

ipv6 access-list fragments

Use this command to permit or deny all the IPv6 fragments.

Use the no form of this command to remove an ACL specification.



Note: Configuring same filter again with change of sequence number or change of action will result in update of sequence number or filter action.

Command Syntax

```
<1-268435453>|) fragments (deny-all|permit-all) (log|) (sample|)  
no <1-268435453>|) fragments (deny-all|permit-all) (log|) (sample|)
```

Parameters

<1-268435453>

IPv6 ACL sequence number.

fragments

Check non-initial fragments.

deny-all

Specify packets to reject.

permit-all

Specify packets to forward.

log

Log the packets matching the filter (in-direction only).

sample

Sample the packets matching the filter (in-direction only).

Command Mode

IPv6 access-list mode

Applicability

This command was introduced before OcNOS version 1.3.8

Examples

```
#configure terminal  
(config)#ipv6 access-list mylist  
(config-ipv6-acl)#fragments deny-all
```

ipv6 access-list icmpv6

Use this command to permit or deny IPv6 **ICMP**¹ packets with the given source and destination IPv6 address, DSCP value, VLAN identifier, inner VLAN identifier, fragments, and flow label.

Use the **no** form of this command to remove an ACL specification.



Note: Configuring same filter again with change of sequence number or change of action will result in update of sequence number or filter action.

Command Syntax

```
(<1-268435453>|) (deny|permit) (icmpv6) (X::X:X/M|X::X:X X::X:X|any) (X::X:X/M|X::X:X X::X:X|any) (beyond-scope| destination-unreachable| echo-reply| echo-request| header| hop-limit| mld-query| mld-reduction| mld-report| nd-na| nd-ns| next-header| no-admin| no-route| packet-too-big| parameter-option| parameter-problem| port-unreachable| reassembly-timeout| redirect| renum-command| renum-result| renum-seq-number| router-advertisement| router-renumbering| router-solicitation| time-exceeded| unreachable | (<0-255> (<0-255>|))) (dscp (<0-63>|af11| af12| af13| af21| af22| af23| af31|af32| af33| af41| af42| af43| cs1| cs2| cs3| cs4| cs5|cs6| cs7| default| ef)|) (flow-label <0-1048575>|) (fragments|) (vlan <1-4094>|) (inner-vlan <1-4094>|) (log|) (sample|)((redirect-to-port IFNAME)|)
```

```
no (<1-268435453>|) (deny|permit) (icmpv6) (X::X:X/M|X::X:X X::X:X|any) (X::X:X/M|X::X:X X::X:X|any) (beyond-scope| destination-unreachable| echo-reply| echo-request| header| hop-limit| mld-query| mld-reduction| mld-report| nd-na| nd-ns| next-header| no-admin| no-route| packet-too-big| parameter-option| parameter-problem| port-unreachable| reassembly-timeout| redirect| renum-command| renum-result| renum-seq-number| router-advertisement| router-renumbering| router-solicitation| time-exceeded| unreachable | (<0-255> (<0-255>|))) (dscp (<0-63>|af11| af12| af13| af21| af22| af23| af31|af32| af33| af41| af42| af43| cs1| cs2| cs3| cs4| cs5|cs6| cs7| default| ef)|) (flow-label <0-1048575>|) (fragments|) (vlan <1-4094>|) (inner-vlan <1-4094>|) (log|) (sample|)((redirect-to-port IFNAME)|)
```

Parameters

<1-268435453>

IPv6 ACL sequence number.

deny

Drop the packet.

permit

Accept the packet.

icmpv6

Internet Control Message Protocol packet.

X::X:X/M

Source Address with network mask length.

X::X:X X::X:X

Source Address with wild card mask.

any

Any source address.

X::X:X/M

Destination address with network mask length.

¹Internet Control Message Protocol (ICMP) is a fundamental protocol used in networking to relay error messages and operational information.

X:X::X:X X:X::X:X

Destination address with wild card mask.

any

Any destination address

beyond-scope

Destination beyond scope

destination-unreachable

Destination address is unreachable

echo-reply

Echo reply

echo-request

Echo request (ping)

header

Parameter header problems

hop-limit

Hop limit exceeded in transit

mld-query

Multicast Listener Discovery Query

mld-reduction

Multicast Listener Discovery Reduction

mld-report

Multicast Listener Discovery Report

nd-na

Neighbor discovery neighbor advertisements

nd-ns

Neighbor discovery neighbor solicitations

next-header

Parameter next header problems

no-admin

Administration prohibited destination

no-route

No route to destination

packet-too-big

Packet too big

parameter-option

Parameter option problems

parameter-problem

All parameter problems

port-unreachable

Port unreachable

reassemble-timeout

Reassembly timeout

redirect

Neighbor redirect

renum-command

Router renumbering command

renum-result

Router renumbering result

renum-seq-number

Router renumbering sequence number reset

router-advertisement

Neighbor discovery router advertisements

router-renumbering

All router renumbering

router-solicitation

Neighbor discovery router solicitations

time-exceeded

All time exceeded messages

unreachable

All unreachable

<0-255>

ICMPv6 message type

<0-255>

ICMPv6 message code

dscp

Match packets with given DSCP value.

<0-63>

Enter DSCP value between 0-63.

af11

AF11 DSCP (001010) decimal value 10.

af12

AF12 DSCP (001100) decimal value 12.

af13

AF13 DSCP (001110) decimal value 14.

af21

AF21 DSCP (010010) decimal value 18.

af22

AF22 DSCP (010100) decimal value 20.

af23

AF23 DSCP (010110) decimal value 22.

af31

AF31 DSCP (011010) decimal value 26.

af32

AF32 DSCP (011100) decimal value 28.

af33

AF33 DSCP (011110) decimal value 30.

af41

AF41 DSCP (100010) decimal value 34

af42

AF42 DSCP (100100) decimal value 36.

af43

AF43 DSCP (100110) decimal value 38.

cs1

CS1 (precedence 1) DSCP (001000) decimal value 8.

cs2

CS2 (precedence 2) DSCP (010000) decimal value 16.

cs3

CS3 (precedence 3) DSCP (011000) decimal value 24.

cs4

CS4 (precedence 4) DSCP (100000) decimal value 32.

cs5

CS5 (precedence 5) DSCP (101000) decimal value 40.

cs6

CS6 (precedence 6) DSCP (110000) decimal value 48.

cs7

CS7 (precedence 7) DSCP (111000) decimal value 56.

default

Default DSCP (000000) decimal value 0.

ef

EF DSCP (101110) decimal value 46.

flow-label

IPv6 Flow-label.

<0-1048575>

IPv6 Flow-label value.

fragments

Check non-initial fragments.

vlan <1-4094>

Match packets with given VLAN identifier.

inner-vlan <1-4094>

Match packets with given inner VLAN identifier.

redirect-to-port

Redirect the packet (in-direction only)

IFNAME

Interface name to which packet to be redirected (switchport only)

log

Log the packets matching the filter (in-direction only). sample Sample the packets matching the filter (in-direction only).

sample

Sample the packets matching the filter (in-direction only).

Default

No default value is specified

Command Mode

IPv6 access-list mode

Applicability

This command was introduced before OcNOS version 1.3.

Examples

```
#configure terminal
(config)#ipv6 access-list mylist
(config-ipv6-acl)#200 permit icmpv6 any any
```

```
(config-ipv6-acl)#200 permit icmpv6 any any fragments
```

ipv6 access-list remark

Use this command to add a description to an IPv6 access control list (ACL).

Use the `no` form of this command to remove an access control list description.

Command Syntax

```
remark LINE
no remark
```

Command Syntax

LINE

ACL description up to 100 characters.

Default

No default value is specified

Command Mode

IPv6 access-list mode

Applicability

This command was introduced before OcNOS version 1.3.

Examples

```
#configure terminal
(config)#ipv6 access-list mylist
(config-ipv6-acl)# remark Permit the inside admin address
```

ipv6 access-list resequence

Use this command to modify the sequence numbers of an IPv6 access list specification.



Note: Use a non-overlapping sequence space for new sequence number sets to avoid possible unexpected rule matches during transition.



Note: Re-sequencing an ACL attached to a management interface clears the ACL counters associated to it.

Command Syntax

```
resequence <1-268435453> INCREMENT
```

Parameter

<1-268435453>

Starting Sequence number.

INCREMENT

Sequence number increment steps.

Default

No default value is specified

Command Mode

IPv6 access-list mode

Applicability

This command was introduced before OcNOS version 1.3.

Examples

```
#configure terminal
(config)#ipv6 access-list mylist
(config-ipv6-acl)#resequence 15 15
```

ipv6 access-list sctp

Use this command to allow ACL to permit or deny SCTP packets based on the given source and destination IPV6 address. Even DSCP, VLAN identifier, inner VLAN identifier, flow label, fragment, and vlan ID can be configured to permit or deny with the given values.

Use the **no** form of this command to remove an ACL specification.



Note: Configuring same filter again with change of sequence number or change of action will result in update of sequence number or filter action.

Command Syntax

```
(<1-268435453>|) (deny|permit) (sctp) (X::X:X/M|X::X:X X::X:X|any) (X::X:X/M|X::X:X
X::X:X|any) {(eq|gt|lt|neq) (<0-65535>) | (range <0-65535> <0-65535>)| (fragments)| }
(dscp (<0-63>| af11| af12| af13| af21| af22| af23| af31| af32| af33| af41| af42| af43| cs1| cs2| cs3|
cs4| cs5| cs6| cs7| default| ef)|) ((flow-label <0-1048575>)|) (fragments|)
(vlan <1-4094>|) (inner-vlan <1-4094>|) (log|) (sample|) ((redirect-to-port IFNAME)|)
no (<1-268435453>|) (deny|permit) (sctp) (X::X:X/M|X::X:X X::X:X|any) (X::X:X/M|X::X:X
X::X:X|any) {(eq|gt|lt|neq) (<0-65535>) | (range <0-65535> <0-65535>)| (fragments)| }
(dscp (<0-63>| af11| af12| af13| af21| af22| af23| af31| af32| af33| af41| af42| af43| cs1| cs2| cs3|
cs4| cs5| cs6| cs7| default| ef)|) ((flow-label <0-1048575>)|) (fragments|)
(vlan <1-4094>|) (inner-vlan <1-4094>|) (log|) (sample|) ((redirect-to-port IFNAME)|)
```

Parameters

<1-268435453>

IPv6 ACL sequence number.

deny

Drop the packet.

permit

Accept the packet.

sctp

Stream Control Transmission Protocol packet.

X::X:X/M

Source address with network mask length.

X::X:X

Source address with wild card mask.

X::X:X

Source address's wild card mask (ignored bits).

any

Any source address.

X::X:X/M

Destination address with network mask length.

X::X:X

Destination address with wild card mask.

X::X:X

Destination address's wild card mask (ignored bits).

any

Any destination address.

eq

Source or destination port equal to.

gt

Source or destination port greater than.

lt

Source or destination port less than.

neq

Source or destination port not equal to.

<0-65535>

Source or destination port number.

range

Range of source or destination port numbers:

<0-65535>

Lowest value in the range.

<0-65535>

Highest value in the range.

dscp

Match packets with given DSCP value.

<0-63>

Enter DSCP value between 0-63.

af11

AF11 DSCP (001010) decimal value 10.

af12

AF12 DSCP (001100) decimal value 12.

af13

AF13 DSCP (001110) decimal value 14.

af21

AF21 DSCP (010010) decimal value 18.

af22

AF22 DSCP (010100) decimal value 20.

af23

AF23 DSCP (010110) decimal value 22.

af31

AF31 DSCP (011010) decimal value 26.

af32

AF32 DSCP (011100) decimal value 28.

af33

AF33 DSCP (011110) decimal value 30.

af41

AF41 DSCP (100010) decimal value 34

af42

AF42 DSCP (100100) decimal value 36.

af43

AF43 DSCP (100110) decimal value 38.

cs1

CS1 (precedence 1) DSCP (001000) decimal value 8.

cs2

CS2 (precedence 2) DSCP (010000) decimal value 16.

cs3

CS3 (precedence 3) DSCP (011000) decimal value 24.

cs4

CS4 (precedence 4) DSCP (100000) decimal value 32.

cs5

CS5 (precedence 5) DSCP (101000) decimal value 40.

cs6

CS6 (precedence 6) DSCP (110000) decimal value 48.

cs7

CS7 (precedence 7) DSCP (111000) decimal value 56.

default

Default DSCP (000000) decimal value 0.

ef

EF DSCP (101110) decimal value 46.

vlan <1-4094>

Match packets with given VLAN identifier.

flow-label

IPv6 Flow-label.

<0-1048575>

IPv6 Flow-label value.

fragments

Check non-initial fragments.

inner-vlan

Match packets with given inner VLAN identifier.

<1-4094>

Enter inner-VLAN identifier.

log

Log the packets matching the filter (in-direction only). sample Sample the packets matching the filter (in-direction only).

sample

Sample the packets matching the filter (in-direction only).

redirect-to-port

Redirect the packet (in-direction only)

IFNAME

Interface name to which packet to be redirected (switchport only)

Default

None

Command Mode

IPv6 access-list mode

Applicability

This command was introduced before OcNOS version 1.3.

Examples

```
#configure terminal
(config)#ipv6 access-list mylist
(config-ipv6-acl)#200 permit sctp any any

(config-ipv6-acl)#200 permit sctp any any fragments
```

ipv6 access-list tcp|udp

Use this command to define a IPv6 access control list (ACL) specification that determines whether to accept or drop an incoming IPv6 packet based on the criteria that you specify. This form of this command filters packets based on source and destination IPv6 address along with protocol (TCP or **UDP**¹) and port.

Use the **no** form of this command to remove an ACL specification.



Note: Configuring same filter again with change of sequence number or change of action will result in update of sequence number or filter action.



Note: Range options such as neq, gt, lt and range are not supported by the hardware in the egress direction.

Command Syntax

```
(<1-268435453>|) (deny|permit) (tcp) (X::X:X/M|X::X:X X::X:X|any) (X::X:X/M|X::X:X
X::X:X|any) {(eq|gt|lt|neq) (<0-65535>|bgp|chargen|cmd|daytime|
discard|domain|drip|echo|exec|finger|ftp|ftp-
data|gopher|hostname|ident|irc|klogin|kshell|login|lpd|nntp|pim-auto-
rp|pop2|pop3|smtp|ssh|sunrpc|tacacs|talk|telnet|time|uucp|whois|www)|
(range <0-65535> <0-65535>)| (fragments) |} ((dscp (<0-63>| af11| af12| af13| af21| af22| af23|
af31| af32| af33| af41| af42| af43| cs1| cs2| cs3| cs4| cs5| cs6| cs7| default| ef ))|) (flow-label
<0-1048575>|) ({ack|established|fin|psh|rst|syn|urg|}) (vlan <1-4094>|) (inner-vlan <1-4094>|)
(log|) (sample|)
```

```
(<1-268435453>|) (deny|permit) (tcp) (X::X:X/M|X::X:X X::X:X|any) {(eq|gt|lt|neq) (<0-
65535>|bgp|chargen|cmd|daytime|discard|domain|drip| echo|exec|finger|ftp|ftp-
data|gopher|hostname|ident|irc|klogin|kshell| login|lpd|nntp|pim-auto-
rp|pop2|pop3|smtp|ssh|sunrpc|tacacs| talk|telnet|time|uucp|whois|www) |
(range <0-65535> <0-65535>)} (X::X:X/M|X::X:X X::X:X|any) {(eq|gt|lt|neq) (<0-
65535>|bgp|chargen|cmd|daytime|discard|domain| drip|echo|exec|finger|ftp|ftp-
data|gopher|hostname|ident|irc|klogin|kshell| login|lpd|nntp|pim-auto-
rp|pop2|pop3|smtp|ssh|sunrpc|tacacs| talk|telnet|time|uucp|whois|www) |
(range <0-65535> <0-65535>)|} ((dscp (<0-63>| af11| af12| af13| af21| af22| af23| af31| af32| af33|
af41| af42| af43| cs1| cs2| cs3| cs4| cs5| cs6| cs7| default| ef ))|) (flow-label <0-1048575>|)
({ack|established|fin|psh|rst|syn|urg|}) (vlan <1-4094>|) (inner-vlan <1-4094>|) (log|) (sample|)
((redirect-to-port IFNAME)|)
```

```
(<1-268435453>|) (deny|permit) (udp) (X::X:X/M|X::X:X X::X:X|any) (X::X:X/M|X::X:X
X::X:X|any) {(eq|gt|lt|neq) (<0-65535>|biff|bootpc|bootps|discard|dnsix|domain|echo|isakmp|mobile-
ip|nameserver|netbios-dgm|netbios-ns|netbios-ss|non500-isakmp|ntp|pim-auto-
rp|snmp|snmptrap|sunrpc|syslog| tacacs|talk|tftp|time|who|xdmcp) |
(range <0-65535> <0-65535>) | (fragments) |} ((dscp (<0-63>| af11| af12| af13| af21| af22| af23|
af31| af32| af33| af41| af42| af43| cs1| cs2| cs3| cs4| cs5| cs6| cs7| default| ef ))|) (flow-label
<0-1048575>|) (vlan <1-4094>|) (inner-vlan <1-4094>|) (log|) (sample|) ((redirect-to-port IFNAME)|)
```

```
(<1-268435453>|) (deny|permit) (udp) (X::X:X/M|X::X:X X::X:X|any) {(eq|gt|lt|neq) (<0-
65535>|biff|bootpc|bootps|discard|dnsix|domain|echo|isakmp|mobile-ip|nameserver|netbios-dgm|netbios-
ns|netbios-ss|non500-isakmp|ntp|pim-auto-rp|snmp|snmptrap|sunrpc|syslog|
tacacs|talk|tftp|time|who|xdmcp) |
(range <0-65535> <0-65535>) } (X::X:X/M|X::X:X X::X:X|any) {(eq|gt|lt|neq) (<0-
65535>|biff|bootpc|bootps|discard| dnsix|domain|echo|isakmp|mobile-ip|nameserver|netbios-dgm|netbios-
ns|netbios-ss|non500-isakmp|ntp|pim-auto-rp|snmp|snmptrap|sunrpc|
syslog|tacacs|talk|tftp|time|who|xdmcp) |
(range <0-65535> <0-65535>) } ((dscp (<0-63>| af11| af12| af13| af21| af22| af23| af31| af32| af33|
af41| af42| af43| cs1| cs2| cs3| cs4| cs5| cs6| cs7| default| ef ))|) (flow-label <0-1048575>|) (vlan
```

¹User Datagram Protocol

```

<1-4094>|) (inner-vlan <1-4094>|) (log|) (sample|) ((redirect-to-port IFNAME)|)

no (<1-268435453>|) (deny|permit) (tcp) (X:X::X:X/M|X:X::X:X X:X::X:X|any) (X:X::X:X/M|X:X::X:X
X:X::X:X|any) {(eq|gt|lt|neq) (<0-65535>|bgp|chargen|cmd|
daytime|discard|domain|drip|echo|exec|finger|ftp |ftp-data|gopher|hostname
|ident|irc|klogin|kshell|login|lpd|nntp|pim-auto-rp|pop2|pop3|smtp|ssh|sunrpc
|tacacs|talk|telnet|time|uucp|whois|www) |
(range <0-65535> <0-65535>|) (fragments) |} ((dscp (<0-63>| af11| af12| af13| af21| af22| af23|
af31| af32| af33| af41| af42| af43| cs1| cs2| cs3| cs4| cs5| cs6| cs7| default| ef ))|) (flow-label
<0-1048575>|) ({ack|established|fin|psh|rst|syn|urg}|)) (vlan <1-4094>|) (inner-vlan <1-4094>|)
(log|) (sample|)

no (<1-268435453>|) (deny|permit) (tcp) (X:X::X:X/M|X:X::X:X X:X::X:X|any) {(eq|gt|lt|neq) (<0-
65535>|bgp|chargen|cmd|daytime|discard|domain|drip |echo|exec|finger|ftp |ftp-
data|gopher|hostname|ident|irc|klogin|kshell |login|lpd|nntp|pim-auto-
rp|pop2|pop3|smtp|ssh|sunrpc|tacacs|talk|telnet |time|uucp|whois|www) |
(range <0-65535> <0-65535>)} (X:X::X:X/M|X:X::X:X X:X::X:X|any) {(eq|gt|lt|neq) (<0-
65535>|bgp|chargen|cmd|daytime|discard| domain|drip|echo|exec|finger|ftp |ftp-
data|gopher|hostname|ident|irc|klogin| kshell|login|lpd|nntp|pim-auto-
rp|pop2|pop3|smtp|ssh|sunrpc|tacacs|talk |telnet|time|uucp|whois|www) |
(range <0-65535> <0-65535>|) ((dscp (<0-63>| af11| af12| af13| af21| af22| af23| af31| af32| af33|
af41| af42| af43| cs1| cs2| cs3| cs4| cs5| cs6| cs7| default| ef ))|) (flow-label <0-1048575>|)
({ack|established|fin|psh|rst|syn|urg}|)) (vlan <1-4094>|) (inner-vlan <1-4094>|) (log|) (sample|)
((redirect-to-port IFNAME)|)

no (<1-268435453>|) (deny|permit) (udp) (X:X::X:X/M|X:X::X:X X:X::X:X|any) (X:X::X:X/M|X:X::X:X
X:X::X:X|any) {(eq|gt|lt|neq) (<0-65535>|biff|bootpc|bootps|discard|dnsix|domain|echo|isakmp|mobile-
ip|nameserver|netbios-dgm|netbios-ns|netbios-ss|non500-isakmp|ntp|pim-auto-
rp|snmp|snmptrap|sunrpc|syslog|tacacs|talk|tftp|time|who|xdmcp) |
(range <0-65535> <0-65535>|) (fragments) |} ((dscp (<0-63>| af11| af12| af13| af21| af22| af23|
af31| af32| af33| af41| af42| af43| cs1| cs2| cs3| cs4| cs5| cs6| cs7| default| ef ))|) (flow-label
<0-1048575>|) (vlan <1-4094>|) (inner-vlan <1-4094>|) (log|) (sample|) ((redirect-to-port IFNAME)|)

no (<1-268435453>|) (deny|permit) (udp) (X:X::X:X/M|X:X::X:X X:X::X:X|any) {(eq|gt|lt|neq) (<0-
65535>|biff|bootpc|bootps|discard|dnsix|domain|echo|isakmp|mobile-ip|nameserver|netbios-dgm|netbios-
ns|netbios-ss|non500-isakmp|ntp|pim-auto-
rp|snmp|snmptrap|sunrpc|syslog|tacacs|talk|tftp|time|who|xdmcp) |
(range <0-65535> <0-65535>)} (X:X::X:X/M|X:X::X:X X:X::X:X|any) {(eq|gt|lt|neq) (<0-
65535>|biff|bootpc|bootps|discard|dnsix|domain|echo|isakmp|mobile-ip|nameserver|netbios-dgm|netbios-
ns|netbios-ss|non500-isakmp|ntp|pim-auto-
rp|snmp|snmptrap|sunrpc|syslog|tacacs|talk|tftp|time|who|xdmcp) |
(range <0-65535> <0-65535>|) ((dscp (<0-63>| af11| af12| af13| af21| af22| af23| af31| af32| af33|
af41| af42| af43| cs1| cs2| cs3| cs4| cs5| cs6| cs7| default| ef ))|) (flow-label <0-1048575>|) (vlan
<1-4094>|) (inner-vlan <1-4094>|) (log|) (sample|) ((redirect-to-port IFNAME)|)

```

Parameters

<1-268435453>

IPv6 ACL sequence number.

deny

Drop the packet.

permit

Accept the packet.

tcp

Transmission Control Protocol.

udp

User Datagram Protocol.

X:X::X:X/M

Source or destination IPv6 prefix and length.

X:X::X:X X:X::X:X

Source or destination IPv6 address and mask.

host X:X::X:X

A single source or destination host IPv6 address.

any

Any source or destination IPv6 address.

eq

Source or destination port equal to.

gt

Source or destination port greater than.

lt

Source or destination port less than.

neq

Source or destination port not equal to.

<0-65535>

Source or destination port number.

range

Range of source or destination port numbers:

<0-65535>

Lowest value in the range.

<0-65535>

Highest value in the range.

ftp

File Transfer Protocol (21).

ssh

Secure Shell (22).

telnet

Telnet (23).

www

World Wide Web (HTTP 80).

tftp

Trivial File Transfer Protocol (69).

bootp

Bootstrap Protocol (BOOTP) client (67).

bgp

Border Gateway Protocol.

chargen

Character generator.

cmd

Remote commands.

daytime

Daytime.

discard

Discard.

domain

Domain Name Service.

drip
Dynamic Routing Information Protocol.

echo
Echo.

exec
EXEC.

finger
Finger.

ftp
File Transfer Protocol.

ftp-data
FTP data connections.

gopher
Gopher.

hostname
NIC hostname server.

ident
Ident Protocol.

irc
Internet Relay Chat.

klogin
Kerberos login.

kshell
Kerberos shell.

login
Login.

lpd
Printer service.

nnt
Network News Transport Protocol.

pim-auto-rp
PIM Auto-RP.

pop2
Post Office Protocol v2.

pop3
Post Office Protocol v3.

smtp
Simple Mail Transport Protocol.

ssh
Secure Shell.

sunrpc
Sun Remote Procedure Call.

tacacs
TAC Access Control System.

talk

Talk.

telnet

Telnet.

time

Time.

uucp

UNIX-to-UNIX Copy Program.

whois

WHOIS/NICNAME

www

World Wide Web.

nntp

Range of source or destination port numbers:

dscp

Match packets with given DSCP value.

<0-63>

Enter DSCP value between 0-63

af11

AF11 DSCP (001010) decimal value 10.

af12

AF12 DSCP (001100) decimal value 12.

af13

AF13 DSCP (001110) decimal value 14.

af21

AF21 DSCP (010010) decimal value 18.

af22

AF22 DSCP (010100) decimal value 20.

af23

AF23 DSCP (010110) decimal value 22.

af31

AF31 DSCP (011010) decimal value 26.

af32

AF32 DSCP (011100) decimal value 28.

af33

AF33 DSCP (011110) decimal value 30.

af41

AF41 DSCP (100010) decimal value 34

af42

AF42 DSCP (100100) decimal value 36.

af43

AF43 DSCP (100110) decimal value 38.

cs1

CS1 (precedence 1) DSCP (001000) decimal value 8.

cs2

CS2 (precedence 2) DSCP (010000) decimal value 16.

cs3

CS3 (precedence 3) DSCP (011000) decimal value 24.

cs4

CS4 (precedence 4) DSCP (100000) decimal value 32.

cs5

CS5 (precedence 5) DSCP (101000) decimal value 40.

cs6

CS6 (precedence 6) DSCP (110000) decimal value 48.

cs7

CS7 (precedence 7) DSCP (111000) decimal value 56.

default

Default DSCP (000000) decimal value 0.

ef

EF DSCP (101110) decimal value 46.

EF DSCP (101110) decimal value 46.

precedence

Match packets with given precedence value.

<0-7>

Enter precedence value 0-7.

critical

Match packets with critical precedence (5).

flash

Match packets with flash precedence (3).

flashoverride

Match packets with flash override precedence (4).

immediate

Match packets with immediate precedence (2).

internet

Match packets with internetwork control precedence (6).

network

Match packets with network control precedence (7).

priority

Match packets with priority precedence (1).

routine

Match packets with routine precedence (0).

ack

Match on the Acknowledgment (ack) bit.

established

Matches only packets that belong to an established TCP connection.

fin

Match on the Finish (fin) bit.

psh

Match on the Push (psh) bit.

rst	Match on the Reset (rst) bit.
syn	Match on the Synchronize (syn) bit.
urg	Match on the Urgent (urg) bit.
biff	Biff.
bootpc	Bootstrap Protocol (BOOTP) client.
bootps	Bootstrap Protocol (BOOTP) server.
discard	Discard.
dnsix	DNSIX security protocol auditing.
domain	Domain Name Service.
echo	Echo.
isakmp	Internet Security Association and Key Management Protocol.
mobile-ip	Mobile IP registration.
nameserver	IEN116 name service.
netbios-dgm	Net BIOS datagram service.
netbios-ns	Net BIOS name service.
netbios-ss	Net BIOS session service.
non500-isakmp	Non500-Internet Security Association and Key Management Protocol.
ntp	Network Time Protocol.
pim-auto-rp	PIM Auto-RP.
rip	
snmp	Simple Network Management Protocol.
snmptrap	SNMP Traps.
sunrpc	Sun Remote Procedure Call.

syslog

System Logger.

tacacs

TAC Access Control System.

talk

Talk.

tftp

Trivial File Transfer Protocol.

time

Time.

who

Who service.

xdmcp

X Display Manager Control Protocol.

log

Log the packets matching the filter (in-direction only). sample Sample the packets matching the filter (in-direction only).

sample

Sample the packets matching the filter (in-direction only).

IPv6 Flow-label.

<0-1048575>

IPv6 Flow-label value.

fragments

Check non-initial fragments.

vlan

Match packets with given vlan value.

<1-4094>

VLAN identifier

inner-vlan

Match packets with given inner VLAN identifier.

<1-4094>

Enter inner-VLAN identifier.

redirect-to-port

Redirect the packet (in-direction only)

IFNAME

Interface name to which packet to be redirected (switchport only)

Default

None

Command Mode

IPv6 access-list mode

Applicability

This command was introduced before OcNOS version 1.3.

Examples

```
#configure terminal
(config)#ipv6 access-list mylist
(config-ipv6-acl)#deny udp any eq tftp any
(config-ipv6-acl)#deny tcp fd22:bf66:78a4:10a2::/64 fdf2:860a:746a:e49c::/64 eq ssh
```

line vty

Use this command to move or change to ALL LINE VTY mode.

Command Syntax

```
line vty
```

Parameters

NA

Command Mode

Configure mode

Applicability

This command was introduced from OcNOS version 1.3.8

Examples

The following example shows entering all line mode (note the change in the prompt).

```
#configure terminal  
(config)#line vty  
(config-all-line)#exit
```

mac access-group

Use this command to attach a MAC access list to an interface to filter incoming packets.

When you attach an access list to a VLAN interface or **LAG**¹ interface as well as to a physical interface that is a member of that LAG and/or VLAN interface, the priority order is:

1. VLAN interface
2. LAG interface
3. Physical interface

For example, if you attach access lists to both a LAG interface and a physical interface that is a member of that LAG, matching traffic rules are applied to the LAG interface, but not to the physical interface.

The **time-range** parameter is optional. If used, the access-group is tied to the timer specified.

After the access-group has been configured with the time-range, to detach the access-group from the time-range, use the **no** form of this command with a time-range parameter as shown in the syntax and examples below.

To delete the access-group, use the **no** form of this command without a time-range.



- To attach a MAC ACL in the ingress direction ingress-l2 or ingress-l2-ext TCAM group needs to be enabled and to attach a MAC ACL in the egress direction egress-l2 TCAM group needs to be enabled. See [hardware-profile filter \(XGS\) \(page 1704\)](#) command for details.
- An egress ACL is supported on physical and lag interfaces only. VLAN and inner-VLAN options in ACL rules will match incoming packet VLANs even when ACL attached at egress.



Note: An access-group on egress access-group on egress direction uses the TCAM group used by the QoS output service policy. Therefore, actions are unpredictable when conflicting matches are configured on same interface. IP Infusion Inc. recommends avoiding such a configuration. Otherwise, you need to configure the priority (in QoS) or the sequence number (in ACL) carefully to handle such cases.

Egress TCAMs do not auto-expand beyond 256 entries if any entry includes a policer action. Therefore, the total number of configurable entries in the egress direction is limited to 256.

Command Syntax

```
mac access-group NAME (in|out) (in|out) (time-range TR_NAME|)
no mac access-group NAME (in|out) (time-range TR_NAME|)
```

Parameters

NAME

Access list name.

in

Filter incoming packets.

¹Link Aggregation Group

out

Filter outgoing packets.

TR_NAME

Time range name set with the [time-range \(page 1691\)](#) command.

Default

None

Command Mode

Interface mode

Applicability

This command was introduced before OcNOS version 1.3. The **time-range** parameter was added in OcNOS version 5.0.

Examples

```
#configure terminal
(config)#mac access-list mylist
(config-mac-acl)#permit any any
(config-mac-acl)#exit

(config)#hardware-profile filter ingress-l2-ext enable

(config)#interface xe3
(config-if)#mac access-group mylist in
(config-if)#exit

(config)#interface xe3
(config-if)#mac access-group mylist in time-range TIMER1
(config-if)#exit

(config)#interface xe3
(config-if)#no mac access-group mylist in time-range TIMER1
(config-if)#exit

(config)#interface xe3
(config-if)#no mac access-group mylist in
(config-if)#exit
```

mac access-list

Use this command to define a MAC access control list (ACL) that determines whether to accept or drop an incoming packet based on specifications configured under the ACL. An ACL is made up of one or more ACL specifications.

Each packet that arrives at the device is compared to each specification in each ACL in the order that they are defined. The device continues to look until it has a match. If no match is found and the device reaches the end of the list, the packet is denied by default. For this reason, place the most frequently occurring specifications at the top of the list.

The device stops checking the specifications after a match occurs.

There is an implied deny specification for traffic that is not permitted. Implied specification can be updated to permit if the use-case is to deny a certain set of traffic.

Use the **no** form of this command to remove an ACL.

Command Syntax

```
mac access-list NAME
no mac access-list NAME
```

Parameters

NAME

Access-list name.

Default

None

Command Mode

Configure mode

Applicability

This command was introduced before OcNOS version 1.3.

Examples

```
#configure terminal
(config)#mac access-list mac-acl-01
(config-mac-acl)#exit
```

mac access-list default

Use this command to modify the default rule action of mac access-list. Default rule is applicable only when access-list is attached to interface. Default rule will have the lowest priority and only the packets not matching any of the user defined rules match default rule.

Command Syntax

```
default (deny-all|permit-all) (log|) (sample|)
```

Parameters

deny-all

Drop all packets.

permit-all

Accept all packets.

log

Log the packets matching the filter (in-direction only). sample Sample the packets matching the filter (in-direction only).

sample

Sample the packets matching the filter (in-direction only).

Default

None

Command Mode

MAC access-list mode

Applicability

This command was introduced before OcNOS version 1.3.

Examples

```
#configure terminal
(config)#mac access-list mac-acl-01
(config-mac-acl)#default permit-all
```

```
(config-mac-acl)#default permit-all sample
```

mac access-list filter

Use this command to define an access control entry (ACE) in a mac access control list (ACL) that determines whether to permit or deny packets with the given source and destination MAC, ethertype cos and VLAN identifiers.

Use the **no** form of this command to remove an ACL specification. ACL specification can be removed using the sequence number as well.



Note: Configuring same filter again with change of sequence number or change of action will result in update of sequence number or filter action.



Note: Ether type option is not supported by hardware in egress direction

Command Syntax

```
(<1-268435453>|) (deny|permit) (any | (XX-XX-XX-XX-XX- XX|XX:XX:XX:XX:XX:XX|XXXX.XXXX.XXXX) (XX-XX-XX-XX-XX- XX|XX:XX:XX:XX:XX:XX|XXXX.XXXX.XXXX) | host (XX-XX-XX-XX-XX- XX|XX:XX:XX:XX:XX:XX|XXXX.XXXX.XXXX) (any | (XX-XX-XX-XX-XX- XX|XX:XX:XX:XX:XX:XX|XXXX.XXXX.XXXX) (XX-XX-XX-XX-XX- XX|XX:XX:XX:XX:XX:XX|XXXX.XXXX.XXXX) | host (XX-XX-XX-XX-XX- XX|XX:XX:XX:XX:XX:XX|XXXX.XXXX.XXXX) (aarp|appletalk|decnet- iv|diagnostic|etype-6000|etype-8042 |ip4|ip6|lat|lavc-sca|mop-console|mop- dump|vines-echo|WORD|) (cos <0-7>|) (vlan <1-4094>|) (inner- vlan <1-4094>|) (log|) (sample|)
```

```
no (<1-268435453>|) (deny|permit) (any | (XX-XX-XX-XX-XX- XX|XX:XX:XX:XX:XX:XX|XXXX.XXXX.XXXX) (XX-XX-XX-XX-XX- XX|XX:XX:XX:XX:XX:XX|XXXX.XXXX.XXXX) | host (XX-XX-XX-XX-XX- XX|XX:XX:XX:XX:XX:XX|XXXX.XXXX.XXXX) (any | (XX-XX-XX-XX-XX- XX|XX:XX:XX:XX:XX:XX|XXXX.XXXX.XXXX) (XX-XX-XX-XX-XX- XX|XX:XX:XX:XX:XX:XX|XXXX.XXXX.XXXX) | host (XX-XX-XX-XX-XX- XX|XX:XX:XX:XX:XX:XX|XXXX.XXXX.XXXX) (aarp|appletalk|decnet- iv|diagnostic|etype-6000|etype-8042 |ip4|ip6|lat|lavc-sca|mop-console|mop- dump|vines-echo|WORD|) (cos <0-7>|) (vlan <1-4094>|) (inner- vlan <1-4094>|) (log|) (sample|)
```

```
no (<1-268435453>)
```

Parameter

deny

Drop the packet.

permit

Accept the packet.

<1-268435453>

IPv4 ACL sequence number.

any

Source/Destination any.

XX-XX-XX-XX-XX-XX

Source/Destination MAC address (Option 1).

XX:XX:XX:XX:XX:XX

Source/Destination MAC address (Option 2).

XXXX.XXXX.XXXX

Source/Destination MAC address (Option 3).

XX-XX-XX-XX-XX

Source/Destination wildcard (Option1).

XX:XX:XX:XX:XX:XX

Source/Destination wildcard (Option2).

XXXX.XXXX.XXXX

Source/Destination wildcard (Option3).

host

A single source/destination host.

aarp

Ethertype - 0x80f3.

appletalk

Ethertype - 0x809b.

decnet-iv

Ethertype - 0x6003.

diagnostic

Ethertype - 0x6005.

etype-6000

Ethertype - 0x6000.

etype-8042

Ethertype - 0x8042.

ip4

Ethertype - 0x0800.

ip6

Ethertype - 0x86dd.

lat

Ethertype - 0x6004.

lavc-sca

Ethertype - 0x6007.

mop-console

Ethertype - 0x6002.

mop-dump

Ethertype - 0x6001.

vines-echo

Ethertype - 0x0baf.

WORD

Any Ether type value.

cos <0-7>

Cos value.

vlan <1-4094>

VLAN identifier.

inner-vlan <1-4094>

Inner-VLAN identifier.

log

Log the packets matching the filter (in-direction only).

sample

Sample the packets matching the filter (in-direction only).

Default

None

Command Mode

MAC ACL mode

Applicability

This command was introduced before OcNOS version 1.3.

Examples

```
#configure terminal
(config)#mac access-list mac-acl-01
(config-mac-acl)#permit 0000.1234.1234 0000.0000.0000 any

(config-mac-acl)#permit 0000.1234.1234 0000.0000.0000 any sample
```

mac access-list remark

Use this command to add a description to an MAC access control list (ACL).

Use the `no` form of this command to remove an ACL description.

Command Syntax

```
remark LINE
no remark
```

Parameters

LINE

ACL description up to 100 characters.

Default

None

Command Mode

MAC access-list mode

Applicability

This command was introduced before OcNOS version 1.3.

Examples

```
#configure terminal
(config)#mac access-list mylist
(config-mac-acl)# remark Permit the inside admin address
```

mac access-list resequence

Use this command to modify the sequence numbers of MAC access list specifications.



- Use a non-overlapping sequence space for new sequence number sets to avoid possible unexpected rule matches during transition.
- Re-sequencing an ACL attached to a management interface clears the ACL counters associated to it.

Command Syntax

```
resequence <1-268435453> INCREMENT
```

Parameters

<1-268435453>

Starting sequence number.

INCREMENT

Sequence number increment steps.

Default

None

Command Mode

MAC access-list mode

Applicability

This command was introduced before OcNOS version 1.3.

Examples

```
#configure terminal
(config)#mac access-list mylist
(config-mac-acl)#resequence 15 15
```

show access-list log-cache

Use this command to show the ACL logging table entries

Command Syntax

```
show access-lists log-cache
```

Parameters

None

Command Mode

Privileged execution mode and Exec mode

Applicability

This command was introduced before OcNOS version 1.3

Example

```
#show access-lists log-cache
2016 Oct 26 12:08:37:xe1/1: 0000.0100.0a00 -> 0000.0100.0b00, ethertype IP (0x800), proto tcp, vlan
2, 0.0.0.0:0 -> 0.0.0.0:0 ...suppressed 11 times
2016 Oct 26 12:07:51:xe1/1: 0000.0100.0a00 -> 0000.0100.0b00, ethertype IP (0x800), proto 255, vlan
2, 0.0.0.0 -> 0.0.0.0 ...suppressed 10 times
```

show access-lists

Use this command to display access lists.

Command Syntax

```
show access-lists (NAME|) (expanded|summary|)
```

Parameters

NAME

Access-list name.

expanded

Expanded access-list.

summary

Summary of access-list.

Default

None

Command Mode

Privileged execution mode

Applicability

This command was introduced before OcNOS version 1.3.

Example

```
#show access-lists expanded
IP access list Iprule1
11 permit ip 30.0.0.1 0.0.0.255 172.124.0.2 0.0.0.255
default deny-all
MAC access list Macrule1
10 permit host 0000.1234.1234 any
default deny-all
IPv6 access list ipv6-acl-01
10 deny ahp 3ffe::/64 4ffe::/64
default deny-all

#show access-lists summary
IPV4 ACL Iprule1
statistics enabled
Total ACEs Configured: 1
Configured on interfaces:
xe3/1 - egress (Router ACL)
Active on interfaces:
xe1/3 - ingress (Router ACL)
MAC ACL Macrule1
statistics enabled
Total ACEs Configured: 0
Configured on interfaces:
Active on interfaces:
IPV6 ACL ipv6-acl-01
```

```
statistics enabled
Total ACEs Configured: 2
Configured on interfaces:
xe7/1 - ingress (Router ACL)
Active on interfaces:
```

show arp access-lists

Use this command to display ARP access lists.



Note: Broadcast ARP request packets are counted twice.

Command Syntax

```
show arp access-lists (NAME|) (expanded|summary|)
```

Parameters

NAME

ARP access-list name.

expanded

Expanded access-list.

summary

Access-list summary.

Command Mode

Privileged execution mode mode and Execution mode mode

Applicability

This command was introduced in

Example

```
#show arp access-lists
ARP access list arp1
    10 permit ip 1.1.1.0/24 mac 0000.0000.0001 FFFF.FFFF.FFF0
    20 deny ip 2.2.2.0/24 mac any
    default deny-all

#show arp access-lists summary
ARP ACL arp1
    statistics enabled
    Total ACEs Configured: 2
    Configured on interfaces:
        xe1 - ingress (Port ACL)
    Active on interfaces:
        xe1 - ingress (Port ACL)
```

show ip access-lists

Use this command to display IP access lists.

Command Syntax

```
show ip access-lists (NAME|) (expanded|summary|)
```

Parameters

NAME

Access-list name.

expanded

Expanded access-list.

summary

Access-list summary.

Default

None

Command Mode

Execution mode and Privileged execution mode

Applicability

This command was introduced before OcNOS version 1.3.

Example

```
#show ip access-lists
IP access list Iprule2
11 permit ip 30.0.0.1 0.0.0.255 172.124.0.2 0.0.0.255
12 deny ip 30.0.0.2 0.0.0.255 182.124.0.3/24
default deny-all
```

```
#show ip access-lists summary
IPV4 ACL Iprule3
statistics enabled
Total ACEs Configured: 4
Configured on interfaces:
sa1 - ingress (Port ACL)
sa3 - ingress (Router ACL)
sa8 - ingress (Port ACL)
vlan1.3 - ingress (Router ACL)
xe1/1 - ingress (Port ACL)
xe1/2 - ingress (Router ACL)
xe1/3 - ingress (Router ACL)
xe3/1 - egress (Router ACL)
Active on interfaces:
sa1 - ingress (Port ACL)
xe1/1 - ingress (Port ACL)
xe1/2 - ingress (Router ACL)
xe1/3 - ingress (Router ACL)
```

show ipv6 access-lists

Use this command to display IPv6 access lists.

Command Syntax

```
show ipv6 access-lists (NAME|) (expanded|summary|)
```

Parameters

NAME

Access-list name.

expanded

Expanded access-list.

summary

Summary of access-list.

Default

None

Command Mode

Privileged execution mode and Execution mode

Applicability

This command was introduced before OcNOS version 1.3.

Example

```
#show ipv6 access-lists
IPv6 access list ipv6-acl-01
10 deny ahp 3ffe::/64 4ffe::/64
20 permit ahp 78fe::1/48 68fe::1/48
30 permit ahp 3333::1/64 4444::1/48 fragments
40 permit ahp 5555::1/64 4444::1/48 dscp af23
default deny-all
#show ipv6 access-lists summary
IPV6 ACL ipv6-acl-01
statistics enabled
Total ACEs Configured: 4
Configured on interfaces:
sa3 - ingress (Router ACL)
vlan1.3 - ingress (Router ACL)
xe1/1 - ingress (Port ACL)
xe1/2 - ingress (Router ACL)
xe1/3 - ingress (Router ACL)
Active on interfaces:
xe1/1 - ingress (Port ACL)
xe1/2 - ingress (Router ACL)
xe1/3 - ingress (Router ACL)
```

show mac access-lists

Use this command to display MAC access lists.

Command Syntax

```
show mac access-lists (NAME|) (expanded|summary|)
```

Parameters

NAME

Access-list name.

expanded

Expanded access-list.

summary

Summary of access-list.

Default

None

Command Mode

Privileged execution mode and Execution mode

Applicability

This command was introduced before OcNOS version 1.3.

Example

```
#show mac access-lists
MAC access list Macrule2
default deny-all
MAC access list Macrule3
10 permit host 0000.1234.1234 any
20 deny host 1111.1111.AAAA any 65535
30 permit host 2222.2222.AAAA any 65535
40 permit 0000.3333.3333 0000.0000.FFFF 4444.4444.4444 0000.0000.FFFF
default deny-all [match=1126931077]

# show mac access-lists summary
MAC ACL Macrule3
statistics enabled
Total ACEs Configured: 4
Configured on interfaces:
sa3 - ingress (Router ACL)
sa8 - ingress (Port ACL)
vlan1.3 - ingress (Router ACL)
xe1/1 - ingress (Port ACL)
xe1/2 - ingress (Router ACL)
xe1/3 - ingress (Router ACL)
Active on interfaces:
xe1/1 - ingress (Port ACL)
xe1/2 - ingress (Router ACL)
xe1/3 - ingress (Router ACL)
```

show running-config access-list

Use this command to show the running system status and configuration details for MAC and IP access lists.

Command Syntax

```
show running-config access-list
```

Parameters

None

Default

None

Command Mode

Privileged execution mode, Configure mode, and Route map mode

Applicability

This command was introduced before OcNOS version 1.3.

Example

```
#show running-config access-list
ip access-list abd
10 deny any any any
!
mac access-list abc
remark test
10 deny any any
!
```

show running-config aclmgr

Use this command to display the entire access list configurations along with the attachment to interfaces.

Command Syntax

```
show running-config aclmgr (all|)
```

Parameters

all

Show running config with defaults

Default

None

Command Mode

Execution mode and Privileged execution mode

Applicability

This command was introduced before OcNOS version 1.3.

Example

```
>enable
#show running-config aclmgr
ip access-list ip-acl-01
11 permit ip 30.0.0.1 0.0.0.255 172.124.0.2 0.0.0.255
12 deny ip 30.0.0.2 0.0.0.255 182.124.0.3/24
mac access-list mac-acl-01
10 permit host 0000.1234.1234 any
20 permit host 0000.1111.AAAA any ipv4 cos 3 vlan 3
!
ipv6 access-list ipv6-acl-01
10 deny ipv6 3ffe::/64 4ffe::/64 dscp af43
20 permit ipv6 78fe::/64 68fe::/64 dscp cs3
!
interface xel/1
ip access-group ip-acl-01 in
!
```

show running-config ipv6 access-list

Use this command to show the running system status and configuration details for IPv6 access lists.

Command Syntax

```
show running-config ipv6 access-list
```

Parameters

None

Default

None

Command Mode

Privileged execution mode, Configure mode, and Route map mode

Applicability

This command was introduced before OcNOS version 1.3.

Example

```
#show running-config ipv6 access-list
ipv6 access-list test
10 permit any any any
```

Access Control List Commands (Standard)

This chapter is a reference for the standard Access Control List (ACL) commands. Standard access-lists are not allowed to be attached to interfaces and are used for protocol-level filtering.

ip access-list standard	1325
ip access-list standard filter	1326
ipv6 access-list standard	1327
ipv6 access-list standard filter	1328

ip access-list standard

Use this command to define a standard IP access control list (ACL) in which multiple specifications can be configured. A specification determines whether to accept or drop an incoming IP packet based on the source IP address, either an exact match or a range of prefixes.

A standard ACL can be used by Layer 3 and SNMP protocols to permit or deny IP packets from a host or a range of prefixes.

Use the **no** form of this command to remove an ACL.



Note: Standard access-lists are not allowed to be attached to interfaces and are used for protocol-level filtering purposes.

Command Syntax

```
ip access-list standard NAME
no ip access-list standard NAME
```

Parameter

NAME

Standard IP access-list name.

Default

None

Command Mode

Configure mode

Applicability

This command was introduced in . OcNOS version 1.3.6

Examples

```
#configure terminal
(config)#ip access-list standard ip-acl-01
(config-ip-acl-std)#exit
(config)#no ip access-list standard ip-acl-01
```

ip access-list standard filter

Use this command to configure an access control entry in an access control list (ACL).

This command determines whether to accept or drop a packet based on the configured source IP address.

Use the **no** form of this command to remove an ACL specification.

Command Syntax

```
(deny|permit) (A.B.C.D/M|A.B.C.D A.B.C.D|host A.B.C.D|any)
no (deny|permit) (A.B.C.D/M|A.B.C.D A.B.C.D|host A.B.C.D|any)
```

Parameter

deny

Drop the packet.

permit

Accept the packet.

A.B.C.D/M

Source IP prefix and length.

A.B.C.D A.B.C.D

Source IP address and mask.

host A.B.C.D

A single source host IP address.

any

Match any source IP address.

Default

None

Command Mode

Standard IP access-list mode

Applicability

This command was introduced in OcNOS version 1.3.6 .

Examples

```
#configure terminal
(config)#ip access-list ip-acl-01
(config-ip-acl-std)#permit 30.30.30.0/24
(config-ip-acl-std)#no permit 30.30.30.0/24
```

Ipv6 access-list standard

Use this command to define a standard IPv6 access control list (ACL) in which multiple specifications can be configured. A specification determines whether to accept or drop an incoming IPv6 packet based on the source IPv6 address, either an exact match or a range of prefixes.

A standard IPv6 ACL can be used by Layer 3 protocols to permit or deny IPv6 packets from a host or a range of prefixes.

Use the **no** form of this command to remove an ACL.



Note: Standard access-lists are not allowed to be attached to interfaces and are used for protocol-level filtering purposes.

Command Syntax

```
ipv6 access-list standard NAME
no ipv6 access-list standard NAME
```

Parameter

NAME

Standard IPv6 access-list name.

Default

None

Command Mode

Configure mode

Applicability

This command was introduced in . OcNOS version 1.3.6

Examples

```
#configure terminal
(config)#ipv6 access-list standard ipv6-acl-01
(config-ipv6-acl-std)#exit
(config)#no ipv6 access-list standard ipv6-acl-01
```

ipv6 access-list standard filter

Use this command to configure access control entry in an access control list (ACL). This command determines whether to accept or drop a packet based on the configured IPv6 prefix.

Use the **no** form of this command to remove an ACL specification.

Command Syntax

```
(deny|permit) (X:X::X:X/M|X:X::X:X X:X::X:X|any)
no (deny|permit) (X:X::X:X/M|X:X::X:X X:X::X:X|any)
```

Parameters

deny

Drop the packet.

permit

Accept the packet.

X:X::X:X/M

Source address with network mask length.

X:X::X:X X:X::X:X

Source address with wild card mask.

any

Any source address.

Default

None

Command Mode

Standard IPv6 access-list mode

Applicability

This command was introduced in . OcNOS version 1.3.6

Examples

```
#configure terminal
(config)#ipv6 access-list standard ipv6-acl-01
(config-ipv6-acl-std)#permit 2000::0/64
(config-ipv6-acl-std)#no permit 2000::0/64
```

DHCP Snooping Commands

This chapter describes the commands for **DHCP**¹ snooping.

debug ip dhcp snooping	1330
ip dhcp snooping arp-inspection validate	1331
ip dhcp snooping binding bridge	1333
ip dhcp snooping database	1335
renew ip dhcp snooping binding database	1336
show debugging ip dhcp snooping	1337
show ip dhcp snooping arp-inspection statistics bridge	1338
show ip dhcp snooping bridge	1339
show ip dhcp snooping binding bridge	1341

¹Dynamic Host Configuration Protocol

debug ip dhcp snooping

Use this command to enable the debugging **DHCP**¹ snooping.

Use the **no** parameter to disable the debug options.

Command Syntax

```
debug ip dhcp snooping (event|rx|tx|packet|all)
no debug ip dhcp snooping (event|rx|tx|packet|all)
```

Parameters

event

Enable event debugging

rx

Enable receive debugging

tx

Enable transmit debugging

packet

Enable packet debugging

all

Enable all debugging

Default

By default all debugging options are disabled.

Command Mode

Exec mode and configure mode

Applicability

This command was introduced in OcNOS version 5.0.

Example

```
#debug ip dhcp snooping all
#no debug ip dhcp snooping packet
```

¹Dynamic Host Configuration Protocol

ip dhcp snooping arp-inspection validate

Use this command to enable validation of the source-mac, destination-mac, or IP address field in the ARP packet payload.



Note: The IP address in a payload is validated for not being a broadcast address, a reserved zero IP address, and multicast address.

Use the **no** form of this command to disable validation of the source-mac, destination-mac, or IP address field in the ARP packet payload

Command Syntax

```
ip dhcp snooping arp-inspection validate (dst-mac | ip | src-mac) bridge <1-32>  
no ip dhcp snooping arp-inspection validate (dst-mac | ip | src-mac) bridge <1-32>
```

Parameters

dst-mac

Destination MAC validation

ip

ARP IP address validation

src-mac

Source MAC validation

<1-32>

Bridge number

Default

None

Command Mode

Configure mode

Applicability

This command was introduced in OcNOS version 5.0.

Examples

```
configure terminal  
(config)# bridge 1 protocol mstp  
(config)#ip dhcp snooping bridge 1  
(config)#ip dhcp snooping arp-inspection bridge 1  
(config)#ip dhcp snooping arp-inspection validate dst-mac bridge 1  
(config)#no ip dhcp snooping arp-inspection validate dst-mac bridge 1  
(config)#ip dhcp snooping arp-inspection validate src-mac bridge 1
```

```
(config)#no ip dhcp snooping arp-inspection validate src-mac bridge 1
(config)#ip dhcp snooping arp-inspection validate ip bridge 1
(config)#no ip dhcp snooping arp-inspection validate ip bridge 1
```

ip dhcp snooping binding bridge

Use this command to create a static **DHCP**¹ snooping entry.

Use the no form of this command to delete the snoop entry created.

Command Syntax

```
ip dhcp snooping binding bridge <1-32> <XXXX.XXXX.XXXX> <1-4094> < ipv4> < A.B.C.D> <IFNAME>
no ip dhcp snooping binding bridge <1-32> <XXXX.XXXX.XXXX> <1-4094> < ipv4>
ip dhcp snooping binding bridge <1-32> <XXXX.XXXX.XXXX> <1-4094> < ipv6> < X:X::X:X > <IFNAME>
no ip dhcp snooping binding bridge <1-32> <XXXX.XXXX.XXXX> <1-4094> < ipv6>
```

Parameters

<1-32>

Bridge number

XXXX.XXXX.XXXX

MAC address in HHHH.HHHH.HHHH format

<1-4094>

VLAN ID

ipv4

IPv4 protocol

ipv6

IPv6 protocol

A.B.C.D

IPv4 address type

X:X::X:X

IPv6 Address

Default

None

Command Mode

Configure mode

Applicability

This command is introduced in OcNOS version 5.0.

Example

```
OcNOS(config)#ip dhcp snooping binding bridge 1 0000.0000.0001 10 ipv4 10.1.1.1 cel
```

¹Dynamic Host Configuration Protocol

```
OcNOS(config)#comm
OcNOS(config)#ip dhcp snooping binding bridge 1 0000.0000.0002 10 ipv6 1000::2 cel
OcNOS(config)#comm
OcNOS(config)#end
OcNOS#show ip dhcp snooping binding bridge 1
Total number of static IPV4 entries      : 1
Total number of dynamic IPV4 entries     : 0
Total number of static IPV6 entries      : 1
Total number of dynamic IPV6 entries     : 0
-----
MacAddress      IPAddress      Lease(sec)  Type           VLAN  Interface
-----
0000.0000.0001  10.1.1.1      0           static         10    cel
0000.0000.0002  1000::2       0           static         10    cel
OcNOS#
OcNOS(config)#no ip dhcp snooping binding bridge 1 0000.0000.0001 10 ipv4
```

ip dhcp snooping database

Use this command to write the entries in the binding table to persistent storage.

Command Syntax

```
ip dhcp snooping database bridge <1-32>
```

Parameters

<1-32>

Bridge number

Default

No default value is specified.

Command Mode

Privileged Exec Mode and Exec mode

Applicability

This command was introduced in OcNOS version 5.0.

Example

```
#ip dhcp snooping database bridge 1
```

renew ip dhcp snooping binding database

Use this command to populate the binding table by fetching the binding entries from persistent storage.

Command Syntax

```
renew ip dhcp snooping (source|) binding database bridge <1-32>
```

Parameters

<1-32>

Bridge number

source

IP source guard

Default

No default value is specified.

Command Mode

Privileged Exec Mode and Exec mode

Applicability

This command was introduced in OcNOS version 5.0.

Example

```
#renew ip dhcp snooping binding database bridge 1
```

show debugging ip dhcp snooping

Use this command to display the enabled debugging options.

Command Syntax

```
show debugging ip dhcp snooping
```

Parameters

None

Command Mode

Privileged Exec Mode and Exec mode

Applicability

This command was introduced in OcNOS version 5.0.

Example

```
#show debugging ip dhcp snooping
DHCP snoop debugging status:
DHCP snoop event debugging is on
DHCP snoop tx debugging is on
```

show ip dhcp snooping arp-inspection statistics bridge

Use this command to show dhcp dynamic ARP inspection related statistics on bridge.

Command Syntax

```
show ip dhcp snooping arp-inspection statistics bridge <1-32>
```

Parameters

<1-32>

Bridge number.

Command Mode

Exec mode

Applicability

This command was introduced in OcNOS version 5.0.

Examples

```
#show ip dhcp snooping arp-inspection statistics bridge 1
bridge      forwarded  dai dropped
-----
1           9          1
```

[Table 77](#) explains the fields in the output.

Table 77. show ip dhcp snooping arp-inspection statistics bridge fields

Field	Description
bridge	Bridge number.
forwarded	Number of forwarded packets.
dai dropped	Number of dropped packets.

show ip dhcp snooping bridge

Use this command to display the **DHCP**¹ configuration, including trusted ports, configured VLAN, active VLAN, and strict validation status.

Command Syntax

```
show ip dhcp snooping bridge <1-32>
```

Parameters

<1-32>

Bridge number

Command Mode

Exec mode

Applicability

This command was introduced in OcNOS version 5.0.

Example

```
#show ip dhcp snooping bridge 1
Bridge Group                : 1
DHCP snooping is           : Enabled
DHCP snooping option82 is  : Disabled
Verification of hwaddr field is : Disabled
Strict validation of DHCP packet is : Disabled
DB Write Interval(secs)    : 300
DHCP snooping is configured on following VLANs : 20,30
DHCP snooping is operational on following VLANs : 20,30
DHCP snooping trust is configured on the following Interfaces
Interface                  Trusted
-----                  -
xe1                        Yes
DHCP snooping IP Source Guard is configured on the following Interfaces
Interface                  Source Guard
-----                  -
```

[Table 78](#) explains the fields in the output.

Table 78. show ip dhcp snooping bridge fields

Field	Description
Bridge Group	Bridge number
DHCP snooping is	Whether DHCP snooping is enabled
DHCP snooping	Whether DHCP snooping option 82 is enabled

¹Dynamic Host Configuration Protocol

Table 78. show ip dhcp snooping bridge fields (continued)

Field	Description
option82 is	
Verification of hwaddr field is	Whether verification of hwaddr field is enabled
Strict validation of DHCP packet is	Whether strict validation of DHCP packets is enabled
DB Write Interval (secs)	Database write interval in seconds
DHCP snooping is configured on following VLANs	VLANs on which DHCP snooping is enabled
DHCP snooping is operational on following VLANs	VLANs on which DHCP snooping is operating
Interface	Interface name
Trusted	Whether DHCP snooping trust is enabled on the interface
Source Guard	Whether DHCP snooping IP source guard is enabled on the interface

show ip dhcp snooping binding bridge

Use this command to display the **DHCP**¹ snooping binding table.

Command Syntax

```
show ip dhcp snooping binding bridge <1-32>
```

Parameters

<1-32>

Bridge number

Command Mode

Exec mode

Applicability

This command was introduced in OcNOS version 5.0.

Example

```
#show ip dhcp snooping binding bridge 1
Total number of static IPV4 entries           : 0
Total number of dynamic IPV4 entries         : 2
Total number of static IPV6 entries          : 0
Total number of dynamic IPV6 entries         : 0
-----
MacAddress      IpAddress      Lease(sec)  Type           VLAN  Interface
-----
3cfd.fe0b.06e0  12.12.12.10    30          dhcp-snooping  20    xe12
3cfd.fe0b.06e0  30.30.30.30    480         dhcp-snooping  30    xe12
```

[Table 79](#) explains the output .

Table 79. show ip dhcp snooping binding bridge fields

Field	Description
Total number of static IPV4 entries	Number of static IPV4 entries.
Total number of dynamic IPV4 entries	Number of dynamic IPV4 entries.
Total number of static IPV6 entries	Number of static IPV6 entries.
Total number of dynamic IPV6 entries	Number of dynamic IPV6 entries .
MacAddress	MAC address of the interface.

¹Dynamic Host Configuration Protocol

Table 79. show ip dhcp snooping binding bridge fields (continued)

Field	Description
IP Address	IP address of the peer device.
Lease (sec)	DHCP lease time in seconds provided to untrusted IP addresses.
Type	Configured either statically or dynamically by the DHCP server.
VLAN	Identifier of the number.
Interface	Interface is being snooped.

IP Source Guard Commands

This chapter describes the commands for IP Source Guard (IPSG):

hardware-profile filter ipsg	1344
hardware-profile filter ipsg-ipv6	1345
ip verify source dhcp-snooping-vlan	1346

hardware-profile filter ipsg

Use this command to enable or disable the ingress IPSG TCAM group for IPv4.

Command Syntax

```
hardware-profile filter ipsg (disable | enable)
```

Parameters

enable

Enable the ingress IPSG TCAM group.

disable

Disable the ingress IPSG TCAM group.

Default

None

Command Mode

Configure mode

Applicability

This command was introduced in OcNOS version 5.0.

Examples

```
OcNOS#configure terminal
OcNOS(config)#hardware-profile filter ipsg enable
```

hardware-profile filter ipsg-ipv6

Use this command to enable or disable the ingress IPSG TCAM group for IPv6.

Command Syntax

```
hardware-profile filter ipsg-ipv6 (disable | enable)
```

Parameters

enable

Enable the ingress IPSG TCAM group.

disable

Disable the ingress IPSG TCAM group.

Default

None

Command Mode

Configure mode

Applicability

This command was introduced in OcNOS version 5.0.

Examples

```
OcNOS#configure terminal  
OcNOS(config)#hardware-profile filter ipsg-ipv6 disable
```

ip verify source dhcp-snooping-vlan

Use this command to enable the IPSG feature at the interface level.

Use the no form of this command to disable the IPSG on an interface.

Command Syntax

```
ip verify source dhcp-snooping-vlan
no ip verify source dhcp-snooping-vlan
```

Parameters

None

Default

None

Command Mode

Interface mode

Applicability

This command was introduced in OcNOS version 5.0.

Examples

```
OcNOS#configure terminal
OcNOS(config)#interface xel
OcNOS(config-if)#ip verify source dhcp-snooping-vlan

OcNOS(config-if)#no ip verify source dhcp-snooping-vlan
```

Internet Protocol Security Commands

This chapter is a reference for the Internet Protocol Security (IPsec) commands.

crypto ipsec transform-set	1348
crypto map	1351
mode	1352
set peer	1353
set session-key	1354
set transform-set	1356
sequence	1357
show crypto ipsec transform-set	1358

crypto ipsec transform-set

Use this command to configure a transform set that defines protocols and algorithm settings to apply to IPSec protected traffic.

During the IPSec security association negotiation, the peers agree to use a particular transform-set to be used for protecting a particular data flow.

Several transform-sets can be specified and associated with a crypto map entry.

A transform set defines the IPSec security protocols: Encapsulation Security Protocol (ESP) or Authentication Header (AH), and also specifies which algorithms to use with the selected security protocol.

Command Syntax

```
crypto ipsec transform-set NAME
crypto ipsec transform-set NAME ah (none|ah-md5|ah-sha1|ah-sha256|ah-sha384|ah-sha512)
crypto ipsec transform-set NAME esp-auth (none|esp-md5|esp-sha1|esp-sha256|esp-sha384|esp-sha512)
esp-enc (esp-null|esp-3des|esp-aes|esp-aes192|esp-aes256|esp-blf|esp-blf192|esp-blf256|esp-cast)
crypto ipsec transform-set NAME mode (transport)
no crypto ipsec transform-set NAME mode
no crypto ipsec transform-set NAME
```

Parameters

NAME

Name of the transform set.

mode

Change the transform-set mode to tunnel or transport.

transport

The payload (data) of the original IP packet is protected.

ah

Authentication Header protocol provides data authentication.

none

No authentication.

ah-md5

Authentication Header with Message Digest 5 (MD5) Hashed Message Authentication Code (HMAC) variant.

ah-sha1

Authentication Header with Secure Hash Algorithm 1 (SHA-1) Hashed Message Authentication Code (HMAC) variant.

ah-sha256

Authentication Header with Secure Hash Algorithm 256 (SHA-256) Hashed Message Authentication Code (HMAC) variant.

ah-sha384

Authentication Header with Secure Hash Algorithm 384 (SHA-384) Hashed Message Authentication Code (HMAC) variant.

ah-sha512

Authentication Header with Secure Hash Algorithm 512 (SHA-512) Hashed Message Authentication Code (HMAC) variant.

esp-auth

Encapsulating Security Payload authentication protocol provides data authentication.

none

No authentication.

esp-md5

Encapsulating Security Payload with Message Digest 5 (MD5) Hashed Message Authentication Code (HMAC) variant.

esp-sha1

Encapsulating Security Payload with Secure Hash Algorithm 1 (SHA-1) Hashed Message Authentication Code (HMAC) variant.

esp-sha256

Encapsulating Security Payload with Secure Hash Algorithm 256 (SHA-256) Hashed Message Authentication Code (HMAC) variant.

esp-sha384

Encapsulating Security Payload with Secure Hash Algorithm 384 (SHA-384) Hashed Message Authentication Code (HMAC) variant.

esp-sha512

Encapsulating Security Payload with Secure Hash Algorithm 512 (SHA-512) Hashed Message Authentication Code (HMAC) variant.

esp-enc

Encapsulating Security Payload encryption protocol

esp-null

Encapsulating Security Payload null encryption.

esp-3des

Encapsulating Security Payload with 168-bit DES encryption (3DES or Triple DES).

esp-aes

Alternative AES.

esp-aes192

Alternative AES192.

esp-aes256

Alternative AES256.

esp-blf

Alternative Blowfish.

esp-blf192

Alternative Blowfish192.

esp-blf256

Alternative Blowfish256.

esp-cast

Alternative Cast (IKEv1 not supported).

Command Mode

Command mode

Applicability

This command is introduced in OcNOS version 6.0.0

Example

```
#configure terminal
(config)#crypto ipsec transform-set TEST_ESP esp-auth esp-md5 esp-enc esp-3des
(config)#crypto ipsec transform-set TEST_AH ah ah-sha512
```

crypto map

Use this command to create or change a crypto map entry and enter crypto map configuration mode.

Use the **no** form of this command to delete a crypto map entry or set.

Command Syntax

```
crypto map MAP-NAME ipsec-manual
no crypto map MAP-NAME
```

Parameters

MAP-NAME

Name of the crypto map set (maximum length 127).

ipsec-manual

Do not use IKE to establish IPSec security associations.

Command Mode

Configure mode

Applicability

This command is introduced in OcNOS version 6.0.0

Example

```
(config)#crypto map MAP1 ipsec-manual
(config-crypto)#
```

mode

Use this command to set the mode of negotiation for a transform set.

Use the `no` form of this command to reset the mode to its default (tunnel).

Command Syntax

```
mode (tunnel|transport)
no mode
```

Parameters

tunnel

The entire original IP packet is protected (default).

transport

The payload (data) of the original IP packet is protected.

Default

Tunnel mode

Command Mode

Transform Set mode

Applicability

This command is introduced in OcNOS version 6.0.0

Example

```
(config)#crypto ipsec transform-set TEST_ESP mode transport
(config-transform)#mode transport
```

set peer

Use this command to specify an IPsec peer IPv4 or IPv6 for a crypto map.

Use the `no` form of this command to remove an IPsec peer from a crypto map entry.

Command syntax

```
set peer (A.B.C.D | X:X::X:X) (spi <0-4096> |)
no set peer (A.B.C.D | X:X::X:X)
```

Parameters

A.B.C.D

IPv4 peer address

X:X:X:X

IPv6 peer address

spi

Specifies the security parameter index (SPI), a number that is used to uniquely identify a security association.

<0-4096>

Security parameter index (SPI) range

Default

None

Command Mode

Crypto Map sequence mode

Applicability

This command is introduced in OcNOS version 6.0.0

Examples

```
#configure terminal
(config)#crypto map MAP1 ipsec-manual
(config-crypto)#sequence 1
(config-crypto-seq)#set transform-set TEST_ESP
(config-crypto-seq)#set peer fe80::3617:ebff:fe0e:1222 spi 200
```

set session-key

Use this command to define IPsec keys for security associations via ipsec-manual crypto map entries.

When you define multiple IPsec session keys within a single crypto map, you can assign the same security parameter index (SPI) number to all the keys. The SPI is used to identify the security association used with the crypto map.

Session keys at one peer must match the session keys at the remote peer.

Command syntax

```
set session-key (inbound|outbound) (esp) <0-4096> cipher HEX-KEY-DATA authenticator HEX-KEY-DATA
no set session-key (inbound|outbound) esp <0-4096>
```

Parameters

inbound

Sets the inbound IPsec session key. Both inbound and outbound keys must be set.

outbound

Sets the outbound IPsec session key. Both inbound and outbound keys must be set.

esp

Sets the IPsec session key for the Encapsulation Security Protocol.

<0-4096>

Specifies the security parameter index (SPI), a number that is used to uniquely identify a security association.

cipher

Indicates that the key string is to be used with the ESP encryption.

HEX-KEY-DATA

Specifies the session key in hexadecimal format.

authenticator

Indicates that the key string is to be used with the ESP authentication.

Default

None

Command Mode

Crypto Map sequence mode

Applicability

This command is introduced in OcNOS version 6.0.0

Examples

```
#configure terminal
(config)#crypto map MAP1 ipsec-manual
(config-crypto)#sequence 1
(config-crypto-seq)#set session-key outbound esp 200 cipher
```

```
12345678123456781234567812345678123456781234567812345678 authenticator 123456781234567812345678  
(config-crypto-seq)#set session-key inbound esp 200 cipher  
12345678123456781234567812345678123456781234567812345678 authenticator 123456781234567812345678
```

set transform-set

Use this command to specify which transform sets to include in a crypto map entry.

Use no form of this command to unset the transform set.

Command syntax

```
set transform-set NAME
no set transform-set NAME
```

Parameters

NAME

Transform-set name

Default

None

Command Mode

Crypto Map sequence mode

Applicability

This command is introduced in OcNOS version 6.0.0

Examples

```
#configure terminal
(config)#crypto map MAP1 ipsec-manual
(config-crypto)#sequence 1
(config-crypto-seq)#set transform-set TEST_ESP
```

sequence

The number you assign to the seq-num will be used to rank multiple crypto map entries within a crypto map set. This number defines the priority of crypto-map evaluation within a crypto map set.

Command syntax

```
sequence <1-65535>  
no sequence <1-65535>
```

Parameters

<1-65535>

Value for crypto map sequence number.

Default

None

Command Mode

Crypto Map mode

Applicability

Introduced in OcNOS version 6.0.0

Examples

```
#configure terminal  
(config)#crypto map MAP1 ipsec-manual  
(config-crypto)#sequence 1  
(config-crypto-seq)#
```

show crypto ipsec transform-set

Use this command to show the IPsec transform-set entries.

Command syntax

```
show crypto ipsec transform-set NAME
```

Parameters

NAME

Transform-set name

Default

None

Command Mode

Execution mode and Privileged execution mode

Applicability

Introduced in OcNOS version 6.0.0

Examples

```
#show crypto ipsec transform-set TEST_ESP
Transform set t3
Mode is Transport
Algorithm none esp-3des esp-md5
```

| SYSTEM MANAGEMENT CONFIGURATION

LAG with RTAG7 Hashing	1360
Overview	1360
Topology	1360
Dynamic LAG with RTAG7	1360
Static LAG with RTAG7	1362

LAG with RTAG7 Hashing

Overview

Traffic can be load balanced within an LACP trunk group and within an ECMP in a controlled manner using the RTAG7 hashing algorithm.

Topology

Figure 75. LACP with RTAG7 Configuration

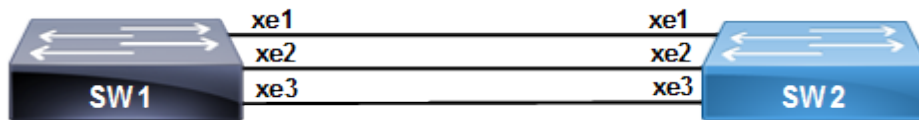

Dynamic LAG with RTAG7

SW1

#configure terminal	Enter configure mode.
(config)#bridge 1 protocol mstp	Configure bridge 1 as MSTP bridge.
(config)#vlan 2-10 bridge 1	Configure VLANS.
(config)#load-balance rtag7	Enable load-balance for rtag7 globally.
(config)#load-balance rtag7 l2 src-mac dest-mac ether-type vlan	Enabling load-balance rtag7 for l2 with all options.
(config)#load-balance rtag7 ipv4 dest-ipv4 src-ipv4 destl4-port srcl4-port protocol-id	Enabling load-balance rtag7 for ipv4 with all options.
(config)#interface po1	Enter into port channel interface po1.
(config-if)#switchport	Configure po1 as a layer 2 port.
(config-if)#bridge-group 1	Associate bridge to an interface.
(config-if)#switchport mode trunk	Configure port as a trunk.
(config-if)#switchport trunk allowed vlan all	Allow all the VLANs on the xe1 interface.
(config-if)#port-channel load-balance rtag7	Enable rtag7 load-balancing method.
(config-if)#exit	Exit the po1 interface mode.
(config)#interface xe1	Enter interface mode.
(config-if)#switchport	Configure xe1 as a layer 2 port.
(config-if)#bridge-group 1	Associate bridge to an interface.
(config-if)#switchport mode trunk	Configure port as a trunk.
(config-if)#switchport trunk allowed vlan all	Allow all the VLANs on the xe1 interface.

(config-if)#channel-group 1 mode active	Make port as part of port channel
(config-if)#exit	Exit the xe1 interface mode.
(config)#interface xe2	Enter interface mode.
(config-if)#switchport	Configure xe2 as a layer 2 port.
(config-if)#bridge-group 1	Associate bridge to an interface.
(config-if)#switchport mode trunk	Configure port as a trunk.
(config-if)#switchport trunk allowed vlan all	Allow all the VLANs on the xe2 interface.
(config-if)#channel-group 1 mode active	Make port as part of port channel..
(config-if)#exit	Exit the xe2 interface mode.
(config)#interface xe3	Enter interface mode.
(config-if)#switchport	Configure xe3 as a layer 2 port .
(config-if)#bridge-group 1	Associate bridge to an interface.
(config-if)#switchport mode trunk	Configure port as a trunk.
(config-if)#switchport trunk allowed vlan all	Allow all the VLANs on the xe3 interface.
(config-if)#channel-group 1 mode active	Make port as part of port channel.
(config-if)#exit	Exit the xe3 interface mode.

SW2

#configure terminal	Enter configure mode.
(config)#bridge 1 protocol mstp	Configure bridge 1 as MSTP bridge.
(config)#vlan 2-10 bridge 1	Configure VLANS.
(config)#interface po1	Enter interface mode
(config-if)#switchport	Configure po1 as a layer 2 port
(config-if)#bridge-group 1	Associate bridge to an interface
(config-if)#switchport mode trunk	Configure port as a trunk
(config-if)#switchport trunk allowed vlan all	
(config-if)#exit	Exit the interface mode
(config)#interface xe1	Enter interface mode.
(config-if)#switchport	Configure xe1 as a layer 2 port.
(config-if)#bridge-group 1	Associate bridge to an interface.
(config-if)#switchport mode trunk	Configure port as a trunk.
(config-if)#switchport trunk allowed vlan all	Allow all the VLANs on the xe1 interface.
(config-if)#channel-group 1 mode active	Make port as part of port channel.
(config-if)#exit	Exit the xe1 interface mode.
(config)#interface xe2	Enter interface mode.
(config-if)#switchport	Configure xe2 as a layer 2 port.

<code>(config-if)#bridge-group 1</code>	Associate bridge to an interface.
<code>(config-if)#switchport mode trunk</code>	Configure port as a trunk.
<code>(config-if)#switchport trunk allowed vlan all</code>	Allow all the VLANs on the xe2 interface.
<code>(config-if)#channel-group 1 mode active</code>	Make port as part of port channel.
<code>(config-if)#exit</code>	Exit the xe2 interface mode.
<code>(config)#interface xe3</code>	Enter interface mode.
<code>(config-if)#switchport</code>	Configure xe3 as a layer 2 port.
<code>(config-if)#bridge-group 1</code>	Associate bridge to an interface.
<code>(config-if)#switchport mode trunk</code>	Configure port as a trunk.
<code>(config-if)#switchport trunk allowed vlan all</code>	Allow all the VLANs on the xe3 interface.
<code>(config-if)#channel-group 1 mode active</code>	Make port as part of port channel.

Static LAG with RTAG7

SW1

<code>#configure terminal</code>	Enter configure mode.
<code>(config)#bridge 1 protocol mstp</code>	Configure bridge 1 as MSTP bridge.
<code>(config)#vlan 2-10 bridge 1</code>	Configure VLANs
<code>(config)#load-balance rtag7</code>	Enable load-balance for rtag7 globally.
<code>(config)#load-balance rtag7 l2 src-mac dest-mac ether-type vlan</code>	Enabling load-balance rtag7 for l2 with all options.
<code>(config)#load-balance rtag7 ipv4 dest-ipv4 src-ipv4 destl4-port srcl4-port protocol-id</code>	Enabling load-balance rtag7 for ipv4 with all options .
<code>(config)#interface sa1</code>	Enter into port channel interface sa1.
<code>(config-if)#switchport</code>	Configuresa1 as a layer 2 port.
<code>(config-if)#bridge-group 1</code>	Associate bridge to an interface.
<code>(config-if)#switchport mode trunk</code>	Configure port as a trunk.
<code>(config-if)#switchport trunk allowed vlan all</code>	Allow all the VLANs on the sa1 interface.
<code>(config-if)#port-channel load-balance rtag7</code>	Enable rtag7 load-balancing method.
<code>(config)#interface xe1</code>	Enter interface mode.
<code>(config-if)#switchport</code>	Configure xe1 as a layer 2 port.
<code>(config-if)#bridge-group 1</code>	Associate bridge to an interface.
<code>(config-if)#switchport mode trunk</code>	Configure port as a trunk.
<code>(config-if)#switchport trunk allowed vlan all</code>	Allow all the VLANs on the xe1 interface.
<code>(config-if)#static-channel-group 1</code>	Make port as part of Static port channel.
<code>(config-if)#exit</code>	Exit the xe1 interface mode.
<code>(config)#interface xe2</code>	Enter interface mode.

(config-if)#switchport	Configure xe2 as a layer 2 port.
(config-if)#bridge-group 1	Associate bridge to an interface.
(config-if)#switchport mode trunk	Configure port as a trunk.
(config-if)#switchport trunk allowed vlan all	Allow all the VLANs on the xe2 interface.
(config-if)#static-channel-group 1	Make port as part of Static port channel.
(config-if)#exit	Exit the xe2 interface mode.
(config)#interface xe3	Enter interface mode.
(config-if)#switchport	Configure xe3 as a layer 2 port.
(config-if)#bridge-group 1	Associate bridge to an interface.
(config-if)#switchport mode trunk	Configure port as a trunk.
(config-if)#switchport trunk allowed vlan all	Allow all the VLANs on the xe3 interface.
(config-if)#static-channel-group 1	Make port as part of Static port channel.
(config-if)#exit	Exit the xe3 interface mode.

SW2

#configure terminal	Enter configure mode.
(config)#bridge 1 protocol mstp	Configure bridge 1 as MSTP bridge.
(config)#vlan 2-10 bridge 1	Configure VLANs.
(config)#interface sa1	Enter interface mode
(config-if)#switchport	
(config-if)#bridge-group 1	Associate bridge to an interface
(config-if)#switchport mode trunk	Configure port as a trunk
(config-if)#switchport trunk allowed vlan all	Allow all the VLANs on the sa1 interface.
(config-if)#exit	
(config)#interface xe1	Enter interface mode.
(config-if)#switchport	Configure xe1 as a layer 2 port.
(config-if)#bridge-group 1	Associate bridge to an interface.
(config-if)#switchport mode trunk	Configure port as a trunk.
(config-if)#switchport trunk allowed vlan all	Allow all the VLANs on the xe1 interface.
(config-if)#static-channel-group 1	Make port as part of Static port channel.
(config-if)#exit	Exit the xe1 interface mode.
(config)#interface xe2	Enter interface mode.
(config-if)#switchport	Configure xe2 as a layer 2 port.
(config-if)#bridge-group 1	Associate bridge to an interface.
(config-if)#switchport mode trunk	Configure port as a trunk.
(config-if)#switchport trunk allowed vlan all	Allow all the VLANs on the xe2 interface.

<code>(config-if)#static-channel-group 1</code>	Make port as part of Static port channel.
<code>(config-if)#exit</code>	Exit the xe2 interface mode.
<code>(config)#interface xe3</code>	Enter interface mode.
<code>(config-if)#switchport</code>	Configure xe3 as a layer 2 port.
<code>(config-if)#bridge-group 1</code>	Associate bridge to an interface.
<code>(config-if)#switchport mode trunk</code>	Configure port as a trunk.
<code>(config-if)#switchport trunk allowed vlan all</code>	Allow all the VLANs on the xe3 interface.
<code>(config-if)#static-channel-group 1</code>	Make port as part of Static port channel.
<code>(config-if)#exit</code>	Exit the xe3 interface mode.

SYSTEM MANAGEMENT COMMAND REFERENCE

Basic Commands	1372
banner motd	1374
cli timestamp	1375
clock set	1376
clock timezone	1377
configure terminal	1378
configure terminal force	1379
copy empty-config startup-config	1380
copy running-config startup-config	1381
crypto pki generate rsa common-name ipv4	1382
debug nsm	1383
debug vm-events	1385
disable	1386
do	1387
enable	1388
enable password	1389
end	1390
exec-timeout	1391
exit	1392
help	1393
history	1394
hostname	1395
line console	1396
line vty (all line mode)	1397
line vty (line mode)	1398
logging cli	1399
logout	1400
max-session	1401
ping	1402
ping (interactive)	1405
port breakout	1407
quit	1409
reload	1410
service advanced-vty	1411
service password-encryption	1412
service terminal-length	1413
show clock	1414

show cli	1415
show cli history	1416
show cli list	1417
show cli list all	1418
show cli modes	1420
show crypto csr	1422
show debugging nsm	1423
show debugging vm-events	1424
show logging cli	1425
show nsm client	1426
show process	1427
show running-config	1428
show running-config switch	1429
show startup-config	1431
show tcp	1432
show timezone	1434
show users	1437
show version	1439
sys-reload	1441
sys-shutdown	1442
terminal width	1443
terminal length	1444
terminal monitor	1445
terminal monitor default	1446
terminal timestamping	1447
terminal default timestamping	1447
traceroute	1449
watch static-mac-movement	1450
write	1451
write terminal	1452
Multi-Line Banner Support	1453
Overview	1453
Options to Configure Multi-Banner Message	1453
Multi-Banner Message Command	1453
Common Management Layer Commands	1456
abort transaction	1458
cancel-commit (WORD)	1459
clear cml commit-history (WORD)	1462
cml auto-config-sync	1463
cml bulk-config	1464

cml commit-history	1465
cml commit-id rollover	1467
cml config-sync check	1468
cml force-unlock config-datastore	1469
cml lock config-datastore	1470
cml logging	1472
cml netconf translation	1473
cml notification	1474
cml unlock config-datastore	1475
cmlsh cli-format	1476
cmlsh multiple-config-session	1477
cmlsh notification	1479
cmlsh transaction	1480
cmlsh transaction limit	1481
commit	1482
confirm-commit (WORD)	1484
commit dry-run	1488
commit-rollback	1489
debug cml	1491
module notification	1492
netconf translation openconfig	1494
save cml commit-history WORD	1495
show cml auto-config-sync state	1497
show cml bulk limit cpu state	1498
show cml cli-error status	1499
show cml commit-history state	1500
show cml commit-id rollover state	1501
show cml config-sync detail	1502
show cml database-dump	1503
show cml config-datastore lock status	1504
show cml notification status	1505
show cmlsh multiple-config-session status	1506
show cmlsh notification status	1507
show commit list	1507
show json/xml commit config WORD	1509
show json/xml commit diff WORD WORD	1510
show max-transaction limit	1512
show module-info	1513
show running-config notification	1515
show system restore failures	1516

show transaction current	1517
show transaction last-aborted	1518
show xml/json OBJECT_NAME	1519
Remote Management Commands	1522
copy running-config	1524
copy running-config (interactive)	1525
copy startup-config	1526
copy startup-config (interactive)	1527
copy system file	1528
copy system file (interactive)	1530
copy ftp startup-config	1532
copy scp filepath	1533
copy scp startup-config	1534
copy sftp startup-config	1535
copy tftp startup-config	1536
copy http startup-config	1537
copy ftp startup-config (interactive)	1538
copy scp startup-config (interactive)	1539
copy sftp startup-config (interactive)	1540
copy tftp startup-config (interactive)	1541
copy http startup-config (interactive)	1542
copy file startup-config	1543
load-config	1544
Interface Commands	1545
admin-group	1548
bandwidth	1549
bandwidth-measurement static uni-available-bandwidth	1550
bandwidth-measurement static uni-residual-bandwidth	1551
bandwidth-measurement static uni-utilized-bandwidth	1552
clear hardware-discard-counters	1553
clear interface counters	1554
clear interface cpu counters	1555
clear interface fec	1556
clear ip prefix-list	1557
clear ipv6 neighbors	1558
clear ipv6 prefix-list	1559
debounce-time	1560
delay-measurement dynamic twamp	1562
delay-measurement a-bit-min-max-delay-threshold	1564
delay-measurement static	1565

delay-measurement a-bit-delay-threshold	1567
default-interface l2protocol	1567
default-interface load-interval	1569
default-interface type mtu	1569
description	1571
duplex	1572
fec	1573
flowcontrol	1575
hardware-profile portmode	1577
if-arbiter	1578
interface	1579
ip address A.B.C.D/M	1580
ip address dhcp	1581
ip forwarding	1582
ip prefix-list	1583
ip proxy-arp	1585
ip remote-address	1586
ip unnumbered	1587
ip vrf forwarding	1588
ipv6 address	1589
ipv6 forwarding	1590
ipv6 prefix-list	1591
ipv6 unnumbered	1593
link-debounce-time	1594
load interval	1595
loopback	1596
loss-measurement dynamic	1597
loss-measurement uni-link-loss	1598
mac-address	1599
monitor speed	1600
monitor queue-drops	1601
monitor speed threshold	1602
mtu	1603
multicast	1605
show flowcontrol	1606
show hardware-discard-counters	1608
show interface	1610
show interface capabilities	1613
show interface counters	1615
show interface counters drop-stats	1618

show interface counters error-stats	1621
show interface counters (indiscard-stats outdiscard-stats)	1623
show interface counters protocol	1626
show interface counters queue-drop-stats	1627
show interface counters queue-stats	1628
show interface counters rate	1630
show interface counters speed	1632
show interface counters summary	1633
show interface fec	1635
show ip forwarding	1637
show ip interface	1638
show ip prefix-list	1640
show ip route	1642
show ip route A.B.C.D/M longer-prefixes	1644
show ip vrf	1652
show ipv6 forwarding	1653
show ipv6 interface brief	1654
show ipv6 route	1656
show ipv6 prefix-list	1658
show hosts	1660
show running-config interface	1662
show running-config interface ip	1664
show running-config interface ipv6	1665
show running-config ip	1666
show running-config ipv6	1667
show running-config prefix-list	1668
shutdown	1669
speed	1670
switchport	1673
switchport allowed ethertype	1675
switchport protected	1676
transceiver	1677
tx cdr-bypass	1679
rx cdr-bypass	1680
Time Range Commands	1681
end-time (absolute)	1682
end-time after (relative)	1684
frequency	1685
frequency days (specific days)	1686
start-time (absolute)	1687

start-time after (relative)	1689
start-time now (current)	1690
time-range	1691
System Configure Mode Commands	1692
delay-profile interfaces	1693
delay-profile interfaces subcommands	1694
forwarding custom-profile	1696
forwarding profile	1698
ip redirects	1700
load-balance enable	1701
hardware-profile filter (XGS)	1704
load-balance rtag7	1706
load-balance rtag7 all-lag-if	1708
load-balance rtag7 hash	1709
load-balance rtag7 macro-flow	1710
show forwarding profile limit	1711
show hardware-profile filters	1713
Linux Shell Commands	1715
Commit Rollback	1716
Overview	1716
Commit Rollback Characteristics	1716
Benefits	1716
Prerequisites	1716
show commit list	1716
commit-rollback	1717
clear cml commit-history (WORD)	1719
cml commit-history	1720
cml commit-id rollover	1722

Basic Commands

This chapter describes basic commands.

banner motd	1374
cli timestamp	1375
clock set	1376
clock timezone	1377
configure terminal	1378
configure terminal force	1379
copy empty-config startup-config	1380
copy running-config startup-config	1381
crypto pki generate rsa common-name ipv4	1382
debug nsm	1383
debug vm-events	1385
disable	1386
do	1387
enable	1388
enable password	1389
end	1390
exec-timeout	1391
exit	1392
help	1393
history	1394
hostname	1395
line console	1396
line vty (all line mode)	1397
line vty (line mode)	1398
logging cli	1399
logout	1400
max-session	1401
ping	1402
ping (interactive)	1405
port breakout	1407
quit	1409
reload	1410
service advanced-vty	1411
service password-encryption	1412
service terminal-length	1413
show clock	1414

show cli	1415
show cli history	1416
show cli list	1417
show cli list all	1418
show cli modes	1420
show crypto csr	1422
show debugging nsm	1423
show debugging vm-events	1424
show logging cli	1425
show nsm client	1426
show process	1427
show running-config	1428
show running-config switch	1429
show startup-config	1431
show tcp	1432
show timezone	1434
show users	1437
show version	1439
sys-reload	1441
sys-shutdown	1442
terminal width	1443
terminal length	1444
terminal monitor	1445
terminal monitor default	1446
terminal timestamping	1447
terminal default timestamping	1447
traceroute	1449
watch static-mac-movement	1450
write	1451
write terminal	1452

banner motd

Use this command to set the message of the day (motd) at login.

After giving this command, you must write to memory using the [terminal monitor \(page 1445\)](#) command. If you do not write to memory, the new message of the day is not available after the device reboots.

Use the **no** parameter to not display a banner message at login. To configure multi-line banner message, see [Multi-Banner Message Command \(page 1453\)](#) command.

Command Syntax

```
banner motd LINE
banner motd default
banner motd file URL
no banner motd
```

Parameters

LINE

Custom message of the day.

default

Default message of the day.

file

A file input to set a custom message of the day.

URL

The file path and name containing the banner message.

Default

By default, the following banner is displayed after logging in:

```
OcNOS version 1.3.4.268-DC-MPLS-ZEBM 09/27/2018 13:44:22
```

Command Mode

Configure mode

Applicability

This command was introduced before OcNOS version 1.3.

Examples

```
#configure terminal
(config)#banner motd default

#configure terminal
(config)#no banner motd
```

cli timestamp

Use this command to enable timestamp print after every show command line interfaces.

Use the `no` form of this command disable the timestamp print.

Command Syntax

```
cli timestamp
```

Parameters

None

Default

Disabled

Command Mode

Configure mode

Applicability

This command was introduced before OcNOS version 6.5.2.

Example

```
OcNOS#configure terminal
Enter configuration commands, one per line. End with CNTL/Z.
OcNOS(config)#cli timestamp
OcNOS(config)#commit
OcNOS(config)#exit
OcNOS#
OcNOS#configure terminal
Enter configuration commands, one per line. End with CNTL/Z.
OcNOS(config)#no cli timestamp
OcNOS(config)#commit
OcNOS(config)#exit
```

Validation Example

```
Virgo-6#show ip ospf neighbor
! [execution timestamp : 2024 May 14 08:57:44]
Virgo-6#
Virgo-6#show mpls forwarding-table
! [execution timestamp : 2024 May 14 08:57:49]
Codes: > - installed FTN, * - selected FTN, p - stale FTN, ! - using backup
       B - BGP FTN, K - CLI FTN, (t) - tunnel, P - SR Policy FTN, (b) - bypass,
       L - LDP FTN, R - RSVP-TE FTN, S - SNMP FTN, I - IGP-Shortcut,
       U - unknown FTN, O - SR-OSPF FTN, i - SR-ISIS FTN, k - SR-CLI FTN
       (m) - FTN mapped over multipath transport, (e) - FTN is ECMP

FTN-ECMP LDP: Disabled
Code  FEC  FTN-ID  Nhlfe-ID  Tunnel-ID  Pri  Out-Label  Out-Intf  ELC  Nexthop  UpTime
```

clock set

Use this command to set the system time manually.

Command Syntax

```
clock set HH:MM:SS <1-31> MONTH <2000-2099>
```

Parameters

HH:MM:SS

Time of day: hour, minutes, seconds

<1-31>

Day of month

MONTH

Month of the year (january-december)

<2000-2099>

Year

Default

N/A

Command Mode

Execution mode and Privileged execution mode

Applicability

This command was introduced before OcNOS version 1.3.

Examples

```
#clock set 18:30:00 13 january 2021
18:30:00 UTC Wed Jan 13 2021
```

clock timezone

Use this command to set the system time zone.

Use `no` form of this command to set the default system time zone (UTC).

Command Syntax

```
clock timezone (WORD)
no clock timezone
```

Parameters

WORD

Timezone name. Use 'show timezone' to get the list of city names.

Default

By default, system time zone is UTC

Command Mode

Configure mode

Applicability

This command was introduced before OcNOS version 1.3.

Examples

```
(config)#clock timezone Los_Angeles
```

configure terminal

Use this command to enter configure mode.

When multiple CLI sessions are enabled with the command, configure terminal will not acquire a running datastore lock.

Command Syntax

```
configure terminal
```

Parameters

None

Default

No default value is specified

Command Mode

Privileged execution mode

Applicability

This command was introduced before OcNOS version 1.3.

Example

The following example shows entering configure mode (note the change in the command prompt).

```
#configure terminal  
(config)#
```

configure terminal force

Use the configure terminal force command to kick out the configure command mode to privileged EXEC mode, if there is any session already in configure command mode.



Note: Configure terminal force with option 0 or without any option indicates immediate kick out the session which is locked to configure command mode. Similarly, configure terminal force with option of any value indicates session locked to configure command mode will be exited to privileged Exec mode after the specified number of seconds completed.

When multiple CLI sessions are enabled with the command, configure terminal force has no effect because configuration mode is allowed for multiple users simultaneously.

Command Syntax

```
configure terminal force <0-600|>
```

Parameters

<0-600>

Timeout value in seconds for the session in config mode to exit to Privileged

Default

None

Command Mode

Privileged execution mode

Applicability

This command was introduced before OcNOS version 1.3.

Example

```
#configure terminal force 0  
#
```

copy empty-config startup-config

Use this command to clear the contents of the startup configuration.

Command Syntax

```
copy empty-config startup-config
```

Parameters

None

Default

None

Command Mode

Privileged execution mode

Applicability

This command was introduced before OcNOS version 1.3.

Example

```
#copy empty-config startup-config  
#
```

copy running-config startup-config

Use this command to write the configuration to the file used at startup. This is the same as the [write](#) command.

Command Syntax

```
copy running-config startup-config
```

Parameters

None

Default

None

Command Mode

Privileged execution mode

Applicability

This command was introduced before OcNOS version 1.3.

Example

```
#copy running-config startup-config
Building configuration...
[OK]
#
```

crypto pki generate rsa common-name ipv4

Use this command to generate a private key and Certificate Signing Request (CSR) which are required for OcNOS to establish a Transport Layer Security (TLS) connection with a NetConf client.

Command Syntax

```
crypto pki generate rsa common-name ipv4 IPv4ADDR
```

Parameters

IPv4ADDR

IPv4 address for the Common Name field of the CSR

Default

None

Command Mode

Privileged execution mode

Applicability

This command was introduced in OcNOS version 5.0.

Examples

```
#crypto pki generate rsa common-name ipv4 7.7.7.7
#show crypto csr
-----BEGIN CERTIFICATE REQUEST-----
MIICVzCCAT8CAQAwEjEQMA4GA1UEAwHNy43LjcuNzCCAS1wDQYJKoZIhvcNAQEB
BQADggEPADCCAQoCggEBAMkzIZaxNYPd8PW0hexecUFKq9pJn5IJzJkOQDtoVFOT
zeLPRxBaOt1NVd+lEF+wy3AgnGMw004g4AP7qaE+S5X1vKGAjagtfh/gfDAPDUtM
CpYLMCACM7n76OmyP9eUpkMbOSPkZDIBZfjUMxDTFwkzCBH+BF6SkSxtA24NUA9z
5heCIb1ArXYjdlIeB+9FfiVdOZ5yxQsLY8604ONL7Up1766SArGQo6oZ1dJ+bc91
sQVCEpF40SdCNn+Uw3R0cPfQF81BJD4H0EHf1VnHtYJwQ1yax6qc5ghT9R/rABDa
BFB3R09Qpjv4Ihd/MyrdQmEIoxHeNNvSGDj9+eiEpksCAwEAaAAMA0GCSqGSIb3
DQEBCwUAA4IBAQAwxKqMnf3yiL+pmpwvE+gU8KVp3i4cvD13Vjh7IQMkCT47WPam
DUiYgwk+dPVAI+iWZq4qTvUNn6xahOyN5rnkTz9eipsQ1YHPpZB7hj5fimWwzJws
m4Tun0GZieEBCROqUpbuW+6QDvtR3XSzHhdGGSIteZv9cYyKhNu007okwr67c2Ea
11B7PcuiltOb4wj3xjqaO/ENDG+nmdUPaIKZrAwf2fEOarOaHgKwcl1AHHbusbJWL
qh0fA1OyVgfvjg/WuCPP6Peg/Cpla7bDWqeGYt9vFTtekKoOMQLzJw16oINbtBCCw
DZJpeaQpUhFm+ZOjwibZ5NGPBRSTuYncp5xJ
-----END CERTIFICATE REQUEST-----
#
```

debug nsm

Use this command to enable NSM debugging.

Use the **no** form of this command to disable NSM debugging.

Command Syntax

```
debug nsm (all|)
no debug nsm (all|)

debug nsm bfd
no debug nsm bfd

debug nsm events
no debug nsm events

debug nsm hal (all|) debug
debug nsm hal events
no debug nsm hal (all|)
no debug nsm hal events

debug nsm packet (recv|send|) (detail|)
no debug nsm packet (recv|send|) (detail|)
```

Parameters

all

Enable all debugging.

bfd

Debug BFD events.

events

Debug NSM events.

hal

Debug HAL.

events

Debug HAL events.

packet

Debug packet events.

recv

Debug received packets.

send

Debug sent packets.

detail

Show detailed packet information.

Default

By default, debugging is disabled.

Command Mode

Execution mode, Privileged execution mode, and Configure mode

Applicability

This command was introduced before OcNOS version 1.3.

Examples

```
#debug nsm all
#
#debug nsm bfd
#
#debug nsm events
#
#debug nsm hal all
#
#debug nsm packet
#
#debug nsm packet recv detail
```

debug vm-events

Use this command to enable debug logs for Guest VM events

Use the no form of this command to disable debug logs for Guest VM events

Command Syntax

```
debug vm-events  
no debug vm-events
```

Parameters

None

Default

None

Command Mode

Configure mode and Execution mode

Applicability

This command was introduced before OcNOS version 6.1.0

Examples

```
#configure terminal  
(config)#debug vm-events
```

disable

Use this command from to exit privileged exec mode and return to exec mode. This is the only command that allows you to go back to exec mode. The [exit \(page 1392\)](#) or [quit \(page 1409\)](#) commands in privileged exec mode end the session without returning to exec mode.

Command Syntax

```
disable
```

Parameters

None

Default

None

Command Mode

Privileged execution mode

Applicability

This command was introduced before OcNOS version 1.3.

Example

```
#disable  
>
```

do

Use this command to run several exec mode or privileged exec mode commands from configure mode. The commands that can be run from configure mode using **do** are: **show**, **clear**, **debug**, **ping**, **traceroute**, **write**, and **no debug**.

Command Syntax

```
do LINE
```

Parameters

LINE

Command and its parameters.

Default

None

Command Mode

Configure mode

Applicability

This command was introduced before OcNOS version 1.3.

Example

```
#configure terminal
#(config)#do show interface
Interface lo
  Hardware is Loopback index 1 metric 1 mtu 16436 duplex-half arp ageing timeout 25
  <UP,LOOPBACK,RUNNING>
  VRF Binding: Not bound
  Label switching is disabled
  No Virtual Circuit configured
  Administrative Group(s): None
  DSTE Bandwidth Constraint Mode is MAM
  inet 4.4.4.40/32 secondary
  inet 127.0.0.1/8
  inet6 ::1/128
  Interface Gifindex: 3
  Number of Data Links: 0
  GMPLS Switching Capability Type:
    Packet-Switch Capable-1 (PSC-1)
  GMPLS Encoding Type: Packet
  Minimum LSP Bandwidth 0
    input packets 10026, bytes 730660, dropped 0, multicast packets 0
    input errors 0, length 0, overrun 0, CRC 0, frame 0, fifo 0, missed 0
    output packets 10026, bytes 730660, dropped 0
    output errors 0, aborted 0, carrier 0, fifo 0, heartbeat 0, window 0
    collisions 0
#
```

enable

Use this command to enter privileged exec command mode.

Command Syntax

```
enable
```

Parameters

None

Default

None

Command Mode

Execution mode

Applicability

This command was introduced before OcNOS version 1.3.

Example

The following example shows entering the Privileged Exec mode (note the change in the command prompt).

```
>enable  
#
```

enable password

Use this command to change or create a password to use when entering enable mode.



Note: Only network administrators can execute this command. For more, see the [username \(page 350\)](#) command.

There are two methods to enable a password:

- Plain Password: a clear text string that appears in the configuration file.
- Encrypted Password: An encrypted password does not display in the configuration file; instead, it displays as an encrypted string. First, use this command to create a password. Then, use the [service password-encryption \(page 1412\)](#) command to encrypt the password.

Use the `no` parameter to disable the password.

Command Syntax

```
enable password LINE
no enable password
no enable password LINE
```

Parameters

LINE

Password string, up to 8 alpha-numeric characters, including spaces. The string cannot begin with a number.

Default

None

Command Mode

Configure mode

Applicability

This command was introduced before OcNOS version 1.3.

Examples

```
#configure terminal
(config)#enable password mypasswd
```

end

Use this command to return to privileged exec command mode from any other advanced command mode.

Command Syntax

```
end
```

Parameters

None

Default

None

Command Mode

All command modes

Applicability

This command was introduced before OcNOS version 1.3.

Example

The following example shows returning to privileged exec mode directly from interface mode.

```
#configure terminal
(config)#interface eth0
(config-if)#end
#
```

exec-timeout

Use this command to set the interval the command interpreter waits for user input detected. That is, this sets the time a telnet session waits for an idle VTY session before it times out. A value of zero minutes and zero seconds (0 and 0) causes the session to wait indefinitely.

Use the **no** parameter to disable the wait interval.

Command Syntax

```
exec-timeout <0-35791> (<0-2147483>|)
no exec-timeout
```

Parameters

<0-35791>

Timeout value in minutes.

<0-2147483>

Timeout value in seconds.

Default

None

Command Mode

Line mode

Applicability

This command was introduced before OcNOS version 1.3.

Example

In the following example, the telnet session will timeout after 2 minutes, 30 seconds if there is no response from the user.

```
Router#configure terminal
Router(config)#line vty 23 66
Router(config-line)#exec-timeout 2 30
```

exit

Use the exit command to leave the current mode and return to the previous mode. This command is available in exec mode and all higher CLI modes. When executed in exec mode or other modes, it ends the session.

Command Syntax

```
exit
```

Parameters

None

Default

None

Command Mode

All command modes

Applicability

This command was introduced before OcNOS version 1.3.

Examples

The following example shows exiting interface mode and returning to configure mode.

```
#configure terminal
(config)#interface eth0
(config-if)#exit
(config)#
```

help

Use this command to display help for the OcNOS command line interface.

Command Syntax

```
help
```

Parameters

None

Default

None

Command Mode

All command modes

Applicability

This command was introduced before OcNOS version 1.3.

Example

```
#help
CLI provides advanced help feature. When you need help,
anytime at the command line please press '?'.

If nothing matches, the help list will be empty and you must backup
until entering a '?' shows the available options.
Two styles of help are provided:
1. Full help is available when you are ready to enter a
   command argument (e.g. 'show ?') and describes each possible
   argument.
2. Partial help is provided when an abbreviated argument is entered
   and you want to know what arguments match the input
   (e.g. 'show ve?'.)
```

history

Use this command to set the maximum number of commands stored in the command history.

Use the `no` parameter to remove the configuration.

Command Syntax

```
history max <0-2147483647>  
no history max
```

Parameters

<0-2147483647>

Number of commands.

Default

None

Command Mode

Line mode

Applicability

This command was introduced before OcNOS version 1.3.

Examples

```
#configure terminal  
(config)#line vty 12 77  
(config-line)#history max 123  
  
(config-line)#no history max
```

hostname

Use this command to set the network name for the device. OcNOS uses this name in system prompts and default configuration filenames.

Setting a host name using this command also sets the host name in the kernel.



Note: After giving the `hostname` command, you must write to memory using the [terminal monitor \(page 1445\)](#) command. If you do not write to memory, the change made by this command (the new host name) is not set after the device reboots.

Use the `no` parameter to disable this function.

Command Syntax

```
hostname WORD
no hostname (WORD|)
```

Parameter

WORD

Network name for a system. Per RFC 952 and RFC 1123, a host name string can contain only the special characters period (".") and hyphen ("-"). These special characters cannot be at the start or end of a host name.

Default

None

Command Mode

Configure mode

Applicability

This command was introduced before OcNOS version 1.3.

Example

```
#configure terminal
(config)#hostname ABC
(config)#

(config)#no hostname
(config)#exit
```

line console

Use the this command to move or change to the line console mode.

Command Syntax

```
line console <0-0>
```

Parameters

<0-0>

First line number.

Default

None

Command Mode

Configure mode

Applicability

This command was introduced before OcNOS version 1.3.

Example

This example enters line mode (note the change in the prompt).

```
#configure terminal
(config)#line console 0
(config-line)#
```

line vty (all line mode)

Use this command to move or change to all line VTY mode.



Note: line vty is just a mode changing command, and it can't exist without sub attributes being configured. i.e exec-timeout.

Command Syntax

```
line vty
```

Parameters

None

Default

None

Command Mode

Configure mode

Applicability

This command was introduced in OcNOS version 3.0.

Example

The following example shows entering all line mode (note the change in the prompt).

```
#configure terminal
(config)#line vty
(config-all-line)#exit
(config)#
```

line vty (line mode)

Use this command to move or change to VTY mode. This command is used to connect to a protocol daemon. This configuration is necessary for any session. This configuration should be in the daemon's config file before starting the daemon.

Use the **no** parameter to disable this command.



Note: line vty is just a mode changing command, and it can't exist without sub attributes being configured. i.e exec-timeout.

Command Syntax

```
line vty <0-871> <0-871>
no line vty <0-871> (<0-871>|)
```

Parameters

<0-871>

Specify the first line number.

<0-871>

Specify the last line number.



Note: Configurations (exec-timeout) performed under this mode, affects only the current VTY session.

Default

None

Command Mode

Configure mode

Applicability

This command was introduced before OcNOS version 1.3.

Example

The following example shows entering line mode (note the change in the prompt).

```
#configure terminal
(config)#line vty 9
(config-line)#exit
(config)#no line vty 9
```

logging cli

Use this command to enable logging commands entered by all users.

Use the `no` parameter to disable logging commands entered by all users.

Command Syntax

```
logging cli  
no logging cli
```

Parameters

None

Default

None

Command Mode

Configure mode

Applicability

This command was introduced before OcNOS version 1.3.

Example

```
#configure terminal  
(config)#logging cli  
(config)#no logging cli
```

logout

Use this command to exit the OcNOS shell. It presents only in exec mode, on execution it will exit from the exec mode.

Command Syntax

```
logout
```

Parameters

None

Default

None

Command Mode

Execution mode

Applicability

This command was introduced before OcNOS version 1.3.

Example

```
>logout
login:
>enable
en#logout
>
```

max-session

Use this command to set maximum VTY session limit.

Use `no` form of this command to unset session-limit.

User can configure session-limit for Telnet and SSH sessions separately but this max-session parameter value takes the precedence to restrict the maximum number of sessions. If user configured this max-session to be 4, then the device would allow only maximum of 4 SSH and Telnet sessions collectively irrespective of the individual SSH and Telnet max-session configuration. Active sessions won't be disturbed even if the configured max-session limit is lesser than the current active sessions.

Command syntax

```
max-session <1-40>
```

Parameters

<1-40>

Number of sessions

Default

By default, 40 sessions are allowed.

Command Mode

Line mode

Applicability

This command is introduced in OcNOS version 5.0

Example

In the following example max-session is configured as 4, thus the device would allow only 4 management sessions of SSH and Telnet collectively.

```
#configure terminal
(config)#line vty
(config-all-line)#max-session 5
(config-all-line)#commit
(config-all-line)#exit
(config)#exit
```

ping

Use this command to send echo messages to another host.



Note: When data packets copied to cpu due to destination lookup fail, both data packets and icmp echo request packets processed in cpu through same cpu queue and it may happen that ping fails due to congestion. In such cases, to check connectivity, please use interactive ping command and update tos value 192. Refer [ping \(interactive\) \(page 1405\)](#) for the interactive ping command.

Command Syntax

```
ping WORD (broadcast | count <1-2147483647> | datasize <36-18024> | interface IFNAME| source-ip
A.B.C.D | interval <0-3600> | timeout <0-3600>|) (vrf (NAME|management)|)
ping ip WORD (broadcast | count <1-2147483647> | datasize <36-18024> | interface IFNAME| source-ip
A.B.C.D | interval <0-3600> | timeout <0-3600>|) (vrf (NAME|management)|)
ping ipv6 WORD (broadcast | count <1-2147483647> | datasize <36-18024> | interface IFNAME| source-ip
X:X::X:X | interval <0-3600> | timeout <0-3600>|) (vrf (NAME|management)|)
```

Parameters

WORD

Destination address (in A.B.C.D format for IPv4 or X:X::X:X for IPv6) or host name.

ip

IPv4 echo.

WORD

Destination address in A.B.C.D format or host name.

ipv6

IPv6 echo.

WORD

Destination address in X:X::X:X format or host name.

interface

Interface name through which the **ICMP**¹ packets to be sent.

IFNAME

Interface's name

source-ip

Source IP to be used in ICMP packet.

A.B.C.D

Source IPv4 address in the ping.

X:X::X:X

Source IPv6 address in the ping.

vrf

Virtual Routing and Forwarding instance.

¹Internet Control Message Protocol (ICMP) is a fundamental protocol used in networking to relay error messages and operational information.

NAME

VRF¹ instance name.

management

Management VRF.

broadcast

Allow broadcast

count

Ping repeat count

<1-2147483647>

Repeat count value

datasize

Datagram size

<36-18024>

Data size in bytes (Default value is 100)

interval

Interval between sending each packet

<0-3600>

Interval value (Default value is 1)

timeout

Response timeout

<0-3600>

Timeout in seconds (Default value is 2)

Default

None

Command Mode

Privileged execution mode

Applicability

This command was introduced before OcNOS version 1.3.

Examples

```
>enable
#ping 20.20.20.1 vrf management
Press CTRL+C to exit
PING 20.20.20.1 (20.20.20.1) 56(84) bytes of data.
64 bytes from 20.20.20.1: icmp_seq=1 ttl=64 time=0.032 ms
64 bytes from 20.20.20.1: icmp_seq=2 ttl=64 time=0.035 ms
64 bytes from 20.20.20.1: icmp_seq=3 ttl=64 time=0.033 ms
64 bytes from 20.20.20.1: icmp_seq=4 ttl=64 time=0.034 ms
64 bytes from 20.20.20.1: icmp_seq=5 ttl=64 time=0.034 ms
64 bytes from 20.20.20.1: icmp_seq=6 ttl=64 time=0.036 ms
64 bytes from 20.20.20.1: icmp_seq=7 ttl=64 time=0.036 ms
64 bytes from 20.20.20.1: icmp_seq=8 ttl=64 time=0.036 ms
```

¹Virtual Routing and Forwarding

```
--- 20.20.20.1 ping statistics ---
8 packets transmitted, 8 received, 0% packet loss, time 6999ms
rtt min/avg/max/mdev = 0.032/0.034/0.036/0.006 ms

#ping ipv6 3001:db8:0:1::129 vrf management
Press CTRL+C to exit
PING 3001:db8:0:1::129(3001:db8:0:1::129) 56 data bytes
64 bytes from 3001:db8:0:1::129: icmp_seq=1 ttl=64 time=0.038 ms
64 bytes from 3001:db8:0:1::129: icmp_seq=2 ttl=64 time=0.047 ms
64 bytes from 3001:db8:0:1::129: icmp_seq=3 ttl=64 time=0.047 ms
64 bytes from 3001:db8:0:1::129: icmp_seq=4 ttl=64 time=0.049 ms
64 bytes from 3001:db8:0:1::129: icmp_seq=5 ttl=64 time=0.044 ms
64 bytes from 3001:db8:0:1::129: icmp_seq=6 ttl=64 time=0.048 ms
64 bytes from 3001:db8:0:1::129: icmp_seq=7 ttl=64 time=0.046 ms
64 bytes from 3001:db8:0:1::129: icmp_seq=8 ttl=64 time=0.048 ms

--- 3001:db8:0:1::129 ping statistics ---
8 packets transmitted, 8 received, 0% packet loss, time 6999ms

#ping 11.11.11.1 source-ip 11.11.11.2 count 5 timeout 1
Press CTRL+C to exit
PING 11.11.11.1 (11.11.11.1) from 11.11.11.2 : 100(128) bytes of data.
108 bytes from 11.11.11.1: icmp_seq=1 ttl=64 time=0.437 ms
108 bytes from 11.11.11.1: icmp_seq=2 ttl=64 time=0.359 ms
108 bytes from 11.11.11.1: icmp_seq=3 ttl=64 time=0.314 ms
108 bytes from 11.11.11.1: icmp_seq=4 ttl=64 time=0.340 ms
108 bytes from 11.11.11.1: icmp_seq=5 ttl=64 time=0.299 ms

--- 11.11.11.1 ping statistics ---
5 packets transmitted, 5 received, 0% packet loss, time 97ms
rtt min/avg/max/mdev = 0.299/0.349/0.437/0.053 ms
#ping 9.2.27.17 source-ip 1.1.17.12 count 10 timeout 5 interval 10 broadcast vrf management
Press CTRL+C to exit
PING 9.2.27.17 (9.2.27.17) from 1.1.17.12 : 100(128) bytes of data.
108 bytes from 9.2.27.17: icmp_seq=1 ttl=64 time=0.211 ms
108 bytes from 9.2.27.17: icmp_seq=2 ttl=64 time=0.171 ms
108 bytes from 9.2.27.17: icmp_seq=3 ttl=64 time=0.182 ms
108 bytes from 9.2.27.17: icmp_seq=4 ttl=64 time=0.183 ms
108 bytes from 9.2.27.17: icmp_seq=5 ttl=64 time=0.182 ms
108 bytes from 9.2.27.17: icmp_seq=6 ttl=64 time=0.175 ms
108 bytes from 9.2.27.17: icmp_seq=7 ttl=64 time=0.186 ms
108 bytes from 9.2.27.17: icmp_seq=8 ttl=64 time=0.173 ms
108 bytes from 9.2.27.17: icmp_seq=9 ttl=64 time=0.163 ms
108 bytes from 9.2.27.17: icmp_seq=10 ttl=64 time=0.197 ms

--- 9.2.27.17 ping statistics ---
10 packets transmitted, 10 received, 0% packet loss, time 331ms
rtt min/avg/max/mdev = 0.163/0.182/0.211/0.016 ms
#
```

ping (interactive)

Use this command to send echo messages to another host interactively. You are prompted with options supported by the command.

Command Syntax

```
ping
```

Parameters

None

Default

None

Command Mode

Privileged execution mode

Applicability

This command was introduced before OcNOS version 1.3.

Examples

```
>enable
#ping
Protocol [ip]:
Target IP address: 20.20.20.1
Name of the VRF : management
Repeat count [5]: 6
Time Interval in Sec [1]: 2.2
Datagram size [100]:
Timeout in seconds [2]:
Extended commands [n]:
Ping Broadcast? Then -b [n]:
PING 20.20.20.1 (20.20.20.1) 100(128) bytes of data.
108 bytes from 20.20.20.1: icmp_seq=1 ttl=64 time=0.038 ms
108 bytes from 20.20.20.1: icmp_seq=2 ttl=64 time=0.038 ms
108 bytes from 20.20.20.1: icmp_seq=3 ttl=64 time=0.038 ms
108 bytes from 20.20.20.1: icmp_seq=4 ttl=64 time=0.036 ms
108 bytes from 20.20.20.1: icmp_seq=5 ttl=64 time=0.037 ms
108 bytes from 20.20.20.1: icmp_seq=6 ttl=64 time=0.034 ms
--- 20.20.20.1 ping statistics ---
6 packets transmitted, 6 received, 0% packet loss, time 11000ms
rtt min/avg/max/mdev = 0.034/0.036/0.038/0.007 ms
#ping
Protocol [ip]: ipv6
Target IP address: 3001:db8:0:1::129
Name of the VRF : management
Repeat count [5]:
Time Interval in Sec [1]:
Datagram size [100]:
Timeout in seconds [2]:
Extended commands [n]:
PING 3001:db8:0:1::129(3001:db8:0:1::129) 100 data bytes
```

```

108 bytes from 3001:db8:0:1::129: icmp_seq=1 ttl=64 time=0.050 ms
108 bytes from 3001:db8:0:1::129: icmp_seq=2 ttl=64 time=0.047 ms
108 bytes from 3001:db8:0:1::129: icmp_seq=3 ttl=64 time=0.042 ms
108 bytes from 3001:db8:0:1::129: icmp_seq=4 ttl=64 time=0.048 ms
108 bytes from 3001:db8:0:1::129: icmp_seq=5 ttl=64 time=0.051 ms
--- 3001:db8:0:1::129 ping statistics ---
5 packets transmitted, 5 received, 0% packet loss, time 4000ms
rtt min/avg/max/mdev = 0.042/0.047/0.051/0.008 ms

```

The input prompts are described in [Table 80](#):

Table 80. ping output fields

Protocol [ip]	IPv4 or IPv6. The default is IPv4 if not specified.
Target IP address	IPv4 or IPv6 address or host name.
Name of the VRF ¹	Name of the Virtual Routing and Forwarding instance.
Repeat count [5]	Number of ping packets to send. The default is 5 if not specified.
Time Interval in Sec [1]	Time interval between two ping packets. The default is 1 second if not specified.
Datagram size [100]	Ping packet size. The default is 100 bytes if not specified.
Timeout in seconds [2]	Time to wait for ping reply. The default is 2 seconds if not specified.
Extended commands [n]	Options for extended ping. The default is “no”.
Source address or interface	Source address or interface.
Type of service [0]	Types of service. The default is 0 if not specified.
Set DF bit in IP header? [no]	Do not fragment bit. The default value is “no” if not specified.
Data pattern [0xABCD]	Specify a pattern.
Ping Broadcast? Then -b [n]	Broadcast ping. The default is “no”. For a broadcast address, the value should be “y”.

¹Virtual Routing and Forwarding

port breakout

Use this command for the port breakout configuration.



Notes:

- Application and related breakout types will differ for transceivers based on the make or vendor. Check the related applications and breakout type using the command "#show qsfp-dd <port no> advertisement applications" and configure application, corresponding breakout type as network needed.
- serdes command is applicable only for 1X100g and 1X200g breakout modes. If we configure serdes 25g then each lane will be configured with 25g.
- The 100g (ce) ports support 4X10g, 4X25g, and 2X50g breakout modes only.

Command Syntax

```
port IFNAME breakout (4X10g|4X25g|2X50g)
port IFNAME breakout
(1X100g|1X200g|2X100g|2X200g|2X50g|3X100g|4X100g|4X10g|4X25g|4X50g|8X10g|8X25g|8X50g)
port IFNAME breakout (2X100g|1X100g) (serdes (25g)|)
no port IFNAME breakout
```

Parameters

IFNAME

Interface Name.

1X100g

split to 1X100g(default serdes is 50G).

1X200g

split to 1X200g.

2X100g

split to 2X100g(default serdes is 50G).

2X200g

split to 2X200g.

2X50g

split to 2X50g.

3X100g

split to 3X100g.

4X100g

split to 4X100g.

4X10g

split to 4X10g.

4X25g

split to 4X25g.

4X50g

split to 4X50g.

8X10g

split to 8X10g.

8X25g

split to 8X25g.

8X50g

split to 8X50g.

Serdes 25g

configure serdes 25g.

Default

None

Command Mode

Configure mode

Applicability

This command was introduced before OcNOS version 6.4.

Examples

```
#Configuring port breakout:
OcNOS(config)#port cd2 breakout 1X100g
OcNOS(config)#port cd3 breakout 1X200g
OcNOS(config)#port cd4 breakout 2X100g
OcNOS(config)#port cd5 breakout 2X200g
OcNOS(config)#port cd6 breakout 2X50g
OcNOS(config)#port cd7 breakout 3X100g
OcNOS(config)#port cd8 breakout 4X100g
OcNOS(config)#port cd9 breakout 4X10g
OcNOS(config)#port cd10 breakout 4X25g
OcNOS(config)#port cd11 breakout 4X50g
OcNOS(config)#port cd12 breakout 8X10g
OcNOS(config)#port cd13 breakout 8X25g
OcNOS(config)#port cd14 breakout 8X50g
Configuring port-breakout with serdes option:
OcNOS(config)#port cd15 breakout 1X100g serdes 25g
OcNOS(config)#port cd16 breakout 2X100g serdes 25g
Unconfiguring the port-breakout:
OcNOS(config)#no port cd5 breakout
```

quit

Use this command to leave the current mode and return to the previous mode. When executed in an exec mode, it terminates the session and logs you out.

Command Syntax

```
quit
```

Parameters

None

Default

None

Command Mode

All modes

Applicability

This command was introduced before OcNOS version 1.3.

Examples

```
#configure terminal
(config)#interface eth1
(config-if)#quit
(config)#quit
#quit
>enable
#quit
[root@TSUP-123 sbin]#
```

reload

Use this command to shut down the device and perform a cold restart. You call this command when:

- You detect a configuration issue such as `show running-config` displaying a configuration but when you try to remove that configuration, you get a message that it is not configured.
- You have replaced the start-up configuration file (in this case you specify the `flush-db` parameter).

Command Syntax

```
reload (flush-db|)
```

Parameters

flush-db

Delete the database file and recreate it from the start-up configuration file.

Default

None

Command Mode

Privileged execution mode

Applicability

This command was introduced before OcNOS version 1.3.

Examples

This example shows replacing a start-up configuration file and then synchronizing it to the configuration database:

```
#copy file /home/TEST.conf startup-config
Copy Success
#
#reload flush-db
The system has unsaved changes.
Would you like to save them now? (y/n): n

Configuration Not Saved!
Are you sure you would like to reset the system? (y/n): y
For both of these prompts, you must specify whether to save or discard the changes. Abnormal
termination of the session without these inputs can impact the system behavior.
For the unsaved changes prompt:
Would you like to save them now?
You should always say "no" to this prompt because otherwise the command takes the current running
configuration and applies it to the current start-up configuration.
```

service advanced-vty

Use this command to set multiple options to list when the tab key is pressed while entering a command. This feature applies to commands with more than one option.

Use the `no` parameter to not list options when the tab key is pressed while entering a command.

Command Syntax

```
service advanced-vty
no service advanced-vty
```

Parameters

None

Default

None

Command Mode

Configure mode

Applicability

This command was introduced before OcNOS version 1.3.

Examples

```
#configure terminal
(config)#service advanced-vty
(config)#no service advanced-vty
```

service password-encryption

Use this command to encrypt passwords created with the [enable password \(page 1389\)](#) command. Encryption helps prevent observers from reading passwords.

Use the **no** parameter to disable this feature.

Command Syntax

```
service password-encryption
no service password-encryption
```

Parameters

None

Default

None

Command Mode

Configure mode

Applicability

This command was introduced before OcNOS version 1.3.

Example

```
#configure terminal
(config)#enable password mypasswd
(config)#service password-encryption
```

service terminal-length

Use this command to set the number of lines that display at one time on the screen for the current terminal session. Use the `no` parameter to disable this feature.

Command Syntax

```
service terminal-length <0-512>
no service terminal-length (<0-512>|)
```

Parameters

`<0-512>`

Number of lines to display. A value of 0 prevents pauses between screens of output.

Default

None

Command Mode

Configure mode

Applicability

This command was introduced before OcNOS version 1.3.

Example

```
#configure terminal
(config)#service terminal-length 60
```

show clock

Use this command to display the current system time.

Command Syntax

```
show clock
```

Parameters

None

Command Mode

Execution mode and Privileged execution mode

Applicability

This command was introduced before OcNOS version 1.3.

Examples

```
#show clock  
12:54:02 IST Fri Apr 29 2016
```

show cli

Use this command to display the command tree of the current mode.

Command Syntax

```
show cli
```

Parameters

None

Default

None

Command Mode

All command modes

Applicability

This command was introduced before OcNOS version 1.3.

Example

```
#show cli
Exec mode:
+-clear
  +-arp-cache [clear arp-cache]
  +-ethernet
    +-cfm
      +-errors
        +-domain
          +-DOMAIN_NAME [clear ethernet cfm errors (domain DOMAIN_NAME|level LEVEL_ID) (bridge <1-32>|)]
        +-bridge
          +-<1-32> [clear ethernet cfm errors (domain DOMAIN_NAME|level LEVEL_ID) (bridge <1-32>|)]
      +-level
        +-LEVEL_ID [clear ethernet cfm errors (domain DOMAIN_NAME|level LEVEL_ID) (bridge <1-32>|)]
        +-bridge
          +-<1-32> [clear ethernet cfm errors (domain DOMAIN_NAME|level LEVEL_ID) (bridge <1-32>|)]
    +-maintenance-points
      +-remote
        +-domain
          +-DOMAIN_NAME [clear ethernet cfm maintenance-points remote(domain D
--More--
```

show cli history

Use this command to list the commands entered in the current session. The history buffer is cleared automatically upon reboot.

Command Syntax

```
show cli history
show cli history timestamped
```

Parameters

timestamped

Display a timestamped along with the history entry.

Command Mode

Execution mode and Privileged execution mode

Applicability

This command was introduced before OcNOS version 1.3 and the timestamped parameter was introduced in OcNOS version 6.6.0.

Examples

```
#show cli history
 1 en
 2 show ru
 3 con t
 4 show spanning-tree
 5 exit
 6 show cli history

#show cli history timestamped
[2024 Sep 13 17:43:21.122] 1 en
[2024 Sep 13 17:43:23.984] 2 show ru
[2024 Sep 13 17:43:26.715] 3 con t
[2024 Sep 13 17:43:33.068] 4 show spanning-tree
[2024 Sep 13 17:43:37.495] 5 exit
[2024 Sep 13 17:43:50.515] 6 show cli history
[2024 Sep 13 17:43:55.029] 7 show cli history timestamped
```

show cli list

Use this command to display the commands relevant to the current mode.

Command Syntax

```
show cli list
```

Parameters

None

Default

None

Command Mode

All command modes except IPv4 access-list and IPv6 access-list mode.

Applicability

This command was introduced before OcNOS version 6.4.

Examples

```
> show cli list
cat LINE
cd (WORD|)
clear aaa local user lockout username USERNAME
clear access-list NAME counters
clear access-list counters
clear arp access-list NAME counters
clear arp access-list counters
clear arp-cache
clear bgp *
clear bgp * in
clear bgp * in prefix-filter
clear bgp * l2vpn vpls
clear bgp * out
clear bgp * soft
clear bgp * soft in
clear bgp * soft out
clear bgp <1-4294967295>
clear bgp <1-4294967295>
```

show cli list all

Use this command to display all the cli's present in OcNOS device.

Command Syntax

```
show cli list all
```

Parameters

None

Default

None

Command Mode

Execution mode

Applicability

This command was introduced before OcNOS version 6.4.

Example

```
> show cli list all
cat LINE
cd (WORD|)
clear aaa local user lockout username USERNAME
clear access-list NAME counters
clear access-list counters
clear arp access-list NAME counters
clear arp access-list counters
clear arp-cache
clear bgp *
clear bgp * in
clear bgp * in prefix-filter
clear bgp * l2vpn vpls
clear bgp * out
clear bgp * soft
clear bgp * soft in
clear bgp * soft out
clear bgp <1-4294967295>
clear bgp <1-4294967295> in
clear bgp <1-4294967295> in prefix-filter
clear bgp <1-4294967295> l2vpn vpls
clear bgp <1-4294967295> out
clear bgp <1-4294967295> soft
clear bgp <1-4294967295> soft in
clear bgp <1-4294967295> soft out
clear bgp (A.B.C.D|X:X::X:X|WORD)
clear bgp (A.B.C.D|X:X::X:X) in
clear bgp (A.B.C.D|X:X::X:X) in prefix-filter
clear bgp (A.B.C.D|X:X::X:X) l2vpn vpls
clear bgp (A.B.C.D|X:X::X:X) out
clear bgp (A.B.C.D|X:X::X:X) soft
clear bgp (A.B.C.D|X:X::X:X) soft in
```

```
clear bgp X:X::X:X soft out  
clear bgp all *
```

show cli modes

Use this command to display cli modes present in OcNOS.

Command Syntax

```
show cli modes
```

Parameters

None

Default

None

Command Mode

Execution mode

Applicability

This command was introduced before OcNOS version 6.4.

Examples

```
> Mode(4) Exec []
Mode(5) Configure [(config)]
Mode(6) Line configuration [(config-line)]
Mode(12) Key-chain configuration [(config-keychain)]
Mode(13) Key-chain key configuration [(config-keychain-key)]
Mode(14) Virtual-router instance configuration [(config-vr)]
Mode(15) IP VPN Routing/Forwarding instance configuration [(config-vrf)]
Mode(16) Interface configuration [(config-if)]
Mode(24) VPLS configuration [(config-vpls)]
Mode(26) Router configuration [(config-router)]
Mode(27) Router Address Family configuration [(config-router-af)]
Mode(28) Router Address Family configuration [(config-router-af)]
Mode(29) Router Address Family configuration [(config-router-af)]
Mode(30) Router Address Family configuration [(config-router-af)]
Mode(31) Router Address Family configuration [(config-router-af)]
Mode(32) Router configuration [(config-router)]
Mode(33) Router Address Family configuration [(config-router-af)]
Mode(34) Router configuration [(config-router)]
Mode(35) Router configuration [(config-router)]
Mode(36) Router configuration [(config-router)]
Mode(37) Router configuration [(config-router)]
Mode(38) Router Address Family configuration [(config-router-af)]
Mode(46) Router configuration [(config-router)]
Mode(48) Router configuration [(config-router)]
Mode(51) Router configuration [(config-router)]
Mode(52) MPLS Path configuration [(config-path)]
Mode(53) MPLS Trunk configuration [(config-trunk)]
Mode(56) IP Prefix-List configuration [(config-ip-prefix-list)]
Mode(61) IPv6 Prefix-List configuration [(config-ipv6-prefix-list)]
Mode(63) Route Map configuration [(config-route-map)]
Mode(71) MSTI configuration [(config-mst)]
Mode(96) Crypto Map configuration [(config-crypto)]
```

```
Mode(99) RSVP Bypass Tunnel configuration [(config-bypass)]  
--More--
```

show crypto csr

Use this command to display the Certificate Signing Request (CSR) created with the [crypto pki generate rsa common-name ipv4 \(page 1382\)](#) command.

Command Syntax

```
show crypto csr
```

Parameters

None

Default

None

Command Mode

Privileged execution mode

Applicability

This command was introduced in OcNOS version 5.0.

Example

```
#crypto pki generate rsa common-name ipv4 7.7.7.7
#show crypto csr
-----BEGIN CERTIFICATE REQUEST-----
MIICVzCCAT8CAQAwEjEQMA4GA1UEAwHNy43LjcuNzCCASIwDQYJKoZIhvcNAQEB
BQADggEPADCCAQoCggEBAMkzIZaxNYPd8PW0hexecUFKq9pJn5IJzJkOQDtovFOT
zeLPRxBaOt1NVd+1EF+wy3AgnGMw004g4AP7qaE+S5X1vKGAjagtfh/gfDAPDUtM
CpYLMCACM7n76OmyP9eUpkMbOSPkZDIBZfjUMxDTFwkzCBH+BF6SkSxtA24NUA9z
5heCIb1ArXYjdlIeB+9FfiVdOZ5yxQsLY8604ONL7Up1766SArGQo6oZ1dJ+bc91
sQVCEpF40SdCnn+Uw3R0cPfQF81BJD4H0EHf1VnHtYJwQ1yax6qc5ghT9R/rABDa
BFB3R09Qpjv4Ihd/MyrdQmEIoXHeNNvSGDj9+eiEpksCAwEAaAAMA0GCSqGSIb3
DQEBCwUAA4IBAQAwxkQmNf3yiL+pmpwvE+gU8KVp3i4cvD13Vjh7IQMkCT47WPam
DUiYgwk+dPVAI+iWZq4qTvUNn6xahOyN5rnkTz9eipsQ1YHPpZB7hj5fimWwzJws
m4Tun0GZieEBCROqUpbuW+6QDvtR3XSzHhdGGSIteZv9cYyKhNu007okwr67c2Ea
11B7PcultOb4wj3xjqaO/ENDG+nmdUPaIKZrAwf2fEOarOaHgKwc11AHHbusbJWL
qH0fA1OyVgfvjg/WuCPP6Peg/Cpla7bDWqeGYt9vFTtekKoOMQLzJwl6oINbtBCcw
DZJpeaQpUhFm+ZOjwibZ5NGPBRStuYncp5xJ
-----END CERTIFICATE REQUEST-----
```

show debugging nsm

Use this command to display debugging information.

Command Syntax

```
show debugging nsm
```

Parameters

None

Default

None

Command Mode

Execution mode and Privileged execution mode

Applicability

This command was introduced before OcNOS version 1.3.

Examples

```
#show debugging nsm
NSM debugging status:
  NSM event debugging is on
  NSM packet debugging is on
  NSM kernel debugging is on
```

show debugging vm-events

Use this command to display the vm-events debugging information

Command Syntax

```
show debugging events
```

Parameters

None

Default

None

Command Mode

Execution mode

Applicability

This command was introduced before OcNOS version 6.1.0

Examples

```
#show debugging vm-events#
```

show logging cli

Use this command to display command history for all users.

Command Syntax

```
show logging cli ((logfile LOGFILENAME)|) (match-pattern WORD |)
show logging cli last <1-9999>
show logging logfile list
```

Parameters

LOGFILENAME

Name of a saved command history log file. The default path is `/var/log/messages`, but you can specify a full path to override the default.

WORD

Display only lines with this search pattern.

<1-9999>

Number of lines to display from the end of the command history.

logfile list

Display a list of command history files.

Default

LOGFILENAME Name of a saved command history log file. The default path is `/var/log/messages`, but you can specify a full path to override the default.

Command Mode

Execution mode

Applicability

This command was introduced before OcNOS version 1.3.

Example

```
#sh logging cli
2017 Mar 01 16:30:59 : : User root@/dev/pts/1 : CLI : 'exit'
2017 Mar 01 16:31:06 : : User root@/dev/pts/1 : CLI : 'sh logging logfile list'
#sh logging cli logfile ipi
2017 Mar 01 16:30:59 : : User root@/dev/pts/1 : CLI : 'exit'
2017 Mar 01 16:31:06 : : User root@/dev/pts/1 : CLI : 'sh logging logfile list'
#sh logging cli match-pattern root
2017 Mar 01 16:30:59 : : User root@/dev/pts/1 : CLI : 'exit'
2017 Mar 01 16:31:06 : : User root@/dev/pts/1 : CLI : 'sh logging logfile list'
#sh logging cli logfile ipi match-pattern root
2017 Mar 01 16:30:59 : : User root@/dev/pts/1 : CLI : 'exit'
2017 Mar 01 16:31:06 : : User root@/dev/pts/1 : CLI : 'sh logging logfile list'
#show logging cli last 2
2017 Mar 1 16:34:26.302 : : User root@/dev/pts/1 : CLI : 'sh logging info'
2017 Mar 1 16:34:37.317 : : User root@/dev/pts/1 : CLI : 'sh logging cli last 2'
#show logging logfile list
file1
file2
```

show nsm client

Use this command to display NSM client information including the services requested by the protocols, statistics and the connection time

Command Syntax

```
show nsm client
```

Parameters

None

Default

None

Command Mode

Privileged execution mode

Applicability

This command was introduced before OcNOS version 1.3.

Examples

```
#show nsm client
NSM client ID: 1
NSM client ID: 19
  IMI, socket 23
    Service: Interface Service, Router ID Service, VRF Service
    Message received 1, sent 58
    Connection time: Thu Jul 22 11:03:12 2010
    Last message read: Service Request
    Last message write: Link Up
NSM client ID: 25
  ONMD, socket 24
    Service: Interface Service, Bridge service, VLAN service
    Message received 2, sent 74
    Connection time: Thu Jul 22 11:03:15 2010
    Last message read: OAM LLDP msg
    Last message write: Link Up
#
```

show process

Use this command to display the OcNOS daemon processes that are running.

Command Syntax

```
show process
```

Parameters

None

Command Mode

Execution mode

Applicability

This command was introduced before OcNOS version 1.3.

Examples

```
#show process
PID NAME          TIME      FD
 1 nsm             00:56:29  7
 2 ripd            00:56:29 11
 3 ripngd         00:56:29 12
 4 ospfd          00:56:29  9
 5 ospf6d         00:56:29 10
 6 bgpd           00:56:29 14
 9 isisd          00:56:29  8
#
```

[Table 81](#) explains the output fields.

Table 81. show process fields

Entry	Description
PID Name	Process identifier name.
TIME	(S)—Number of system and user CPU seconds that the process has used. (None, D, and E)—Total amount of time that the command has been running.
FD	The Flexible Data-Rates (FD) of the interface.

show running-config

Use this command to show the running system status and configuration.

Command Syntax

```
show running-config
show running-config full
```

Parameters

full

Display the full configuration information.

Command Mode

Privileged execution mode and Configure mode

Applicability

This command was introduced before OcNOS version 1.3.

Examples

```
#show running-config
no service password-encryption
!
no service dhcp
ip domain-lookup
!
mpls propagate-ttl
!
vrrp vmac enable
spanning-tree mode provider-rstp
no data-center-bridging enable
!
interface lo
 ip address 127.0.0.1/8
 ipv6 address ::1/128
 no shutdown
!
interface eth0
 ip address 10.1.2.173/24
 no shutdown
!
interface eth1
 shutdown
!
line con 0
 login
!
end
(config)#
```

show running-config switch

Use this command to display the running system switch configuration.

Command Syntax

```
show running-config switch bridge
show running-config switch dot1x
show running-config switch lacp
show running-config switch ptp
show running-config switch radius-server
show running-config switch spanning-tree
show running-config switch synce
show running-config switch vlan
```

Parameters

bridge

Display Bridge group information.

dot1x

Display 802.1x port-based authentication information.

lacp

Display Link Aggregation Control Protocol (LACP) information.

ptp

Display Precision time Protocol (PTP)

radius-server

Display **RADIUS**¹ server information.

stp

Display Spanning Tree Protocol (STP) information.

synce

Display synce information.

vlan

Display values associated with a single VLAN.

Default

None

Command Mode

Privileged execution mode, configure mode, router-map mode

Applicability

This command was introduced before OcNOS version 1.3.

¹Remote Authentication Dial-In User Service

Example

```
(config)#show running-config switch stp
!  
bridge 6 ageing-time 45  
bridge 6 priority 4096  
bridge 6 max-age 7
```

show startup-config

Use this command to display the startup configuration.

Command Syntax

```
show startup-config
```

Parameters

None

Default

None

Command Mode

Privileged execution mode

Applicability

This command was introduced before OcNOS version 1.3.

Examples

```
#show startup-config
! 2001/04/21 11:38:52
!
hostname ripd
password zebra
log stdout
!
debug rip events
debug rip packet
!
interface lo
!
interface eth0
 ip rip send version 1 2
 ip rip receive version 1 2
!
interface eth1
 ip rip send version 1 2
 ip rip receive version 1 2
!
router rip
 redistribute connected
 network 10.10.10.0/24
 network 10.10.11.0/24
!
line vty
 exec-timeout 0 0
```

show tcp

Use this command to display the Transmission Control Protocol (TCP) connection details.

Command Syntax

```
show tcp
```

Parameters

None

Command Mode

Execution mode and Privileged execution mode

Applicability

This command was introduced before OcNOS version 1.3.

Examples

```
#show tcp
Proto Recv-Q Send-Q Local Address          Foreign Address        State
tcp      0      0 0.0.0.0:22             0.0.0.0:*             LISTEN
tcp      0      0 127.0.0.1:25           0.0.0.0:*             LISTEN
tcp      0      1 10.12.44.1:57740       127.0.0.1:705        CLOSE_WAIT
tcp      52     0 10.12.44.21:22         10.12.7.89:705       ESTABLISHED
tcp      85     0 10.12.44.21:57742     10.12.44.21:57738    ESTABLISHED
```

Table 82. Show tcp output

Entry	Description
Proto	Protocol – TCP
Recv-Q	Number of TCP packets in the Receive Queue.
Send-Q	Number of TCP packets in the Send-Q.
Local Address and port number	Local IP address and the port number.
Foreign Address and port number	Foreign (received) IP address and the port number.
State	Current state of TCP connections: ESTABLISHED SYN_SENT SYN_RECV FIN_WAIT1 FIN_WAIT2 TIME_WAIT CLOSE

Table 82. Show tcp output (continued)

Entry	Description
	CLOSE_WAIT LAST_ACK LISTEN CLOSING UNKNOWN

show timezone

Use this command to display the list of timezone names.

Command Syntax

```
show timezone  
(all|africa|america|antarctica|arctic|asia|atlantic|australia|brazil|canada|chile|europe|indian|mexic  
o|pacific|us)
```

Parameters

africa

Africa timezone list

all

All timezone list

I2-profile-three

L2 profile Three (default); the size of the I2 table (Mac address table) and I3 table (Host table) is almost equal

I3-profile

L3 profile

america

America timezone list

antarctica

Antarctica timezone list

asia

Asia timezone list

atlantic

Atlantic timezone list

australia

Australia timezone list

brazil

Brazil timezone list

canada

Canada timezone list

chile

Chile timezone list

europe

Europe timezone list

indian

Indian timezone list

mexico

Mexico timezone list

pacific

Pacific timezone list

us

US timezone list

Default

None

Command Mode

Execution mode and Privileged execution mode

Applicability

This command was introduced before OcNOS version 1.3.

Examples

```
#show timezone asia
Asia:
Kuwait
Samarkand
Novosibirsk
Hebron
Singapore
Dushanbe
Rangoon
Riyadh
Thimphu
Shanghai
Phnom_Penh
Taipei
Qyzylorda
Ho_Chi_Minh
Urumqi
Chita
Khandyga
Nicosia
Jerusalem
Ashkhabad
Gaza
Tel_Aviv
Baghdad
Anadyr
Tehran
Ashgabat
Saigon
Damascus
Sakhalin
Yekaterinburg
Baku
Bangkok
Kashgar
Macao
Seoul
Jakarta
Aden
Katmandu
Amman
Ujung_Pandang
Kuching
Hong_Kong
Ulan_Bator
Dhaka
```

Macau
Omsk
Vientiane
Pyongyang
Ust-Nera
Manila
Srednekolymsk
Tbilisi
Kamchatka
Magadan
Istanbul
Chongqing
Jayapura
Yerevan
Makassar
Colombo
Karachi
Hovd
Novokuznetsk
Krasnoyarsk
Irkutsk
Kabul
Kolkata
Dacca
Brunei
Calcutta
Kathmandu
Bishkek
Qatar
Tashkent
Aqtau
Oral
Kuala_Lumpur
Pontianak
Harbin
Aqtobe
Bahrain
Muscat
Vladivostok
Dubai
Tokyo
Chungking
Almaty
Choibalsan
Thimbu
Beirut
Dili
Yakutsk
Ulaanbaatar

show users

Use this command to display information about current users.

Command Syntax

```
show users
```

Parameters

None

Command Mode

Execution mode and Privileged execution mode

Applicability

This command was introduced before OcNOS version 1.3.

Example

```
#show users
Current user      : (*). Lock acquired by user : (#).
CLI user         : [C]. Netconf users       : [N].
Location : Applicable to CLI users.
Session  : Applicable to NETCONF users.
  Line   User      Idle      Location/Session   PID   TYPE      Role
(*) 130 vty 0 [C]root 00:00:36 pts/0      20872 Local    network-admin
(#)  NA    [N]root  NA          1        NA      NA      network-admin
     NA    [N]root  NA          2        NA      NA      network-admin
131 vty 1 [C]joyce 00:00:26 pts/1      17593 Remote   network-admin
```

[Table 83](#) explains the output fields.

Table 83. show users fields

Entry	Description
Current users	
CLI user	
Location	
Session	
Lock acquired by user	
Netconf users	
Line	
User	User name.
Idle	How long the user has been idle.
Location/Session	

Table 83. show users fields (continued)

Entry	Description
PID	Process identifier name.
Type	
Role	

show version

Use this command to display OcNOS version information.

Command Syntax

```
show version
```

Parameters

None

Default

None

Command Mode

Execution mode and Privileged execution mode

Applicability

This command was introduced before OcNOS version 1.3.

Examples

```
#show version
Software version: EC_AS5812-54X--1.3.4.268-DC_MPLS_ZEBM-S0-P0 09/27/2018 13:44:22
Copyright (C) 2018 Coriant. All rights reserved
Software Product: , Version: 1.3.4.268
Hardware Model: Edgecore 5812-54X-O-AC-F
Software Feature Code: DC-MPLS-ZEBM
System Configuration Code: S0
Package Configuration Code: P0
Software Baseline Version: 1.3.4.208
Installation Information:
Image Filename: EC_AS5812_54X--1.3.4.268-DC_MPLS_ZEBM-S0-P0-installer
Install method: http
ONIE SysInfo: x86_64-accton_as5812_54x-r0
#
```

Table 84. Show version output

Entry	Description
Software version	The software version including hardware device name and date.
Software Product	Product name and version.
Hardware Model	Hardware platform.
Software Feature Code	SKU that specifies the capabilities of this version of the software.
System Configuration Code	System configuration number.
Package Configuration Code	ONIE package installer versions.

Table 84. Show version output (continued)

Entry	Description
Software Baseline Version	Version from which this release branch is created.
Installation Information	Information about the installation.
Image Filename	The file name of the installed image.
Install method	The type of server (or USB stick) from which the software was installed.
ONIE SysInfo	ONIE version.

sys-reload

Use this command to cold restart the device.

Note: This command is an alias for the [reload \(page 1410\)](#) command.

Command Syntax

```
sys-reload
```

Parameters

None

Default

None

Command Mode

Execution mode

Applicability

This command was introduced in OcNOS version 1.3.7.

Examples

```
>sys-reload
The system has unsaved changes.
Would you like to save them now? (y/n): y
Building Configuration...
[OK]
Are you sure you would like to reset the system? (y/n): n
```

sys-shutdown

Use this command to shut down the device gracefully. After giving this command, you can remove the device power cable.



Note: Some of the switch hardware doesn't support system shutdown. On such devices this command will make the switch go for a reboot.

Command Syntax

```
sys-shutdown
```

Parameters

None

Default

None

Command Mode

Execution mode

Applicability

This command was introduced in OcNOS version 1.3.7.

Examples

```
>sys-shutdown
The system has unsaved changes.
Would you like to save them now? (y/n): y
Building Configuration...
[OK]
Are you sure you would like to shutdown the system? (y/n): y
For both of these prompts, you must specify whether to save or discard the changes.
For the unsaved changes prompt:
Would you like to save them now?
```

terminal width

Use this command to set the number of characters to be displayed in one line on the screen. Use the no option to unset the number of characters on the screen.



Note: If user wants to have a fixed terminal length and width, then terminal length should not be set to 0. i.e. CLI “terminal length 0” should not be used, and only non-zero length to be used.



Note: If the terminal length is set to 0, the width defaults to 80 and cannot be changed. To adjust the width, the length must first be set to a non-zero value, after which the width can be adjusted as needed.

Command Syntax

```
terminal width <24-511>  
terminal no width <24-511>
```

Parameters

<24-511>

Number of lines on screen

Default

Default width value 80 is optionally overridden by kernel.

Command Mode

Execution mode and Privileged execution mode

Applicability

This command was introduced before OcNOS version 1.3.

Examples

```
host#terminal width 120
```

terminal length

Use this command to set the number of lines displayed on the screen.

Use the `no` option to unset the number of lines on a screen.



Note: If user wants to have a fixed terminal length and width, then terminal length should not be set to 0. i.e. CLI “terminal length 0” should not be used, and only non-zero length to be used.



Note: If the terminal length is set to 0, the width defaults to 80 and cannot be changed. To adjust the width, the length must first be set to a non-zero value, after which the width can be adjusted as needed.

Command Syntax

```
terminal length <0-511>
terminal no length <0-511>
```

Parameters

<0-511>

Number of lines on screen. Specify 0 for no pausing.

Default

Default length value 24 is optionally overridden by kernel.

Command Mode

Execution mode and Privileged execution mode

Applicability

This command was introduced before OcNOS version 1.3.

Examples

```
>enable
#terminal length 0
The following example sets the terminal length to 30 lines.
#terminal length 30
```

terminal monitor

Use this command to display debugging output on the terminal for the current or active session and does not reflect in the running configuration.

Use optional parameters to display debug output for OcNOS users. Without a parameter, the command shows local user debug output. When used with a parameter, it restricts access only to the OcNOS user.

Use `no` form of the command to terminate the debug output on the terminal. The OcNOS user can use this command. In addition, the OcNOS users can cancel debug output for a specific Virtual Router (VR) or for all VRs.

Command Syntax

```
terminal monitor
terminal monitor (all|WORD|)
terminal no monitor
terminal no monitor (WORD|)
```

Parameters

WORD

In the PVR context, it specifies the VR name to include in the debugging session.

all

Includes all VRs in the debugging session when used in a PVR context.

Default

Enabled

Command Mode

Privileged execution mode

Applicability

This command was introduced before OcNOS version 1.3.

Examples

Enable debugging output on the current terminal session.

```
OcNOS>enable
OcNOS#terminal monitor
```

Disable debugging output on the current terminal session

```
OcNOS#terminal no monitor
```

terminal monitor default

Use this command to enable logging messages globally for all new user sessions, retaining the default behavior of the [terminal monitor \(page 1445\)](#) command.

Use `no` form of this command to disable logging messages globally for all new user sessions, allowing users to avoid prompt interruptions from excessive logs.



Note: Once a session is active, logging can still be controlled per session using the [terminal monitor \(page 1445\)](#) commands. The command `no terminal monitor default` will be shown in the `show running-config` output, while `terminal monitor default` will not appear.

Command Syntax

```
terminal monitor default
no terminal monitor default
```

Parameters

None

Default

Enabled

Command Mode

Configure mode

Applicability

Introduced in OcNOS version 6.6.0.

Examples

Disable Logging Output Globally

New user sessions will not display logging messages. Users can manually enable logging in the session using the [terminal monitor \(page 1445\)](#) command.

```
OcNOS#configure terminal
OcNOS(config)#no terminal monitor default
OcNOS(config)#commit
```

Enable Logging Output Globally

New user sessions will display logging messages by default.

```
OcNOS#configure terminal
OcNOS(config)#terminal monitor default
OcNOS(config)#commit
```

terminal timestamping

Use this command to display the command timestamp along with the terminal CLI prompt. Use the no option to disable it.

Command Syntax

```
terminal timestamping
terminal no timestamping
```

Parameters

None

Default

Disabled

Command Mode

Execution mode and Privileged execution mode

Applicability

This command was introduced in OcNOS version 6.6.0.

Examples

```
#terminal timestamping
[2024 Sep 13 17:24:01.442]
#<enter>
[2024 Sep 13 17:24:02.948]
#terminal no timestamping
#<enter>
#
```

terminal default timestamping

Use this command to timestamp the terminal CLI prompt by default when a new terminal session is started. Use the no option to disable it.

Command Syntax

```
terminal default timestamping
no terminal default timestamping
```

Parameters

None

Default

Disabled

Command Mode

Configure mode

Applicability

This command was introduced in OcNOS version 6.6.0.

Examples

```
#configure terminal
#terminal default timestamping
#commit

# Further terminal sessions start with the CLI prompt timestamp enabled:
[2024 Sep 13 17:31:18.330]
>enable
[2024 Sep 13 17:31:19.778]
#
```

traceroute

Use this command to trace an IPv4/v6 route to its destination.

Command Syntax

```
traceroute WORD
traceroute WORD (vrf (NAME|management)|)
traceroute ip WORD
traceroute ip WORD (vrf (NAME|management)|)
traceroute ipv6 WORD
traceroute ipv6 WORD (vrf (NAME|management)|)
```

Parameters

WORD

Destination address (in A.B.C.D format for IPv4 or X:X::X:X for IPv6) or host name.

vrf

Virtual Routing and Forwarding instance.

NAME

Virtual Routing and Forwarding name.

management

Virtual Routing and Forwarding name.

ip

IPv4 echo.

WORD

Destination address in A.B.C.D format or host name.

ipv6

IPv6 echo.

WORD

Destination address in X:X::X:X format or host name.

Default

None

Command Mode

Privileged execution mode

Applicability

This command was introduced before OcNOS version 1.3.

Examples

```
#traceroute ip 10.10.100.126 vrf management
traceroute to 10.10.100.126 (10.10.100.126), 30 hops max, 38 byte packets
 1 10.1.2.1 (10.1.2.1) 0.386 ms 0.315 ms 0.293 ms
 2 10.10.100.126 (10.10.100.126) 1.944 ms 1.497 ms 1.296 ms
#
```

watch static-mac-movement

Use this command to watch if any MAC movement is detected over static MAC entries for a time period. A notification will display if static MAC movement happens before the timer expires.

The counters can be validated with for the L2 movement queue (**Tx pkts** and **Dropped pkts** columns).

Without enabling **watch static-mac-movement**, the statistics are reflected in the **Rx EGR Port Unavail** of .

For VXLAN, **watch static-mac-movement** applies to all the MAC entries learned from the remote peer (remote dynamic or static remote), as these learned MACs are installed as static MAC entries in the hardware.

Command Syntax

```
watch static-mac-movement (<1-300>|)
```

Command Syntax

<1-300>

Timer value in seconds.

Default

By default, the timer is 10 seconds

Command Mode

Execution mode

Applicability

This command was introduced before OcNOS version 1.3.

Examples

```
#watch static-mac-movement
```

write

Use this command to write the running configuration to the file used at startup or to a specified file. This is the same as the [copy running-config startup-config \(page 1381\)](#) command.

Command Syntax

```
write
write file FILE
write memory
write WORD
```

Parameters

FILE

Write to a given path and file. If you do not give a file path, the file is added to `/root`.

memory

Write to non-volatile memory.

WORD

Write to running configuration file path.

Default

None

Command Mode

Privileged execution mode

Applicability

This command was introduced before OcNOS version 1.3.

Examples

```
This example shows writing the running configuration to the startup configuration file:
#write
Building configuration...
[OK]
This example shows writing the running configuration to a specified file:
#write file /home/test.txt
Building configuration...
[OK]
```

write terminal

Use this command to display the current configuration.

Command Syntax

```
write terminal
```

Parameters

None

Default

None

Command Mode

Privileged execution mode

Applicability

This command was introduced before OcNOS version 1.3.

Example

```
#write terminal
Current configuration:
!
hostname ripd
password zebra
log stdout
!
debug rip events
debug rip packet
!
interface lo
!
interface eth0
 ip rip send version 1 2
 ip rip receive version 1 2
!
interface eth1
 ip rip send version 1 2
 ip rip receive version 1 2
!
!
router rip
 network 10.10.10.0/24
 network 10.10.11.0/24
 redistribute connected
!
line vty
 exec-timeout 0 0
```

Multi-Line Banner Support

Overview

Multi-Line Banner support enables you to configure banner messages spanning multiple lines.

Options to Configure Multi-Banner Message

Two options to facilitate the configuration of multi-line banner messages:

- Use escape character sequences within the CLI to format the banner message with appropriate line breaks and indentation. Supported escape character sequences enable flexible alignment and multi-line message display.

The supported escape characters are:

Characters	Description
\"	double quote
\'	single quote
\`	forward quote
\\	backslash
\f	form feed
\n	newline
\r	carriage return
\t	horizontal tab
\v	vertical tab

- Specify a local file containing the banner message. The content of the file is retrieved and displayed as the banner message.

Multi-Banner Message Command

The Multi-Banner Message uses the following configuration command.

banner motd file URL

Use this optional command to set the multi-line banner messages of the day (motd) at login. To set a customized or default message of the day, use [banner motd \(page 1374\)](#) command.

Use the **no** parameter to not display a banner message at login.

**Notes:**

- Users are responsible for aligning the text of the banner. For instance, when using the "banner motd LINE" or "banner motd FILE" options, the alignment of the banner message output matches the alignment of the banner message input provided by the user.
- There is a restriction on the character count for banner messages, with a maximum limit of 1024 characters.
 - When using the FILE option to input a banner message, only the first 1024 characters from the file will be read and displayed as the banner output.
 - If the LINE option is used to input a banner message, only 1024 characters are allowed from the command line interface (CLI). If the user tries to include more than that, an error message such as "% Invalid input (Allowed length 1 - 1024):" will be displayed.
- When using the banner motd file option, consider the following:
 - The file must be available locally, and users must specify the file name along with the path during configuration.
 - Users are responsible for ensuring the correct file type, as there are no restrictions regarding the type of file allowed.
 - If the file content is empty, a notification log will be displayed to alert the user, and the default banner message will be shown.
 - If the file is removed or cannot be opened, an error log will be displayed to notify the user, and the default banner message will be shown.
- During a downgrade to a lower version that does not support the banner motd file option, if the banner motd file option is configured, the default banner message will be used.

Command Syntax

```
banner motd file URL
```

```
no banner motd
```

Parameters

file

A file input to set a custom message of the day.

URL

The file path and name containing the banner message.

Default

Disabled

Command Mode

Configure mode

Applicability

Introduced before OcNOS version 1.3.

Examples

LINE option with escape character sequence

```
#configure terminal
(config)#banner motd Welcome\n To \n OcNOS
(config)#commit
(config)#exit
```

By using a specific file

```
#configure terminal
(config)#banner motd file /home/ocnos/banner.txt
(config)#commit
(config)#exit
```

Common Management Layer Commands

This chapter is a reference for the Common Management Layer (CML) commands.

Transaction are enabled by default. You can disable the feature by using the [cmlsh transaction \(page 1480\)](#) command outside of configuration mode, but IP Infusion Inc. does `not` recommend this.

These are the steps to follow to use transactions:

- When transactions are enabled, any changes done in configure mode are stored in a separate `candidate` configuration that you can view with the [show transaction current \(page 1517\)](#) command.
- When a configuration is complete, apply the candidate configuration to the running configuration with the [commit \(page 1482\)](#) command.
- If a [commit \(page 1482\)](#) fails, no configuration is applied as the entire transaction is considered failed. You can continue to change the candidate configuration and then retry the [commit \(page 1482\)](#).
- Discard the candidate configuration with the [abort transaction \(page 1458\)](#) command.
- Check the last aborted transaction with the [show transaction last-aborted \(page 1518\)](#) command.

This chapter describes these commands:

abort transaction	1458
cancel-commit (WORD)	1459
clear cml commit-history (WORD)	1462
cml auto-config-sync	1463
cml bulk-config	1464
cml commit-history	1465
cml commit-id rollover	1467
cml config-sync check	1468
cml force-unlock config-datastore	1469
cml lock config-datastore	1470
cml logging	1472
cml netconf translation	1473
cml notification	1474
cml unlock config-datastore	1475
cmlsh cli-format	1476
cmlsh multiple-config-session	1477
cmlsh notification	1479
cmlsh transaction	1480
cmlsh transaction limit	1481
commit	1482
confirm-commit (WORD)	1484
commit dry-run	1488
commit-rollback	1489

debug cml	1491
module notification	1492
netconf translation openconfig	1494
save cml commit-history WORD	1495
show cml auto-config-sync state	1497
show cml bulk limit cpu state	1498
show cml cli-error status	1499
show cml commit-history state	1500
show cml commit-id rollover state	1501
show cml config-sync detail	1502
show cml database-dump	1503
show cml config-datastore lock status	1504
show cml notification status	1505
show cmlsh multiple-config-session status	1506
show cmlsh notification status	1507
show commit list	1507
show json/xml commit config WORD	1509
show json/xml commit diff WORD WORD	1510
show max-transaction limit	1512
show module-info	1513
show running-config notification	1515
show system restore failures	1516
show transaction current	1517
show transaction last-aborted	1518
show xml/json OBJECT_NAME	1519

abort transaction

Use this command to end a configuration session and discard all uncommitted changes.

Command Syntax

```
abort transaction
```

Parameters

None

Default

None

Command Mode

Configure mode

Applicability

This command was introduced in OcNOS version 5.0.

Examples

```
(config)#  
(config)#interface eth2  
(config-if)#ip address 10.12.3.4/24  
(config-if)#exit  
(config)#abort transaction  
(config)#exit  
#show running-config interface eth2  
!  
interface eth2  
!  
#
```

cancel-commit (WORD|)

When a <cancel-commit> operation is performed before timer expiry of a time based commit, the committed configuration will be reverted immediately.

When <cancel-commit> is performed in the same session as <commit confirmed>, a commit-id is not required, and configurations can be canceled without providing the commit-id. However, if <cancel-commit> is performed from a different session, a valid commit-id must be provided to cancel the ongoing <commit confirmed> operation.



Note: The <cancel-commit commit-id> is supported starting from OcNOS version 6.6.0. The <cancel-commit commit-id> command can be executed from different sessions as well.

Command Syntax

```
cancel-commit (WORD|)
```

Parameters

WORD

(Optional) The commit-id of the commit confirmed operation.

Default

None

Command Mode

Configure mode

Applicability

This command was introduced in OcNOS version 6.3.0 and updated in OcNOS version 6.6.0.

Example

The following example shows commit configuration changes before the timeout in a “confirmed commit” operation:

```
(config)#router ospf 1
(config-router)#router ospf 2
(config-router)#commit confirmed timeout 100 description This is a test for confirmed commit
(config-router)#confirm-commit
```

The following example shows the cancel commit configuration changes before the timer expires in a time-based commit within the same session:

```
(config)#
(config)#router ospf 1
(config-router)#router ospf 2
(config-router)#commit confirmed timeout 100 description This is Test for confirmed commit
(config-router)#cancel-commit
```

The following example shows the cancel commit configuration changes before the timer expires in a time-based commit in a different session:

Session 1

```

-----
#show commit list
S.No.      ID          User   Client      TimeStamp          Commit
Status     Description
~~~~~
~~~~~
~~~~~
#show run router ospf
!
#configure terminal
Enter configuration commands, one per line.  End with CNTL/Z.
(config)#router ospf 5
(config-router)#ospf router-id 5.5.5.5
(config-router)#commit confirmed timeout 150
(config-router)#end

#show commit list
S.No.      ID          User   Client      TimeStamp          Commit
Status     Description
~~~~~
~~~~~
~~~~~
1         1710233397092066  root   cmlsh      12-03-2024 08:49:57      Remaining Time:
148                NA

#show run router ospf
!
router ospf 5
ospf router-id 5.5.5.5
!
    
```

Session 2

```

#show commit list
S.No.      ID          User   Client      TimeStamp          Commit
Status     Description
~~~~~
~~~~~
~~~~~
1         1710233397092066  root   cmlsh      12-03-2024 08:49:57      Remaining Time:
24                NA

#show run router ospf
!
router ospf 5
ospf router-id 5.5.5.5
!
#configure terminal
Enter configuration commands, one per line.  End with CNTL/Z.
(config)#cancel-commit
%% Error: no pending commit in this session. To cancel-commit of another session, please provide a
commit-id
(config)#confirm-commit
%% Error: no pending commit in this session. To confirm-commit of another session, please provide a
commit-id
(config)#cancel-commit 1710233397092066
(config)#
(config)#end

#show commit list
S.No.      ID          User   Client      TimeStamp          Commit
Status     Description
~~~~~
~~~~~
~~~~~
    
```

```
~~~~~
```

```
#show run router ospf  
!  
#
```

clear cml commit-history (WORD|)

Use this command to delete any specific entry mentioned by commit ID or to delete entire list entries.



Notes:

- To use the commit-rollback operation, the **cml commit-history** operation must be enabled, and note that commit-rollback cannot be used for deleted entries.
- While the commit confirmation is in progress, the commit entries cannot be deleted using this command.

Command Syntax

```
clear cml commit-history (WORD|)
```

Parameters

Word

commit ID of the recorded commit operations into commit-history list

Default

When no parameter is provided, the commit history is deleted by default. If you specify the 'Word' parameter, it will delete the specific commit record.

Command Mode

Execution mode

Applicability

This command is introduced in OcNOS version 6.4.1.

Example

Example for clear commit using Commit History ID:

```
#show commit list

S.No.      ID          User  Client      TimeStamp      Commit
Status     Description
~~~~~
1  1684486018411866  ocnos  cmlsh  19-05-2023
08:46:58      Confirmed      NA
2  1684486037040268  ocnos  cmlsh  19-05-2023 08:47:17      Confirmed

#clear cml commit-history 1684486018411866
#show commit list

S.No.      ID          User  Client      TimeStamp      Commit
Status     Description
~~~~~
1  1684486037040268  ocnos  cmlsh  19-05-2023
08:47:17      Confirmed      NA
```

cml auto-config-sync

Use this command to enable or disable the CML auto configure synchronization after each 'commit'.

Command Syntax

```
cml auto-config-sync (disable|enable)
```

Parameters

enable

Enable auto configure synchronization.

disable

Disable auto configure synchronization.

Default

Enable

Config Mode

Execution mode

Applicability

This command was introduced in OcNOS version 5.1

Example

```
OcNOS#cml auto-config-sync disable
```

cml bulk-config

Use this command to avoid CPU spikes when bulk-config commit throttling occurs.

If disabled, a warning: message appears:

```
Applying bulk configuration, performance may be impacted by high CPU usage.  
Consider using 'cml bulk-config limit cpu enable' to limit CPU usage
```

Command Syntax

```
cml bulk-config limit cpu (disable|enable)
```

Parameters

limit

limit CPU usage

disable

Disable CPU limiter

enable

Enable CPU limiter.

Default

Disable

Config Mode

Execution mode

Applicability

This command was introduced in OcNOS version 6.4.

Example

```
OCNOS#cml bulk-config limit cpu enable
```

cml commit-history

Use this command to enable or disable confirmed commit operation (commit-history operation). To verify the state of the operation, use the command `show cml commit-history state`.



Notes:

- By default, cml commit-history operation is enabled.
- After disabling the cml commit-history operation, confirmed commit CLIs cannot be used, rendering the [confirm-commit \(WORD\)\] \(page 1484\)](#), and [cancel-commit \(WORD\)\] \(page 1459\)](#) operations unavailable.

Command Syntax

```
cml commit-history (enable | disable)
```

Parameters

enable

Enables commit confirmed and commit rollback operations

disable

Disables commit confirmed and commit rollback operations

Default

By default, commit confirmed and commit rollback operations are enabled.

Command Mode

Configure mode

Applicability

This command is introduced in OcNOS version 6.4.1 and updated the Command Mode to Configuration mode in OcNOS version 6.6.0 .

Examples

Example for disabling Commit History:

```
OcNOS#configure terminal
Enter configuration commands, one per line. End with CNTL/Z.
OcNOS(config)#cml commit-history disable
OcNOS(config)#commit
```

Example for verifying Commit History when commit-history is disabled:

```
OcNOS#show run commit-history
!
cml commit-history disable
!
OcNOS#
OcNOS#show xml run netconf-server
```



```
<netconf-server xmlns="http://www.ipinfusion.com/yang/ocnos/ipi-management-server">
.
.
  <commit-history>
    <config>
      <disable-commit-history></disable-commit-history>
    </config>
  </commit-history>
OcNOS#
OcNOS#show cml commit-history state
cml commit-history feature is disabled
```

Example for enabling Commit History:

```
OcNOS#configure terminal
Enter configuration commands, one per line. End with CNTL/Z.
OcNOS(config)#cml commit-history enable
OcNOS(config)#commit
```

Example for verifying Commit History when the commit-history is enabled, either by default or explicitly, it will not be displayed in the show run or show xml commands.

```
OcNOS#show run commit-history
!
OcNOS#
OcNOS#
OcNOS#show xml run netconf-server
=== NO config for commit-history =====
OcNOS#
OcNOS#show cml commit-history state
cml commit-history feature is enabled
OcNOS#
```

cml commit-id rollover

Use this command to enable or disable commit entry rollover when the maximum count of 50 commit entries is reached. When enabled, older commit entries will be automatically deleted from the commit history list to record new entries. When disabled and list contains 50 entries, commit confirmed operation is not allowed.

To verify the state of the operation, use command `show cml commit-id rollover state`.



Notes:

- By default, cml commit-id rollover operation is enabled.
- The cml commit-history operation must be enabled to use this operation.
- The commit-rollback operation can not be used for deleted entry.
- When this operation is disabled and the number of commit entries reaches the maximum count, the addition of commit records to the commit history list will be stopped.
- If this operation is disabled and the list contains 50 entries, the commit-confirmed operation cannot be performed. However, a normal commit operation is allowed even with 50 entries in the list.

Command Syntax

```
cml commit-id rollover (enable | disable)
```

Parameters

enable

Enables commit ID rollover

disable

Disables commit ID rollover

Default

By default, commit ID rollover is enabled.

Command Mode

Execution mode

Applicability

This command is introduced in OcNOS version 6.4.1.

Example

Example for verifying commit ID rollover state:

```
#show cml commit-id rollover state  
cml commit-id rollover feature is enabled
```

cml config-sync check

Use this command to manually check the configuration and create the temporary database which will help to find dbsync issues.

Command Syntax

```
cml config-sync check
```

Parameters

None

Default

None

Config Mode

Execution mode

Applicability

This command was introduced in OcNOS version 5.1.

Example

```
OcNOS#cml config-sync check
```

cml force-unlock config-datastore

Use this command to release a configuration lock previously obtained with the [cml lock config-datastore \(page 1470\)](#) command by a `different user`.

This command is available only to users with the `network-admin` role.

A notification message is sent to the lock holder when forced out.

Command Syntax

```
cml force-unlock config-datastore (running|startup|candidate) (<0-600>|)
```

Parameters

<0-600>

Timeout interval to force out lock acquired by another user session. Zero (0) is immediate and is the default.

running

Release the lock on the running datastore.

startup

Release the lock on the startup datastore.

candidate

Release the lock on the candidate datastore.

Default

The default timeout is zero (0) which is immediate.

Command Mode

Execution mode

Applicability

This command was introduced in OcNOS version 5.1.

Example

```
#cml force-unlock config-datastore running
```

cml lock config-datastore

Use this command to lock the entire configuration datastore of a device. Such locks are intended to be short-lived and allow you to make a change without fear of interaction with other users.

When the lock is acquired, the server prevents any changes to the locked resource other than those requested by this session.

The duration of the lock is defined as beginning when the lock is acquired and lasting until either the lock is released or the user session closes. The session closure can be explicitly performed by the user, or implicitly performed by the server based on criteria such as failure of the underlying transport, simple inactivity timeout, or detection of abusive behavior on the part of the client.

A lock will not be granted if any of the following conditions is true:

- A lock is already held by any user session or another entity.
- The target configuration is candidate, it has already been modified, and these changes have not been committed or rolled back.
- The target configuration is running, and another user session has an ongoing confirmed commit.

Command Syntax

```
cml lock config-datastore (running|startup|candidate)
```

Parameters

running

Lock on this datastore will not allow other sessions to perform operations with the target as running like commit, copy candidate to running and so on.

startup

Lock on this datastore will not allow other sessions to perform operations like copy-config and delete-config with the target startup

candidate

Lock on this datastore will not allow other sessions to perform operations with the target as candidate like edit-config, copy file candidate and so on. (Not supported in OcNOS version 5.1.)

Default

All three datastores are in the unlocked state.

Command Mode

Execution mode

Applicability

This command was introduced in OcNOS version 5.1.

Example

```
#cml lock config-datastore running
```

```
#
#show users
Current user      : (*).  Lock acquired by user : (#).
CLI user         : [C].  Netconf users       : [N].
Location : Applicable to CLI users.
Session  : Applicable to NETCONF users.
```

	Line	User	Idle	Location/Session	PID	TYPE	Role
(#) (*)	130 vty 0	[C]ocnos	0d00h00m	pts/0	10732	Local	network-admin

cml logging

Use this command to enable or disable CML logging. The logging level and should also be configured.

Command Syntax

```
cml logging (enable | disable)
```

Parameters

enable

Enable CML logging

disable

Disable CML logging

Default

By default CML Logging is enabled.

Command Mode

Configure mode

Applicability

This command was introduced in OcNOS version 5.0.

Example

```
(config)#cml logging disable
```

cml netconf translation

Use this command to enable or disable NetConf support for OpenConfig-based YANG translation. This allows OcNOS to handle OpenConfig YANG files in its NetConf server.

Command Syntax

```
cml netconf translation (disable|openconfig)
```

Parameters

openconfig

Translate NetConf to YANG

disable

Do not translate NetConf to YANG

Default

By default NetConf-to-YANG translation is disabled.

Command Mode

Execution mode

Applicability

This command was introduced in OcNOS version 2.0

```
#cml netconf translation openconfig
```

cml notification

Use this command to enable or disable notification for a given CML client.

Command Syntax

```
cml notification (enable|disable) (netconf|snmp|cmlsh|all)
```

Parameters

disable

Disable notification subscription

enable

Enable notification subscription

all

All CML clients

cmlsh

CML client CMLSH

netconf

CML client NETCONF

snmp

CML client SNMP

Default

By default, notification is enabled for all CML clients.

Command Mode

Execution mode

Applicability

This command was introduced in OcNOS version 6.0.0.

Example

To enable notification for NETCONF client:

```
#cml notification enable netconf
```

To disable notification for NETCONF client:

```
#cml notification disable netconf
```

cml unlock config-datastore

Use this command to release a configuration lock previously obtained with the [cml lock config-datastore \(page 1470\)](#) command.

An unlock operation will not succeed if either of the following conditions is true:

- The specified lock is not currently active.
- The session calling this command is not the same session that obtained the lock.

Command Syntax

```
cml unlock config-datastore (running|startup|candidate)
```

Parameters

running

Release the lock on the running datastore.

startup

Release the lock on the startup datastore.

candidate

Release the lock on the candidate datastore.

Default

None

Command Mode

Execution mode

Applicability

This command was introduced in OcNOS version 5.1.

Example

```
#cml unlock config-datastore running
#
#show users
Current user      : (*). Lock acquired by user : (#).
CLI user         : [C]. Netconf users       : [N].
Location : Applicable to CLI users.
Session  : Applicable to NETCONF users.

      Line      User      Idle      Location/Session  PID      TYPE      Role
(*) 130 vty 0   [C]ocnos   0d00h00m   pts/0           10732   Local   network-
admin

#
```

cmlsh cli-format

Use this command to display command strings in CLI error messages. By default, OcNOS displays error messages with Xpaths (path notation for navigating through the hierarchical structure of an XML document) which is not very clear for users.

Command Syntax

```
cmlsh cli-format (enable | disable)
```

Parameters

enable

Display command strings in CLI error messages.

disable

Display Xpaths in CLI error messages.

Default

Display Xpaths in CLI error messages

Command Mode

Execution mode

Applicability

This command was introduced in OcNOS version 6.3.0.

Example

This is the default behavior where an Xpath is displayed:

```
>en
#configure terminal
Enter configuration commands, one per line. End with CNTL/Z.
(config)#router ospf 10
(config-router)#area 3.3.3.3 interface xe1
(config-router)#commit
% Configuration " /ospfv2/processes/process[ospf-id='10']/areas/area[area-id='3.3.3.3']/interfaces/interface[name='xe1']/vrf-name" depends on "/ospfv2/global/config/area-interface-config-mode"
% Failed to commit .. As error(s) encountered during commit operation...
```

If you enable this feature, the Xpath is replaced with the respective command string:

```
>en
#cmlsh cli-format enable
#configure terminal
Enter configuration commands, one per line. End with CNTL/Z.
(config)#router ospf 10
(config-router)#area 3.3.3.3 interface xe1
(config-router)#commit
% Configuration " area <value-option> interface <value-option>" depends on " ospf area-interface-config-mode"
% Failed to commit .. As error(s) encountered during commit operation...
```

cmlsh multiple-config-session

Use this command to enable or disable multiple CLI sessions to enter into configuration mode simultaneously.

With this support, multiple CLI users can enter into configuration mode simultaneously and do configurations in parallel and commit into the running datastore. This is similar to NetConf multiple session support described in RFC 6241.

When multiple configuration mode sessions are disabled, only one user can enter configuration mode and it will lock the running datastore.

If any CLI session is already there in configuration mode, error will be given when user tries to enable this mode.

A datastore lock can be acquired using the [cml lock config-datastore \(page 1470\)](#) command if you want to do configuration without fear of interaction with other user sessions.

This command is available only to users with the **network-admin** role.

This configuration is retained across reboots.

Command Syntax

```
cmlsh multiple-config-session (enable|disable)
```

Parameters

enable

Enable multiple configuration mode sessions.

disable

Disable multiple configuration mode sessions.

Default

By default, multiple CLI sessions are disabled.

Command Mode

Execution mode

Applicability

This command was introduced in OcNOS version 5.1.

Example

```
#cmlsh multiple-config-session enable
#
#show cmlsh multiple-config-session status
CMLSh multiple configuration session mode : Enabled
#
```

Usage

Multiple users can enter into configuration mode simultaneously and do configurations in parallel and commit into the running datastore. Examples of when you need this feature are:

- Migrating to replace an existing device. If an existing device has a large configuration and it is only done by one person, it will take more time to configure. If multiple users can configure at same time, it will take less time.
- Troubleshooting and operating. Sometimes a single device has 2 or more links to troubleshoot. If only one user only can do configuration, it will take more time to resolve the problem.

When multiple sessions are doing parallel configurations, there is a chance that one user's configuration might conflict with another user's configuration.

If you do not lock the datastore before doing a configuration, a parallel candidate datastore can be created and will be allowed to commit to the datastore. So the datastore can change while the previous user is still having the configuration in its candidate. Now when the previous user tries to commit, if the configurations conflict, it will fail.

For example, if the previous user was adding a BGP neighbor and the BGP router itself is removed from the datastore via the parallel transaction, when this user tries to commit, it will fail. The reason is when commands are added to candidate, it only checks the running datastore at that point and allows them to be added to candidate configuration datastore. But later if the running datastore itself is changed, these configurations can be irrelevant and will cause an error on commit. So the user will have to abort the transaction.

cmlsh notification

Use this command to enable or disable notification for the current CMLSH session.

Command Syntax

```
cmlsh notification (enable|disable)
```

Parameters

disable

Disable notification subscription for current CMLSH session

enable

Enable notification subscription for current CMLSH session

Default

By default, notification is enabled for the CMLSH session.

Command Mode

Execution mode

Applicability

This command was introduced in OcNOS version 6.0.0.

Example

To enable notification for current CMLSH session:

```
#cmlsh notification enable
```

To disable notification for current CMLSH session:

```
#cmlsh notification disable
```

cmlsh transaction

Use this command to enable or disable the transaction-based command-line interface.



Note: IP Infusion Inc. recommends that you do *not* disable transactions.

Command Syntax

```
cmlsh transaction (enable | disable)
```

Parameters

enable

Enable transaction-based command-line interface

disable

Disable transaction-based command-line interface

Default

The transaction-based command-line interface is enabled by default.

Command Mode

Execution mode

Applicability

This command was introduced in OcNOS version 5.0.

Example

```
>en
#cmlsh transaction disable
% Deprecated CLI. Disabling transaction mode is not recommended
#configure terminal
Enter configuration commands, one per line. End with CNTL/Z.
(config)#router ipv6 ospf test
(config-router)#exit
(config)#show running-config router ipv6 ospf
!
router ipv6 ospf test
!
(config)#
```

cmlsh transaction limit

Use this command to set the maximum number of transactions.

To verify, give the command in exec mode.

Command Syntax

```
cml transaction limit <0-300000>
```

Parameters

<0-300000>

Maximum number of transactions with zero (0) indicating unlimited transactions.

Default

300,000 transactions

Command Mode

Configure mode

Applicability

This command was introduced in OcNOS version 5.0.

Example

```
(config)#cml transaction limit 1500
(config)#exit
#show max-transaction limit
Max-Transaction Limit is 1500
```

commit

Use this command to commit the candidate configuration to the running configuration.



Notes:

- After a successful `commit` command, you must give the [Basic Commands \(page 1372\)](#) command to save the running configuration to the startup configuration.
- Multiple configurations cannot be removed with a single `commit`. You must remove each configuration followed by a `commit`.

Optionally with “confirmed commit”, you can commit the configuration on a trial basis for a time specified in seconds. If you do not confirm within the specified time, the configuration will be reverted after the timeout.

- To revert the configuration before timeout, then give the [cancel-commit \(WORD\) \(page 1459\)](#) command.
- To retain the configuration before timeout, then give the [confirm-commit \(WORD\) \(page 1484\)](#) command.

See RFC 6241 “Confirmed Commit Capability”.



Notes:

- If a `<commit>` operation is executed without any parameters, the commit will be treated as permanent, and an explicit [confirm-commit \(WORD\) \(page 1484\)](#) operation is not necessary to confirm the commit.
- Multiple confirmed commits in the same session or different sessions are not supported. The `commit` command does not support the `<persist-id>` parameter as specified in RFC 6241.
- The `<confirm-commit>` and `<cancel-commit>` commands can be used from different sessions with the appropriate commit ID.

Command Syntax

```
commit (confirmed (timeout <1-86400>|)) (description LINE|)
```

Parameters

confirmed

(Optional) Commits the configuration on a trial basis, default time will be of 300 seconds.

<1-86400>

(Optional) Specifies the timeout value in seconds after which the configuration will be reverted if no confirmation is provided.

description LINE

(Optional) Commit description up to 64 valid characters.

Default

None

Command Mode

All configuration modes

Applicability

This command was introduced in OcNOS version 5.0, added the **confirmed** clause in OcNOS version 6.3.0, and enhanced the parameters in OcNOS version 6.6.0.

Example

```
(config)#router ospf 1
(config-router)#exit
(config)#router isis 3
(config-router)#commit
(config-router)#exit
(config)#show running-config ospf
!
router ospf 1
!
(config)#show running-config isis
!
router isis 3
!
(config)#
```

If you try to exit or end, you are prompted to commit or abort first:

```
(config)#router bgp 10
(config-router)#bgp as-local-count 34
(config-router)#exit
(config)#exit
% Un-committed transactions present. Please do commit or abort before exiting.
(config)#end
% Un-committed transactions present. Please do commit or abort before exiting.
(config)#commit
(config)#show running-config bgp
!
router bgp 10
  bgp as-local-count 34
!
(config)#
This is an example of a "confirmed commit":
(config)#router ospf 1
(config-router)#router ospf 2
(config-router)#commit confirmed timeout 100 description This is Test for confirmed commit
```

Usage

OcNOS validates dependencies when you commit. In this example, bridge 1 must exist before you can create a VLAN on it:

```
(config)#vlan database
(config-vlan)#vlan 10 bridge 1
(config-vlan)#exit
(config)#commit
```

Because of the unmet dependency, you get an error when you try to commit.

If you also create the bridge, the commit succeeds:

```
(config)#bridge 1 protocol mstp
(config)#vlan database
```

```
(config-vlan)#vlan 10 bridge 1
(config-vlan)#exit
(config)commit
```

In a single transaction, dependent configurations can be given in any order. Using the same example as before, you can create the bridge *after* the VLAN:

```
(config)#vlan database
(config-vlan)#vlan 10 bridge 1
(config-vlan)#exit
(config)#bridge 1 protocol mstp
(config)commit
```

OcNOS supports “hitless merges” and does not write to the candidate configuration if you make the same configuration in separate transactions. In this example, subinterface xe1.1 is not created the second time because it already exists:

```
(config)#interface xe1.1
(config-if)#commit
(config)#interface xe1.1
(config-if)#commit
```

OcNOS does not write to the candidate configuration if you create and delete the same entity in the same transaction. You must create the entity and delete it with separate commits.

Mode changes, action items (such as **clear interface counters**), and **show** commands are not part of a transaction and are not displayed by the [show transaction current \(page 1517\)](#) command.

confirm-commit (WORD|)

When a <confirm-commit> operation is performed before the timer expiry of a time based commit, it will stop the revert timer of the commit and the commit will be confirmed.

When the <confirm-commit> operation is performed in the same session as the <commit confirmed>, the commit-id is not required, and configurations can be confirmed without providing the commit-id as input. However, if the operation is performed from a different session, the appropriate commit-id must be provided to confirm the ongoing commit-confirmed operation.



Note: The <confirm-commit commit-id> is supported starting from OcNOS version 6.6.0. The <confirm-commit commit-id> command can be executed from different sessions as well.

Command Syntax

```
confirm-commit (WORD|)
```

Parameters

WORD

(Optional) The commit-id of the commit confirmed operation.

Default

None

Command Mode

All configuration modes

Applicability

This command was introduced in OcNOS version 6.3.0 and updated in OcNOS version 6.6.0.

Example

The following example shows commit configuration changes before the timeout in a “confirmed commit” operation:

```
(config)#router ospf 1
(config-router)#router ospf 2
(config-router)#commit confirmed timeout 100 description This is a test for confirmed commit
(config-router)#
(config-router)#confirm-commit
```

The following example shows the cancel commit configuration changes before the timer expires in a time-based commit within the same session:

```
(config)#
(config)#router ospf 1
(config-router)#router ospf 2
(config-router)#commit confirmed timeout 100 description This is Test for confirmed commit
(config-router)#
(config-router)#cancel-commit
```

The following example shows the cancel commit configuration changes before the timer expires in a time-based commit in a different session:

Session 1

```
OcNOS#show commit list
S.No.      ID              User   Client      TimeStamp      Commit
Status     Description
~~~~~
~~~~~
~~~~~
1         1710233773050496  root   cmlsh       12-03-2024
08:56:13      Confirmed                NA

OcNOS#show run router ospf
!
router ospf 6
  ospf router-id 6.6.6.6
!
router ospf 7
  ospf router-id 1.2.3.4
!
OcNOS#configure terminal
Enter configuration commands, one per line.  End with CNTL/Z.
OcNOS(config)#router ospf 8
OcNOS(config-router)#router ospf 9
OcNOS(config-router)#commit confirmed timeout 200
OcNOS(config-router)#end

OcNOS#show commit list
S.No.      ID              User   Client      TimeStamp      Commit
Status     Description
~~~~~
~~~~~
~~~~~
1         1710233773050496  root   cmlsh       12-03-2024
08:56:13      Confirmed                NA
```

```

2      1710233810390795  root   cmlsh  12-03-2024 08:56:50      Remaining Time:
198                                     NA

OcNOS#show run router ospf
!
router ospf 6
  ospf router-id 6.6.6.6
!
router ospf 7
  ospf router-id 1.2.3.4
!
router ospf 8
!
router ospf 9
!

```

Session 2

```

OcNOS#show commit list
S.No.      ID          User   Client   TimeStamp      Commit
Status     Description
~~~~~
~~~~~
~~~~~
1      1710233773050496  root   cmlsh    12-03-2024
08:56:13      Confirmed      NA
2      1710233810390795  root   cmlsh    12-03-2024 08:56:50      Remaining Time:
185                                     NA

OcNOS#show run router ospf
!
router ospf 6
  ospf router-id 6.6.6.6
!
router ospf 7
  ospf router-id 1.2.3.4
!
router ospf 8
!
router ospf 9
!
OcNOS#configure terminal
Enter configuration commands, one per line.  End with CNTL/Z.
OcNOS(config)#cancel-commit
%% Error: no pending commit in this session. To cancel-commit of another session, please provide a
commit-id
OcNOS(config)#confirm-commit
%% Error: no pending commit in this session. To confirm-commit of another session, please provide a
commit-id
OcNOS(config)#end

OcNOS#show commit list
S.No.      ID          User   Client   TimeStamp      Commit
Status     Description
~~~~~
~~~~~
~~~~~
1      1710233773050496  root   cmlsh    12-03-2024
08:56:13      Confirmed      NA
2      1710233810390795  root   cmlsh    12-03-2024 08:56:50      Remaining Time:
172                                     NA

OcNOS#show run router ospf
!
router ospf 6
  ospf router-id 6.6.6.6
!
router ospf 7

```

```

ospf router-id 1.2.3.4
!
router ospf 8
!
router ospf 9
!
OcnOS#configure terminal
Enter configuration commands, one per line. End with CNTL/Z.
OcnOS(config)#confirm-commit 1710233810390795
OcnOS(config)#
OcnOS(config)#end

```

```
OcnOS#show commit list
```

S.No.	ID	User	Client	TimeStamp	Commit
1	1710233773050496	root	cmlsh	12-03-2024	NA
2	1710233810390795	root	cmlsh	12-03-2024	NA

```
OcnOS#show run router ospf
```

```

!
router ospf 6
  ospf router-id 6.6.6.6
!
router ospf 7
  ospf router-id 1.2.3.4
!
router ospf 8
!
router ospf 9
!

```

commit dry-run

Use this command to validate the current candidate configuration without committing.

Command Syntax

```
commit dry-run
```

Parameters

None

Default

None

Command Mode

All configuration modes

Applicability

This command was introduced in OcNOS version 6.3.0.

Example

```
OcNOS(config)#commit dry-run
```

commit-rollback

Use this command to revert configurations to a previously committed stable state. This action will remove configurations made after the provided commit ID (Word).

The <commit confirmed> command applies the configuration on a trial basis for the time period specified in seconds. If the configuration is not confirmed by the user within this time, an auto roll-back will be triggered once the timer expires.

After the configurations are confirmed, if the user wishes to revert to either the normal commit operation or the confirmed commit operation, the commit rollback feature can be used.



Note: To use commit-rollback, cml commit-history must be enabled.

Command Syntax

```
commit-rollback to WORD (description LINE|)
```

Parameters

WORD

Commit ID associated with recorded commit operations stored within the commit- history list.

description LINE

[Optional] Short description about commit-rollback, maximum 64 valid characters.

Command Mode

Execution mode

Applicability

This command is introduced in OcNOS version 6.4.1.

Example

Example output for commit-rollback WORD:

```
#show commit list

S.No.      ID              User   Client      TimeStamp      Commit
Status
~~~~~  ~~~~~
1         1684542445002144  ocnos  cmlsh      20-05-2023
00:27:25          Confirmed          NA
```

Example of a Commit Rollback to the Commit List ID 1684542445002144:

```
#commit-rollback to 1684542445002144 description commit-rollback Test
#show commit list

S.No.      ID              User   Client      TimeStamp      Commit
Status
~~~~~  ~~~~~
1         1684542445002144  ocnos  cmlsh      20-05-2023
00:27:25          Confirmed          NA
```



```

1 1684542445002144 ocnos cmlsh 20-05-2023
00:27:25 Confirmed NA
2 1684542402123428 ocnos cmlsh 20-05-2023 00:28:45 Rollback to 20-05-2023
00:27:25 commit-rollback Test
    
```

Example of an automatic Commit Rollback

```

#show commit list

S.No.      ID          User  Client      TimeStamp          Commit
Status
~~~~~
~~~~~

#show run router ospf
!
#configure terminal
Enter configuration commands, one per line. End with CNTL/Z.
(config)#router ospf 5
(config-router)#router ospf 6
(config-router)#commit confirmed timeout 20 description This is to test auto rollback of config
(config-router)#end
#show commit list

S.No.      ID          User  Client      TimeStamp          Commit
Status
~~~~~
~~~~~

1 1698242643599569 root cmlsh 25-10-2023 14:04:03 Remaining Time:
17 This is to test auto rollback of config

#show run router ospf
!
router ospf 5
!
router ospf 6
!
#
Warning!!! Confirmed-commit timed out for commitid: 1698242643599569
#show commit list

S.No.      ID          User  Client      TimeStamp          Commit
Status
~~~~~
~~~~~

1 1698242643599569 root cmlsh 25-10-2023 14:04:03 Timed-out
(Reverted) This is to test auto rollback of config

#show run router ospf
!
#
    
```

debug cml

Use this command to enable or disable CML sub-module logging.

Command Syntax

```
debug cml (enable | disable) (events | engine | transaction | database | replace | smi | notification  
| all)
```

Parameters

enable

Enable debugging.

disable

Disable debugging.

events

Enable/disable events debugging

engine

Enable/disable engine debugging

transaction

Enable/disable transaction debugging

database

Enable/disable database debugging

replace

Enable/disable replace debugging

smi

Enable/disable SMI debugging

notification

Enable/disable notification debugging

all

Enable/disable all debugging

Default

By default, CML sub-module logging is disabled for all sub-modules.

Command Mode

Execution mode

Applicability

This command was introduced in OcNOS version 4.2 and the **notification** parameter added in OcNOS version 6.1.0.

Example

```
#debug cml enable transaction
```

module notification

Use this command to enable or disable notification for a given protocol at a given notification severity level.

Command Syntax

```
module PROTOCOL_NAME notification (enable|disable) (severity
(all|info|warning|minor|major|critical) |)
```

Parameters

PROTOCOL_NAME

Protocol name. Specify **a11** for all protocols.

enable

Enable notification subscription

disable

Disable notification subscription

severity

If notification is enabled, then all notifications having severity higher than or equal to this severity allowed. If notification disabled then all the notifications having severity lower than or equal to this severity not allowed.

all

Notification severity all

critical

Notification severity critical

info

Notification severity info

major

Notification severity major

minor

Notification severity minor

warning

Notification severity warning

Command Mode

Execution mode

Applicability

This command was introduced in OcNOS version 6.0.0.

Example

To enable notification for NSM for all severity levels:

```
#module nsm notification enable
```

To disable notifications for NSM for all severity levels:

```
#module nsm notification disable
```

To enable notifications for NSM for severity levels higher than or equal to major (major and critical):

```
#module nsm notification enable severity major
```

To disable notifications for NSM for severity levels lower than or equal to minor (info, warning, and minor):

```
#module nsm notification disable severity minor
```

netconf translation openconfig

Use this command to enable or disable Netconf OpenConfig translation.

Use the `no` form of this command to Netconf translation.

Command Syntax

```
netconf translation openconfig
no netconf translation openconfig
```

Parameters

openconfig

Translate NetConf to YANG

no

Disable OpenConfig translation

Default

Netconf OpenConfig translation is disabled.

Command Mode

Configure mode

Applicability

This command was introduced before OcNOS version 6.4.

Example

```
OcNOS# configure terminal
OcNOS(config)# netconf translation openconfig
OcNOS(config)# commit
```

save cml commit-history WORD

Use this command to save a specific commit entry mentioned by its commit ID.

Prerequisites

The `<cml commit-history>` functionality must be enabled for commit records to be stored in the commit history list to display the commit configuration.

Command Syntax

```
save cml commit-history WORD
```

Parameters

WORD

Specifies the commit ID of the commit entry to be saved. You can find the commit ID in the commit history list using the command `show commit list`.

Default

None

Command Mode

Execution mode

Applicability

Introduced in OcNOS version 6.5.0.

Example

The following example shows the sequence of the commands to be performed to save the commit list and view it:

```
OcNOS#show commit list
```

S.No. Status	ID	User Description	Client	TimeStamp	Commit
1 08:45:38	1703839538291276	root Confirmed	cmlsh	29-12-2023	NA
2 11:34:19	1703849659767186	root Confirmed	cmlsh	29-12-2023	NA
3 11:34:29	1703849669076279	root Confirmed	cmlsh	29-12-2023	NA

```
OcNOS#save cml commit-history
OcNOS#save cml commit-history ?
WORD Commit-id of commit entry to be saved
```

```
OcNOS#save cml commit-history 1703839538291276
OcNOS#show commit saved list
```

S.No. Status	ID	User Description	Client	TimeStamp	Commit
-----------------	----	---------------------	--------	-----------	--------

```

~~~~~ ~~~~~~ ~~~~~~ ~~~~~~ ~~~~~~ ~~~~~~ ~~~~~~ ~~~~~~ ~~~~~~ ~
~~~~~ ~~~~~~ ~~~~~~ ~~~~~~ ~~~~~~ ~~~~~~ ~~~~~~ ~~~~~~ ~~~~~~ ~
  1    1703839538291276    root    cmlsh    29-12-2023
08:45:38                    Confirmed                    NA

OcNOS#show commit list

S.No.      ID              User    Client      TimeStamp      Commit
Status     ~~~~~~ ~~~~~~ ~~~~~~ ~~~~~~ ~~~~~~ ~~~~~~ ~~~~~~ ~~~~~~ ~
~~~~~ ~~~~~~ ~~~~~~ ~~~~~~ ~~~~~~ ~~~~~~ ~~~~~~ ~~~~~~ ~~~~~~ ~
  1    1703839538291276    root    cmlsh    29-12-2023
08:45:38                    Confirmed                    NA
  2    1703849659767186    root    cmlsh    29-12-2023
11:34:19                    Confirmed                    NA
  3    1703849669076279    root    cmlsh    29-12-2023
11:34:29                    Confirmed                    NA

OcNOS#

```

show cml auto-config-sync state

Use this command to inspect the status and functionality of automatic configuration synchronization in a CML environment.

Command Syntax

```
show cml auto-config-sync state
```

Parameters

None

Default

None

Command Mode

Execution mode

Applicability

This command was introduced in OcNOS version 6.4.

Example

```
#Disable auto db sync:
OcNOS#cml auto-config-sync disable

#Configure the CLI that is causing the issue

#Do the config check manually:
OcNOS#cml config-sync check

#Compare the tables in both running and temporary databases:
sqlite3 /cfg/usr/local/etc/CML_RD.db
sqlite> select * from ipiCMLSEpifCMLSEpipv4;
cmlAutoDummy4097|name|cmlAutoDummy3073
4097|lo.management|3073
4097|lo|3073

sqlite3 /tmp/.CML_TMP_DB.db
sqlite> select * from ipiCMLSEpifCMLSEpipv4;
cmlAutoDummy4097|name|cmlAutoDummy3073
4097|lo.management|3073
4097|eth0|3073
4097|lo|3073
```

show cml bulk limit cpu state

Use this command to enable or disable CPU limitation when applying bulk configurations and should be used to prevent CPU spikes and system degradation during the apply process.

Command Syntax

```
show cml bulk limit cpu state
```

Parameters

None

Default

None

Command Mode

Execution mode

Applicability

This command was introduced in OcNOS version 6.5.1.

Example

```
OcNOS#show cml bulk ?
  limit limitation

OcNOS#show cml bulk limit ?
  cpu cpu

OcNOS#show cml bulk limit cpu ?
  state status (enabled | disabled)

OcNOS#show cml bulk limit cpu state ?
  | Output modifiers
  > Output redirection
  <cr>

OcNOS#show cml bulk limit cpu state
bulk timeout prompt config status is disabled

# show cml bulk limit cpu state
bulk timeout prompt config status is enabled
```

show cml cli-error status

Use this command to know the status of the cli-error feature.

Command Syntax

```
show cml cli-error status
```

Parameters

None

Default

None

Command Mode

Execution mode

Applicability

This command was introduced in OcNOS version 6.4.

Example

```
OcNOS#show cml cli-error status
cmlsh cli-error feature disabled
OcNOS#
OcNOS#cmlsh cli-format enable
OcNOS#show cml cli-error status
cmlsh cli-error feature enabled
```

show cml commit-history state

Use this command to verify whether the CMLSH commit confirmed and commit rollback feature is enabled or disabled.

Command Syntax

```
show cml commit-history state
```

Parameters

None

Default

None

Command Mode

Execution mode

Applicability

This command was introduced in OcNOS version 6.4.1.

Example

```
OcNOS#  
OcNOS#show cml commit-history state  
cml commit-history feature is enabled
```

show cml commit-id rollover state

Use this command to check commit-id rollover is enabled or not. If it is enabled after max commit-history count, old commit entry gets deleted and it adds new commit entry to the commit-history list.



Note: By default, cml commit-id rollover feature is enabled.

Command Syntax

```
show cml commit-id rollover state
```

Parameters

None

Default

Enabled

Command Mode

Execution mode

Applicability

This command was introduced in OcNOS version 6.4.1.

Example

```
OcNOS#show cml commit-id rollover state  
cml commit-id rollover feature is enabled
```

show cml config-sync detail

Use this command to check information on database sync issue, if there is mismatch in database and show running config, it will display information of invalid config with table name and values.

Command Syntax

```
show cml config-sync detail
```

Parameters

None

Default

None

Command Mode

Execution mode

Applicability

This command was introduced in OcNOS version 6.4.

Example

```
OcNOS#show cml config-sync detail
CREATE: it indicates that mentioned config is removed from DB but present in 'show running-config'
output
DELETE: it indicates that mentioned config is present in DB but does not exist in 'show running-
config' output
UPDATE1: it indicates incorrectly modified attribute value in DB. Attribute value needs to modify as
present in UPDATE2
UPDATE2: it indicates correct attribute value present in 'show running-config' output

Config datastore check done at 08-Jan-2024 at 15:31:13;

[Invalid Config from DB]: UPDATE1:INSERT INTO "ipiCMLSEPrange_timeCMLSEPranges_
timeCMLSEPrange_endCMLSEPrange_options_config" VALUES(135688,135687
,'1',135681,'2:53 15 sep 2023','?');

[ Running Config ]: UPDATE2:INSERT INTO "ipiCMLSEPrange_timeCMLSEPranges_
timeCMLSEPrange_endCMLSEPrange_options_config" VALUES(135688,135687
,'1',135681,'02:53 15 sep 2023','?');
```

show cml database-dump

Use this command to display information such as the status, size, creation date, and other relevant details about the specified database dump.

Command Syntax

```
show cml database-dump (WORD|) (candidate|)
```

Parameters

WORD

Refers to the specific name or identifier of the database dump you want to inspect.

candidate

Indicates that querying information about a candidate database dump.

Default

None

Command Mode

Execution mode

Applicability

This command was introduced in OcNOS version 6.4.

Example

```
Ocnos# show cml database-dump my_database_dump candidate
Database dump "my_database_dump" details:
- Name: my_database_dump
- Type: Candidate
- Status: Complete
- Size: 512 MB
- Creation Time: 2024-05-03 10:15:00
- Location: /var/cml/database_dumps/my_database_dump
```

show cml config-datastore lock status

Use this command to display the configuration datastore lock state and its holder. The identifier of the process holding the lock is shown in parenthesis.

Command Syntax

```
show cml config-datastore lock status
```

Parameters

None

Default

None

Command Mode

Privileged execution mode

Applicability

This command was introduced in OcNOS version 6.0.0.

Example

```
OcNOS#cml lock config-datastore candidate
OcNOS#show cml config-datastore lock status

Running datastore is unlocked
Candidate datastore is locked by client cmlsh(2831)
Startup datastore is unlocked
```

show cml notification status

Use this command to display notification status (enabled or disabled) for all CML clients.

Command Syntax

```
show cml notification status
```

Parameters

None

Command Mode

Execution mode

Applicability

This command was introduced in OcNOS version 6.0.0.

Example

To show notification status for all clients:

```
#show cml notification status
NETCONF notification enabled
CMLSH notification enabled
SNMP notification enabled
```

show cmlsh multiple-config-session status

Use this command to display the multiple configuration mode session setting.

Command Syntax

```
show cmlsh multiple-config-session status
```

Parameters

None

Default

None

Command Mode

Privileged execution mode

Applicability

This command was introduced in OcNOS version 5.1.

Example

```
#cmlsh multiple-config-session enable
#
#show cmlsh multiple-config-session status
CMLSh multiple configuration session mode : Enabled
#
```

show cmlsh notification status

Use this command to display the notification status (enabled or disabled) for the current CMLSH session.

Command Syntax

```
show cmlsh notification status
```

Parameters

None

Command Mode

Execution mode

Applicability

This command was introduced in OcNOS version 6.0.0.

Example

To show notification status for the CMLSH session.

```
# OcNOS#show cmlsh notification status
CMLSH notification enabled.
```

show commit list

Use this command to display a record of commit operations stored in the commit history list.



Note: For commit records to be stored in the commit history list, enable [cml commit-history \(page 1720\)](#). Otherwise, commit operations will not be stored.

Command Syntax

```
show commit list
```

Parameters

None

Command Mode

Execution mode

Applicability

This command is introduced in OcNOS version 6.4.1.

Example

Example for show commit list:

```
#show commit list
S.No.      ID          User   Client   TimeStamp      Commit
Status
~~~~~
1         1684542224876712  ocnos  cmlsh   20-05-2023
00:23:44      Confirmed          NA
```

show json/xml commit config WORD

Use this command to display the full running system configurations of the specified commit ID in JSON or XML format.

Prerequisites

The `<cml commit-history>` functionality must be enabled for commit records to be stored in the commit history list to display the commit configuration.

Command Syntax

```
show json/xml commit config WORD
```

Parameters

WORD

Specifies the commit ID of the recorded commit operations that is found in the commit-history list. You can find the commit ID in the commit history list using the command `show commit list`.

Default

None

Command Mode

Execution mode

Applicability

Introduced in OcNOS version 6.5.0.

Example

The following example shows the sequence of the commands to be performed to view the running configuration in JSON format:

```
OcNOS#show commit list

S.No.      ID          User  Client      TimeStamp      Commit
Status
Description
~~~~~
1  1703839538291276  root  cmlsh  29-12-2023
08:45:38          Confirmed          NA

OcNOS#show json commit ?
config  Full snapshot of a system configurations
diff    Difference of two different commit id

OcNOS#show json commit config ?
WORD    Commit-id of a commit record from commit histroy list

OcNOS#show json commit config
```

show json/xml commit diff WORD WORD

Use this command to display configuration changes from the 1st commit operation to the 2nd commit operation.

Prerequisites

The `<cml commit-history>` functionality must be enabled for commit records to be stored in the commit history list to display the commit configuration.

Command Syntax

```
show json/xml commit diff WORD WORD
```

Parameters

WORD

Specifies the starting commit ID from which you want to see the difference in recorded commit operations. You can find the commit ID in the commit history list using the command `show commit list`.

WORD

Specifies the starting commit ID to which you want to see the difference in recorded commit operations. You can find the commit ID in the commit history list using the command `show commit list`.

Default

None

Command Mode

Execution mode

Applicability

Introduced in OcNOS version 6.5.0.

Example

The following example shows the sequence of the commands to be performed to view difference between the commits in JSON format:

```
OcNOS#show commit list
```

S.No.	ID	User	Client	TimeStamp	Commit
1	1703839538291276	root	cmlsh	29-12-2023	
08:45:38		Confirmed		NA	
2	1703849659767186	root	cmlsh	29-12-2023	
11:34:19		Confirmed		NA	
3	1703849669076279	root	cmlsh	29-12-2023	
11:34:29		Confirmed		NA	

```
OcNOS#show json commit diff 1703849659767186 1703849669076279
@@ -153,6 +153,14 @@
```

```
        "vrf-name":"default",
        "router-id":"2.2.2.2"
    }
+   },
+   {
+       "ospf-id":"3",
+       "config":{
+           "ospf-id":"3",
+           "vrf-name":"default",
+           "router-id":"3.3.3.3"
+       }
+   }
    ]
}
OcNOS#
```

show max-transaction limit

Use this command to display the maximum number of transactions.

Command Syntax

```
show max-transaction limit
```

Parameters

None

Default

None

Command Mode

Execution mode

Applicability

This command was introduced in OcNOS version 5.0.

Example

```
#show max-transaction limit  
Max-Transaction Limit is 30000
```

show module-info

Use this command to display module's config and state configuration for any top-level object in the data model. This command can be used to display module configuration in XML or JSON format. This command is equivalent to a NETCONF GET operation. `show module-info OBJECT_NAME format (xml|json)`

Command Syntax

```
show module-info OBJECT_NAME format (xml|json)
```

Parameters

OBJECT_NAME

Name of the object, such as ISIS or OSPF

xml

XML output format

json

JSON output format

Command Mode

All modes

Applicability

This command was introduced in OcNOS version 6.0.0.

Example

To display the user-session module's config and state configuration in XML format:

```
#show module-info user-session format xml
<user-session xmlns="http://www.ipinfusion.com/yang/ocnos/ipi-user-session-management">
  <sessions>
    <session>
      <id>pts/0</id>
      <state>
        <id>pts/0</id>
        <user-role>network-admin</user-role>
        <type>Local</type>
        <process-identifier>1099</process-identifier>
        <idle-time>0d00h00m</idle-time>
        <client-type>CLI</client-type>
        <user-name>root</user-name>
        <line>130 vty 0</line>
      </state>
    </session>
  </sessions>
</user-session>
```

To display the user-session module's config and state configuration in JSON format:

```
#show module-info user-session format json
{
  "user-session":{
    "sessions":{
```



```
"session":[
  {
    "id":"pts/0",
    "state":{
      "id":"pts/0",
      "user-role":"network-admin",
      "type":"Local",
      "process-identifier":"1099",
      "idle-time":"0d00h00m",
      "client-type":"CLI",
      "user-name":"root",
      "line":"130 vty 0"
    }
  }
]
```

show running-config notification

Use this command to display the notification status (enabled or disabled) and notification severity levels.

Command Syntax

```
show running-config notification
```

Parameters

None

Command Mode

Execution mode

Applicability

This command was introduced in OcNOS version 6.0.0.

Example

To display the notification status and notification severity levels.

```
#show running-config notification
!  
module nsm notification enable severity major  
!
```

show system restore failures

Use this command to display configuration restoration status after save reload device.

Command Syntax

```
show system restore failures
```

Parameters

None

Command Mode

Execution mode

Applicability

This command was introduced in OcNOS version 5.1.

Example

Configuration restoration successful status information after save reload device:

```
#show system restore failures
Configuration restore from DB is completed.
Total no. of failed configuration objects = 0
```

Configuration restoration failure status information after save reload device:

```
#show system restore failures
Configuration restore from DB is completed.
Total no. of failed configuration objects = 1.

Failed Protocols information :
Protocol Name=ipi-interface, Protocol Id=3 :
Failed configuration object information :
Total no. of failed configuration objects = 1.
  Object Name = config, DN = cmlAutoDummy3074=3074,name=eth0,cmlAutoDummy3073=3073 :
  Error Information :
    Total no. of configuration errors = 1.
    ErrorCode = -16946, ErrorMessage = % No such VRF, ErrorXpath = /interfaces/interface
[name='eth0']/config.
```

show transaction current

Use this command to display the current transaction.

Mode changes, action items (such as `clear interface counters`), and `show` commands are not part of a transaction and are not displayed by this command.

Command Syntax

```
show transaction current
```

Parameters

None

Default

None

Command Mode

Execution mode and Configure mode

Applicability

This command was introduced in OcNOS version 5.0.

Example

```
(config)#interface eth3
(config-if)#description testing
(config-if)#mtu 664
(config-if)#exit
(config)#show transaction current
interface eth3
description testing
mtu 664
```

show transaction last-aborted

Use this command to display the last aborted transaction.

Command Syntax

```
show transaction last-aborted
```

Parameters

None

Default

None

Command Mode

Execution mode

Applicability

This command was introduced in OcNOS version 5.0.

Example

```
(config)#router isis 4
(config-router)#isis wait-timer 45
(config-router)#net 11.22.33
(config-router)#exit
(config)#commit
%% Invalid NET length - /isis/isis-instance[instance='4']/config
(config)#show running-config isis
!
!
(config)#abort transaction
(config)#exit
#show transaction last-aborted
router isis 4
isis wait-timer 45
net 11.22.33
#
```

show xml/json OBJECT_NAME

Use this command to display the running or candidate or startup system configuration for any top-level object in the data model. This CLI can also be used for display full running or candidate or startup system configuration for all protocol modules. This command can be used to display running or candidate or startup system configuration in xml or json format. This command is equivalent to a NETCONF GET-CONFIG operation.

Command Syntax

```
show (xml|json) (running-config | candidate-config | startup-config) OBJECT_NAME
```

Parameters

xml

XML output format

json

JSON output format

candidate-config

Candidate system configuration

running-config

Running system configuration

startup-config

Startup system configuration

OBJECT_NAME

Name of the object, such as ISIS or OSPF

Command Mode

All modes

Applicability

This command was introduced before OcNOS version 4.2 and updated in OcNOS version 6.0.0.

Example

To display the top level objects:

```
#show xml running-config
arp                bfd                bgp                dhcp                evpn                e
vpn-mpls
interfaces         ip-global         isis               key-
chains             lacp              layer2-global
lldp               logging           neighbor-discovery network-instances
ospfv2             pcep              ping               prefixes            routemaps          r
outing
segment-routing   system-info       tacacs             time-ranges        vlan-classifier
vxlan
```

To display the ISIS running configuration in XML format:

```
#show xml running-config isis
```

```
<isis xmlns="http://www.ipinfusion.com/yang/ocnos/ipi-isis">
  <isis-instance xmlns="http://www.ipinfusion.com/yang/ocnos/ipi-isis">
    <instance>1</instance>
    <config xmlns="http://www.ipinfusion.com/yang/ocnos/ipi-isis">
      <instance>1</instance>
      <vrf-name>default</vrf-name>
    </config>
  </isis-instance>
</isis>
```

To display the logging running configuration in XML format:

```
#show xml running-config logging
<logging xmlns="http://www.ipinfusion.com/yang/ocnos/ipi-logging">
  <rsyslog>
    <vrf>default</vrf>
    <config>
      <vrf>default</vrf>
      <enable-rsyslog>rsyslog</enable-rsyslog>
    </config>
  </rsyslog>
</logging>
```

To display the logging running configuration in JSON format:

```
#show json running-config logging
{
  "logging":{
    "rsyslog":[
      {
        "vrf":"default",
        "config":{
          "vrf":"default",
          "enable-rsyslog":"rsyslog"
        }
      }
    ]
  }
}
```

To display the OSPFv2 candidate configuration in XML format:

```
#show xml candidate-config ospfv2
<ospfv2 xmlns="http://www.ipinfusion.com/yang/ocnos/ipi-ospf">
  <processes>
    <process>
      <ospf-id>1</ospf-id>
      <config>
        <ospf-id>1</ospf-id>
        <vrf-name>default</vrf-name>
      </config>
    </process>
  </processes>
</ospfv2>
```

To display the OSPFv2 candidate configuration in JSON format:

```
#show json candidate-config ospfv2
{
  "ospfv2":{
    "processes":{
      "process":[
        {
          "ospf-id":"1",
          "config":{
            "ospf-id":"1",
            "vrf-name":"default"
          }
        }
      ]
    }
  }
}
```

```
}  
  }  
    }  
      }  
        }
```

Remote Management Commands

This chapter is a reference for commands that copy these types of files:

- Start-up configuration and running configuration
- System files such as boot files, core dumps, and debug logs

Users can use these commands to copy files locally or to copy between the local device and a remote system.

Here are the techniques used in the commands of this chapter to transfer files remotely:

Table 85. File transfer techniques

Trivial File Transfer Protocol (TFTP)	No authentication or encryption; dangerous to use over the Internet, but might be acceptable in a trusted environment Address format: <code>tftp: [//server[:port]] [/path]</code>
File Transfer Protocol (FTP)	Authenticates, but does not encrypt Address format: <code>ftp: [//server] [/path]</code>
Secure copy (SCP)	Authenticates and encrypts using Secure Shell (SSH1) Address format: <code>scp: [//server] [/path]</code>
SSH File Transfer Protocol (SFTP)	Authenticates and encrypts using Secure Shell (SSH2); this is the most secure technique Address format: <code>sftp: [//server] [/path]</code>
Hyper text Transfer Protocol (HTTP)	Address format: <code>http: [//server] [/path]</code> For download of running and startup configurations

This chapter contains these commands.

copy running-config	1524
copy running-config (interactive)	1525
copy startup-config	1526
copy startup-config (interactive)	1527
copy system file	1528
copy system file (interactive)	1530
copy ftp startup-config	1532
copy scp filepath	1533
copy scp startup-config	1534
copy sftp startup-config	1535
copy tftp startup-config	1536
copy http startup-config	1537
copy ftp startup-config (interactive)	1538
copy scp startup-config (interactive)	1539
copy sftp startup-config (interactive)	1540

copy tftp startup-config (interactive)	1541
copy http startup-config (interactive)	1542
copy file startup-config	1543
load-config	1544

copy running-config

Use this command to copy the running configuration to an FTP server, an SCP server, an SFTP server, or a TFTP server .

Command Syntax

```
copy running-config (tftp TFTP-URL|ftp FTP-URL|scp SCP-URL|sftp SFTP-URL) (vrf (NAME|management)|)
```

Parameters

TFTP-URL

Destination: **tftp**: [//server[:port]] [/path]

FTP-URL

Destination: **ftp**: [//server] [/path]

SCP-URL

Destination: **scp**: [//server] [/path]

SFTP-URL

Destination: **sftp**: [//server] [/path]

vrf management

Defines the management **VRF**¹ instance.

vrf NAME

Specify the user-defined VRF instance name.

Command Mode

Privileged execution mode

Applicability

This command was introduced before OcNOS version 1.3. Removed **http** parameter in OcNOS version 6.6.0.

Example

```
#copy running-config sftp sftp://sftp.mysite.com/running_conf vrf management
```

¹Virtual Routing and Forwarding

copy running-config (interactive)

Use this command to copy the running configuration to an FTP server, an SCP server, an SFTP server, or a TFTP server.

Command Syntax

```
copy running-config (ftp|tftp|scp|sftp) (vrf (NAME|management) |)
```

Parameters

ftp

Destination: FTP server

tftp

Destination: TFTP server

scp

Destination: SCP server

sftp

Destination: SFTP server

vrf management

Defines the management **VRF**¹ instance.

vrf NAME

Specify the user-defined VRF instance name.

Command Mode

Privileged execution mode

Applicability

This command was introduced before OcNOS version 1.3. Removed `http` parameter in OcNOS version 6.6.0.

Example

```
#copy running-config sftp vrf management
```

¹Virtual Routing and Forwarding

copy startup-config

Use this command to copy the running configuration to an FTP server, an SCP server, an SFTP server, or a TFTP server .

Command Syntax

```
copy startup-config (tftp TFTP-URL|ftp FTP-URL|scp SCP-URL|sftp SFTP-URL) (vrf (NAME|management)|)
```

Parameters

TFTP-URL

Destination: **tftp**: [//server[:port]] [/path]

FTP-URL

Destination: **ftp**: [//server] [/path]

SCP-URL

Destination: **scp**: [//server] [/path]

SFTP-URL

Destination: **sftp**: [//server] [/path]

vrf management

Defines the management **VRF**¹ instance.

vrf NAME

Specify the user-defined VRF instance name.

Command Mode

Privileged execution mode

Applicability

This command was introduced before OcNOS version 1.3. Removed **http** parameter in OcNOS version 6.6.0.

Examples

```
#copy startup-config sftp sftp://sftp.mysite.com/start-up_conf vrf management
```

¹Virtual Routing and Forwarding

copy startup-config (interactive)

Use this command to copy the running configuration to an FTP server, an SCP server, an SFTP server, or a TFTP server .

Command Syntax

```
copy startup-config (ftp|tftp|scp|sftp) (vrf (NAME|management) |)
```

Parameters

ftp

Destination: FTP server

tftp

Destination: TFTP server

scp

Destination: SCP server

sftp

Destination: SFTP server

vrf management

Defines the management **VRF**¹ instance.

vrf NAME

Specify the user-defined VRF instance name.

Command Mode

Privileged execution mode

Applicability

This command was introduced before OcNOS version 1.3. Removed `http` parameter in OcNOS version 6.6.0.

Examples

```
#copy startup-config sftp vrf management
```

¹Virtual Routing and Forwarding

copy system file

Use this command to copy a system file to an FTP server, an SCP server, an SFTP server, or a TFTP server.



Note: The names of the options for the source in the first parameter refer to symbolic locations. The specific locations for Linux are noted below. The locations on a specific device can vary depending on the platform.

Command Syntax

```
copy (core|debug|log|techsupport) FILE (ftp|tftp|scp|sftp) (vrf (NAME|management) |)
```

Parameters

core

Core file storage; on Linux this refers to `/var/log/crash/cores/`

debug

Debug file storage; on Linux this refers to `/log/`

log

Log file storage; on Linux this refers to `/var/log/`

techsupport

Copy techsupport log files to remote machine

filepath

Copy device file to remote machine

FILE

Source file name

TFTP-URL

Destination: `tftp: [//server[:port]] [/path]`

FTP-URL

Destination: `ftp: [//server] [/path]`

SCP-URL

Destination: `scp: [//server] [/path]`

SFTP-URL

Destination: `sftp: [//server] [/path]`

vrf management

Defines the management **VRF**¹ instance.

vrf NAME

Specify the user-defined VRF instance name.

Command Mode

Privileged execution mode

¹Virtual Routing and Forwarding

Applicability

This command was introduced before OcNOS version 1.3. Removed `http` parameter in OcNOS version 6.6.0.

Examples

```
#copy core myFile sftp sftp://sftp.mysite.com/dst_filename vrf management

#copy techsupport tech_support_23_Feb_2001_18_27_00.tar.gz scp scp://10.12.16.17/home/satya/tech_
support_23_Feb_2001_18_27_00.tar.gz vrf management
Enter Username:root
Enter Password:
% Total % Received % Xferd Average Speed Time Time Time Current
Dload Upload Total Spent Left Speed
100 72368 0 0 0 72368 0 147k --:-- --:-- --:-- 147k
100 72368 0 0 0 72368 0 147k --:-- --:-- --:-- 147k
Copy Success
```

copy system file (interactive)

Use this command to copy a system file to an FTP server, an SCP server, an SFTP server, or a TFTP server.



Note: The names of the options for the source in the first parameter refer to symbolic locations. The specific locations for Linux are noted below. The locations on a specific device can vary depending on the platform.

Command Syntax

```
copy (core|debug|log|techsupport|filepath) FILE (tftp TFTP-URL|ftp FTP-URL|scp SCP-URL|sftp SFTP-URL)
(vrf (NAME|management) |)
```

Parameters

core

Core file storage; on Linux this refers to `/var/log/crash/cores/`

debug

Debug file storage; on Linux this refers to `/log/`

log

Log file storage; on Linux this refers to `/var/log/`

techsupport

Copy techsupport log files to remote machine

filepath

Copy device file to remote machine

FILE

Source file name

TFTP-URL

Destination: `tftp: [//server[:port]] [/path]`

FTP-URL

Destination: `ftp: [//server] [/path]`

SCP-URL

Destination: `scp: [//server] [/path]`

SFTP-URL

Destination: `sftp: [//server] [/path]`

ftp

Destination: FTP server

tftp

Destination: TFTP server

scp

Destination: SCP server

sftp

Destination: SFTP server

vrf management

Defines the management **VRF**¹ instance.

vrf NAME

Specify the user-defined VRF instance name.

Command Mode

Privileged execution mode

Applicability

This command was introduced before OcNOS version 1.3.

Examples

```
#copy log myFile sftp sftp://sftp.mysite.com/dst_filename vrf management
```

¹Virtual Routing and Forwarding

copy ftp startup-config

Use this command to copy the start up configuration from an FTP server to the local device.

Command Syntax

```
copy ftp FTP-URL startup-config (vrf (NAME|management)|)
```

Parameters

FTP-URL

Configuration source: **ftp**: [//**server**] [/**path**]

vrf management

Defines the management **VRF**¹ instance.

vrf NAME

Specify the user-defined VRF instance name.

Command Mode

Privileged execution mode

Applicability

This command was introduced before OcNOS version 1.3.

Examples

```
#copy ftp ftp://ftp.mysite.com/scr filename startup-config vrf management
```

¹Virtual Routing and Forwarding

copy scp filepath

Use this command to copy the remote system file using SCP to the local device.



Note: OcNOS has a dedicated partition called `/cfg` for storing system level configurations, OcNOS configurations and license data. This is persistent across reboots and upgrades and consists of directories `/cfg/` and `/usr/local/etc`. Copying `user/general` files under `/cfg` partition is discouraged because the size of this partition is very small and impacts normal system operations like `bootup/upgrades` and important system files copy when it doesn't have enough space. Users are recommended to use `/home` to copy the general files. Please note that the contents placed in `/home` directory are deleted upon software upgrade.

Command Syntax

```
copy scp SCP-URL (filepath FILEPATH) (vrf (NAME|management))
```

Parameters

SCP-URL

Configuration source: `scp : [//server] [/path]`

FILEPATH

Enter the local filesystem path with filename

vrf management

Defines the management **VRF**¹ instance.

vrf NAME

Specify the user-defined VRF instance name.

Command Mode

Privileged execution mode

Applicability

This command was introduced before OcNOS version 3.0.

Examples

```
#copy scp scp://10.12.65.89/root/cmlsh filepath /root/cmlsh vrf management
```

¹Virtual Routing and Forwarding

copy scp startup-config

Use this command to copy the start up configuration from a SCP server to the local device.

Command Syntax

```
copy scp SCP-URL startup-config (vrf (NAME|management)|)
```

Parameters

SCP-URL

Configuration source: **scp**: [//**server**] [/path]

vrf management

Defines the management **VRF**¹ instance.

vrf NAME

Specify the user-defined VRF instance name.

Command Mode

Privileged execution mode

Applicability

This command was introduced before OcNOS version 1.3.

Examples

```
#copy scp scp://scp.mysite.com/scr filename startup-config vrf management
```

¹Virtual Routing and Forwarding

copy sftp startup-config

Use this command to copy the start up configuration from a SFTP server to the local device.

Command Syntax

```
copy sftp SFTP-URL startup-config (vrf (NAME|management) |)
```

Parameters

SFTP-URL

Configuration source: **sftp**: [//**server**] [/**path**]

vrf management

Defines the management **VRF**¹ instance.

vrf NAME

Specify the user-defined VRF instance name.

Command Mode

Privileged execution mode

Applicability

This command was introduced before OcNOS version 1.3.

Examples

```
#copy sftp sftp://sftp.mysite.com/scr filename startup-config vrf management
```

¹Virtual Routing and Forwarding

copy tftp startup-config

Use this command to copy the start up configuration from a TFTP server to the local device.

Command Syntax

```
copy tftp TFTP-URL startup-config (vrf (NAME|management) |)
```

Parameters

TFTP-URL

Configuration source: **tftp**: [//**server**] [/**path**]

vrf management

Defines the management **VRF**¹ instance.

vrf NAME

Specify the user-defined VRF instance name.

Command Mode

Privileged execution mode

Applicability

This command was introduced before OcNOS version 1.3.

Examples

```
#copy tftp tftp://tftp.mysite.com/scr filename startup-config vrf management
```

¹Virtual Routing and Forwarding

copy http startup-config

Use this command to copy the start up configuration from an HTTP server to the local device.

Command Syntax

```
copy http HTTP-URL startup-config (vrf (NAME|management) |)
```

Parameters

HTTP-URL

Configuration source: **http**: [//**server**] [/**path**]

vrf management

Defines the management **VRF**¹ instance.

vrf NAME

Specify the user-defined VRF instance name.

Command Mode

Privileged execution mode

Applicability

This command was introduced before OcNOS version 1.3.

Examples

```
#copy http http://http.mysite.com/scr filename startup-config vrf management
```

¹Virtual Routing and Forwarding

copy ftp startup-config (interactive)

Use this command to copy the start up configuration from an FTP server to the local device.

Command Syntax

```
copy ftp startup-config (vrf (NAME|management) |)
```

Parameters

vrf management

Defines the management **VRF**¹ instance.

vrf NAME

Specify the user-defined VRF instance name.

Default

None

Command Mode

Privileged execution mode

Applicability

This command was introduced before OcNOS version 1.3.

Example

```
#copy ftp startup-config vrf management
```

¹Virtual Routing and Forwarding

copy scp startup-config (interactive)

Use this command to copy the start up configuration from a SCP server to the local device.

Command Syntax

```
copy scp startup-config (vrf (NAME|management) |)
```

Parameters

vrf management

Defines the management VRF¹ instance.

vrf NAME

Specify the user-defined VRF instance name.

Default

None

Command Mode

Privileged execution mode

Applicability

This command was introduced before OcNOS version 1.3.

Examples

```
#copy scp startup-config vrf management
```

¹Virtual Routing and Forwarding

copy sftp startup-config (interactive)

Use this command to copy the start up configuration from an SFTP server to the local device.

Command Syntax

```
copy sftp startup-config (vrf (NAME|management) |)
```

Parameters

vrf management

Defines the management **VRF**¹ instance.

vrf NAME

Specify the user-defined VRF instance name.

Default

None

Command Mode

Privileged execution mode

Applicability

This command was introduced before OcNOS version 1.3.

Examples

```
OcNOS#copy sftp startup-config vrf management
```

¹Virtual Routing and Forwarding

copy tftp startup-config (interactive)

Use this command to copy the start-up configuration from a TFTP server to the local device.

Command Syntax

```
copy tftp startup-config (vrf (NAME|management) |)
```

Parameters

vrf management

Defines the management **VRF**¹ instance.

vrf NAME

Specify the user-defined VRF instance name.

Default

None

Command Mode

Privileged execution mode

Applicability

This command was introduced before OcNOS version 1.3.

Examples

```
OcNOS#copy tftp startup-config vrf management
```

¹Virtual Routing and Forwarding

copy http startup-config (interactive)

Use this command to copy the start-up configuration from an HTTP server to the local device.

Command Syntax

```
copy http startup-config (vrf (NAME|management) |)
```

Parameters

vrf management

Defines the management VRF¹ instance.

vrf NAME

Specify the user-defined VRF instance name.

Default

None

Command Mode

Privileged execution mode

Applicability

This command was introduced before OcNOS version 1.3.

Examples

```
OcNOS#copy http startup-config vrf management
```

¹Virtual Routing and Forwarding

copy file startup-config

Use this command to copy and store a local file into the startup configuration.

Command Syntax

```
copy file FILE startup-config
```

Parameters

FILE

File name

Default

None

Command Mode

Privileged execution mode

Applicability

This command was introduced before OcNOS version 1.3.

Examples

```
OcNOS#copy file myFile startup-config
```

load-config

Use this command to copy a configuration file from either the remote or local file system and apply it to the running-config.

Command Syntax

```
load-config ((scp SCP-URL) | (filepath FILEPATH))
```

Parameters

SCP-URL

Configuration source in the format `scp: [//server] [/path]`

FILEPATH

Enter the local file system path with the filename.

Default

None

Command Mode

Privileged execution mode

Applicability

This command was introduced in OcNOS version 6.4.1.

Example

For instance, when retrieving a configuration from a remote source, the command might be used as follows:

Remote:

```
Remote#cat /home/config.txt
interface eth2
 ip address 3.3.3.5/24
```

Device:

```
OcNOS#load-config scp scp://10.12.43.155/home/config.txt
Enter Username:root
Enter Password:
Enter configuration commands, one per line. End with CNTL/Z.
Please wait. System is restoring previous saved configs..
This may take sometime. Please don't abort....
 50% [|||||]
Please wait. Starting commit operation..
This may take sometime. Please don't abort....
100% [|||||]
```

Interface Commands

This chapter is a reference for each of the interface commands.

admin-group	1548
bandwidth	1549
bandwidth-measurement static uni-available-bandwidth	1550
bandwidth-measurement static uni-residual-bandwidth	1551
bandwidth-measurement static uni-utilized-bandwidth	1552
clear hardware-discard-counters	1553
clear interface counters	1554
clear interface cpu counters	1555
clear interface fec	1556
clear ip prefix-list	1557
clear ipv6 neighbors	1558
clear ipv6 prefix-list	1559
debounce-time	1560
delay-measurement dynamic twamp	1562
delay-measurement a-bit-min-max-delay-threshold	1564
delay-measurement static	1565
delay-measurement a-bit-delay-threshold	1567
default-interface l2protocol	1567
default-interface load-interval	1569
default-interface type mtu	1569
description	1571
duplex	1572
fec	1573
flowcontrol	1575
hardware-profile portmode	1577
if-arbiter	1578
interface	1579
ip address A.B.C.D/M	1580
ip address dhcp	1581
ip forwarding	1582
ip prefix-list	1583
ip proxy-arp	1585
ip remote-address	1586
ip unnumbered	1587
ip vrf forwarding	1588
ipv6 address	1589

ipv6 forwarding	1590
ipv6 prefix-list	1591
ipv6 unnumbered	1593
link-debounce-time	1594
load interval	1595
loopback	1596
loss-measurement dynamic	1597
loss-measurement uni-link-loss	1598
mac-address	1599
monitor speed	1600
monitor queue-drops	1601
monitor speed threshold	1602
mtu	1603
multicast	1605
show flowcontrol	1606
show hardware-discard-counters	1608
show interface	1610
show interface capabilities	1613
show interface counters	1615
show interface counters drop-stats	1618
show interface counters error-stats	1621
show interface counters (indiscard-stats outdiscard-stats)	1623
show interface counters protocol	1626
show interface counters queue-drop-stats	1627
show interface counters queue-stats	1628
show interface counters rate	1630
show interface counters speed	1632
show interface counters summary	1633
show interface fec	1635
show ip forwarding	1637
show ip interface	1638
show ip prefix-list	1640
show ip route	1642
show ip route A.B.C.D/M longer-prefixes	1644
show ip vrf	1652
show ipv6 forwarding	1653
show ipv6 interface brief	1654
show ipv6 route	1656
show ipv6 prefix-list	1658
show hosts	1660

show running-config interface	1662
show running-config interface ip	1664
show running-config interface ipv6	1665
show running-config ip	1666
show running-config ipv6	1667
show running-config prefix-list	1668
shutdown	1669
speed	1670
switchport	1673
switchport allowed ethertype	1675
switchport protected	1676
transceiver	1677
tx cdr-bypass	1679
rx cdr-bypass	1680

admin-group

Use this command to create an administrative group to be used for links. Each link can be a member of one or more, or no administrative groups.

When used in the interface mode, this command adds a link between an interface and a group. The name is the name of the group previously configured. There can be multiple groups per interface. The group is created in configure mode, then interfaces are added to the group in interface mode.

Use the `no` parameter with this command to disable this command.

Command Syntax

```
admin-group NAME
no admin-group NAME
```

Parameters

Name

Name of the admin group to add.

Default

None

Command Mode

Interface mode

Applicability

This command was introduced before OcNOS version 1.3.

Example

In the following example, the `eth3` interface is added to the group `myGroup`:

```
#configure terminal
(config)#interface eth3
(config-if)#admin-group myGroup
```

bandwidth

Use this command to specify a discrete, maximum bandwidth value for the interface.

Use the `no` parameter resets the interface's bandwidth to the default value.

Command Syntax

```
bandwidth BANDWIDTH
no bandwidth
```

Parameters

BANDWIDTH

<1-999>k for 1 to 999 kilobits/s

<1-999>m for 1 to 999 megabits/s

<1-100>g for 1 to 100 gigabits/s

Default

Default bandwidth is the link speed of the interface. For **LAG**¹, default bandwidth will be collective bandwidth of its member ports. For VLAN interface, default bandwidth is 1 gigabits/sec.

Command Mode

Interface mode

Applicability

This command was introduced before OcNOS version 1.3.

Example

```
#configure terminal
(config)#interface xe4
(config-if)#bandwidth 100m
```

¹Link Aggregation Group

bandwidth-measurement static uni-available-bandwidth

Use this command to advertise the available bandwidth between two directly connected OSPF/ISIS neighbors. Use the `no` parameter with this command to unset available bandwidth on the current interface.

Command Syntax

```
bandwidth-measurement static uni-available-bandwidth BANDWIDTH
no bandwidth-measurement static uni-available-bandwidth
```

Parameters

BANDWIDTH

<0-999>k for 0 to 999 kilobits/s

<0-999>m for 0 to 999 megabits/s

<0-100>g for 0 to 100 gigabits/s

Command Mode

Interface mode

Applicability

This command was introduced in OcNOS version 5.0.

Examples

```
(config)#int eth2
(config-if)#bandwidth-measurement static uni-available-bandwidth 10k
(config-if)#commit

(config)#int eth2
(config-if)#no bandwidth-measurement static uni-available-bandwidth
(config-if)#commit
```

bandwidth-measurement static uni-residual-bandwidth

Use this command to advertise the residual bandwidth between two directly connected OSPF/ISIS neighbors. Use the `no` parameter with this command to unset residual bandwidth on the current interface.

Command Syntax

```
bandwidth-measurement static uni-residual-bandwidth BANDWIDTH
no bandwidth-measurement static uni-residual-bandwidth
```

Parameters

BANDWIDTH

<0-999>k for 0 to 999 kilobits/s

<0-999>m for 0 to 999 megabits/s

<0-100>g for 0 to 100 gigabits/s

Command Mode

Interface mode

Applicability

This command was introduced in OcNOS version 5.0.

Examples

```
(config)#interface ethernet 2
(config-if)#bandwidth-measurement static uni-residual-bandwidth 10g
(config-if)#commit

(config)#interface ethernet 2
(config-if)#no bandwidth-measurement static uni-residual-bandwidth
(config-if)#commit
```

bandwidth-measurement static uni-utilized-bandwidth

Use this command to advertise the utilized bandwidth between two directly connected OSPF/ISIS neighbors.

Use the `no` parameter with this command to unset utilized bandwidth on the current interface.

Command Syntax

```
bandwidth-measurement static uni-utilized-bandwidth BANDWIDTH
no bandwidth-measurement static uni-utilized-bandwidth
```

Parameters

BANDWIDTH

<0-999>k for 0 to 999 kilobits/s

<0-999>m for 0 to 999 megabits/s

<0-100>g for 0 to 100 gigabits/s

Command Mode

Interface mode

Applicability

This command was introduced in OcNOS version 5.0.

Examples

```
(config)#int eth2
(config-if)#bandwidth-measurement static uni-utilized-bandwidth 10m
(config-if)#commit
```

```
(config)#int eth2
(config-if)#no bandwidth-measurement static uni-utilized-bandwidth
(config-if)#commit
```

clear hardware-discard-counters

Use this command to clear device level discard counters.

Command Syntax

```
clear hardware-discard-counters
```

Parameters

None

Default

None

Command Mode

Execution mode

Applicability

The command is introduced before OcNOS version 1.3.

Examples

```
#clear hardware-discard-counters
```

clear interface counters

Use this command to clear the statistics on a specified interface or on all interfaces.



Note: This command is not supported on loopback interfaces or the out-of-band management (OOB) management interface.

Command Syntax

```
clear interface (IFNAME|) counters
```

Parameters

IFNAME

Interface name.

Command Mode

Execution mode and Privileged execution mode

Applicability

This command was introduced before OcNOS version 1.3.

Example

```
#clear interface xe0 counters
```

clear interface cpu counters

Use this command to clear the CPU queue counters.

Command Syntax

```
clear interface cpu counters
```

Parameters

None

Default

None

Command Mode

Execution mode and Privileged execution mode

Applicability

This command was introduced before OcNOS version 1.3.

Example

```
OcNOS#clear interface cpu counters
```

clear interface fec

Use this command to clear **FEC**¹ (forward error correction) statistics on a specified interface or on all interfaces.



Note: This command is not supported on loop-back interfaces or the out-of-band (OOB) management interface.

Command Syntax

```
clear interface (IFNAME|) fec
```

Parameter

IFNAME

Physical Interface name.

Default

None

Command Mode

Execution mode and Privileged execution mode

Applicability

This command was introduced before OcNOS version 1.3.

Example

```
#clear interface ce1/1 fec
```

¹FEC is a technique that detects and corrects errors during data transmission to maintain the reliability of the communication system.

clear ip prefix-list

Use this command to reset the hit count to zero in the prefix-list entries for an IPv4 interface.

Command Syntax

```
clear ip prefix-list  
clear ip prefix-list WORD  
clear ip prefix-list WORD A.B.C.D/M
```

Parameters

WORD

Name of the prefix-list.

A.B.C.D/M

IP prefix and length.

Default

None

Command Mode

Execution mode

Applicability

This command was introduced before OcNOS version 1.3.

Example

```
#clear ip prefix-list List1
```

clear ipv6 neighbors

Use this command to clear all dynamic IPv6 neighbor entries.

Command Syntax

```
clear ipv6 neighbors
```

Parameters

None

Default

None

Command Mode

Privileged execution mode

Applicability

This command was introduced before OcNOS version 1.3.

Example

```
OcNOS#clear ipv6 neighbors
```

clear ipv6 prefix-list

Use this command to reset the hit count to zero in the prefix-list entries for an IPv6 interface.

Command Syntax

```
clear ipv6 prefix-list  
clear ipv6 prefix-list WORD  
clear ipv6 prefix-list WORD X:X::X:X/M
```

Parameters

WORD

Name of the prefix-list.

X:X::X:X/M

IP prefix and length.

Default

None

Command Mode

Privileged execution mode

Applicability

This command was introduced before OcNOS version 1.3.

Example

```
OcNOS#clear ipv6 prefix-list List1
```

debounce-time

Use this command to set the debounce time for a interface.

The debounce timer avoids frequent updates (churn) to higher layer protocol during interface flapping. If the status of a link changes quickly from up to down and then back to up, the port debounce timer suppresses the link status notification. If the link transitions from up to down, but does not come back up, the port debounce timer delays the link status notification.



Notes:

- Keep the following in mind when using the debounce timer:
- Debounce is not applicable for admin down operations.
- Debounce timer is supported only for physical L2 and L3 interfaces.
- The debounce flap-count refers to the number of flaps OcNOS receives while the debounce timer is running:
 - The flap-count is only updated if the timer is still running and OcNOS receives a link status event for the interface.
 - The flap-count is reset at the subsequent start of the debounce timer.
- Protocol-specific timers such as BFD which depend on the link status should be configured to a minimum of 1.5 times the value of the debounce timer. Otherwise it could affect the protocol states if the debounce timer is still running.

Use the `no` form of this command to turn-off the debounce timer on a interface.

Command Syntax

```
debounce-time <250-5000>  
no debounce-time
```

Parameters

<250-5000>

Timer value in milliseconds.

Default

None

Command Mode

Interface mode

Applicability

This command was introduced in OcNOS version 1.3.8.

Example

```
#configure terminal
(config)#interface eth1
(config-if)#debounce-time 4000
```

delay-measurement dynamic twamp

This command will start the measurement on the interface by using the "interfaces" profile.

The user should be aware that the IP used as a reflector IP must be a directly connected IP.

In case hostname needs to be used, the user must be sure about the hostnames configured in the network.

In case the user configures the delay-measurement with a certain hostname and then the hostname entry in the DNS changes, the delay-measurement must be unconfigured and configured again for the new configuration to take effect (a clear command would not be sufficient in this situation)

Use the **no** form of this command to stop the delay measurement.

Command Syntax

```
delay-measurement dynamic twamp reflector-ip (HOSTNAME | X:X::X:X | A.B.C.D) (reflector-port <1025-65535>|) (sender-ip (HOSTNAME | X:X::X:X | A.B.C.D)|) (dscp WORD|)
no delay-measurement dynamic twamp reflector-ip (HOSTNAME | X:X::X:X | A.B.C.D)
```

Parameters

twamp

This parameter specifies the protocol to be used to do the measurement. It is the only protocol available in this implementation. The subsequent parameters in this command are specific to the protocol chosen (TWAMP).

reflector-ip

Specify the reflector ip/hostname used to send the TWAMP packets to

HOSTNAME

The hostname of the reflector

X:X::X:X

The ip address of the reflector

A.B.C.D

The ip address of the reflector

reflector-port

Specify the **UDP**¹ port of the TWAMP reflector

<1025-65535>

The reflector port value

sender-ip

Specify the IP used to send the TWAMP packets from (must be an IP configured on the current interface)

HOSTNAME

The hostname of the reflector

X:X::X:X

The ip address of the reflector

A.B.C.D

The ip address of the reflector

dscp

Specify the dscp value used during this measurement

¹User Datagram Protocol

WORD

The dscp value

Default

None

Command Mode

Interface mode

Applicability

This command was introduced in OcNOS version 5.1.

Example

```
(config)#interface xe7
(config-if)#delay-measurement dynamic twamp reflector-ip 23.1.1.2 sender-ip 23.1.1.1 dscp 24
(config-if)#commit

(config-if)#no delay-measurement dynamic twamp reflector-ip 23.1.1.2
(config-if)#commit
```

delay-measurement a-bit-min-max-delay-threshold

Use this command to advertise the minimum and maximum delay values between two directly connected IS-IS/OSPF neighbors.

The A bit is set when one or more measured values exceed a configured maximum threshold. The A bit is cleared when the measured value falls below its configured reuse threshold.

Use the `no` parameter with this command to unset `a-bit-min-max-delay-threshold` on the current interface.

Command Syntax

```
delay-measurement a-bit-min-max-delay-threshold min <1-16777215> <1-16777215> max <1-16777215> <1-16777215>
no delay-measurement a-bit-min-max-delay-threshold
```

Parameters

min

Reuse threshold

<1-16777215>

Reuse threshold value of Min-Delay in microseconds

<1-16777215>

Reuse threshold value of Max-Delay in microseconds

a-bit-threshold

Threshold values to set/clear A-bit

max

Maximum threshold

<1-16777215>

Maximum threshold value of Min-Delay in microseconds

<1-16777215>

Maximum threshold value of Max-Delay in microseconds

Default

None

Command Mode

Interface mode

Applicability

This command was introduced in OcNOS version 5.0.

Examples

```
#configure terminal
(config)#interface eth1
(config-if)#delay-measurement a-bit-min-max-delay-threshold min 11 22 max 33 44
(config-if)#no delay-measurement a-bit-min-max-delay-threshold
```

delay-measurement static

Use this command to advertise static the minimum and maximum delay values or average link delay variation or average link delay values between two directly connected IS-IS/OSPF neighbors.

Use the **no** parameter with this command to unset min-max-uni-link-delay, uni-delay-variation and uni-link-delay static values on the current interface.

Command Syntax

```
delay-measurement static (min-max-uni-link-delay <1-16777215> <1-16777215> | uni-delay-variation <0-16777215> | uni-link-delay <1-16777215>)  
no delay-measurement static (min-max-uni-link-delay | uni-delay-variation | uni-link-delay)
```

Parameters

min-max-uni-link-delay

Min/Max Unidirectional Link Delay

<1-16777215>

Minimum Unidirectional Link Delay in microseconds

<1-16777215>

Maximum Unidirectional Link Delay in microseconds

uni-delay-variation

Unidirectional Delay Variation

<0-16777215>

Value in microseconds

uni-link-delay

Unidirectional Link Delay

<1-16777215>

Value in microseconds

Default

None

Command Mode

Interface mode

Applicability

This command was introduced in OcNOS version 5.0.

Examples

```
#configure terminal  
(config)#interface eth1  
(config-if)#delay-measurement uni-delay-variation static 12  
(config-if)#no delay-measurement uni-delay-variation static  
  
#configure terminal
```

```
(config)#interface eth1
(config-if)#delay-measurement static uni-link-delay 12
(config-if)#no delay-measurement static uni-link-delay
(config-if)#delay-measurement static min-max-uni-link-delay 1 3
config-if)#no delay-measurement static min-max-uni-link-delay
```

delay-measurement a-bit-delay-threshold

Use this command to advertise average link delay between two directly connected IS-IS/OSPF neighbors. a-bit-threshold represents the Anomalous (A) bit. The A bit is set when the static value exceeds its configured maximum threshold. The A bit is cleared when the static value falls below its configured reuse threshold. Use the **no** parameter with this command to unset uni-link-delay on the current interface.

Command Syntax

```
delay-measurement a-bit-delay-threshold min <1-16777215> max <1-16777215>))  
no delay-measurement a-bit-delay-threshold
```

Parameters

min

Reuse threshold

<1-16777215>

Reuse threshold value in microseconds

max

Maximum threshold

<1-16777215>

Maximum threshold value in microseconds

Default

None

Command Mode

Interface mode

Applicability

This command was introduced in OcNOS version 5.0.

Examples

```
#configure terminal  
(config)#interface eth1  
(config-if)#delay-measurement a-bit-delay-threshold min 11 max 22  
(config-if)#no delay-measurement a-bit-delay-threshold
```

default-interface l2protocol

Use this command to configure the L2CP globally specific to protocol type. Use the **no** parameter with this command to remove this configuration.

Command Syntax

```
default-interface l2protocol (stp | lacp | dot1x | lldp | efm | elmi) (peer | tunnel | discard)
no default-interface l2protocol (stp | lacp | dot1x | lldp | efm | elmi)
```

Parameter

dot1x

Port Authentication (802.1 X).

efm

Ethernet first mile (Link OAM).

elmi

Ethernet local management interface.

lacp

Link Aggregation (LACP).

lldp

Link layer discovery protocol.

stp

Spanning Tree Protocols.

synce

Synchronous Ethernet.

discard

Discard the protocol data unit.

peer

Peer the protocol data unit.

tunnel

tunnel the protocol data.

Default

None

Command Mode

Configure mode

Applicability

This command was introduced in OcNOS version 6.6.0.

Example

```
#configure terminal
(config)# default-interface l2protocol lacp tunnel
(config)#no default-interface l2protocol lacp
```

default-interface load-interval

Use this command to configure the load interval globally for all interface types. This shall be overridden by the interface-specific configuration, see load-interval configuration on interface level.

Use the *no* parameter to un-configure the load interval globally.

Use show default-interface to verify this configuration.

Command Syntax

```
default-interface load-interval <30-300>
no default-interface load-interval
```

Parameter

<3-300>

Configure on all interfaces load period in multiples of 30 seconds

(default is 300 seconds).

Default

Disabled.

Command Mode

Configure mode

Applicability

This command was introduced in OcNOS version 6.6.0.

Example

#configure terminal

```
#configure terminal
(config)# default-interface load-interval 90
#configure terminal
(config)#no default-interface load-interval
```

default-interface type mtu

Use this command to configure the MTU globally specific to interface types.

Use the *no* to un-configure the MTU globally specific to interface.

Command Syntax

```
default-interface type (eth-routed | eth-switchport | l2-subif | l3-subif | svi | lag | mlag | bvi |
irb) mtu <64-65535>
no default-interface type (eth-routed | eth-switchport | l2-subif | l3-subif | svi | lag | mlag | bvi
| irb) mtu
```

Parameter

eth-routed

Physical L3 interface.

eth-switchport

Physical L2 interface.

irb

IRB logical Interface.

l2-subif

L2 subinterface.

l3-subif

L3 subinterface.

lag

Port-channel and static-aggregate.

mlag

Mlag Aggregate interface.

svi

VLAN interface.

<64-65535>

MTU in bytes.

Default

Disabled

Command Mode

Configure mode

Applicability

This command was introduced in OcNOS version 6.6.0.

Example

#configure terminal

```
#configure terminal
(config)# default-interface type lag mtu 9200
(config)#no default-interface type lag
```

description

Use this command to assign an description to an interface.

Use the `no` parameter to remove an interface description.

Command Syntax

```
description LINE
no description
```

Parameter

LINE

Interface description. Avoid the special characters “?”, “”, “>”, “|”, and “=” in the description. The | is allowed only for interface description CLI.

Default

None

Command Mode

Interface mode

Applicability

This command was introduced before OcNOS version 1.3.

Examples

The following example provides information about the connecting router for interface `eth1`.

```
Router#configure terminal
Router(config)#interface eth1
Router(config-if)#description Connected to Zenith's fas2/0
```

duplex

Use this command to set the duplex mode for each interface.

Use the `no` parameter to remove the duplex mode.



Note: Interface duplex setting is not supported on Management interface `eth0`.

Command Syntax

```
duplex {half|full}
no duplex
```

Parameters

half

Half-duplex mode.

full

Full-duplex mode.

Default

By default, duplex mode is full duplex.

Command Mode

Interface mode

Applicability

This command was introduced before OcNOS version 1.3.

Examples

```
#configure terminal
(config)#interface eth3
(config-if)#duplex full

(config-if)#no duplex
```

fec

Use this command to force/auto configure forward error correction (**FEC**¹) on a physical port. Use the `no` parameter to enable automatic FEC configuration provisioning based on medium.

Command Syntax

```
fec (on (c174|c191|c1108)|off|auto)
no fec
```

Parameters

on

Enables FEC.

on c174

Enables Base-R FEC if hardware supports it.

on c191

Enables RS-528 FEC if hardware supports it.

on c1108

Enables RS-108 with 64/66b 5T low latency RS FEC for fabric.

off

Disable FEC.

auto

Automatically apply FEC for the below transceiver Ethernet compliance codes.

Transceiver compliance codes can be fetched via the "show interface controller" command. Also, "fec auto" behavior is the same as no fec.

100G Active Optical Cable (AOC) or 25GAUI C2M AOC

100G Active Copper Cable (ACC) or 25GAUI C2M ACC

100G ACC or 25GAUI C2M ACC

100G AOC or 25GAUI C2M AOC

100GBASE-SR4 or 25GBASE-SR

100G AOC or 25GAUI C2M AOC

Default

By default, FEC mode is set to auto.

Command Mode

Interface mode

Applicability

Introduced before OcNOS version 4.1. Added new parameters `c174` and `c191` in OcNOS version 6.3.1 and `c1108` in OcNOS version 6.6.0.

¹FEC is a technique that detects and corrects errors during data transmission to maintain the reliability of the communication system.

Examples

```
(config)#interface eth3
(config-if)#fec on
(config-if)#fec off
(config-if)#fec auto
(config-if)#fec on c174
(config-if)#fec on c191
(config-if)#fec on c1108
```

flowcontrol

Use this command to enable or disable flow control.

Flow control enables connected Ethernet ports to control traffic rates during periods of congestion by allowing congested nodes to pause link operations at the other end. If one port experiences congestion and cannot receive any more traffic, it notifies the other port to stop sending until the condition clears. When a local device detects congestion at its end, it notifies the remote device by sending a pause frame. On receiving a pause frame, the remote device stops sending data packets, which prevents loss of data packets during the period of congestion.

Use the **no** parameter with this command to disable flow control.

Command Syntax

```
flowcontrol both
flowcontrol send on
flowcontrol send off
flowcontrol receive on
flowcontrol receive off
no flowcontrol
```

Parameters

both

Specify flow control mode for sending or receiving.

send

Specify flow control mode for sending.

receive

Specify the flow control mode for receiving.

off

Turn off flow control.

on

Turn on flow control.

Default

The flow control is enabled globally and auto-negotiation is on, flow control is enabled and advertised on 10/100/1000M ports. If auto-negotiation is off or if the port speed was configured manually, flow control is neither negotiated with nor advertised to the peer.

Command Mode

Interface mode

Applicability

This command was introduced before OcNOS version 1.3.

Examples

```
#configure terminal
(config)#interface eth1
```

```
(config-if)#flowcontrol receive off

#configure terminal
(config)#interface eth1
(config-if)#flowcontrol receive on

(config)#interface eth1
(config-if)#no flowcontrol
```

hardware-profile portmode

Use this command to set the global port mode.

Command Syntax

```
hardware-profile portmode (4X10g|40g)
```

Parameters

4X10g

Split all the 40G flex ports on the system

40g

Disable splitting on all flex ports and make all ports 40G

Default

None

Command Mode

Configure mode

Applicability

This command was introduced before OcNOS version 1.3.

Examples

```
#configure terminal  
(config)#hardware-profile portmode 40g
```

if-arbiter

Use this command to discover new interfaces recently added to the kernel and add them to the OcNOS database.

This command starts the arbiter to check interface information periodically. OcNOS dynamically finds any new interfaces added to the kernel. If an interface is loaded dynamically into the kernel when OcNOS is already running, this command polls and updates the kernel information periodically.

Use the **no** parameter with this command to revert to default.

Command Syntax

```
if-arbiter (interval <1-65535>|)
no if-arbiter
```

Parameters

interval <1-65535>

Interval (in seconds) after which NSM sends a query to the kernel.

Default

By default, **if-arbiter** is disabled. When interface-related operations are performed outside of OcNOS (such as when using the **ifconfig** command), enable **if-arbiter** for a transient time to complete synchronization. When synchronization is complete, disable it by giving the **no if-arbiter** command.

Command Mode

Configure mode

Applicability

This command was introduced before OcNOS version 1.3.

Example

```
#configure terminal
(config)#if-arbiter interval 5
```

interface

Use this command to select an interface to configure, and to enter the **Interface** command mode.

Use the **no** parameter with this command to remove this configuration.

Command Syntax

```
interface IFNAME
no interface IFNAME
```

Parameter

IFNAME

Name of the interface.

Default

None

Command Mode

Configure mode

Applicability

This command was introduced before OcNOS version 1.3.

Example

This example shows the use of this command to enter the **Interface** mode (note the change in the prompt).

```
#configure terminal
(config)#interface eth3
(config-if)#
```

ip address A.B.C.D/M

Use this command to specify that an IP address and prefix length will be used by this interface. If the **secondary** parameter is not specified, this command overwrites the primary IP address. If the **secondary** parameter is specified, this command adds a new IP address to the interface. The secondary address cannot be configured in the absence of a primary IP address. The primary address cannot be removed when a secondary address is present.

Use the **no** parameter with this command to remove the IP address from an interface.

Command Syntax

```
ip address A.B.C.D/M label LINE
ip address A.B.C.D/M (secondary|)
ip address A.B.C.D/M secondary label LINE
no ip address A.B.C.D/M label LINE
no ip address A.B.C.D/M secondary label LINE
no ip address (A.B.C.D/M (secondary|) |)
```

Parameters

LINE

Label of this address.

secondary

Make the IP address secondary.

Default

None

Command Mode

Interface mode

Applicability

This command was introduced before OcNOS version 1.3.

Examples

```
(config)#interface eth3
(config-if)#ip address 10.10.10.50/24
(config-if)#ip address 10.10.11.50/24 secondary
```

ip address dhcp

Use this command to specify that a **DHCP client**¹ will be used to obtain an IP address for an interface.

Use the **no** parameter with this command to remove the IP address from an interface.

Command Syntax

```
ip address dhcp
no ip address dhcp
```

Parameters

None

Default

None

Command Mode

Interface mode

Applicability

This command was introduced before OcNOS version 1.3.

Examples

```
(config)#interface eth3
(config-if)#ip address 10.10.10.50/24
(config-if)#ip address 10.10.11.50/24 secondary
(config-if)#ip address dhcp
```

¹A DHCP client is a hardware device or software that uses DHCP to get the network configuration information from a DHCP Server. VRF: VRF creates a logically isolated routing table within a single physical network device. Each VRF instance works as an independent routing instance that enables separate network traffic, maintains different routing tables, and provides network isolation.

ip forwarding

Use this command to turn on IP forwarding.

Use the `no` parameter with this command to turn off IP forwarding.

Command Syntax

```
ip forwarding
ip forwarding vrf NAME
no ip forwarding
no ip forwarding vrf NAME
```

Parameters

NAME

Virtual Routing and Forwarding name

Default

None

Command Mode

Configure mode

Applicability

This command was introduced before OcNOS version 1.3.

Examples

```
#configure terminal
(config)#ip forwarding
```

ip prefix-list

Use this command to create an entry for a prefix list.

A router starts to match prefixes from the top of the prefix list and stops whenever a match or deny occurs. To promote efficiency, use the **seq** parameter and place common matches or denials towards the top of the list. The sequence values are generated in the sequence of 5.

Use the parameters **ge** and **le** specify the range of the prefix length to be matched. When setting these parameters, set **le** to be less than 32 and **ge** to be less than **le** value.

Use the **no** parameter with this command to delete the prefix-list entry.

Command Syntax

```
ip prefix-list WORD
  (deny|permit) (A.B.C.D/M|any)
  (deny|permit) A.B.C.D/M eq <0-32>
  (deny|permit) A.B.C.D/M ge <0-32>
  (deny|permit) A.B.C.D/M ge <0-32> le <0-32>
  (deny|permit) A.B.C.D/M le <0-32>
  (deny|permit) A.B.C.D/M le <0-32> ge <0-32>
  seq <1-4294967295> (deny|permit) (A.B.C.D/M|any)
  seq <1-4294967295> (deny|permit) A.B.C.D/M eq <0-32>
  seq <1-4294967295> (deny|permit) A.B.C.D/M ge <0-32>
  seq <1-4294967295> (deny|permit) A.B.C.D/M ge <0-32> le <0-32>
  seq <1-4294967295> (deny|permit) A.B.C.D/M le <0-32>
  seq <1-4294967295> (deny|permit) A.B.C.D/M le <0-32> ge <0-32>
  description LINE
  no seq <1-4294967295> (deny|permit) (A.B.C.D/M|any)
  no description LINE
  no description
no ip prefix-list WORD
ip prefix-list sequence-number
no ip prefix-list sequence-number
```

Parameters

WORD

Name of the prefix list.

deny

Reject packets.

permit

Accept packets.

A.B.C.D/M

IP address mask and length of the prefix list mask.

eq

Exact prefix length to be matched

le

Maximum prefix length to be matched

ge

Minimum prefix length to be matched

<0-32>

Prefix length to match

<1-4294967295>

Sequence number of the prefix list.

any

Take all packets of any length. This parameter is the same as using 0.0.0.0/0 le 32 for **A.B.C.D/M**.

sequence-number

To suppress sequence number generation, give the **no ip prefix-list sequence-number** command. If you disable the generating sequence numbers, you must specify the sequence number for each entry using the sequence number parameter in the **ip prefix-list** command.

To enable sequence number generation, give the **ip prefix-list sequence-number** command.

LINE

Up to 80 characters describing this prefix-list.

Default

None

Command Mode

Configure mode and IP prefix-list mode

Applicability

This command was introduced before OcNOS Version SP 4.0.

Examples

In this configuration, the **ip prefix-list** command matches all, but denies the IP address range, 76.2.2.0.

```
#conf t
(config)#router bgp 100
(config-router)#network 172.1.1.0
(config-router)#network 172.1.2.0
(config-router)#
(config-router)#neighbor 10.6.5.3 remote-as 300
(config-router)#neighbor 10.6.5.3 prefix-list mylist out
(config-router)#exit
(config)#ip prefix-list mylist
(config-ip-prefix-list)#seq 5 deny 76.2.2.0/24
(config-ip-prefix-list)#seq 10 permit 0.0.0.0/0
```

ip proxy-arp

Use this command to enable the proxy ARP feature on an interface.

Use the `no` parameter to disable the proxy ARP feature on an interface.

Command Syntax

```
ip proxy-arp
no ip proxy-arp
```

Parameters

None

Default

By default, the ip proxy-arp is disabled

Command Mode

Interface mode

Applicability

This command was introduced before OcNOS version 1.3.

Example

```
#configure terminal
(config)#interface eth3
(config-if)#ip proxy-arp
```

ip remote-address

Use this command to set the remote address (far end) on a point-to-point non multi-access link. This command can be used only on unnumbered interfaces. When a new remote-address is configured, the old address gets overwritten.

Use the **no** parameter to disable this function.

Command Syntax

```
ip remote-address A.B.C.D/M
no ip remote-address
```

Command Syntax

A.B.C.D/M

IP address and prefix length of the link remote address.

Default

None

Command Mode

Interface mode

Applicability

This command was introduced before OcNOS version 1.3.

Example

```
(config)#interface ppp0
(config-if)#ip unnumbered eth1
(config-if)#ip remote-address 1.1.1.1/32
```

ip unnumbered

Use this command to enable IP processing without an explicit address on a point-to-point non multi-access link. Moreover, this command lets an interface borrow the IP address of a specified interface to enable IP processing on a point-to-point interface without assigning it an explicit IP address. In this way, the IP unnumbered interface can borrow the IP address of another interface already configured on the router to conserve network and address space.

Use the `no` parameter with this command to remove this feature on an interface.

Command Syntax

```
ip unnumbered IFNAME
no ip unnumbered
```

Parameters

IFNAME

Interface name.

Command Mode

Interface mode

Applicability

This command was introduced before OcNOS version 1.3.

Examples

The following example creates a tunnel on `eth1`.

```
(config)#interface lo
(config-if)#ip address 127.0.0.1/8
(config-if)#ip address 33.33.33.33/32 secondary
(config-if)#exit
(config)#interface eth1
(config-if)#ip address 10.10.10.145/24
(config-if)#exit
(config)#interface Tunnel0
(config-if)#tunnel source 10.70.0.145
(config-if)#tunnel destination 10.70.0.77
(config-if)#tunnel ttl 255
(config-if)#tunnel path-mtu-discovery
(config-if)#tunnel mode vxlan
(config-if)#ip unnumbered eth1
(config-if)#exit
(config)#router ospf
(config-router)#network 10.10.10.0/24 area 0
```

ip vrf forwarding

This command associates an interface with a **VRF**¹.

Use the **no** parameter with this command to unbind an interface.



Notes:

- When you give this command in interface configuration or subinterface configuration mode of the parent VR, the IP address and other attributes of the interface are deleted from the interface. After giving this command, the IP attributes must then be configured in the context of the VRF.
- The Out Of Band (OOB) management port is part of the “management” VRF. Also, this port cannot be moved out of “management” VRF.

Command Syntax

```
ip vrf forwarding WORD
no ip vrf forwarding WORD
```

Parameters

WORD

Name of the VRF.

Default

None

Command Mode

Interface mode

Applicability

This command was introduced before OcNOS version 1.3.

Example

```
#configure terminal
(config)#ip vrf myVRF
(config-vrf)#exit
(config)#interface eth1
(config-if)#ip vrf forwarding myVRF
```

¹Virtual Routing and Forwarding

ipv6 address

Use this command to configure the global IPv6 address using the learned prefix and user provided suffix.

Use the `no` form of this command to remove the configuration.

Command Syntax

```
ipv6 address PREFIX-NAME X:X::X:X/M
no ipv6 address PREFIX-NAME X:X::X:X/M
```

Parameters

PREFIX-NAME

Name of the prefix which stores the address-prefix learnt using prefix delegation enabled in the client interface

X:X::X:X/M

Suffix address consists subnet id and host address. This value must start with '::', and end with a /64 bit prefix.

Default

DHCPv6 IA_PD option is not requested by default.

Command Mode

Interface mode

Applicability

This command was introduced in OcNOS version 4.2.OcNOS version 1.3.9

Examples

```
#configure terminal
(config)#interface xe1
(config-if)#ipv6 address dhcp
(config-if)#ipv6 dhcp prefix-delegation prefix_xe1
(config-if)#

(config)#interface xe3
(config-if)#ipv6 address prefix_xe1 ::1:0:0:0:1/64
(config-if)#
```

ipv6 forwarding

Use this command to turn on IPv6 forwarding.

Use the `no` parameter with this command to turn off IPv6 forwarding.

Command Syntax

```
ipv6 forwarding
ipv6 forwarding vrf NAME
no ipv6 forwarding
no ipv6 forwarding vrf NAME
```

Parameters

NAME

Virtual Routing or Forwarding name

Default

None

Command Mode

Command mode

Applicability

This command was introduced before OcNOS version 1.3.

Example

```
#configure terminal
(config)#ipv6 forwarding
```

ipv6 prefix-list

Use this command to create an entry for an ipv6 prefix-list.

Router starts to match prefixes from the top of the prefix list, and stops whenever a match or deny occurs. To promote efficiency, use the **seq** parameter and place common matches or denials towards the top of the list. The sequence values are generated in the sequence of 5.

The parameters **ge** and **le** specify the range of the prefix length to be matched.

Use the **no** parameter with this command to delete the prefix-list entry.

Command Syntax

```

ipv6 prefix-list WORD
(deny|permit) (X:X::X:X/M|any)
(deny|permit) X:X::X:X/M ge <0-128>
(deny|permit) X:X::X:X/M ge <0-128> le <0-128>
(deny|permit) X:X::X:X/M le <0-128>
(deny|permit) X:X::X:X/M le <0-128> ge <0-128>
seq <1-4294967295> (deny|permit) (X:X::X:X/M|any)
seq <1-4294967295> (deny|permit) X:X::X:X/M ge <0-128>
seq <1-4294967295> (deny|permit) X:X::X:X/M ge <0-128> le <0-128>
seq <1-4294967295> (deny|permit) X:X::X:X/M le <0-128>
seq <1-4294967295> (deny|permit) X:X::X:X/M le <0-128> ge <0-128>
description LINE
no seq <1-4294967295> (deny|permit) (X:X::X:X/M|any)
no description
no ipv6 prefix-list WORD
ipv6 prefix-list sequence-number
no ipv6 prefix-list sequence-number

```

Parameters

WORD

Name of the prefix list.

deny

Reject packets.

permit

Accept packets.

X:X::X:X/M

IP address mask and length of the prefix list mask.

any

Take all packets of any length. This is the same as specifying `::/0` for `X:X::X:X/M`.

le

Maximum prefix length match

ge

Minimum prefix length match

<0-128>

Prefix length to match

<1-4294967295>

Sequence number of the prefix list.

sequence-number

To suppress sequence number generation, give the `no ipv6 prefix-list sequence-number` command. If you disable the generating sequence numbers, you must specify the sequence number for each entry using the sequence number parameter in the `ipv6 prefix-list` command.

To enable sequence number generation, give the `ipv6 prefix-list sequence-number` command.

LINE

Up to 80 characters describing this prefix-list.

Default

None

Command Mode

Configure mode

Applicability

This command was introduced before OcNOS version 1.3.

Examples

```
#configure terminal
(config)#ipv6 prefix-list mylist
(config-ipv6-prefix-list)#seq 12345 deny 3ffe:345::/16 le 22 ge 14
```

ipv6 unnumbered

Use this command to enable IPv6 processing without an explicit address, on a point-to-point non multi-access link.

This command lets an interface borrow the IPv6 address of a specified interface to enable IPv6 processing on a point-to-point interface without assigning it an explicit IPv6 address. In this way, the IPv6 unnumbered interface can borrow the IPv6 address of another interface already configured on the router to conserve network and address space.

Use the **no** parameter with this command to remove this feature on an interface.

Command Syntax

```
ipv6 unnumbered IFNAME
no ipv6 unnumbered
```

Parameters

IFNAME

Interface name.

Default

None

Command Mode

Interface mode

Applicability

This command was introduced before OcNOS version 1.3.

Example

The following example creates a tunnel on eth1.

```
#configure terminal
(config)#interface lo
(config-if)#ipv6 address ::1/128
(config-if)#exit
(config)#interface eth1
(config-if)#ipv6 address fe80::20e:cff:fe6e:56dd/64
(config-if)#exit
(config)#interface Tunnel0
(config-if)#tunnel source 10.70.0.145
(config-if)#tunnel destination 10.70.0.77
(config-if)#tunnel ttl 255
(config-if)#tunnel path-mtu-discovery
(config-if)#tunnel mode vxlan
(config-if)#ipv6 unnumbered eth1
(config-if)#ipv6 router ospf area 0 tag 1
(config-if)#exit
(config)#router ipv6 ospf 1
(config-router)#router-id 10.70.0.145
```

link-debounce-time

Use this command to set the debounce time for linkup and linkdown transitions for the interface.

User can set only one of the timers (either linkup or linkdown) by setting the other one to 0.

Use the **no** form of this command to turn off the link debounce timer on the interface.

Command Syntax

```
link-debounce-time <0-5000> <0-5000>  
no link-debounce-time
```

Parameters

<0-5000>

timer value in milliseconds for the linkup transition

<0-5000>

timer value in milliseconds for the linkdown transition

Default

None

Command Mode

Interface mode

Applicability

This command was introduced before OcNOS version 5.0.

Example

```
#configure terminal  
(config)#interface eth1  
(config-if)#link-debounce-time 4000 5000  
(config-if)#link-debounce-time 0 5000  
(config-if)#link-debounce-time 3000 0
```

load interval

Use this command to configure the interval for which average traffic rate need to be shown. Intervals can be configured in steps of 30 seconds.

Use the no parameter with this command to set the load interval to its default.

Command Syntax

```
load-interval <30-300>  
no load-interval
```

Parameters

<30-300>

Load period in multiples of 30 seconds.

Default

By default, load interval is 300 seconds

Command Mode

Interface mode

Applicability

This command was introduced before OcNOS version 1.3.

Example

```
#configure terminal  
(config)#interface xe1/1  
(config-if)#load-interval 30  
(config-if)#no load-interval
```

loopback

Use this command to loopback TX or RX packets at MAC or PHY level.

Use the `no` form of the command to remove loopback configuration.

Command Syntax

```
loopback (tx | rx) (mac | phy)
no loopback
```

Parameters

- tx**
Loopback TX packets
- rx**
Loopback RX packets
- mac**
Loopback TX or RX packets at MAC level
- phy**
Loopback TX or RX packets ar PHY level

Default

None

Command Mode

Interface mode

Applicability

This command was introduced before OcNOS version 5.0.

Example

```
#configure terminal
(config)#int ce1/2
(config-if)#loopback rx phy

#configure terminal
(config)#int ce1/2
(config-if)#no loopback
```

loss-measurement dynamic

This command enables the loss measurement. This command is tied to the delay measurement session already created to measure the delay. In case this command is issued without the delay-measurement command previously issued, an error is returned.

Use the **no** form of this command to disable the loss measurement.

Command Syntax

```
loss-measurement dynamic
no loss-measurement dynamic
```

Parameters

None

Default

None

Command Mode

Interface mode

Applicability

This command was introduced before OcNOS version 5.1.

Example

```
#configure terminal
(config)#interface xel
(config-if)#loss-measurement dynamic
(config-if)#no loss-measurement dynamic
```

loss-measurement uni-link-loss

Use this command to advertise the loss (as a packet percentage) between two directly connected IS-IS/OSPF neighbors.

The A bit is set when the measured value of this parameter exceeds its configured maximum threshold. The A bit is cleared when the measured value falls below its configured reuse threshold.

Use the **no** parameter with this command to unset uni-link-loss on the current interface.

Command Syntax

```
loss-measurement uni-link-loss ((static VALUE) | (a-bit-threshold min VALUE max VALUE))
no loss-measurement uni-link-loss (static | a-bit-threshold)
```

Parameters

static

Static value

VALUE

Loss percentage in six precision float format. eg: 3.123456

a-bit-threshold

Threshold values to set/clear A-bit

min

Reuse threshold

VALUE

Reuse threshold percentage in six precision float format. eg:3.123456

max

Maximum threshold

VALUE

Maximum threshold percentage in six precision float format. eg:3.123456

Default

None

Command Mode

Interface mode

Applicability

This command was introduced in OcNOS version 5.0.

Examples

```
#configure terminal
(config)#interface eth1
(config-if)#loss-measurement uni-link-loss static 12.3
(config-if)#no loss-measurement uni-link-loss static
(config-if)#loss-measurement uni-link-loss a-bit-threshold min 1.12 max 2.2
(config-if)#no loss-measurement uni-link-loss a-bit-threshold
```

mac-address

Use this command to configure a MAC address for Layer 3 interfaces. Interface can be Layer 3 physical interface or routed VLAN interface or port-channel.

Use the **no** form of this command to remove the MAC address from an interface.

Command Syntax

```
mac-address HHHH.HHHH.HHHH
no mac-address
```

Parameters

mac-address

Mac-address in HHHH.HHHH.HHHH format (only supported on L3 Interfaces)

Default

None

Command mode

Interface mode

Applicability

This command was introduced before OcNOS version 6.4.2.

Examples

```
OcNOS(config)#int xe46
OcNOS(config-if)#mac-address 00e0.aaaa.bbbb
```

monitor speed

Use this command to enable speed monitoring on interface.

Use the `no` parameter with this command to disable monitoring.

Command Syntax

```
monitor speed
no monitor speed
```

Parameters

None

Default

By default, speed monitoring will be disabled

Command Mode

Interface mode

Applicability

This command was introduced in OcNOS version 3.0.

Example

```
#configure terminal
(config)#interface xe1/1
(config-if)#monitor speed
(config-if)#no monitor speed
```

monitor queue-drops

Use this command to enable queue-drops monitoring on interface.

Use the `no` parameter with this command to disable monitoring.

Command Syntax

```
monitor queue-drops
no monitor queue-drops
```

Parameters

None

Default

By default, queue-drops monitoring will be disabled

Command Mode

Interface mode

Applicability

This command was introduced in OcNOS version 3.0.

Example

```
#configure terminal
(config)#interface xe1/1
(config-if)#monitor queue-drops
(config-if)#no monitor queue-drops
```

monitor speed threshold

Use this command to modify default speed monitor threshold on interface.

Use the `no` parameter with this command to set the monitor speed threshold to its default.



Note: Warning threshold must be greater than recovery threshold and it is recommended to keep a difference of 10 percent to avoid frequent notifications caused by variations in average speed.

Command Syntax

```
monitor speed threshold warning <1-100> recovery <1-100>
no monitor speed threshold
```

Parameters

warning <1-100>

Warning level threshold value in percentage

recovery <1-100>

Recovery level threshold value in percentage

Default

By default, warning threshold is 90 percentage and recovery is 80 percentage.

Command Mode

Interface mode

Applicability

This command was introduced in OcNOS version 3.0.

Example

```
#configure terminal
(config)#interface xe1/1
(config-if)# monitor speed threshold warning 80 recovery 70
(config-if)#no monitor speed threshold
```

mtu

Use this command to set the Maximum Transmission Unit (MTU) and Maximum Receive Unit (MRU) for an interface. Use the `no` parameter with this command to set the MTU to its default.



Notes:

- To allow jumbo frames over **SVI**¹ interfaces, it is mandatory to configure the applicable MTU for the specific SVI interfaces.
- Set the maximum MTU on the parent interface to 9390 to create a VxLAN port-VLAN access interface.

Limitation for MTU configuration on Label-Switching

1. Creating a sub-interface automatically increases the physical interface MTU size by 8 bytes to accommodate double VLAN tag encapsulation.
2. Configuring label switching for physical layer-3 interfaces adds 20 bytes internally to the MTU to accommodate up-to five labels. However, configuring label-switching on sub-interface does not change the MTU of physical interface. Hence, the physical interface requires a manual increase in MTU size.
3. During the BGP update, in case the control packet contains 1500 bytes when it reaches the hardware, the hardware adds the Encapsulation for the sub-interface. Now, the hardware drops it as physical port MTU is limited to 1500 bytes.
4. Configuring higher MTU on network ports is recommended compared to access ports. Hence, the MTU on physical and sub-interfaces should be increased to accommodate the **PDU**².

Command Syntax

```
mtu <64-65536>  
no mtu
```

Parameters

<64-65536>

Specify the size of MTU in bytes:

<64-16338> for L2 packet

<576-9216> for L3 IPv4 packet

<1280-9216> for L3 IPv6 packet

<576-65536> for IPv4 packet

<1280-65536> for IPv6 packet on loopback interface

Default

By default, MTU is 1500 bytes

¹Switched Virtual Interface

²A unit of data transmitted as a composite by a protocol.

Command Mode

Interface mode

Applicability

This command was introduced before OcNOS version 1.3.

Example

```
#configure terminal
(config)#interface eth3
(config-if)#mtu 120
```

multicast

Use this command to set the multicast flag for the interface.

Use the `no` form of this command to disable this function.

Command Syntax

```
multicast
no multicast
```

Parameters

None

Default

None

Command Mode

Interface mode

Applicability

This command was introduced before OcNOS version 1.3.

Example

```
#configure terminal
(config)#interface eth3
(config-if)#multicast
```

show flowcontrol

Use this command to display flow control information.

Command Syntax

```
show flowcontrol
show flowcontrol interface IFNAME
```

Parameters

interface IFNAME

Specify the name of the interface to be displayed.

Default

None

Command Mode

Execution mode and Privileged execution mode

Applicability

This command was introduced before OcNOS version 1.3.

Example

The following is a sample output of the **show flowcontrol interface** command displaying flow control information.

```
#show flowcontrol interface ge1
Port      Send FlowControl  Receive FlowControl RxPause TxPause
          admin   oper      admin   oper
-----  -
ge1      on     on        on     on          0      0
```

Here is the explanation of the show command output fields.

Table 86. show flow control output

Entry	Description
Port	Interface being checked for flowcontrol.
Send admin	Displays whether the flowcontrol send process is administratively on or off.
FlowControl oper	Displays whether send flowcontrol is on or off on this interface.
Received admin	Displays whether the flowcontrol receive process is administratively on or off.

Table 86. show flow control output (continued)

Entry	Description
FlowControl oper	Displays whether receive flowcontrol is on or off on this interface.
RxPause	Number of received pause frames.
TxPause	Number of transmitted pause frames.

show hardware-discard-counters

Use this command to check device level discard counters.

Command Syntax

```
show hardware-discard-counters
```

Parameters

None

Default

None

Command Mode

Execution mode

Applicability

The command is introduced before OcNOS version 1.3.

Examples

```
#show hardware-discard-counters
+-----+-----+
| Registers | Core 0 |
+-----+-----+
CGM_VOQ_SRAM_ENQ_RJCT_PKT_CTR          437
Reason : QNUM_NOT_VALID                 Y
EGQ_PQP_DISCARD_UNICAST_PACKET_COUNTER 8894
Reason : SRC_EQUAL_DEST_INT             Y
```

Here is the explanation of the show command output fields.

Table 87. Table detailing about counters supported

Register	Description
CGM_VOQ_SRAM_ENQ_RJCT_PKT_CTR for QAX IQM_QUEUE_ENQ_DISCARDED_PACKET_COUNTER for QMX	Drop is due to PPdecision to drop, or invalid destination received from PPblocks. The packet DP (Drop Precedence) is higher than the configured Drop DP.
EGQ_PQP_DISCARD_UNICAST_PACKET_COUNTER	Seen with unknown unicast frames, source and destination learnt from same interface.

Table 88. Table detailing about reasons supported

Register	Description
QNUM_NOT_VALID for QAX	Seen with Vlan Discards, ACL Drops, Storm Control, STP

Table 88. Table detailing about reasons supported (continued)

Register	Description
QUEUE_NOT_VALID_STATUS for QMX DP_LEVEL_RJCT for QAX DP_LEVEL_STATUS for QMX	Blocked Port. Seen with Policer Discards.
SRC_EQUAL_DEST_INTF	Seen when traffic is not learned, but is still forwarded/flooded.

show interface

Use this command to display interface configuration and status information.

Command Syntax

```
show interface (IFNAME|)
show interface brief (IFNAME|)
```

Parameters

IFNAME

Interface name.

Default

None

Command Mode

Execution mode and Privileged execution mode

Applicability

This command was introduced before OcNOS version 1.3.

Example

```
#show interface xe1/1
Interface xe1/1
  Scope: both
  Flexport: Breakout Control Port (Active): Break Out Enabled
  Hardware is ETH Current HW addr: ecf4.bb6e.934b
  Physical:ecf4.bb6e.934b Logical:(not set)
  Port Mode is access
  Interface index: 5001
  Metric 1 mtu 1500 duplex-full(auto) link-speed 1g(auto)
  <UP,BROADCAST,RUNNING,MULTICAST>
  VRF Binding: Not bound
  Label switching is disabled
  No Virtual Circuit configured
  DHCP client is disabled.
  Last Flapped: 2016 Nov 05 22:40:23 (00:19:25 ago)
  Statistics last cleared: 2016 Nov 05 04:49:55 (18:09:53 ago)
  5 minute input rate 0 bits/sec, 0 packets/sec
  5 minute output rate 256 bits/sec, 0 packets/sec
  RX
    unicast packets 39215813 multicast packets 0 broadcast packets 0
    input packets 39215813 bytes 2666662432
    jumbo packets 0
    runts 0 giants 0 CRC 0 fragments 0 jabbers 0
    input error 0
    input with dribble 0 input discard 0
    Rx pause 0
  TX
    unicast packets 38902 multicast packets 437 broadcast packets 0
    output packets 437 bytes 28018
    jumbo packets 0
    output errors 0 collision 0 deferred 0 late collision 0
```

```
output discard 0
Tx pause 0
```

Here is the explanation of the show command output fields.

Table 89. show interface output details

Field	Description
Scope	Interface can be used for communication within the device and outside the device (Both).
Flexport	Specifies whether the ports has Breakout capabilities or is a Non-Control Port.
Breakout Control Port (Active)	Specifies whether Breakout is active or disabled.
Hardware is ETH Current HW addr	The MAC address of the interface.
Physical	Displays the physical MAC address of the interface.
Logical	Displays the logical MAC address (if any) of the interface.
Port Mode	Displays the port mode: Router, VLAN access, switch, or trunk.
Interface index	Index number, Metric, MTU size, duplex-full (auto) or half-duplex, minimum link speed in gigabits, and if the interface is up, broadcasting, and multicasting.
VRF¹ Binding	Show whether the interface is VRF bound and (if bound) with what VRF, if Label Switching is enabled or disabled, and if a virtual circuit is configured.
DHCP client²	The state of the DHCP³ client – whether this interface is connected to a DHCP server.
Last Flapped	Date and time when the interface last flapped.
Statistics last cleared	Date and time when the interface’s statistics were cleared.
5 minute input rate	Input rate in bits/second and packets/second
5 minute output rate	Output rate in bits/second and packets/second
RX	Counters for unicast packets, multicast packets, broadcast packets, input packets, bytes, jumbo packets, runts, giants, CRC errors, fragments, jabbers, input errors, input with dribble input discards, and receive pause.
TX	Counters for unicast packets, multicast packets, broadcast packets, output packets, bytes, jumbo packets, output errors, collisions, differed packets, input late collisions, output discards, and transmit pause.

```
#show interface brief xe51
```

```
Codes: ETH - Ethernet, LB - Loopback, AGG - Aggregate, MLAG - MLAG Aggregate
FR - Frame Relay, TUN -Tunnel, PBB - PBB Logical Port, VP - Virtual Port
```

¹Virtual Routing and Forwarding

²A DHCP client is a hardware device or software that uses DHCP to get the network configuration information from a DHCP Server. VRF: VRF creates a logically isolated routing table within a single physical network device. Each VRF instance works as an independent routing instance that enables separate network traffic, maintains different routing tables, and provides network isolation.

³Dynamic Host Configuration Protocol

CVP - Channelised Virtual Port, METH - Management Ethernet, UNK- Unknown
 ED - ErrDisabled, PD - Protocol Down, AD - Admin Down, IA - InActive
 PD(Min L/B) - Protocol Down Min-Links/Bandwidth
 OTD - Object Tracking Down
 DV - DDM Violation, NA - Not Applicable
 NOM - No operational members, PVID - Port Vlan-id
 Ctl - Control Port (Br-Breakout/Bu-Bundle)

```

-----
Ethernet  Type      PVID  Mode      Status Reason  Speed Port Ch #  Ctl Br/Bu  Loopbk
Interface
-----
xe51      ETH       --    routed    down   OTD     10g  --        No      No
  
```

show interface capabilities

Use this command to display interface capabilities

Command Syntax

```
show interface (IFNAME|) capabilities
```

Parameters

IFNAME

Displays the name of a specific interface for which status and configuration data is desired.

Default

None

Command Mode

Execution mode

Applicability

This command was introduced before OcNOS version 1.3.

Example

```
#show interface xe1/1 capabilities
xe1/1
Speed(FD) : 10MB,100MB,1000MB,10GB,20GB,40GB
Interface : xgmii
Medium : copper
Loopback : none,MAC,PHY
Pause : pause_tx,pause_rx,pause_asymm
Flags : autoneg
Encap : IEEE,HIGIG,HIGIG2
OcNOS#show interface cd49 capabilities
cd49
Speed(FD) : 400GB
Speed(HD) : 400GB
Medium : copper,fiber
Pause : pause_tx/pause_rx/pause_asymm
Encap : IEEE
FEC : RS-272-2xN,RS-544-2xN,BASE-R(CL74),RS(CL91)
OcNOS#show interface cd49/1 capabilities
cd49/1
Speed(FD) : 100GB
Speed(HD) : 100GB
Medium : copper,fiber
Pause : pause_tx/pause_rx/pause_asymm
Encap : IEEE
FEC : RS(CL91),RS-544,RS-272,BASE-R(CL74)
OcNOS#show interface cd49/1 capabilities
cd49/1
Speed(FD) : 40GB,100GB
Speed(HD) : 40GB,100GB
Medium : copper,fiber
Pause : pause_tx/pause_rx/pause_asymm
Encap : IEEE
```

```
FEC : BASE-R (CL74) , RS (CL91) , RS-544 , RS-272-2xN , RS-544-2xN
```

Here is the explanation of the show command output fields.

Table 90. show interface capabilities output details

Field	Description
Interface number	The identifying ID number of the interface – eht0, xe1, etc.
Speed (FD)	The Flexible Data-Rates (FD) of the interface
interface	XAUI is a standard for extending the XGMII (10 Gigabit Media Independent Interface) between the MAC and PHY layer of Gigabit Ethernet.
Medium	Members have to have the same medium type configured. This only applies to Ethernet port-channel. Copper, fiber optics, etc.
Loop back	The loop back between the MAC and PHY layers.
Pause	Pause transmit, pause receive, pause asymmetrically.
Flags	Interface flags set for Auto-negotiation.
Encap	Encapsulation – IEEE, HIGIG, and HIGIG2 specifications – HIGIG is a proprietary protocol that is implemented by Broadcom. The HIGIG protocol supports various switching functions. The physical signaling across the interface is XAUI, four differential pairs for receive and transmit (SerDes), each operating at 3.125 Gbit/s.

show interface counters

Use this command to display the ingress and egress traffic counters on the interface.



Note: Counters are meant for debugging purpose and the accuracy of the transmit discard counter is not guaranteed in all scenarios.

Command Syntax

```
show interface (IFNAME|) counters (active|)
show interface cpu counters
```

Parameters

IFNAME

Interface name.

active

Statistics for link-up interfaces.

cpu

CPU interface.

Command Mode

Execution mode and Privileged execution mode

Applicability

This command was introduced before OcNOS version 1.3.

Example

```
#show interface xe1/1 counters
Interface xe1/1
  Scope: both
  Rx Packets: 1000
  Rx Bytes: 1000000
  Rx Unicast Packets: 1000
  Rx Packets from 512 to 1023 bytes: 1000
  Tx Packets: 3897
  Tx Bytes: 249408
  Tx Multicast Packets: 3897
  Tx Packets with 64 bytes: 3897
  Tx Packet rate: 1 pps
  Tx Bit rate: 255 bps
#show interface cpu counters
CPU Interface
  Tx Packets: 104508
  Tx Bytes: 7106272
  Tx Discard Packets: 89613672
  Tx Discard Bytes: 5735237844
  Rx Discard Packets: 11938
```

Here is the explanation of the show command output fields.

Table 91. show interface counters output details

Field	Description
Receive Counters	Rx Packets Rx Bytes Rx Unicast Packets Rx Multicast Packets Rx Broadcast Packets Rx Packets with 64 bytes Rx Packets from 65 to 127 bytes Rx Packets from 128 to 255 bytes Rx Packets from 256 to 511 bytes Rx Packets from 512 to 1023 bytes Rx Packets from 1024 to 1518 bytes Rx Packets from 1519 to 2047 bytes Rx Packets from 2048 to 4095 bytes Rx Packets from 4096 to 9216 bytes Rx Jumbo Packets Rx Discard Packets Rx Packets with error Rx CRC Error Packets Rx Undersized Packets Rx Oversized Packets Rx Fragment Packets Rx Jabber Packets Rx MAC error Packets Rx Pause Packets Rx Unrecognized MAC Control Packets Rx Drop Events Rx Packet rate Rx Bit rate
Transmit Counters	Tx Packets Tx Bytes Tx Unicast Packets Tx Multicast Packets Tx Broadcast Packets Tx Packets with 64 bytes Tx Packets from 65 to 127 bytes Tx Packets from 128 to 255 bytes

Table 91. show interface counters output details (continued)

Field	Description
	Tx Packets from 256 to 511 bytes Tx Packets from 512 to 1023 bytes Tx Packets from 1024 to 1518 bytes Tx Packets from 1519 to 2047 bytes Tx Packets from 2048 to 4095 bytes Tx Packets from 4096 to 9216 bytes Tx Jumbo Packets Tx Discard Packets Tx Packets with error Tx Collisions Tx Late Collisions Tx Excessive Collisions Tx Pause Packets Tx Packet rate Tx Bit rate
CPU Interface Counters	Tx Packets Tx Bytes Tx Discard Packets Tx Discard Bytes Rx Discard Packets

show interface counters drop-stats

Use this command to display the ingress and egress traffic discard reason counters on the interface.



Notes:

- You can only display statistics for physical ports and cpu ports, but not for the out-of-band management (OOB) management port or logical interfaces.
- Drops in the CPU queue are listed under **Tx Multicast Queue Drops**, whether the packet is unicast or multicast

Command Syntax

```
show interface (IFNAME|) counters drop-stats
show interface cpu counters drop-stats
```

Parameters

IFNAME

Physical interface name

cpu

CPU interface

Default

None

Command Mode

Execution mode and Privileged execution mode

Applicability

This command was introduced before OcNOS version 1.3.1.

Example

```
#show interface xe32/2 counters drop-stats
+-----+-----+-----+-----+
| Counter Description | Count          | Last Increment | Last Increment Time |
+-----+-----+-----+-----+
Rx Bad CRC errors    0                0
Rx Undersize errors  0                0
Rx Oversize errors   0                0
Rx Fragments errors  0                0
Rx Jabbers errors    0                0
Rx Port Block Drops  6                1                2016 Nov 09 08:59:33
Rx Vlan Discards     0                0
Rx ACL/QOS Drops     0                0
Rx Policy Discards   0                0
Rx EGR Port Unavail 38784            5                2016 Nov 09 18:19:31
Rx IBP Discards      0                0
Tx Port Block Drops  359              1                2016 Nov 09 08:59:33
Tx Vlan Discards     0                0
```

```

Tx TTL Discards      0          0
Tx Unknown Discards 359          1          2016 Nov 09 08:59:33
Tx Ucast Queue Drops 0          0
Tx Mcast Queue Drops 0          0
+-----+-----+-----+-----+

```

Here is the explanation of the show command output fields.

Table 92. show interface counters drop-stats output details

Field	Description
Counter Description	Shows the type of packet and/or the reason why the packet was dropped.
Count	The number of packets dropped for each reason.
Last Increment	Number of packets dropped since this command was last entered.
Last Increment Time	Date and time when the last packet was dropped.
Rx Bad CRC errors	Received packets dropped because they didn't pass the cyclic Redundancy Check (CRC).
Rx Undersize errors	Number of received runt packets dropped.
Rx Oversize errors	Number of received giant packets dropped
Rx Fragments errors	Number of received packet fragments dropped
Rx Jabbers errors	Received packets dropped because of jabber – long packet error.
Rx Port Block Drops	Received packets dropped because port blocking is enabled.
Rx Vlan Discards	VLAN received packets dropped because there is no VLAN configured on the port.
Rx ACL/QOS Drops	Received packets match a field processing entry with a drop or color drop action, such as: User-configured ACL that denies traffic Service policy with a police action that drops the traffic received at a rate higher than the configured limit.
Rx Policy ¹ Discards	Received packets dropped because of device policies violated, such as a storm control rate violation.
Rx EGR Port Unavail	No output port can be determined for these received packets. This counter increments along with other counter types in this table because it is a “catchall” for multiple types of discards as shown below: VLAN check failed MTU check failed ACL/QoS drops Policy discards Source MAC is null Destination IP/source IP address is null Source MAC address and destination MAC address are the same

¹A set of rules determining which actions are permitted or denied for a specific user role.

Table 92. show interface counters drop-stats output details (continued)

Field	Description
	Forwarding lookup failure
Rx IBP Discards	Ingress Back Pressure (ingress congestion) when the ingress packets buffer is full for an interface.
Tx Port Block Drops	Transmitted packets dropped because port blocking is enabled.
Tx Vlan Discards	Transmitted VLAN packets dropped because there is no VLAN configured on the port.
Tx TTL Discards	Transmitted packets discarded because their Time To Live (TTL) has ended.
Tx Unknown Discards	Transmitted packets dropped for unknown reason. May have something to do with the condition/configuration of the port at the other end of the connection.
Tx Ucast Queue Drops	Transmitted packets dropped as a result of Unicast buffer overflow.
Tx Mcast Queue Drops	Transmitted packets dropped as a result of Multicast buffer overflow.

show interface counters error-stats

Use this command to display the ingress error traffic counters on the interface.

Command Syntax

```
show interface (IFNAME|) counters error-stats
```

Parameters

IFNAME

Interface name.

Default

None

Command Mode

Execution mode and Privileged execution mode

Applicability

This command was introduced before OcNOS version 1.3.

Example

```
#show interface xe1/1 counters error-stats
+-----+-----+-----+-----+-----+-----+-----+
|Interface|Total errors|Bad CRC|Undersize|Oversize|Fragments|Jabbers|
+-----+-----+-----+-----+-----+-----+-----+
|xe1/1    |120         |8      |100     |10      |2        |0       |
```

The table below explains the columns in the output.

Table 93. error traffic counters

Column	Description	Causes
Interface	Name of the interface	Point of interconnection in network.
Total errors	Total number of all types of errors	Number of errors in network.
Bad CRC	Number of packets received by the port from the network, where the packets have no CRC or a bad CRC.	Packet data modified making the CRC invalid.
Undersize	Total number of packets received that are less than 64 octets long (which exclude framing bits, but include the FCS) and have a good FCS value.	Bad frame generated by the connected device.
Oversize	Number of packets received by the port from the network, where the packets were more than	Faulty hardware, dot1q, or ISL trunking configuration issues.

Table 93. error traffic counters (continued)

Column	Description	Causes
	maximum transmission unit size.	
Fragments	Total number of frames whose length is less than 64 octets (which exclude framing bits, but which include the FCS) and have a bad FCS value.	Ports are configured at half-duplex. Change the setting to full-duplex.
Jabbers	Total number of frames whose length is more than the maximum MTU size. (which exclude framing bits, but which include FCS) and have a bad FCS value.	Ports are configured at half-duplex. Change the setting to full-duplex.

show interface counters (indiscard-stats|outdiscard-stats)

Use this command to display the ingress and egress traffic discard reason counters on the interface.



Note: You can only display statistics for data ports and CPU ports, not for the out-of-band management (OOB) management port or logical interfaces.

Command Syntax

```
show interface (IFNAME|) counters (indiscard-stats|outdiscard-stats)
show interface cpu counters (indiscard-stats|outdiscard-stats)
```

Parameters

IFNAME

Physical Interface name.

indiscard-stats

Discard reasons for ingress dropped packets.

outdiscard-stats

Discard reasons for egress dropped packets.

cpu

CPU Interface.

Default

None

Command Mode

Execution mode and Privileged execution mode

Applicability

This command was introduced before OcNOS version 1.3.

Examples

```
#show interface xe1/3 counters indiscard-stats
+-----+-----+-----+-----+
| Counter Description | Count          | Last Increment | Last Increment Time |
+-----+-----+-----+-----+
| STP Discards       | 0              | 0              |                      |
| Vlan Discards      | 0              | 0              |                      |
| ACL Drops          | 0              | 0              |                      |
| Policy Discards    | 0              | 0              |                      |
| EGR Port Unavail   | 1092867        | 1092867        | 2016 Oct 25 19:54:58 |
| IBP Discards       | 0              | 0              |                      |
+-----+-----+-----+-----+

#show interface counters indiscard-stats
```

```

+-----+-----+-----+-----+-----+-----+
+-----+-----+-----+-----+-----+-----+
| Interface | Port Block Drops | Vlan Discards | ACL/QoS Drops | Policy Discards | EGR Port Unavail
| IBP Discards | Total Discards  |               |               |               |                 |
+-----+-----+-----+-----+-----+-----+
xe1        0          0          35703        0          11
0          35714
xe2        0          0          295744       0          13604
0          309348
xe3        0          0          9501         0          20405
0          29906
xe5        0          0          0            0          13602
0          13602
xe49/1    0          0          0            0          0
20658
xe52/1    0          3          856029       10         13613
0          869642
xe54/1    0          5371       0            0          5371
0          5371
cpu       0          0          0            0          6
0          N/A
    
```

Here is the explanation of the show command output fields.

Table 94. indiscard statistic output details

Statistic	Description
STP Discards	Packets received when the ingress interface is not in STP forwarding state.
Port Block Drops	Packets discarded on an ingress interface where port blocking is configured.
VLAN Discards	VLAN tagged packets received on a port which is not a member of the VLAN or untagged packets received on a trunk port.
ACL/QoS Drops	Incoming packets match a field processing entry with a drop or color drop action, such as: 1. User-configured ACL that denies traffic 2. Service policy with a police action that drops the traffic received at a rate higher than the configured limit
Policy ¹ Discards	Device policies violated, such as a storm control rate violation, source or destination discards when L2 tagged traffic received on router interface.
EGR (Egress) Port Unavail	No output port can be determined for this packet. This counter increments along with other counter types in this table because it is a “catchall” for multiple types of discards as shown below: 1. VLAN check failed 2. MTU check failed 3. ACL/QoS drops 4. Policy discards 5. Source MAC is null 6. Destination IP/source IP address is null 7. Source MAC address and destination MAC address are the same

¹A set of rules determining which actions are permitted or denied for a specific user role.

Table 94. indiscard statistic output details (continued)

	8. Source MAC is configured as static on other interface 9. Forwarding lookup failure
IBP Drops	Ingress Back Pressure (ingress congestion) when the ingress packet buffer is full for an interface.
Total Discards	Total number of ingress dropped packets.

```
#show interface counters outdiscard-stats
+-----+-----+-----+-----+-----+-----+
+-----+-----+-----+-----+-----+-----+
| Interface | Port Block Drops | Vlan Discards | TTL Discards | Unknown Discards | UcastQ
Drops | McastQ Drops | Total Discards |
+-----+-----+-----+-----+-----+-----+
xe1        0          0          0          204338         0          0
           204338
xe2        0          0          0          1094368        0          0
           1094368
xe3        0          0          0          818672         0          0
           818672
xe52/1     0          0          0          1275156        0          0
           1275156
xe54/1     0          0          0          13575          0          0
           13575
cpu       0          0          0          0              N/A        1
014224    N/A
```

Here is the explanation of the show command output fields.

Table 95. outdiscard statistics

Statistics	Description
Port Block Drops	Packets discarded on an egress interface where port blocking is configured.
VLAN Discards	Packets discarded because an invalid VLAN tag is encountered at an egress interface.
TTL Discards	Packets discarded because the Time-To Live (TTL) of the outgoing packet has passed.
Unknown Discards	Packets discarded for other possible reasons like ACL drop in egress or a policer drop in egress. Discards caused by congestion at queues and drops at queues are not counted under unknown discards.
Unicast Queue Drops	Packets dropped in the unicast queues because of congestion.
Multicast Queue Drops	Packets dropped in the multicast queues because of congestion.
Total Discards	Total number of egress dropped packets.

show interface counters protocol

Use this command to display protocol packets received at the CPU by the control plane.

Command Syntax

```
show interface (IFNAME|) counters protocol
```

Parameters

IFNAME

Interface name.

Default

None

Command Mode

Execution mode and Privileged execution mode

Applicability

This command was introduced before OcNOS version 1.3.

Example

```
#show interface counters protocol
Interface ce1/1
  lacp           : 4
  icmp6         : 5
```

Here is the explanation of the show command output fields.

Table 96. show interface counters protocol output details

Field	Description
Interface	Name of the configured interface.
lacp	Total number of lacp protocol in the interface.
icmp6	Total number of icmp6 protocol in the interface.

show interface counters queue-drop-stats

Use this command to display dropped packets in the CPU queue and the last increment time.

Command Syntax

```
show interface cpu counters queue-drop-stats
```

Parameters

cpu
CPU interface.

Default

None

Command Mode

Execution mode and Privileged execution mode

Applicability

This command was introduced before OcNOS version 1.3.

Example

```
#show interface cpu counters queue-drop-stats
+-----+-----+-----+-----+
| Queue Name | Count | Last Increment | Last Increment Time |
+-----+-----+-----+-----+
arp          | 169735545 | 9145653 | 2017 Oct 23 14:33:54
```

Here is the explanation of the show command output fields.

Table 97. show interface counters queue-drop-stats output details

Field	Description
Queue Name	Name of the protocol.
Count	Number of arp protocols in the interface.
Last Increment	Final increment number in the protocol.
Last Increment time	Time of the last increment in the protocol.

show interface counters queue-stats

Use this command to display transmitted and dropped packet and byte counts of individual queues.

Command Syntax

```
show interface (IFNAME|) counters queue-stats
show interface cpu counters queue-stats
```

Parameters

IFNAME

Interface name.

cpu

CPU interface.

Default

None

Command Mode

Execution mode and Privileged execution mode

Applicability

This command was introduced before OcNOS version 1.3.

Example

```
#show interface counters queue-stats
D - Default Queue, U - User-defined Queue
+-----+-----+-----+-----+-----+-----+
|Interface|Queue/Class-map|Q-Size|Output pkts|Output bytes|Dropped pkts|Dropped bytes|
+-----+-----+-----+-----+-----+-----+
xe1/1    q1            (D) 0    12          1368         0            0
xe1/1    mc-q7         (D) 0    1            82           0            0
xe25     q1            (D) 0    6            684          0            0

#show interface xe1/1 counters queue-stats
D - Default Queue, U - User-defined Queue
+-----+-----+-----+-----+-----+-----+
|Queue/Class-map|Q-Size|Tx pkts|Tx bytes|Dropped pkts|Dropped bytes|
+-----+-----+-----+-----+-----+-----+
q0        (D) 0    0        0        0        0
q1        (D) 0    12       1368     0        0
q2        (D) 0    0        0        0        0
q3        (D) 0    0        0        0        0
q4        (D) 0    0        0        0        0
q5        (D) 0    0        0        0        0
q6        (D) 0    0        0        0        0
q7        (D) 0    0        0        0        0
mc-q0     (D) 0    0        0        0        0
mc-q1     (D) 0    0        0        0        0
mc-q2     (D) 0    0        0        0        0
mc-q3     (D) 0    0        0        0        0
mc-q4     (D) 0    0        0        0        0
```

```

mc-q5      (D) 0    0    0    0    0
mc-q6      (D) 0    0    0    0    0
mc-q7      (D) 0    1   82   0    0

#show interface cpu counters queue-stats
E - Egress, I - Ingress, Q-Size is in bytes
+-----+-----+-----+-----+-----+-----+
| Queue/Class-map | Q-Size | Tx pkts | Tx bytes | Dropped pkts | Dropped bytes |
+-----+-----+-----+-----+-----+-----+
igmp          (E) 800592 14519 987292 1304163 88683084
arp          (E) 1250496 1008785 68597380 0 0
    
```

Here is the explanation of the show command output fields.

Table 98. queue flags detail

Flag	Meaning
D	Default queue of the port.
U	User defined queue of the port.
E	Outgoing hello packet's queue in the port.
I	Incoming hello packet's queue in the port.
Q	Hello packet's queue size in bytes.

Here is the explanation of the show command output fields.

Table 99. show interface counters queue-stats output details

Field	Description
Interface	A defined physical interface to which the queue is associated.
Queue/Class-map	Queues associated with a QoS class-map.
Q-Size	The size of a specified queue in bytes.
Output pkts	The number of out bound packets residing in the queues.
Output Bytes	The number of bytes in the outbound queue.
Dropped pkts	The number of packets dropped because of queue overflow.
Dropped bytes	The number of bytes dropped because of queue overflow.
Tx pkts	The number of transmit packets contained in the out bound queue.
Tx bytes	The number of transmit bytes contained in the out bound queue.

show interface counters rate

Use this command to display the average traffic rate over the load interval of the interface.

Command Syntax

```
show interface (IFNAME|) counters rate (kpbs|mbps|gbps|)
show interface cpu counters rate (kpbs|mbps|gbps|)
```

Parameters

IFNAME

Interface name.

kpbs

Kilobits per second.

mbps

Megabits per second.

gbps

Gigabits per second.

cpu

CPU interface.

Default

None

Command Mode

Execution mode and Privileged execution mode

Applicability

This command was introduced before OcNOS version 1.3.

Example

```
#show interface counters rate
+-----+-----+-----+-----+
| Interface | Rx      | Tx      |
|           | bps    | pps    | bps    | pps    |
+-----+-----+-----+-----+
xe1/1      548439552 1008160 544400 1000

#show interface cpu counters rate
Load interval: 30 second
+-----+-----+-----+-----+
| CPU Queue(%) | Rx bps | Rx pps | Tx bps | Tx pps |
+-----+-----+-----+-----+
isis          ( 0%) -   -   742    0
arp           ( 0%) -   -    6     0
```

Here is the explanation of the show command output fields.

Table 100. show interface counters rate output details

Field	Description
Interface	The particular interface.
RX	Number of hello packets received from the neighbor.
TX	Number hello packets transmitted to the neighbor.
bps	Bytes per second.
pps	Packets per second.
CPU Queue	CPU Queues used for various functions. In the example the CPU is maintaining queues for ARP and the IS-IS routing facilities.
Load interval	The length of time for which data is used to compute load statistics.
RX bps	Number of hello packets received from the neighbor in bytes per second.
RX pps	Number of hello packets received from the neighbor in packets per second.
TX bps	Number hello packets transmitted to the neighbor in bytes per second.
Tx pps	Number hello packets transmitted to the neighbor in packets per second.

show interface counters speed

Use this command to display the current average speed on the interface.

Command Syntax

```
show interface (IFNAME|) counters speed (kbps|mbps|gbps|)
```

Parameters

IFNAME

Interface name.

kbps

Kilobits per second.

mbps

Megabits per second.

gbps

Gigabits per second.

Default

None

Command Mode

Execution mode and Privileged execution mode

Applicability

This command was introduced in OcNOS version 3.0.

Example

```
#show interface counters speed
* indicates monitor is active
+-----+-----+-----+-----+-----+-----+-----+-----+
| interface | configured | Threshold(%) | Current average speed |
| speed ( bps) | Warning | Recovery | Rx ( bps) | % | Tx ( bps) | % |
+-----+-----+-----+-----+-----+-----+-----+-----+
ce45      100000000000  90      80      0      0.00  0      0.00
xe7       100000000000  90      80      0      0.00  0      0.00
xe31      100000000000  90      80      0      0.00  0      0.00
xe33      100000000000  90      80      0      0.00  0      0.00
xe39      100000000000  90      80      0      0.00  0      0.00
xe40      100000000000  90      80      0      0.00  0      0.00
```

show interface counters summary

Use this command to display the summary of traffic counters on a specific interface or all interfaces.



Note: This command is supported for the out-of-band management (OOB) management interface.

Command Syntax

```
show interface (IFNAME|) counters summary
```

Parameters

IFNAME

Interface name.

Default

None

Command Mode

Execution mode and Privileged execution mode

Applicability

This command was introduced before OcNOS version 1.3.

Example

```
#show interface xe1/1 counters summary
```

Interface	Rx		Tx	
	packets	bytes	packets	bytes
xe1/1	11032977	11032960000	61	3904

```
#show interface counters summary
```

Interface	Rx packets	Rx bytes	Tx packets	Tx bytes
eth0	206222	13756391	235123	337010937
po1	809121	72989094	825221	90605534
xe1/1	0	0	1	114
xe3/1	43	4730	21	2298
xe5/1	29	3178	21	2298
xe8	10	1076	14	1532
xe9/1	16	1760	21	2298
xe11/1	0	0	7	766
xe19/1	12426292	1298526692	6	620
xe21/1	13	1386	14	1532
xe28/1	3144	202370	21	2298
xe30/1	3161	202304	7	766
xe32/1	694067	61687838	710274	79315093
xe32/2	115054	11301256	114947	11290441

```

xe32/3      603759      51208946    620502      68865557
xe32/4      7              766         7           766

```

Here is the explanation of the show command output fields.

Table 101. show interface counters summary output details

Field	Description
Interface	The particular interface.
RX	Number of hello packets received from the neighbor.
TX	Number hello packets transmitted to the neighbor.
bps	Bytes per second.
pps	Packets per second.
RX bps	Number of hello packets received from the neighbor in bytes per second.
RX pps	Number of hello packets received from the neighbor in packets per second.
TX bps	Number hello packets transmitted to the neighbor in bytes per second.
Tx pps	Number hello packets transmitted to the neighbor in packets per second.

show interface fec

Use this command to display the forward error correction (**FEC**¹) statistics for an interface.



Note: Displays only FEC statistics for physical interfaces, not management or logical interfaces.

Command Syntax

```
show interface (IFNAME|) fec
```

Parameters

IFNAME

Specifies the physical interface name.

Default

None

Command Mode

Execution mode and Privileged execution mode

Applicability

Introduced before OcNOS version 1.3. Introduced new fields, `bit error`, and `symbol error`; renamed the fields from `Corrected Block Count` and `Uncorrected Block Count` to `Corrected Codeword Count` and `Uncorrected Codeword Count` in the show output display in OcNOS version 6.6.0.

Example

```
OcNOS#show interface fec
+-----+-----+-----+-----+-----+-----+
+-----+-----+-----+-----+-----+-----+
|Interface      |Config |HW Status|Oper Status|Corrected Codeword Count|Uncorrected Codeword
Count|Bit Error  |Symbol Error|
+-----+-----+-----+-----+-----+-----+
+-----+-----+-----+-----+-----+-----+
cd1            auto    RS544_2xN  RS544_
2xN  3916680617      48          3751187751  3923420622
ce2            auto    off        off         0          0
0              0
ce3            auto    off        off         0          0
0              0

OcNOS#show interface cd1 fec
+-----+-----+-----+-----+-----+-----+
+-----+-----+-----+-----+-----+-----+
|Interface      |Config |HW Status|Oper Status|Corrected Codeword Count|Uncorrected Codeword
Count|Bit Error  |Symbol Error|
+-----+-----+-----+-----+-----+-----+
+-----+-----+-----+-----+-----+-----+

```

¹FEC is a technique that detects and corrects errors during data transmission to maintain the reliability of the communication system.

```

cd1
2xN 3930398699 auto RS544_2xN RS544_
48 3764260805 3937147040

```

Here is the explanation of the show command output fields.

Table 102. show interface fec

Field	Description
Interface	Name of the configured interface.
Config	Configured value
HW Status	FEC currently programmed in hardware (HW).
Oper Status	FEC currently operating over the link.
Corrected Codeword Count	Number of the corrected codeword count.
Uncorrected Codeword Count	Number of the uncorrected codeword count.
Bit Error	Number of individual RX RS-FEC bit errors.
Symbol Error	Number of individual RX RS-FEC symbol errors.

show ip forwarding

Use this command to display the IP forwarding status.

Command Syntax

```
show ip forwarding
```

Parameters

None

Default

None

Command Mode

Execution mode and Privileged execution mode

Applicability

This command was introduced before OcNOS version 1.3.

Example

The following is a sample output of the `show ip forwarding` command displaying the IP forwarding status.

```
#show ip forwarding
vrf (management) :IP forwarding is on
vrf (default) :IP forwarding is on
```

The table below explains the fields in the command output.

Table 103. show ip forwarding

Field	Description
vrf (management)	Management VRF ¹ is for management purposes. IP forwarding packet is on.
vrf (default)	The default VRF uses the default routing context for ip forwarding. IP forwarding packet is on.

¹Virtual Routing and Forwarding

show ip interface

Use this command to display brief information about interfaces and the IP addresses assigned to them. To display information about a specific interface, specify the interface name with the command.

Command Syntax

```
show ip interface brief
show ip interface IFNAME brief
```

Parameters

IFNAME

Interface name.

brief

Brief summary of IP status and configuration.

Default

None

Command Mode

Execution mode and Privileged execution mode

Applicability

This command was introduced before OcNOS version 1.3.

Example

The following is a sample output from the **show ip interface brief** command:

```
#show ip interface brief

'*' - address is assigned by dhcp client

Interface          IP-Address      Admin-Status    Link-Status
eth0                *10.10.26.101   up              up
lo                  127.0.0.1       up              up
lo.management       127.0.0.1       up              up
xe1/1               10.1.1.1        up              up
xe1/2               unassigned      down            down
xe1/3               unassigned      down            down
xe1/4               unassigned      down            down
xe2                 unassigned      up              down
xe3/1               unassigned      up              up
xe3/2               unassigned      down            down
xe3/3               unassigned      down            down
```

Here is the explanation of the show command output fields.

Table 104. show ip interface output details

Field	Description
Interface	Interface name, also specifies interface type (eth0, lo, xe1/1, and xe1/2).
IP-Address	The IP address assigned to the interface. An asterisks indicates that the IP address was provided by DHCP ¹ .
Admin-Status	Interface is up and functioning or down.
Link-Status	Interface is connected and passing traffic.

¹Dynamic Host Configuration Protocol

show ip prefix-list

Use this command to display the prefix list entries for IPv4 interfaces.

Command Syntax

```
show ip prefix-list
show ip prefix-list WORD
show ip prefix-list WORD seq <1-4294967295>
show ip prefix-list WORD A.B.C.D/M
show ip prefix-list WORD A.B.C.D/M longer
show ip prefix-list WORD A.B.C.D/M first-match
show ip prefix-list summary
show ip prefix-list summary WORD
show ip prefix-list detail
show ip prefix-list detail WORD
```

Parameters

WORD

Name of a prefix list.

A.B.C.D/M

IP prefix <network>/<length> (for example, 35.0.0.0/8).

first-match

First matched prefix.

longer

Lookup longer prefix.

<1-4294967295>

Sequence number.

detail

Detail of prefix lists.

summary

Summary of prefix lists.

Default

None

Command Mode

Privileged execution mode

Applicability

This command was introduced before OcNOS version 1.3.

Example

The following is a sample output of the **show ip prefix-list** command showing prefix-list entries.

```
#show ip prefix-list
ip prefix-list myPrefixList: 3 entries
```

```
seq      5 permit 172.1.1.0/16
seq     10 permit 173.1.1.0/16
seq     15 permit 174.1.1.0/16
```

show ip route

Use this command to display the IP routing table for a protocol or from a particular table.

When multiple entries are available for the same prefix, NSM uses an internal route selection mechanism based on protocol administrative distance and metric values to choose the best route. All best routes are entered into the FIB and can be viewed using this command. To display all routes (selected and not selected), use the **show ip route database** command.

Use this command to see all subnets of a specified network if they are present in the routing table. Use this command with mask information.

Command Syntax

```
show ip route A.B.C.D
show ip route (database|)
show ip route (database|) (bgp|connected|database|isis|fast-
reroute|interface|isis|kernel|mbgp|mstatic|next-hop|ospf|rip|static)
show ip route summary
show ip route vrf WORD (database|)
show ip route vrf WORD (database|) (bgp|connected|isis|kernel|ospf|rip|static)
```

Parameters

A.B.C.D

Network in the IP routing table.

A.B.C.D/M

IP prefix <network>/<length>, for example, 35.0.0.0/8.

bgp

Border Gateway Protocol.

connected

Connected.

database

Routing table database.

fast-reroute

Fast reroute repair paths.

interface

Interface.

isis

IS-IS.

kernel

Kernel.

mbgp

Multiprotocol BGP routes.

mstatic

Multicast static routes.

next-hop

Next hop address.

ospf

Open Shortest Path First.

rip

Routing Information Protocol.

static

Static routes.

summary

Summarize all routes.

WORD

Routes for a Virtual Routing or Forwarding instance.

Default

None

Command Mode

Execution mode and Privileged execution mode

Applicability

This command was introduced before OcNOS version 1.3.

Example**Display FIB Routes**

The following shows output for the best routes.

```
#show ip route
Codes: K - kernel, C - connected, S - static, R - RIP, B - BGP
       O - OSPF, IA - OSPF inter area
       N1 - OSPF NSSA external type 1, N2 - OSPF NSSA external type 2
       E1 - OSPF external type 1, E2 - OSPF external type 2
       i - IS-IS, L1 - IS-IS level-1, L2 - IS-IS level-2, ia - IS-IS inter area     E - EVPN,
v - vrf leaked
       * - candidate default
```

show ip route A.B.C.D/M longer-prefixes

Use this command to see all subnets of a specified network if they are present in the routing table with mask information.

Command Syntax

```
show ip route A.B.C.D/M longer-prefixes
```

Parameters

A.B.C.D/M
IP prefix

Default

None

Command Mode

Execution mode and Privileged execution mode

Applicability

This command was introduced in OcNOS version 1.3.6.

Example

```
#sh ip route
Codes: K - kernel, C - connected, S - static, R - RIP, B - BGP
O - OSPF, IA - OSPF inter area
N1 - OSPF NSSA external type 1, N2 - OSPF NSSA external type 2
E1 - OSPF external type 1, E2 - OSPF external type 2
i - IS-IS, L1 - IS-IS level-1, L2 - IS-IS level-2,
ia - IS-IS inter area, E - EVPN,
v - vrf leaked

- candidate default

IP Route Table for VRF "default"
C    10.1.1.0/24 is directly connected, eth1, 00:00:23
C    10.12.41.0/24 is directly connected, eth0, 00:00:23
S    55.0.0.0/8 [1/0] is directly connected, eth1, 00:00:23
S    55.0.0.0/12 [1/0] is directly connected, eth1, 00:00:23
S    55.0.0.0/24 [1/0] is directly connected, eth1, 00:00:23
S    55.1.0.0/16 [1/0] is directly connected, eth1, 00:00:23
S    55.1.1.0/24 [1/0] is directly connected, eth1, 00:00:23
C    127.0.0.0/8 is directly connected, lo, 00:00:23

Gateway of last resort is 10.30.0.11 to network 0.0.0.0

K*   0.0.0.0/0 via 10.30.0.11, eth0
O    9.9.9.9/32 [110/31] via 10.10.31.16, eth2, 00:18:56
K    10.10.0.0/24 via 10.30.0.11, eth0
C    10.10.31.0/24 is directly connected, eth2
S    10.10.34.0/24 [1/0] via 10.10.31.16, eth2
O    10.10.37.0/24 [110/11] via 10.10.31.16, eth2, 00:20:54
```

```
C    10.30.0.0/24 is directly connected, eth0
S    11.22.11.0/24 [1/0] via 10.10.31.16, eth2
O E2 14.5.1.0/24 [110/20] via 10.10.31.16, eth2, 00:18:56
S    16.16.16.16/32 [1/0] via 10.10.31.16, eth2
O    17.17.17.17/32 [110/31] via 10.10.31.16, eth2, 00:20:54
C    45.45.45.45/32 is directly connected, lo
O    55.55.55.55/32 [110/21] via 10.10.31.16, eth2, 00:20:54
C    127.0.0.0/8 is directly connected, lo

#sh ip route 55.0.0.0/7 longer-prefixes
Routing entry for 55.0.0.0/8
Known via "static", distance 1, metric 0, External Route Tag: 0, best

    directly connected, eth1

Routing entry for 55.0.0.0/12
Known via "static", distance 1, metric 0, External Route Tag: 0, best

    directly connected, eth1

Routing entry for 55.0.0.0/24
Known via "static", distance 1, metric 0, External Route Tag: 0, best

    directly connected, eth1

Routing entry for 55.1.0.0/16
Known via "static", distance 1, metric 0, External Route Tag: 0, best

    directly connected, eth1

Routing entry for 55.1.1.0/24
Known via "static", distance 1, metric 0, External Route Tag: 0, best

    directly connected, eth1

#sh ip route 55.0.0.0/8 longer-prefixes
Routing entry for 55.0.0.0/8
Known via "static", distance 1, metric 0, External Route Tag: 0, best

    directly connected, eth1

Routing entry for 55.0.0.0/12
Known via "static", distance 1, metric 0, External Route Tag: 0, best

    directly connected, eth1

Routing entry for 55.0.0.0/24
Known via "static", distance 1, metric 0, External Route Tag: 0, best

    directly connected, eth1

Routing entry for 55.1.0.0/16
Known via "static", distance 1, metric 0, External Route Tag: 0, best

    directly connected, eth1

Routing entry for 55.1.1.0/24
Known via "static", distance 1, metric 0, External Route Tag: 0, best

    directly connected, eth1

#sh ip route 55.0.0.0/11 longer-prefixes
Routing entry for 55.0.0.0/12
Known via "static", distance 1, metric 0, External Route Tag: 0, best

    directly connected, eth1

Routing entry for 55.0.0.0/24
```

```

Known via "static", distance 1, metric 0, External Route Tag: 0, best
    directly connected, eth1

Routing entry for 55.1.0.0/16
Known via "static", distance 1, metric 0, External Route Tag: 0, best
    directly connected, eth1

Routing entry for 55.1.1.0/24
Known via "static", distance 1, metric 0, External Route Tag: 0, best
    directly connected, eth1

#sh ip route 55.0.0.0/16 longer-prefixes
Routing entry for 55.0.0.0/24
Known via "static", distance 1, metric 0, External Route Tag: 0, best
    directly connected, eth1

#sh ip route 55.1.0.0/16 longer-prefixes
Routing entry for 55.1.0.0/16
Known via "static", distance 1, metric 0, External Route Tag: 0, best
    directly connected, eth1

Routing entry for 55.1.1.0/24
Known via "static", distance 1, metric 0, External Route Tag: 0, best
    directly connected, eth1

#sh ip route 55.1.0.0/20 longer-prefixes
Routing entry for 55.1.1.0/24
Known via "static", distance 1, metric 0, External Route Tag: 0, best
    directly connected, eth1

#sh ip route 55.1.0.0/24 longer-prefixes
% Network not in table

#sh ip route 55.1.1.0/24 longer-prefixes
Routing entry for 55.1.1.0/24
Known via "static", distance 1, metric 0, External Route Tag: 0, best
    directly connected, eth1

```

Header

Each entry in this table has a code preceding it, indicating the source of the routing entry. For example, O indicates OSPF as the origin of the route and K indicates that the route has been learned from the kernel. The [Table 105. route codes and modifiers \(page 1646\)](#) table shows these codes and modifiers and explain the fields in the command output.

Table 105. route codes and modifiers

Code	Meaning	Description
K	kernel	Routes added through means other than by using the CLI; for example by using the operating system route command. Static routes added using kernel commands and static routes added using OcnOS commands are different. The kernel static routes are not redistributed when you give the redistribute static command in a protocol. However, the kernel static routes can

Table 105. route codes and modifiers (continued)

Code	Meaning	Description
		be redistributed using the <code>redistribute kernel</code> command.
C	connected	<p>Routes directly connected to the local device that were not distributed via IGP. The device inherently knows of these networks, so there is no need to learn about these from another device.</p> <p>Connected routes are preferred over routes for the same network learned from other routing protocols.</p> <p>Routes for connected networks always exist in the kernel routing table but as an exception are not marked as kernel routes because OcNOS always calculates entries for these routes upon learning interface information from the kernel.</p>
S	static	Routes manually configured via CLI which are not updated dynamically by IGP.
The codes below are for routes received and dynamically learned via IGP neighbors. These networks are not directly connected to this device and were announced by some other device on the network. IGPs update these routes as the network topology changes.		
R	RIP	RIP routing process and enter Router mode.
B	BGP	Route is from an Border Gateway Protocol.
O	OSPF	<p>Modifiers for OSPF:</p> <p>IA - OSPF inter area</p> <p>N1 - OSPF NSSA external type 1</p> <p>N2 - OSPF NSSA external type 2</p> <p>E1 - OSPF external type 1</p> <p>E2 - OSPF external type 2</p>
i	IS-IS	<p>Modifiers for IS-IS:</p> <p>L1 - IS-IS level-1</p> <p>L2 - IS-IS level-2</p> <p>ia - IS-IS inter area</p>
Other modifiers:		
v	vrf leaked	The device has two or more VRFs configured and each has at least one interface bound to it. While each VRF ¹ will have its own routing table, the VRFs can learn each other's routes.
*	candidate default	Route has been added to the FIB. With equal cost paths to a destination, the router does per-packet or per-destination load sharing. An asterisk ("*") means that the route is being used at that instant for forwarding packets. If you run the same <code>show ip route x.x.x.x</code> command over and over, you might see the * moving between the route entries.
>	selected route	<p>When multiple routes are available for the same prefix, the best route.</p> <p>When multiple entries are available for the same prefix, OcNOS uses an internal route selection mechanism based on protocol administrative distance and metric values to</p>

¹Virtual Routing and Forwarding

Table 105. route codes and modifiers (continued)

Code	Meaning	Description
		choose the best route. OcNOS populates the FIB with the <i>best</i> route to each destination
p	stale info	A route information that is marked stale due to graceful restart.

After the codes, the header has default gateway information:

```
Gateway of last resort is 10.12.4.1 to network 0.0.0.0
```

The “gateway of last resort”, also called the default gateway, is a static route that routes IP address 0.0.0.0 (all destinations) through a single host (the gateway). The effect of setting a gateway is that if no routing table entry exists for a destination address, packets to that address will be forwarded to the gateway router.

Route Entry Fields

The [Table 106. route entry output details \(page 1648\)](#) table explains the each route entry fields.

Table 106. route entry output details

Field	Description
Codes and modifiers	As explained in Table 105. route codes and modifiers (page 1646) table.
IP address	IP address of the remote network.
Administrative distance and metric	The administrative distance determines how trustworthy this route is. If there is a similar route but with a smaller administrative distance, it is used instead, because it is more “trustworthy”. The smaller the administrative distance, the more trustworthy the route. Directly connected routes have an administrative distance of 0, which makes them the most trustworthy type of route. The metric varies from protocol to protocol, and for OSPF the metric is cost, which indicates the best quality path to use to forward packets. Other protocols, like RIP, use hop count as a metric. For neighboring routers, the metric value is 1.
Next hop router IP address	This route is available through the next hop router located at this IP address. This identifies exactly where packets go when they match this route.
Outgoing interface name	Interface used to get to the next-hop address for this route.
Duration	Length of time that this route has been present in the routing table. This is also the length of time this route has existed without an update. If the route were removed and then re-added (if the cable was disconnected, for instance), this timer would begin again at 00:00:00.

Route Entry Examples

```
O 10.10.37.0/24 [110/11] via 10.10.31.16, eth2, 00:20:54
```

- This route in the network 10.10.37.0/24 was added by OSPF.
- This route has an administrative distance of 110 and metric/cost of 11.
- This route is reachable via nexthop 10.10.31.16.
- The outgoing local interface for this route is eth2.
- This route was added 20 minutes and 54 seconds ago.

```
O E2 14.5.1.0/24 [110/20] via 10.10.31.16, eth2, 00:18:56
```

- This route is the same as the other OSPF route above; the only difference is that it is a Type 2 External OSPF route.

C 10.10.31.0/24 is directly connected, eth2

- This route is directly connected.
- Route entries for network 10.10.31.0/24 are derived from the IP address of local interface eth2.

K 10.10.0.0/24 via 10.30.0.11, eth0

- This route in the network 10.10.0.0/24 was learned from the kernel routing table (route was statically added using kernel commands).
- This route is reachable via nexthop 10.30.0.11.
- The outgoing local interface for this route is eth0.

K* 0.0.0.0/0 via 10.30.0.11, eth0

- This is a default route that was learned from the kernel (route was statically added using kernel commands).
- This route is reachable via nexthop 10.30.0.11.
- The local interface for this route is eth0.

Display OSPF Routes

The following is the output with the `ospf` parameter:

```
#show ip route ospf
O      1.1.1.0/24 [110/20] via 2.2.2.1, eth2, 00:00:44
O IA   4.4.4.0/24 [110/21] via 2.2.2.1, eth2, 00:00:44
```

Display Route Summary

The following is the output with the `summary` parameter.

```
#show ip route summary
IP routing table name is Default-IP-Routing-Table(0)
IP routing table maximum-paths is 4
Route Source      Networks
kernel            1
connected         5
ospf               2
Total             8
FIB                2
```

Display RIB Routes

The following shows displaying database routes.

```
#show ip route database
Codes: K - kernel, C - connected, S - static, R - RIP, B - BGP
O - OSPF, IA - OSPF inter area
N1 - OSPF NSSA external type 1, N2 - OSPF NSSA external type 2
E1 - OSPF external type 1, E2 - OSPF external type 2
i - IS-IS, L1 - IS-IS level-1, L2 - IS-IS level-2, ia - IS-IS inter area
> - selected route, * - FIB route, p - stale info

K  *> 0.0.0.0/0 via 10.30.0.11, eth0
O  *> 9.9.9.9/32 [110/31] via 10.10.31.16, eth2, 00:19:21
K  *> 10.10.0.0/24 via 10.30.0.11, eth0
O      10.10.31.0/24 [110/1] is directly connected, eth2, 00:28:20
C  *> 10.10.31.0/24 is directly connected, eth2
```



```

S  *> 10.10.34.0/24 [1/0] via 10.10.31.16, eth2
O   10.10.34.0/24 [110/31] via 10.10.31.16, eth2, 00:21:19
O  *> 10.10.37.0/24 [110/11] via 10.10.31.16, eth2, 00:21:19
K  * 10.30.0.0/24 is directly connected, eth0
C  *> 10.30.0.0/24 is directly connected, eth0
S  *> 11.22.11.0/24 [1/0] via 10.10.31.16, eth2
O E2 *> 14.5.1.0/24 [110/20] via 10.10.31.16, eth2, 00:19:21
O   16.16.16.16/32 [110/11] via 10.10.31.16, eth2, 00:21:19
S  *> 16.16.16.16/32 [1/0] via 10.10.31.16, eth2
O  *> 17.17.17.17/32 [110/31] via 10.10.31.16, eth2, 00:21:19
C  *> 45.45.45.45/32 is directly connected, lo
O  *> 55.55.55.55/32 [110/21] via 10.10.31.16, eth2, 00:21:19
K  * 127.0.0.0/8 is directly connected, lo
C  *> 127.0.0.0/8 is directly connected, lo

```

The codes and modifier at the start of each route entry are explained in [Table 105. route codes and modifiers \(page 1646\)](#) table.

Routes in the FIB are marked with a *. When multiple routes are available for the same prefix, the best route is indicated with the > symbol. Unselected routes have neither the * nor the > symbol.

Route Database Entry Examples

This example shows 2 entries in the route database; one learned from the kernel and the other derived from interface information.

```

K * 10.30.0.0/24 is directly connected, eth0
C *> 10.30.0.0/24 is directly connected, eth0

```

- Both these routes are in the same network 10.30.0.0/24.
- The first route has originated from the kernel. The * indicates that it has been added to the FIB.
- The second route is derived from the IP address of local interface eth0. It is marked as a connected route. Since a connected route has the lowest administrative distance, it is the selected route.

```

S *> 10.10.34.0/24 [1/0] via 10.10.31.16, eth2
O 10.10.34.0/24 [110/31] via 10.10.31.16, eth2, 00:21:19

```

- The same prefix was learned from OSPF and from static route configuration.
- Static routes are preferred over OSPF routes, so the static route is selected and installed in the FIB.



Note: If the static route becomes unavailable, OcnOS automatically selects the OSPF route and installs it in the FIB.

Display VRF Routes

The following is the output with the **vrf** parameter:

```

#show ip route vrf vrf31
Codes: K - kernel, C - connected, S - static, R - RIP, B - BGP
O - OSPF, IA - OSPF inter area
N1 - OSPF NSSA external type 1, N2 - OSPF NSSA external type 2
E1 - OSPF external type 1, E2 - OSPF external type 2
i - IS-IS, L1 - IS-IS level-1, L2 - IS-IS level-2,
ia - IS-IS inter area, E - EVPN,
v - vrf leaked
* - candidate default

IP Route Table for VRF "vrf31"
O      2.2.2.2/32 [110/2] via 21.1.1.2, vlan1.4, 00:01:29
O      10.1.1.0/24 [110/2] via 21.1.1.2, vlan1.4, 00:01:29

```

```
O      20.1.1.0/24 [110/2] via 21.1.1.2, vlan1.4, 00:01:29
C      21.1.1.0/24 is directly connected, vlan1.4, 00:02:54
C      31.31.1.1/32 is directly connected, lo.vrf31, 00:03:02
O      40.40.1.1/32 [110/3] via 21.1.1.2, vlan1.4, 00:00:43
C      127.0.0.0/8 is directly connected, lo.vrf31, 00:03:05
```

Gateway of last resort is not set

The following is the output with the **vrf database** parameter:

```
#show ip route vrf vrf31 database
Codes: K - kernel, C - connected, S - static, R - RIP, B - BGP
O - OSPF, IA - OSPF inter area
N1 - OSPF NSSA external type 1, N2 - OSPF NSSA external type 2
E1 - OSPF external type 1, E2 - OSPF external type 2
i - IS-IS, L1 - IS-IS level-1, L2 - IS-IS level-2,
ia - IS-IS inter area, E - EVPN,
v - vrf leaked
> - selected route, * - FIB route, p - stale info

IP Route Table for VRF "vrf31"
O      *> 2.2.2.2/32 [110/2] via 21.1.1.2, vlan1.4, 00:01:32
O      *> 10.1.1.0/24 [110/2] via 21.1.1.2, vlan1.4, 00:01:32
O      *> 20.1.1.0/24 [110/2] via 21.1.1.2, vlan1.4, 00:01:32
C      *> 21.1.1.0/24 is directly connected, vlan1.4, 00:02:57
O      21.1.1.0/24 [110/1] is directly connected, vlan1.4, 00:02:57
C      *> 31.31.1.1/32 is directly connected, lo.vrf31, 00:03:05
O      31.31.1.1/32 [110/1] is directly connected, lo.vrf31, 00:03:00
O      *> 40.40.1.1/32 [110/3] via 21.1.1.2, vlan1.4, 00:00:46
B      > 50.1.1.0/24 [200/0] via 41.41.41.41, 00:00:18
C      *> 127.0.0.0/8 is directly connected, lo.vrf31, 00:03:08
```

Gateway of last resort is not set

show ip vrf

This command displays routing information about VRFs.

Command Syntax

```
show ip vrf
show ip vrf WORD
```

Parameters

WORD

Virtual Routing and Forwarding name.

Default

None

Command Mode

Execution mode and Privileged execution mode

Applicability

This command was introduced before OcNOS version 1.3.

Example

```
#show ip forwarding
vrf (management) :IP forwarding is on
vrf (default) :IP forwarding is on
```

show ipv6 forwarding

Use this command to display the IPv6 forwarding status.

Command Syntax

```
show ipv6 forwarding
```

Parameters

None

Default

None

Command Mode

Execution mode and Privileged execution mode

Applicability

This command was introduced before OcNOS version 1.3.

Example

The following is a sample output of the **show ipv6 forwarding** command displaying the IPv6 forwarding status.

```
#show ipv6 forwarding
vrf (management) :IPv6 forwarding is on
vrf (default) :IPv6 forwarding is on
```

show ipv6 interface brief

Use this command to display information about interfaces. To display information about a specific interface, include the interface name.

Command Syntax

```
show ipv6 interface brief
show ipv6 interface IFNAME brief
```

Parameters

IFNAME

Name of the interface.

Default

None

Command Mode

Execution mode and Privileged execution mode

Applicability

This command was introduced before OcNOS version 1.3.

Example

```
#show ipv6 interface brief
Interface          IPv6-Address          Admin-Status
lo                 ::1                   [up/up]

gre0               unassigned            [admin down/down]

eth3               3ffe:abcd:104::1     [up/up]
                  3ffe:abcd:103::1
                  fe80::2e0:29ff:fe6f:cf0

eth1               fe80::260:97ff:fe20:f257 [up/up]

eth2               unassigned            [admin down/down]

eth3               unassigned            [admin down/down]

sit0               unassigned            [admin down/down]

tun24              unassigned            [admin down/down]

tun10              unassigned            [admin down/down]
```

The table below explains the each interface brief entry.

Table 107. show interface brief output details

Field	Description
Interface	Name of the interface.
IPv6-Address	IPv6 address. An asterisk (“*”) means the address was assigned by the DHCPv6 client.
Admin-Status	Status of the interface: The first part of the field indicates if the interface is up. The second part indicates if the interface is running.

show ipv6 route

Use this command to display the IP routing table for a protocol or from a particular table, including database entries known by NSM. When multiple entries are available for the same prefix, NSM uses an internal route selection mechanism based on protocol administrative distance and metric values to choose the best route. The best routes in the FIB can be viewed using **show ipv6 route**.

Command Syntax

```
show ipv6 route vrf WORD (database|)
show ipv6 route vrf WORD (database|) (bgp|connected|isis|kernel|ospf|rip|static)
show ipv6 route (database)
show ipv6 route (database) (bgp|connected|isis|kernel|ospf|rip|static)
show ipv6 route X:X::X:X
show ipv6 route X:X::X:X/M
show ipv6 route summary
```

Parameters

X:X::X:X

Network in the IP routing table.

X:X::X:X/M

Prefix <network>/<length>, e.g., 35.0.0.0/8

all

All IPv6 routes

bgp

Border Gateway Protocol.

connected

Connected.

database

IPv6 routing table database.

isis

IS-IS.

IFNAME

Interface name

kernel

Kernel.

ospf

Open Shortest Path First.

rip

Routing Information Protocol.

static

Static routes.

summary

Summarize all routes

WORD

Routes from a Virtual Routing and Forwarding instance

Default

None

Command Mode

Execution mode and Privileged execution mode

Applicability

This command was introduced before OcNOS version 1.3.

Examples

See [Table 105. route codes and modifiers \(page 1646\)](#) and [Table 106. route entry output details \(page 1648\)](#) tables for an explanation of the codes and fields in the output.

```
#show ipv6 route
Codes: K - kernel route, C - connected, S - static, R - RIPng, O - OSPFv3,
       I - IS-IS, B - BGP, > - selected route, * - FIB route, p - stale info.
C> * ::1/128 is directly connected, lo
C> * 3ffe:1::/48 is directly connected, eth1
C> * 3ffe:2:2::/48 is directly connected, eth2
```

show ipv6 prefix-list

Use this command to display the prefix list entries for IPv6 interfaces.

Command Syntax

```
show ipv6 prefix-list
show ipv6 prefix-list WORD
show ipv6 prefix-list WORD seq <1-4294967295>
show ipv6 prefix-list WORD X:X::X:X/M
show ipv6 prefix-list WORD X:X::X:X/M longer
show ipv6 prefix-list WORD X:X::X:X/M first-match
show ipv6 prefix-list summary
show ipv6 prefix-list summary WORD
show ipv6 prefix-list detail
show ipv6 prefix-list detail WORD
```

Parameters

WORD

Name of prefix list.

X:X::X:X/M

IP prefix <network>/<length> (for example, 35.0.0.0/8).

first-match

First matched prefix.

longer

Look up longer prefix.

<1-4294967295>

Sequence number of an entry.

detail

Detail of prefix lists.

summary

Summary of prefix lists.

Default

None

Command Mode

Privileged execution mode

Applicability

This command was introduced before OcNOS version 1.3.

Example

The following is a sample output of the **show ip prefix-list** command showing prefix-list entries.

```
#show ip prefix-list
ip prefix-list myPrefixList: 3 entries
```

```
seq      5 permit 172.1.1.0/16
seq     10 permit 173.1.1.0/16
seq     15 permit 174.1.1.0/16
```

show hosts

Use this command to display the IP domain-name, lookup style and any name server.

Command Syntax

```
show hosts
```

Parameters

None

Default

None

Command Mode

Execution mode and Privileged execution mode

Applicability

This command was introduced before OcNOS version 1.3.

Example

```
#show hosts
      VRF: management
DNS lookup is enabled
  Default domain      : .com
  Additional Domain   : .in .ac
  Name Servers        : 10.12.3.23
Host                  Address
----                -
test                  10.12.12.67
test                  10::23
* - Values assigned by DHCP Client.
```

Here is the explanation of the show command output fields.

Table 108. show hosts fields

Entry	Description
VRF ¹ : management	DNS configuration of specified VRF
DNS lookup is enabled	DNS feature enabled or disabled
Default domain	Default domain name used to complete unqualified host names (names without a dotted decimal domain name).
Additional Domain	A list of default domain names used to complete unqualified host names. Each domain in the list is to be tried in turn.

¹Virtual Routing and Forwarding

Table 108. show hosts fields (continued)

Entry	Description
Name Servers	DNS server addresses that are used to translate hostnames to IP addresses.
Host Address test 10.12.12.67 test 10::23	Static hostname-to-address mappings in DNS.
* - Values assigned by DHCP ¹ Client.	* in name-server indicates it has been learned dynamically.

¹Dynamic Host Configuration Protocol

show running-config interface

Use this command to show the running system status and configuration for a specified interface, or a specified interface for a specified protocol.

Command Syntax

```
show running-config interface IFNAME
show running-config interface IFNAME bridge
show running-config interface IFNAME ip igmp
show running-config interface IFNAME ip multicast
show running-config interface IFNAME ip pim
show running-config interface IFNAME ipv6 ospf
show running-config interface IFNAME ipv6 rip
show running-config interface IFNAME ipv6 pim
show running-config interface IFNAME isis
show running-config interface IFNAME lacp
show running-config interface IFNAME mstp
show running-config interface IFNAME ospf
show running-config interface IFNAME ptp
show running-config interface IFNAME rip
show running-config interface IFNAME rstp
show running-config interface IFNAME stp
show running-config interface IFNAME synce
```

Parameter

bridge

Bridge.

ip

IPv4 (see also [show running-config interface ip \(page 1664\)](#)).

ipv6

IPv6 (see also [show running-config interface ipv6 \(page 1665\)](#)).

isis

Intermediate System to Intermediate System.

lacp

Link Aggregation Control Protocol.

mstp

Multiple Spanning Tree Protocol.

ospf

Open Shortest Path First.

ptp

Precision Time Protocol.

rip

Routing Information Protocol.

rstp

Rapid Spanning Tree Protocol.

stp

Spanning Tree Protocol.

synce

Synchronous Ethernet.

Default

None

Command Mode

Privileged execution mode and Configure mode

Applicability

This command was introduced before OcNOS version 1.3.

Example

```
#show running-config interface eth1 bridge
!
interface eth1
  switchport
  bridge-group 1
  switchport mode access
  user-priority 3
  traffic-class-table user-priority 2 num-traffic-classes 3 value 3 traffic-class-table user-priority
7 num-traffic-classes 1 value 2 traffic-class-table user-priority 7 num-traffic-classes 2 value 0
traffic-class-table user-priority 7 num-traffic-classes 3 value 0 traffic-class-table user-priority 7
num-traffic-classes 4 value 0 traffic-class-table user-priority 7 num-traffic-classes 5 value 0
traffic-class-table user-priority 7 num-traffic-classes 6
```

show running-config interface ip

Use this command to show the running system status and configuration for a specified IP.

Command Syntax

```
show running-config interface IFNAME ip (igmp|multicast|pim|)
```

Parameters

IFNAME

Interface name.

igmp

Internet Group Management Protocol.

multicast

Multicast.

pim

Protocol Independent Multicast.

Default

None

Command Mode

Privileged execution mode

Applicability

This command was introduced before OcNOS version 1.3.

Example

```
#show running-config interface eth1 ip igmp
!
interface eth1
 switchport
```

show running-config interface ipv6

Use this command to show the running system status and configuration for a specified IPv6 protocol.

Command Syntax

```
show running-config interface IFNAME ipv6 (mld|multicast|ospf|pim|rip|)
```

Parameters

IFNAME

Interface name.

mld

Multicast Listener Discovery

multicast

Multicast

ospf

Open Shortest Path First

pim

Protocol Independent Multicast

rip

Routing Information Protocol

Default

None

Command Mode

Privileged execution mode

Applicability

This command was introduced before OcNOS version 1.3.

Example

```
#show running-config interface eth1 ipv6 rip
!
interface eth1
  switchport
```

show running-config ip

Use this command to show the running system of IP configurations.

Command Syntax

```
show running-config ip (dhcp|mroute|route)
```

Parameters

dhcp

Dynamic Host Configuration Protocol.

mroute

Static IP multicast route.

route

Static IP route.

Default

None

Command Mode

Privileged execution mode

Applicability

This command was introduced before OcNOS version 1.3.

Example

```
>enable
#show running-config ip route
!
ip route 3.3.3.3/32 eth3
ip route 3.3.3.3/32 eth2
ip route 200.0.0.0/16 lo
!
```

show running-config ipv6

Use this command to show the running system status and configuration for IPv6.

Command Syntax

```
show running-config ipv6 (access-list|mroute|neighbor|prefix-list|route|)
```

Parameters

access-list

Access list.

mroute

Static IPv6 Multicast route.

neighbor

Static IPv6 neighbor entry.

prefix-list

IPv6 prefix-list.

route

Static IPv6 route.

Default

None

Command Mode

Privileged execution mode

Applicability

This command was introduced before OcNOS version 1.3.

Example

```
>enable
#show running-config ipv6 access-list
!
ipv6 access-list abc permit any
!
#show running-config ipv6 prefix-list
!
ipv6 prefix-list sde
  seq 5 permit any
!
#show running-config ipv6 route
!
ipv6 route 3e11::/64 lo
ipv6 route 3e11::/64 eth2
ipv6 route fe80::/64 eth2
!
```

show running-config prefix-list

Use this command to display the running system status and configuration details for prefix lists.

Command Syntax

```
show running-config prefix-list
```

Parameters

None

Default

None

Command Mode

Privileged execution mode, Configure mode, Route map mode

Applicability

This command was introduced before OcNOS version 1.3.

Example

```
>enable
(config)#show running-config prefix-list
!
ip prefix-list abc
  seq 5 permit any
!
ip prefix-list as
  description annai
!
ip prefix-list wer
  seq 45 permit any
!
(config)#
```

shutdown

Use this command to shut down an interface.

Use the `no` form of this command to bring up an interface.

Command Syntax

```
shutdown
no shutdown
```

Parameters

None

Default

None

Command Mode

Interface mode

Applicability

This command was introduced before OcNOS version 1.3.

Examples

The following example shows the use of the `shutdown` command to shut down the interface called `eth3`.

```
#configure terminal
(config)#interface eth3
(config-if)#shutdown
```

speed

Use this command to set the link speed of the interface.

Use the `no` parameter to reset the speed to its default value.

- On copper ports, auto-negotiation is enabled by default. Limited auto-negotiation is also supported, allowing users to advertise a specific speed for an interface. For example, user can configure an interface to auto-negotiate only with a 100m peer.
- On fiber optic ports, auto-negotiation is disabled by default. Auto-negotiation is not supported on fiber optic medium or AOC for speeds 10g and beyond. IP Infusion Inc. does not recommend using auto speed on such transceivers. For DAC cables, both force and auto-negotiation are supported.
- IP Infusion Inc. recommends configuring the same speed mode on both peers.
- When user configure an interface with the speed auto option, the negotiated parameters are speed, [duplex \(page 1572\)](#), [flowcontrol \(page 1575\)](#), and [fec \(page 1573\)](#), each configured separately. Refer to the respective command for details.



Notes:

- For 10g DAC or AOC, setting speed auto negotiates with a maximum of 1G.
- Interface speed setting is only supported on physical front-panel ports and not supported on Management interface `eth0`.
- Configuring or unconfiguring speed will reset **FEC**¹ to auto mode.

The [Table 109. Recommendations \(page 1670\)](#) shows the IP Infusion Inc. recommendations for front-panel port speed and transceivers.

Table 109. Recommendations

Supported/Recommended	Explanation
Not Supported	When the front panel port capability is less than the transceiver's capability, the behavior is undefined.
Not Recommended	When the transceiver's capability matches the front panel port capability, reducing the speed is not recommended.
Recommended	When the transceiver's capability is less than the front panel port capability, the behavior is undefined, and the link might still come up. Set the speed to match the transceiver's capability.

The table below shows examples of front-panel configurations:

¹FEC is a technique that detects and corrects errors during data transmission to maintain the reliability of the communication system.

Table 110. Front-panel configurations

Front Panel Port	Explanation
Front Panel Port 100g	Use the speed 40g command with 40g transceivers. IP Infusion Inc. does not recommend to use 40g on 100g speed transceivers.
Front Panel Port 40g	Do not use 100g transceivers.
Front Panel Port 25g	Use the port-group command to reduce the speed to 10g when using 10g transceivers. IP Infusion Inc. does not recommend to use 10g on 25g speed transceivers. Set the speed to 1g when using 1g transceivers. Below 25g, port speed can vary (10g or 1g) for ports within the same port group, e.g., one port can have 1g while the remaining have 10g. However, one port at 25g and the rest at 10g is not allowed. Using the no speed command at the interface level tries to set the speed to 25g for one port in the port-group while others may be at 10g or 1g, which is not allowed. Use the no port-group command in such cases.
Front Panel Port 10g	Do not use 25g transceivers. Set the speed to 1g when using 1g transceivers.
Front Panel Port 1g	Do not use 10g or 25g transceivers..

Command Syntax

```
speed (10m | 100m | 1g | 2.5g | 10g | 20g | 25g | 40g | 50g | 100g | auto (10m | 100m | 1g) )
no speed
```

Parameters

10m

Set the speed to 10 megabits per second.

100m

Set the speed to 100 megabits per second.

1g

Set the speed to 1 gigabit per second.

2.5g

Set the speed to 2.5 gigabits per second.

10g

Set the speed to 10 gigabits per second.

20g

Set the speed to 20 gigabits per second.

25g

Set the speed to 25 gigabits per second.

40g

Set the speed to 40 gigabits per second.

50g

Set the speed to 50 gigabits per second.

100g

Set the speed to 100 gigabits per second.

auto 10m

Auto negotiate only with a 10Mb peer

auto 100m

Auto negotiate only with a 100Mb peer

auto 1g

Auto negotiate only with a 1g peer

Default

None

Command Mode

Interface mode

Applicability

Introduced before OcNOS version 1.3 and added parameters **auto 10m**, **auto 100m**, and **auto 1g** in the OcNOS version 6.4.2.

Example

Enable auto-negotiation:

```
#configure terminal
(config)#interface xe0
(config-if)#speed auto 10m
```

switchport

Use this command to set the mode of an interface to switched.

All interfaces are configured **routed** by default. To change the behavior of an interface from switched to routed, you must explicitly give the **noswitchport** command.



Note: When you change the mode of an interface from switched to routed and vice-versa, all configurations for that interface are erased.

User should be prompted for confirmation, while executing **switchport/no switchport** command. To support this requirement, please refer the command **enable/disable confirmation-dialog**.

Use the **no** form of this command to set the mode to routed.

Command Syntax

```
switchport
no switchport
```

Parameters

None

Default

None

Command Mode

Interface mode

Applicability

This command was introduced before OcNOS version 1.3.

Examples

```
#configure terminal
(config)#interface eth0
(config-if)#switchport

(config)#interface eth0
(config-if)#no switchport

#configure terminal
(config)#enable confirmation-dialog
(config)#interface xe5
(config-if)#switchport
Are you sure? (y/n): y
(config-if)#
(config-if)#exit

(config)#disable confirmation-dialog
```



```
(config)#interface xe5  
(config-if)#switchport  
(config-if)#
```

switchport allowed ethertype

Use this command to indicate which types of traffic will be allowed on the switchport.



Note: A maximum of 5 Ethertype values can be assigned on an interface.

Command Syntax

```
switchport allowed ethertype {arp|ipv4|ipv6|ETHATYPE|log}
```

Parameters

arp

ARP traffic

ipv4

IPv4 traffic

ipv6

IPv6 traffic

ETHATYPE

Traffic of any Ethertype value (0x600 - 0xFFFF).

log

Log unwanted ethertype packets.

Default

None

Command Mode

Interface mode

Applicability

This command was introduced before OcNOS version 1.3.

Example

```
(config)#interface xe32/1
(config-if)#switchport
(config-if)#switchport allowed ethertype ipv4
(config-if)#switchport allowed ethertype 0x800
```

switchport protected

Use this command to enable or disable the protected port feature on an interface.

Command Syntax

```
switchport protected (community | isolated | promiscuous)
no switchport protected
```

Parameters

community

Community mode

isolated

Isolated mode type

promiscuous

Protected mode type

Default

Promiscuous

Command Mode

Interface mode

Applicability

This command was introduced in OcNOS version 5.0.

Example

```
#configure terminal
(config)#interface xel
(config-if)#switchport protected isolated
(config-if)#no switchport protected

(config)#interface pol
(config-if)#switchport protected promiscuous
(config-if)#no switchport protected
```

transceiver

Use this command to set the type of Small Form-factor Pluggable (SFP) transceiver inserted in the physical port. Use the `no` form of this command to remove the setting.

Command Syntax

```
transceiver (1000base-sx|1000base-lx|1000base-ex|1000base-cx|10gbase-sr|10gbase-lr|10gbase-er|10gbase-cr|25gbase-sr|25gbase-lr|25gbase-er|25gbase-cr|40gbase-sr4|40gbase-lr4|40gbase-er4|40gbase-cr4|100gbase-sr4|100gbase-lr4|100gbase-er4|100gbase-cr4)
no transceiver
```

Parameters

1000base-cx

SFP 1000base-cx

1000base-ex

SFP 1000base-ex

1000base-lx

SFP 1000base-lx

1000base-sx

SFP 1000base-sx

100gbase-cr4

QSFP28 100gbase-cr4

100gbase-er4

QSFP28 100gbase-er4

100gbase-lr4

QSFP28 100gbase-lr4

100gbase-sr4

QSFP28 100gbase-sr4

10gbase-cr

SFP+ 10gbase-cr

10gbase-er

SFP+ 10gbase-er

10gbase-lr

SFP+ 10gbase-lr

10gbase-sr

SFP+ 10gbase-sr

25gbase-cr

SFP+ 25gbase-cr

25gbase-er

SFP+ 25gbase-er

25gbase-lr

SFP+ 25gbase-lr

25gbase-sr

SFP+ 25gbase-sr

40gbase-cr4

QSFP 40gbase-cr4

40gbase-er4

QSFP 40gbase-er4

40gbase-lr4

QSFP 40gbase-lr4

40gbase-sr4

QSFP 40gbase-sr4

Default

None

Command Mode

Interface mode

Applicability

This command was introduced in OcNOS version 5.0.

Examples

```
(config)#interface ce1/1
(config-if)#transceiver 40gbase-lr4
```

tx cdr-bypass

Use this command to by-pass the transmitter Clock Data Recovery (CDR) on transceivers which supports CDR control and operating at lower speeds than maximum operating speed.

Use the **no** form of this command to disable CDR by-pass.

Command Syntax

```
tx cdr-bypass
```

Parameters

None

Default

None

Command Mode

Interface mode

Applicability

This command was introduced in OcNOS version 6.5.2.

Examples

```
#configure terminal
(config)#interface ce1
(config-if)#tx cdr-bypass
    Bypass the TX CDR control

(config)#interface ce1
(config-if)#no tx cdr-bypass
```

rx cdr-bypass

Use this command to by-pass the receiver Clock Data Recovery (CDR) on transceivers which supports CDR control and operating at lower speeds than maximum operating speed.

Use the no form of this command to disable CDR by-pass

Command Syntax

```
rx cdr-bypass
```

Parameters

None

Default

None

Command Mode

Interface mode

Applicability

This command was introduced in OcNOS version 6.5.2.

Examples

```
#configure terminal
(config)#interface cel
(config-if)#rx cdr-bypass
    Bypass the RX CDR control
(config)#interface cel
(config-if)#no rx cdr-bypass
```

Time Range Commands

This chapter describes the commands used to create and manage time range objects which are used to add a timing boundary for specified activities. The activity starts, ends, and repeats at the specific times that you set.

end-time (absolute)	1682
end-time after (relative)	1684
frequency	1685
frequency days (specific days)	1686
start-time (absolute)	1687
start-time after (relative)	1689
start-time now (current)	1690
time-range	1691

end-time (absolute)

Use this command to set the end time for the time range to an absolute time.

Command Syntax

```
end-time HH:MM <1-31> (january | february | march | april | may | june | july | august | september |  
october | november | december) <1995-2035>
```

Parameters

HH:MM

End time hour and minutes

<1-31>

Day of the month

april

Month of April

august

Month of August

december

Month of December

february

Month of February

january

Month of January

july

Month of July

june

Month of June

march

Month of March

may

Month of May

november

Month of November

october

Month of October

september

Month of September

<1995-2035>

Year

Default

None

Command Mode

Time range mode

Applicability

This command was introduced in OcNOS version 5.0.

Example

```
(config)#time-range TIMER1  
(config-tr)#end-time 10:10 20 february 2021
```

end-time after (relative)

Use this command to set the end time for the time range to a relative time in minutes, from the configured start time.

Command Syntax

```
end-time after <1-129600>
```

Parameters

<1-129600>

Number of minutes from the start time

Default

None

Command Mode

Time range mode

Applicability

This command was introduced in OcNOS version 5.0.

Example

```
(config)#time-range TIMER1  
(config-tr)#end-time after 100
```

frequency

Use this command to set the frequency for the time range.

Command Syntax

```
frequency (daily|hourly|weekly)
```

Parameters

daily

Daily frequency

hourly

Hourly frequency

weekly

Weekly frequency

Default

None

Command Mode

Time range mode

Applicability

This command was introduced in OcNOS version 5.0.

Example

```
(config)#time-range TIMER1  
(config-tr)#frequency hourly
```

frequency days (specific days)

Use this command to set the frequency for the time range to specific days of the week.

Command Syntax

```
frequency days WORD
```

Parameters

WORD

Colon-separated list of 3-letter days of the week for the days on which the range is repeated. For example:

```
mon:tue:wed:thu:fri:sat:sun
```

Default

None

Command Mode

Time range mode

Applicability

This command was introduced in OcNOS version 5.0.

Example

```
(config)#time-range TIMER1
(config-tr)#frequency days mon:wed:fri
(config)#exit
(config)#time-range TIMER2
(config-tr)#frequency days mon:tue:wed:thu:fri:sat:sun
```

start-time (absolute)

Use this command to set the start time for the time range to an absolute time.

Command Syntax

```
start-time HH:MM <1-31> (january | february | march | april | may | june | july | august | september  
| october | november | december) <1995-2035>
```

Parameters

HH:MM

End time hour and minutes

<1-31>

Day of the month

april

Month of April

august

Month of August

december

Month of December

february

Month of February

january

Month of January

july

Month of July

june

Month of June

march

Month of March

may

Month of May

november

Month of November

october

Month of October

september

Month of September

<1995-2035>

Year

Default

None

Command Mode

Time range mode

Applicability

This command was introduced in OcNOS version 5.0.

Example

```
(config)#time-range TIMER1  
(config-tr)#start-time 09:09 20 february 2021
```

start-time after (relative)

Use this command to set the start time for the time range to a relative time in minutes, from the current time.

Command Syntax

```
start-time after <1-129600>
```

Parameters

<1-129600>

Number of minutes from the current time

Default

None

Command Mode

Time range mode

Applicability

This command was introduced in OcNOS version 5.0.

Example

```
(config)#time-range TIMER1  
(config-tr)#start-time after 100
```

start-time now (current)

Use this command to set the start time for the time range to the current system time.

Command Syntax

```
start-time now
```

Parameters

None

Default

None

Command Mode

Time range mode

Applicability

This command was introduced in OcNOS version 5.0.

Example

```
(config)#time-range TIMER1  
(config-tr)#start-time now
```

time-range

Use this command to create a time range and go into the time range mode to configure the time range. If the time range already exists, then it will be edited.

Use the **no** form of this command to remove a time range object.

Command Syntax

```
time-range NAME
no time-range NAME
```

Parameters

NAME

Name of the time range.

Default

None

Command Mode

Configure mode

Applicability

This command was introduced in OcNOS version 5.0.

Example

```
#configure terminal
(config)# time-range TIMER1
```

System Configure Mode Commands

This chapter provides a reference for the system configure mode commands.

delay-profile interfaces	1693
delay-profile interfaces subcommands	1694
forwarding custom-profile	1696
forwarding profile	1698
ip redirects	1700
load-balance enable	1701
hardware-profile filter (XGS)	1704
load-balance rtag7	1706
load-balance rtag7 all-lag-if	1708
load-balance rtag7 hash	1709
load-balance rtag7 macro-flow	1710
show forwarding profile limit	1711
show hardware-profile filters	1713
Linux Shell Commands	1715

delay-profile interfaces

Use this command to go into the delay-profile mode to edit the parameters of the "interfaces" profile. In this mode, the user is able to edit the delay measurement profile parameters.

Command Syntax

```
delay-profile interfaces
```

Parameters

None

Command Mode

Configure mode

Applicability

This command was introduced in OcNOS version 5.1.

Examples

```
#configure terminal
(config)#delay-profile interfaces
(config-dp-intf)#
```

delay-profile interfaces subcommands

The following commands are to edit the delay-profile parameters.



Note: According to IGP-TE RFC8570 and RFC7471, the advertised delay should be unidirectional. So when the mode is set to two-way, the advertised delay is “Average_RTT_delay / 2” and when the mode is set to one-way, the advertised delay is “Average_FWD_delay”. The default value is “two-way”.

Command Syntax

```
mode <two-way>|<one-way>
burst-interval <1000-15000>
burst-count <1-5>
interval < 30-3600>
sender-port <1025-65535>
advertisement periodic
advertisement periodic threshold <1-100>
advertisement periodic minimum-change <0-10000>
no advertisement periodic
advertisement accelerated
advertisement accelerated threshold <1-100>
advertisement accelerated minimum-change <0-10000>
no advertisement accelerated
```

Parameters

one-way	The one-way value sets the mode to one-way measurement.
two-way	The two-way value sets the mode to two-way measurement.
<1000-15000>	Set the burst interval in milliseconds. The default value is 3000 milliseconds and the range is 1000-15000 milliseconds
<1-5>	Set the number of packets to be sent at each burst interval. The default value is 1 and the range is 1-5
<30-3600>	Set the computation interval in seconds. The default computation interval is 30 seconds. The range is 30-3600 seconds. This will be used also as the periodic advertisement interval.
<1-100>	Set the advertisement threshold percentage in the range of 1-100 (for periodic, default=10% and for accelerated, default=20%)
<1025-65535>	Set the TWAMP sender port value in the range 1025-65535. If not specified, the default value is 862)
<0-10000>	Set the advertisement minimum change in microseconds in the range 0-10000 (for periodic, default=1000 and for accelerated, default=2000)

Command Mode

Delay profile interface mode

Default

The default mode value is “two-way”.

Applicability

This command was introduced in OcNOS version 5.1.

Examples

```
#configure terminal
(config)#delay-profile interfaces
(config-dp-intf)#mode two-way
(config-dp-intf)#burst-count 5
(config-dp-intf)#burst-interval 3000
(config-dp-intf)#interval 30
(config-dp-int)#sender-port 862
(config-dp-intf)#advertisement periodic threshold 10
(config-dp-intf)#advertisement periodic minimum-change 1000
(config-dp-intf)#advertisement accelerated
(config-dp-intf)#advertisement accelerated threshold 20
(config-dp-intf)#advertisement accelerated minimum-change 2000
(config-dp-intf)#no advertisement periodic
(config-dp-intf)#commit
(config-dp-intf)#exit
(config)#
```

forwarding custom-profile

Use this command to configure forwarding table sizes.



Note: You must reboot after any profile change, except a change to the default profile. The configuration is applied only after a reboot.

Use `show-running configuration` or [show forwarding profile limit \(page 1711\)](#) to verify the selected profile.

Use the forwarding custom-profile default command (with no parameters) to set the forwarding table size to its default.

Command Syntax

Tomahawk platform:

```
forwarding custom-profile {l2-banks <1-4>|l3-banks <1-4>|lpm-banks 2}
```

Helix4 platform:

```
forwarding custom-profile {l2-banks <1-24>|l3-banks <1-23>|vlan-xlate-banks <1-23>|ep-vlan-xlate-banks <1-23>}
```

Tomahawk and Helix4 platforms:

```
forwarding custom-profile default
```

Parameters

l2-banks

L2 banks. Unspecified banks are used as L2 banks.

<1-4>

Number of L2 banks. Each bank size is 32k entries and each entry is 105 bits.

<1-24>

Number of L2 banks. Each bank size is 1k entries and each entry is 420 bits.

l3-banks

L3 banks. Unspecified banks are used as L2 banks.

<1-4>

Number of L3 banks. Each bank size is 32k entries and each entry is 105 bits.

<1-23>

Number of L3 banks. Each bank size is 1k entries and each entry is 420 bits.

lpm-banks

Longest-prefix match banks. Unspecified banks are used as L2 banks.

2

Two LPM banks per entry. The remaining banks can be used by any.

vlan-xlate-banks

VLAN translate banks. Unspecified banks are used as L2 banks.

<1-23>

Number of VLAN translate banks. Each bank size is 1k entries and each entry is 420 bits.

ep-vlan-xlate-banks

Egress VLAN translate banks. Unspecified banks are used as L2 banks.

<1-23>

Number of EP VLAN translate banks. Each bank size is 1k entries and each entry is 420 bits.

default

Use L2 profile Three; the size of the I2 table (MAC address table) and L3 table (host table) is almost equal.

Default

By default, the forwarding table size is L2 profile three: the sizes of the L2 table (MAC address table) and L3 table (host table) are almost equal.

Command Mode

Configure mode

Applicability

This command was introduced before OcNOS version 1.3

This command only applies to Tomahawk and Helix4 platforms.

Examples

```
#configure terminal
(config)#forwarding custom-profile l3-banks 4
```

forwarding profile

Use this command to configure different forwarding profiles in hardware.



Note: To apply profile configuration changes in the hardware, you must save the configuration and reboot, except when modifying the default profile.

Use [show forwarding profile limit \(page 1711\)](#) to verify the configured profile.

Use the no form of this command to set the forwarding profile to default.



Note: The use of **k** for “kilo” (as in 1k) does not equal 1,000. In all cases, **k** equals the Boolean value: 1,024.

Command Syntax

```
forwarding profile (l2-profile-one | l2-profile-two | l2-profile-three | l3-profile | l3-128bit-
profile | lpm-profile | lpm-128bit-profile)
no forwarding profile
```

Parameters

For details about these profiles, see [show forwarding profile limit \(page 1711\)](#).

I2-profile-one

L2 profile One

I2-profile-two

L2 profile Two

I2-profile-three

L2 profile Three (default); the sizes of the L2 table (MAC address table) and L3 table (host table) are almost equal

I3-profile

L3 profile

I3-128bit-profile

L3 profile with IPv6 prefix >64 support

lpm-profile

Longest-prefix match profile

lpm-128bit-profile

LPM profile with IPv6 prefix >64 support

Default

The default forwarding table size is I2-profile-three.

Command Mode

Configure mode

Applicability

This command was introduced before OcNOS version 1.3.

Examples

```
#configure terminal
(config)#forwarding profile l2-profile-one
```

ip redirects

Use this global command to trap **ICMP**¹ redirect packets to the CPU and on interface to enable ICMP redirects in kernel.

Use the `no` form of this command to disable the ICMP redirect message on an interface.



Note: This command is applicable for both IPv4 and IPv6 interfaces.

Command Syntax

```
ip redirects
no ip redirects
```

Parameters

None

Default

None

Command Mode

Interface mode

Applicability

Introduced in OcNOS version 3.0.

Example

```
#configure terminal
(config)#interface xe1/1
(config-if)#ip redirects

#configure terminal
(config)#interface xe1/1
(config-if)#no ip redirects
```

¹Internet Control Message Protocol (ICMP) is a fundamental protocol used in networking to relay error messages and operational information.

load-balance enable

Use this command to enable load-balancing configurations in hardware.

Use the no option to reset the load balancing to default settings.



Note: When the command `load-balance enable` is issued, the default load-balance settings are unset. User then has to configure the new load-balancing parameters.

Command Syntax

This form unsets load balancing globally:

```
load-balance enable
```

This form resets load balancing globally to default settings:

```
no load-balance enable
```

By default, load balancing is enabled for ECMP and **LAG**¹.

This form sets hashing based on IPv4 fields:

```
load-balance (ipv4 {src-ipv4 | dest-ipv4 | src14-port | dest14-port | protocol-id})
no load-balance (ipv4 {src-ipv4 | dest-ipv4 | src14-port | dest14-port | protocol-id})
```

This form sets hashing based on IPv6 fields:

```
load-balance (ipv6 {src-ipv6 | dest-ipv6 | src14-port | dest14-port | protocol-id | next-hdr})
no load-balance (ipv6 {src-ipv6 | dest-ipv6 | src14-port | dest14-port | protocol-id | next-hdr})
```

This form sets hashing based on L2 fields:

```
load-balance (l2 {dest-mac|src-mac|ether-type|vlan})
no load-balance (l2 {dest-mac|src-mac|ether-type|vlan})
```

Following additional parameters are supported on Dune DNX boards:

```
load-balance inner-ipv4 ({non-symmetric| protocol-id| src-dest-ipv4})
no load-balance inner-ipv4 ({non-symmetric| protocol-id| src-dest-ipv4})

load-balance inner-l2 ({ether-type| non-symmetric| src-dest-mac| vlan})
no load-balance inner-l2 ({ether-type| non-symmetric| src-dest-mac| vlan})

load-balance src-dest-l4port (non-symmetric)
no load-balance src-dest-l4port
```



Note: The configured load balancing parameters are global and will be applicable to all LAG & ECMP created in the hardware.

Parameter

ipv4

Load balance IPv4 packets

¹Link Aggregation Group

src-ipv4

Source IPv4 based load balancing

dest-ipv4

Destination IPv4 based load balancing

src-l4-port

Source L4 port based load balancing

dest-l4-port

Destination L4 port based load balancing

protocol-id

Protocol ID based load balancing

ipv6

Load balance IPv6 packets

src-ipv6

Source IPV6 based load balancing

dest-ipv6

Destination IPv6 based load balancing

src-l4-port

Source L4 port based load balancing

dest-l4-port

Destination L4 port based load balancing

l2

Load balance L2 packets

src-dest-mac

Source Destination based load balancing

non-symmetric

Non symmetrical based load balancing

ether-type

Ether-type based load balancing

Vlan

VLAN-based load balancing

labels

label stack based load balancing

inner-ipv4

Load balancing on IPv4 packet

inner-l2

Load balancing on L2 packet

src-dest-l4port

Source Destination l4port based load balancing

non-symmetric

Non symmetric based load balancing

protocol-id

Protocol Id based load balancing

src-dest-ipv4

Source Destination IPV4 based load balancing

ether-type

Ether-type based load balancing

src-dest-mac

Source Destination based load balancing

next-hdr

Next Header Field for IPV6

src-dest-ipv6

Source Destination IPV6 based load balancing

Command Mode

Configure mode

Applicability

This command was introduced before OcNOS version 3.0.

Examples

```
(config)#load-balance enable
(config)#load-balance ipv4 src-ipv4
```

hardware-profile filter (XGS)

Use this command to enable or disable ingress IPv4 or IPv6 and egress IPv6 filter groups. Disabling filter groups increases the configurable filter entries.

Use the no command to remove explicit enable/disable config for the filter group and switch to default behavior for that filter group.

Command Syntax

```
hardware-profile filter port-isolation (ingress-mirror|ingress-ipv4|ingress-ipv6|egress-ipv6|ingress-arp|bfd-group) (enable|disable)
no hardware-profile filter (ingress-ipv4|ingress-ipv6|egress-ipv6|bfd-group)
```



Notes:

- 'no' command is provided only for ingress-ipv4, ingress-ipv6 and egress-ipv6. By default, group is enabled. To increase scalability for other groups, disable the group.
- During multiple add/delete entry operation execution in TCAM, entry movement is possible which may lead to delay in completion of operation in hardware resulting into higher cpu utilization.
- **bfd-group** filter is applicable only for Trident-3 devices. Only after enabling the bfd-group filter bfd sessions will be up in Trident-3.
- Trident4 devices share hardware resources between some ingress and egress profiles. For instance, ingress-ipv4 and **ingress-ipv6** will share physical resources, and **egress-ipv6** will share resources with the **egress 12/ipv4/QoS** profile enabled by default. Consequently, resource usage is counted equally for all shared profiles whenever one of the profiles uses more entries. Shared profiles are marked with the (*) in the output of the `show hardware-profile filters` command.
- Configuring and unconfiguring access-list to the interface in a single commit is not recommended.

Example:

```
OcNOS (config) #interface xe8
OcNOS (config-if) #no ip access-group ACL1v4 out
OcNOS (config-if) #exit
OcNOS (config) #interface xe3
OcNOS (config-if) #ip access-group ACL2v4 out
OcNOS (config-if) #commit
```

Parameter

ingress-mirror

Ingress TCAM group for Port-mirroring

ingress-ipv4

IPv4 filter ingress group.

ingress-ipv6

IPv6 filter ingress group.

egress-ipv6

IPv6 filter egress group.

enable

Enable filter group.

disable

Disable filter group.

ingress-arp

ARP filter ingress group

bfd-group

BFD filter group

port-isolation

The filter must be enabled before configuring port isolation. Since default filter groups are full, some unused filter needs be disabled in order to enable port-isolation filter.

no

Reset the group to as it was during init

Default

By default, all filter groups are enabled except the ingress-arp,bfd-group, port-isolation filter group.

Command Mode

Configure mode

Applicability

This command was introduced before OcNOS version 1.3.

The **no** command is introduced in OcNOS version 4.2.

The ingress-mirror option was introduced in OcNOS version 6.4.1 release.

Examples

```
#configure terminal
(config)#hardware-profile filter ingress-ipv4 disable
(config)#hardware-profile filter ingress-ipv4 enable
(config)#no hardware-profile filter ingress-ipv4
(config)#hardware-profile filter ingress-ipv6 disable
(config)#hardware-profile filter port-isolation enable
(config)# hardware-profile filter ingress-mirror enable
```

load-balance rtag7

Use this command to configure rtag7 load balancing.

Use the `no` option to disable the rtag7 load balancing.



Note: Configuring the `load-balance rtag7` removes the default load-balance settings. Hence, reconfigure the load-balance parameters again.

Command Syntax

This form enables or disables rtag7 load balancing globally:

```
load-balance rtag7
no load-balance rtag7
```

By default, load balancing is enabled for ECMP, and **LAG**¹.

This form sets rtag7 hashing for ECMP and L3 LAG based on IPv4 fields:

```
load-balance rtag7 (ipv4 {src-ipv4|dest-ipv4|src14-port|dest14-port|protocol-id})
no load-balance rtag7 (ipv4 {src-ipv4|dest-ipv4|src14-port|dest14-port|protocol-id})
```

By default, IPv4 ECMP is configured with the fields **src-ipv4**, **dest-ipv4**, **src14-port**, and **dest-14port**.

By default, L3 LAG is configured with the fields **src-ipv4** and **dest-ipv4**.

This form sets rtag7 hashing for ECMP based on IPv6 fields:

```
load-balance rtag7 (ipv6 {src-ipv6|dest-ipv6|src14-port|dest14-port|next-hdr})
no load-balance rtag7 (ipv6 {src-ipv6|dest-ipv6|src14-port|dest14-port|next-hdr})
```

By default, IPv6 ECMP is configured with the fields **src-ipv6**, **dest-ipv6**, **src14-port**, and **dest-14port**.

This form sets rtag7 hashing for L2 LAG based on L2 fields:

```
load-balance rtag7 (l2 {dest-mac|src-mac|ether-type|vlan})
no load-balance rtag7 (l2 {dest-mac|src-mac|ether-type|vlan})
```

Please note the following:

- For ingress LER nodes, hashing is done on L2 fields, L3 fields (outer IPx), or inner IP fields (only for IPx-over-IPx or IPx-over-GRE-IPx).

This form sets rtag7 hashing based on the outer IP address:

```
load-balance rtag7 (tunnel outer-l3-header)
no load-balance rtag7 (tunnel outer-l3-header)
```

Parameters

ipv4

Load balance IPv4 packets

src-ipv4

Source IPv4 based load balancing

¹Link Aggregation Group

dest-ipv4

Destination IPv4 based load balancing

src-l4-port

Source L4 port based load balancing

dest-l4-port

Destination L4 port based load balancing

protocol-id

Protocol ID based load balancing

ipv6

Load balance IPv6 packets

src-ipv6

Source IPv6 based load balancing

dest-ipv6

Destination IPv6 based load balancing

src-l4-port

Source L4 port based load balancing

dest-l4-port

Destination L4 port based load balancing

next-hdr

Next header field for IPv6

l2

Load balance L2 packets

dest-mac

Destination MAC address based load balancing

src-mac

Source MAC address based load balancing

ether-type

Ether-type based load balancing

vlan

VLAN-based load balancing

tunnel

Load balance tunneled packets based on outer header (default uses the inner-header)

outer-l3-header

Use outer header for hashing (ip-over-ip, ipv6-over-ip, ip-over-gre-ip, ipv6-over-gre-ip, ipv6-over-ipv6, ip-over-ipv6, ip-over-gre-ipv6, ipv6-over-gre-ipv6)

inner-l2

Load balance Inner L2 header

dest-mac

Destination MAC address load balancing

src-mac

Source MAC address

ether-type

Ether-type based load balancing

vlan

VLAN tag id

inner-l3

Inner l3 header

dest-ip

Destination IP address

src-ip

Source IP address

src-l4-port

Source L4 port based load balancing

protocol ID

Protocol (IPv4), next-hdr (IPv6)

Command Mode

Configure mode

Applicability

This command was introduced before OcNOS version 1.3.

Examples

```
(config)#load-balance rtag7
(config)#load-balance rtag7 ipv4 src-ipv4
```

load-balance rtag7 all-lag-if

Use this command to configure the load balance rtag7 globally for all logical po/sa interface types.

Use the *no* parameter to un-configure the load balance globally.**Command Syntax**

```
load-balance rtag7 all-lag-if
no load-balance rtag7 all-lag-if
```

Parameter

None

Command Mode

Configure mode

Applicability

This command was introduced in OcNOS version 6.6.0.

Examples

```
#configure terminal
(config)# load-balance rtag7 all-lag-if
(config)#no load-balance rtag7 all-lag-if
```

load-balance rtag7 hash

Use this command to set the rtag7 hash computation method.

Use the `no` parameter to set the rtag7 hash computation method to its default.

Command Syntax

```
load-balance rtag7 hash (crc16-bisync|crc16-ccitt|crc32-lo|crc32-hi)
no load-balance rtag7 hash
```

Parameters

crc16-bisync

16-bit CRC16 using the binary synchronous polynomial.

crc16-ccitt

16-bit CRC16 using the CCITT polynomial.

crc16-hi

16 most significant bits of computed CRC32.

crc16-lo

16 least significant bits of computed CRC32

Default

The default rtag7 hash computation method is 16-bit CRC16 using the binary synchronous polynomial (**crc16-bisync**).

Default Setting: `load-balance rtag7 hash crc16-bisync`

Command Mode

Configure mode

Applicability

This command was introduced before OcNOS version 1.3.

Example

```
#configure terminal
Enter configuration commands, one per line. End with CNTL/Z.
(config)#load-balance rtag7
(config)#load-balance rtag7 hash crc16-ccitt
(config)#show running-config | inc rtag7
!
load-balance rtag7
load-balance rtag7 hash crc16-ccitt
!
(config)#no load-balance rtag7 hash
(config)#
```

load-balance rtag7 macro-flow

Use this command to enable rtag7 macro-flow based hashing.

When macro-flow is enabled, a hash function is chosen dynamically based on corresponding macro flow. It is useful when hash polarization is observed in the topology.



Note: In case of topology having multiple level of split paths, macro-flow improves the distribution but can still have variation in traffic distribution. It is observed that when 2 level of hashing is present in topology (**LAG**¹ after ECMP split traffic to half), 6% of variation was observed.

Use the **no** parameter to disable rtag7 macro-flow based hashing.

Command Syntax

```
load-balance rtag7 macro-flow
no load-balance rtag7 macro-flow
```

Parameters

None

Default

By default, rtag7 macro-flow based hashing is disabled.

Command Mode

Configure mode

Applicability

This command was introduced before OcNOS version 1.3

Example

```
#configure terminal
Enter configuration commands, one per line. End with CNTL/Z.
(config)#load-balance rtag7
(config)#load-balance rtag7 macro-flow
(config)#show running-config | inc rtag7
!
load-balance rtag7
load-balance rtag7 macro-flow
!
(config)#no load-balance rtag7 macro-flow
```

¹Link Aggregation Group

show forwarding profile limit

Use this command to show all the forwarding table sizes.



Note: The use of **k** for “kilo” (as in 1k) does not equal 1,000. In all cases, **k** equals the Boolean value: 1,024.

Command Syntax

```
show forwarding profile limit
```

Parameters

None

Default

None

Command Mode

Execution mode

Applicability

This command was introduced before OcNOS version 1.3.

Examples

```
#show forwarding profile limit
Configured profile : custom-profile
Forwarding profile : custom-profile(Active in hardware)
-----
|                               Forwarding Profile Table Size                               |
|-----|-----|-----|-----|-----|-----|-----|
| Profile Name |MAC   |Host-Table |Prefix-  |Vlan-    |Egress-  |
|              |ADDR  |Table(UC)  |Table(UC)|xlate-   |Vlan-xlate|
|              |Table |IPv4   |IPv6   |IPv4   |IPv6   |Table  |Table  |
|-----|-----|-----|-----|-----|-----|-----|
| 12-profile-one | 96k  | 0k     | 0k    | 8k    | 4k    | 0k    | 0k    |
| 12-profile-two  | 64k  | 8k     | 4k    | 8k    | 4k    | 8k    | 8k    |
| 12-profile-three| 32k  | 16k    | 8k    | 8k    | 4k    | 16k   | 16k   |
|   13-profile   | 4k   | 92k    | 46k   | 8k    | 4k    | 0k    | 0k    |
| custom-profile  | 576k | 60k    | 30k   | 8k    | 4k    | 0k    | 0k#   |
```

[Table 111](#) explains the show command output fields.

Table 111. show forwarding profile limit output

Field	Description
Profile Name	Names of the forwarding profiles

Table 111. show forwarding profile limit output (continued)

Field	Description
MAC ADDR Table	MAC address table sizes
Host-Table (UC) IPv4	IPv4 unicast host table sizes
Host-Table (UC) IPv6	IPv6 unicast host table sizes
Prefix-Table (UC) IPv4	IPv4 unicast prefix table sizes
Prefix-Table (UC) IPv6	IPv6 unicast prefix table sizes
Vlan-xlate-Table	Number of VLAN translate banks
Egress-Vlan-xlate-Table	Number of egress VLAN translate banks

show hardware-profile filters

Use this command to check the status of hardware filter groups. Status is not shown for filter groups which are disabled.

Command Syntax

```
show hardware-profile filters
```

Parameters

None

Default

None

Command Mode

Execution mode Privileged execution mode

Applicability

This command was introduced before OcNOS version 1.3.

Examples

```
#show hardware-profile filters
INGRESS:
+-----+-----+-----+-----+-----+-----+
|          | Free  |      Used      |      Total Entries      | | | |
| TCAMS    | Entries |-----|-----|
|          |        | % | Entries | Total | Dedicated | shared |
+-----+-----+-----+-----+-----+-----+
QOS        244    5    12    256    256    0
L2-ACL     253    1    3    256    256    0
IPV4-ACL   256    0    0    256    256    0
ARP-ACL    242    5    14   256    256    0
EGRESS:
+-----+-----+-----+-----+-----+-----+
|          | Free  |      Used      |      Total Entries      | | | |
| TCAMS    | Entries |-----|-----|
|          |        | % | Entries | Total | Dedicated | shared |
+-----+-----+-----+-----+-----+
L2-ACL/IPV4-ACL/QOS 512    0    0    512    256    256
```

[Table 112](#) explains the output fields.

Table 112. show hardware-profile filters

Field	Description
EGRESS	Egress filtering is a process in which outbound data is monitored or restricted, usually by means of a firewall that blocks packets that fail to meet certain security requirements.

Table 112. show hardware-profile filters (continued)

Field	Description
INGRESS	Ingress filtering is a method used to prevent suspicious traffic from entering a network.
TCAMS	Number of ternary content addressable memory (TCAM) entries a particular firewall filter.
Free Entries	Number of TCAM filter entries available for use by the filter group.
Used Entries	Number of TCAM filter entries used by the filter group.
Total Entries	Number of TCAM total filter entries to the filter group.
Dedicated Entries	Number of TCAM filter entries dedicated to the filter group.
Shared Entries	Number of TCAM filter entries shared to the filter group.

Linux Shell Commands

This chapter is a reference for Linux shell commands that you can run at the OcNOS prompt.

The below table describes the commands:



Notes:

- You must be in privileged exec mode to run these commands.
- You cannot use the pipe ("|") or redirect (">") operators.

Table 113. Linux shell commands

Command	Description
<code>cat file</code>	Display contents of <i>file</i>
<code>cd</code>	Change to home directory
<code>cd dir</code>	Change directory to <i>dir</i>
<code>cp file1 file2</code>	Copy <i>file1</i> to <i>file2</i>
<code>cp -r dir1 dir2</code>	Copy <i>dir1</i> to <i>dir2</i> ; create <i>dir2</i> if it does not exist
<code>dir</code>	Display contents of current directory
<code>less file</code>	Display the contents of file
<code>ls options</code>	Display contents of current directory
<code>mkdir dir</code>	Create a directory <i>dir</i>
<code>more file</code>	Display the contents of <i>file</i>
<code>mv file1 file2</code>	Rename <i>file1</i> to <i>file2</i>
<code>mv file dir</code>	Move <i>file</i> to directory <i>dir</i>
<code>pwd</code>	Display current directory
<code>rmdir dir</code>	Remove a directory <i>dir</i> (only if empty)

Commit Rollback

Overview

The Commit Rollback capability in Common Management Layer Commands (CMLSH) is designed to execute a rollback operation for a set of configurations that were previously committed, with each commit operation identified by a unique commit ID. The Commit ID is numeric value and is generated by the CMLSH Commit, Confirmed Commit and Commit Rollback.

This Commit Rollback application is used for rolling back the commits that are performed after the specified commit ID whether they were executed through either Commit or Confirmed Commit operations.

Here, you find the description for Commit and Confirmed Commit:

- Commit operation: Involves committing the candidate configuration to the running configuration.
- Confirmed Commit operation: Provides more options to the commit operation with timeout parameter, user could provide timeout for the commit (default is 300 seconds).

During this timeout interval, users can either confirm the commit or cancel it, and if no confirmation or cancellation is provided before the timer expires, commit will be automatically rolled back after timeout.

Commit Rollback Characteristics

The Confirmed-Commit operation temporarily applies the configuration for the duration specified in seconds. If the user does not confirm the configuration within this timeframe, an automatic rollback will be initiated once the timer expires. For committing the configurations with timings, see [commit \(page 1482\)](#)

Once the configurations are confirmed, users can use the commit rollback operation to revert the configuration, whether it is for a commit operation or a confirmed commit operation.

Benefits

With the integration of CMLSH Commit Rollback with Standard or Confirmed Commit, users can initiate a rollback operation for any specific commit, utilizing the associated commit ID to revert the configurations to their previous state. In this way, reverting to an earlier state, functional configuration is possible in case the new configuration is compromised or if the configuration makes the device unstable.

Prerequisites

Before configuring this operation, enable `cml commit-history` to ensure the commit records are stored in the commit history list. By default, `cml commit-history` is enabled. For enabling or disabling it, see [cml commit-history \(page 1720\)](#).

show commit list

Use this command to display a record of commit operations stored in the commit history list.



Note: For commit records to be stored in the commit history list, enable [cml commit-history \(page 1720\)](#). Otherwise, commit operations will not be stored.

Command Syntax

```
show commit list
```

Parameters

None

Command Mode

Execution mode

Applicability

This command is introduced in OcNOS version 6.4.1.

Example

Example for show commit list:

```
#show commit list
S.No.      ID                User   Client      TimeStamp      Commit
Status     Description
~~~~~
1          1684542224876712  ocnos  cmlsh       20-05-2023
00:23:44   Confirmed          NA
```

commit-rollback

Use this command to revert configurations to a previously committed stable state. This action will remove configurations made after the provided commit ID (Word).



Note: To use commit-rollback, cml commit-history must be enabled.

Command Syntax

```
commit-rollback to WORD (description LINE|)
```

Parameter

Word

Commit ID associated with recorded commit operations stored within the commit- history list.

description LINE

[Optional] Short description about commit-rollback, maximum 65 characters.

Command Mode

Execution mode

Applicability

This command is introduced in OcNOS 6.4.1.

Example

Example output for commit-rollback WORD:

```
#show commit list
S.No.      ID              User  Client      TimeStamp      Commit
Status     Description
~~~~~
1         1684542445002144  ocnos  cmlsh      20-05-2023
00:27:25      Confirmed              NA
```

Example of a Commit Rollback to the Commit List ID 1684542445002144:

```
#commit-rollback to 1684542445002144 description commit-rollback Test
#show commit list
S.No.      ID              User  Client      TimeStamp      Commit
Status     Description
~~~~~
1         1684542445002144  ocnos  cmlsh      20-05-2023
00:27:25      Confirmed              NA
2         1684542402123428  ocnos  cmlsh      20-05-2023 00:28:45  Rollback to 20-05-2023
00:27:25      commit-rollback Test
```

Example of an automatic Commit Rollback

```
#show commit list
S.No.      ID              User  Client      TimeStamp      Commit
Status     Description
~~~~~
~~~~~
#show run router ospf
!
#configure terminal
Enter configuration commands, one per line.  End with CNTL/Z.
(config)#router ospf 5
(config-router)#router ospf 6
(config-router)#commit confirmed timeout 20 description This is to test auto rollback of config
(config-router)#end
#show commit list
S.No.      ID              User  Client      TimeStamp      Commit
Status     Description
~~~~~
~~~~~
1         1698242643599569  root   cmlsh      25-10-2023 14:04:03  Remaining Time:
17         This is to test auto rollback of config
#show run router ospf
!
router ospf 5
!
router ospf 6
!
#
```

```
Warning!!! Confirmed-commit timed out for commitid: 1698242643599569
#show commit list
S.No.      ID          User   Client      TimeStamp      Commit
Status     ~~~~~
~~~~~
1         1698242643599569   root   cmlsh      25-10-2023 14:04:03   Timed-out
(Reverted) This is to test auto rollback of config
#show run router ospf
!
#
```

clear cml commit-history (WORD|)

Use this command to delete any specific entry mentioned by commit ID or to delete entire list entries.



Notes:

- To use the commit-rollback operation, the **cml commit-history** operation must be enabled, and note that commit-rollback cannot be used for deleted entries.
- While the commit confirmation is in progress, the commit entries cannot be deleted using this command.

Command Syntax

```
clear cml commit-history (WORD|)
```

Parameters

Word

commit ID of the recorded commit operations into commit-history list

Default

When no parameter is provided, the commit history is deleted by default. If you specify the 'Word' parameter, it will delete the specific commit record.

Command Mode

Execution mode

Applicability

This command is introduced in OcNOS version 6.4.1.

Example

Example for clear commit using Commit History ID:

```
#show commit list

S.No.      ID          User   Client      TimeStamp      Commit
Status     ~~~~~
~~~~~
```

```

~~~~~
 1  1684486018411866  ocnos  cmlsh  19-05-2023
08:46:58                Confirmed      NA
 2  1684486037040268  ocnos  cmlsh  19-05-2023 08:47:17          Confirmed

#clear cml commit-history 1684486018411866
#show commit list

S.No.      ID          User  Client      TimeStamp      Commit
Status
~~~~~
 1  1684486037040268  ocnos  cmlsh  19-05-2023
08:47:17                Confirmed      NA

```

cml commit-history

Use this command to enable or disable confirmed commit operation (commit-history operation). To verify the state of the operation, use the command **show cml commit-history state**.



Notes:

- By default, cml commit-history operation is enabled.
- After disabling the cml commit-history operation, confirmed commit CLIs cannot be used, rendering the [confirm-commit \(WORD|\) \(page 1484\)](#), and [cancel-commit \(WORD|\) \(page 1459\)](#) operations unavailable.

Command Syntax

```
cml commit-history (enable | disable)
```

Parameters

enable

Enables commit confirmed and commit rollback operations

disable

Disables commit confirmed and commit rollback operations

Default

By default, commit confirmed and commit rollback operations are enabled.

Command Mode

Configure mode

Applicability

This command is introduced in OcNOS version 6.4.1 and updated the Command Mode to Configuration mode in OcNOS version 6.6.0 .

Examples

Example for disabling Commit History:

```
OcNOS#configure terminal
Enter configuration commands, one per line.  End with CNTL/Z.
OcNOS(config)#cml commit-history disable
OcNOS(config)#commit
```

Example for verifying Commit History when commit-history is disabled:

```
OcNOS#show run commit-history
!
cml commit-history disable
!
OcNOS#
OcNOS#show xml run netconf-server
<netconf-server xmlns="http://www.ipinfusion.com/yang/ocnos/ipi-management-serve
r">
.
.
<commit-history>
  <config>
    <disable-commit-history></disable-commit-history>
  </config>
</commit-history>
OcNOS#
OcNOS#show cml commit-history state
cml commit-history feature is disabled
```

Example for enabling Commit History:

```
OcNOS#configure terminal
Enter configuration commands, one per line.  End with CNTL/Z.
OcNOS(config)#cml commit-history enable
OcNOS(config)#commit
```

Example for verifying Commit History when the commit-history is enabled, either by default or explicitly, it will not be displayed in the show run or show xml commands.

```
OcNOS#show run commit-history
!
OcNOS#
OcNOS#
OcNOS#show xml run netconf-server
=== NO config for commit-history =====
OcNOS#
OcNOS#show cml commit-history state
cml commit-history feature is enabled
OcNOS#
```

cml commit-id rollover

Use this command to enable or disable commit entry rollover when the maximum count of 50 commit entries is reached. When enabled, older commit entries will be automatically deleted from the commit history list to record new entries. When disabled and list contains 50 entries, commit confirmed operation is not allowed.

To verify the state of the operation, use command `show cml commit-id rollover state`.



Notes:

- By default, cml commit-id rollover operation is enabled.
- The cml commit-history operation must be enabled to use this operation.
- The commit-rollback operation can not be used for deleted entry.
- When this operation is disabled and the number of commit entries reaches the maximum count, the addition of commit records to the commit history list will be stopped.
- If this operation is disabled and the list contains 50 entries, the commit-confirmed operation cannot be performed. However, a normal commit operation is allowed even with 50 entries in the list.

Command Syntax

```
cml commit-id rollover (enable | disable)
```

Parameters

enable

Enables commit ID rollover

disable

Disables commit ID rollover

Default

By default, commit ID rollover is enabled.

Command Mode

Execution mode

Applicability

This command is introduced in OcNOS version 6.4.1.

Example

Example for verifying commit ID rollover state:

```
#show cml commit-id rollover state  
cml commit-id rollover feature is enabled
```

INDEX

A

aaa accounting details, 196
 aaa authentication attempts login, 195
 aaa authentication login, 195
 aaa authentication login console, 197
 aaa authentication login default, 197
 aaa authentication login default fallback error, 200-201
 aaa authorization config-commands default, 202
 aaa group server, 202
 aaa local authentication attempts max-fail, 203
 abort transaction, 1458
 Access Lists, 501
 arp A.B.C.D MAC, 1389
 Authentication, 501
 authentication, 1348

B

banner, 1374
 begin modifier, 135
 BGP community value
 command syntax, 133
 braces
 command syntax, 133

C

Chassis Management Module Commands, 818
 clear crypto sa map, 1348
 clear ip prefix-list, 1557
 clear ipv6 neighbors, 1558
 clear ntp statistics, 533
 clear ssh hosts, 281
 clear tfo counter, 895
 Client, 501
 clock timezone, 1377
 cml force-unlock config-datastore, 1469
 cml lock config-datastore, 1470
 cml logging, 1472-1473
 cml netconf translation, 1474
 cml unlock config-datastore, 1475
 cmlsh multiple-config-session, 1477
 cmlsh transaction, 1480
 cmlsh transaction limit, 1481
 command abbreviations, 131
 command completion, 131
 command line
 errors, 131
 help, 130
 keyboard operations, 134
 command modes, 137
 configure, 137
 exec, 137
 interface, 138

 privileged exec, 137
 router, 138
 command negation, 132
 command syntax
 (), 132
 ., 133
 ?, 133
 [], 133
 {}, 133
 |, 132
 A.B.C.D/M, 133
 AA:NN, 133
 BGP community value, 133
 braces, 133
 conventions, 132
 curly brackets, 133
 HH:MM:SS, 133
 IFNAME, 133
 interface name, 133
 IPv4 address, 133
 IPv6 address, 133
 LINE, 133
 lowercase, 132
 MAC address, 133
 monospaced font, 132
 numeric range, 133
 parentheses, 132
 parenteses, 132
 period, 133
 question mark, 133
 square brackets, 133
 time, 133
 uppercase, 132
 variable placeholders, 133
 vertical bars, 132
 WORD, 133
 X:X::X:X, 133
 X:X::X:X/M, 133
 XX:XX:XX:XX:XX:XX, 133
 commit, 1482
 common commands
 banner, 1374
 clear ip prefix-list, 1557
 configure terminal, 1378
 copy running-config startup-config, 1383
 disable, 1386, 1415
 enable, 1388
 enable password, 1389
 end, 1390
 exit, 1392
 ip prefix-list, 1583
 ip remote-address, 1586
 ip unnumbered, 1587
 ipv6 prefix-list, 1591
 ipv6 unnumbered, 1593

- reload, 1410-1411
- service advanced-vty, 1411
- service password-encryption, 1412
- service terminal-length, 1413
- show access-list, 1415
- show cli, 1415
- show ip prefix-list, 1658
- show startup-config, 1431
- show version, 1439
- write terminal, 1452
- Common NSM Layer 2 commands
 - flowcontrol off, 1575
 - show flowcontrol interface, 1606
- configuration, 886
- configure mode, 137
- configure terminal, 1378
- configuring sFlow, 700
- Control Port Group, 886, 896-897
- copy ftp running-config (interactive), 1537
- copy ftp startup-config, 1532-1533
- copy ftp startup-config (interactive), 1538
- copy http startup-config, 1537
- copy http startup-config (interactive), 1542
- copy running-config, 1524
- copy running-config (interactive), 1525
- copy running-config start-config, 1383
- copy scp (startup-config|running-config), 1534
- copy scp startup-config, 1534
- copy scp startup-config (interactive), 1539
- copy sftp (startup-config|running-config), 1535
- copy sftp startup-config, 1535
- copy sftp startup-config (interactive), 1540
- copy startup-config, 1526
- copy startup-config (interactive), 1527
- copy system file, 1528
- copy system file (interactive), 1530
- copy tftp startup-config, 1536
- copy tftp startup-config (interactive), 1541
- crypto ipsec transform-set, 1348
- crypto isakmp policy, 1351
- crypto map (Configure Mode), 1351
- curly brackets
 - command syntax, 133

D

- ddm monitor, 856
- debug cml, 1491
- debug cmm, 821
- debug ddm, 859, 863
- debug dns client, 492
- debug ntp, 535
- debug radius, 233
- debug sflow, 744
- debug snmp-server, 609
- debug ssh server, 283
- debug tacacs+, 217
- debug telnet server, 270
- debug user-mgmt, 347
- disable, 1386, 1415

- do, 1387
- domain-name, ip, 494

E

- enable, 1388
- enable password, 1389
- end, 1390
- exec command mode, 137
- exit, 1392

F

- Fail Over Group, 886
- feature dhcp, 411
- feature ntp, 535
- feature sflow, 745
- feature ssh, 284
- feature tacacs+, 221
- feature telnet, 271
- fec, 1573
- flowcontrol off, 1575
- fog tfc, 896
- fog type, 897

H

- hardware-profile portmode, 1577, 1704

I

- if-arbiter, 1578
- IFNAME, 133
- interface, 1567, 1569, 1579
- interface mode, 138
- ip address, 1580
- ip address dhcp, 412, 1581
- ip dhcp client request, 413
- ip dhcp relay, 426, 428
- ip dhcp relay address, 429
- ip dhcp relay information option, 431
- ip domain-list, 493
- ip domain-lookup, 494
- ip domain-name, 494
- ip forwarding, 1582
- ip host, 495
- ip name-server, 496
- ip prefix-list, 1583
- ip proxy-arp, 1585
- ip remote-address, 1586
- ip unnumbered, 1587
- ip vrf, 1588
- ip vrf forwarding, 1588
- IPv4 address
 - command syntax, 133
- IPv6 address
 - command syntax, 133
- ipv6 dhcp relay, 436, 438
- ipv6 dhcp relay address, 439
- ipv6 dhcp relay subscriber-id, 444
- ipv6 forwarding, 1590

ipv6 prefix-list, 1591
 ipv6 unnumbered, 1593

L

LINE, 133
 link-type, 898
 load-balance, 1706
 load-balance rtag7, 1706
 locator led, 822
 Logging Console Configuration, 649
 logging level, 670
 logging logfile, 673
 logging source-interface, 681
 logging timestamp, 681
 logout, 1400

M

MAC address
 command syntax, 133
 Maxpoll and Minpoll Configuration, 503
 Monitor Port Group, 886, 896-897
 Monitor Port Groups, 896
 multicast, 1605
 Multicast Commands
 multicast, 1605
 show ip rpf, 1635

N

NSM Commands
 arp A.B.C.D MAC, 1389
 clear ipv6 neighbors, 1558
 if-arbiter, 1578
 interface, 1567, 1569, 1579
 ip address, 1580
 ip address dhcp, 1581
 ip forwarding, 1582
 ip proxy-arp, 1585
 ipv6 forwarding, 1590
 multicast, 1605
 show debugging nsm, 1423
 show ip forwarding, 1637
 show ip interface brief, 1638
 show ipv6 forwarding, 1653
 show ipv6 interface brief, 1654
 show ipv6 route, 1656
 show nsm client, 1426
 ntp access-group, 537
 ntp authenticate, 537
 NTP Authentication, 504
 ntp authentication-key, 538
 NTP Configuration, 502
 ntp enable, 538
 ntp logging, 540
 ntp master, 542
 ntp peer, 542
 ntp server, 544
 ntp trusted-key, 546

P

parentheses
 command syntax, 132
 parentheses
 command syntax, 132
 Peer, 501
 period
 command syntax, 133
 ping, 1402
 port breakout configuration, 950, 1199, 1215
 prefix-list, 1583
 privileged exec mode, 137

Q

question mark
 command syntax, 133

R

RADIUS Server Accounting, 160
 RADIUS Server Authentication, 153
 radius-server deadtime, 234
 radius-server directed-request, 234
 radius-server host, 234
 radius-server host acct-port, 235
 radius-server host auth-port, 236
 radius-server host key, 239
 radius-server key, 239
 radius-server retransmit, 240
 radius-server timeout, 240
 reload, 1410-1411
 reset log file, 692
 router mode, 138

S

server, 207
 Server, 501
 service advanced-vty, 1411
 service password-encryption, 1412
 service terminal-length, 1413
 set security-association lifetime, 1354
 set session-key, 1354
 set transform-set, 1356
 sFlow, 745
 sflow collector, 747
 show aaa accounting, 208
 show aaa authentication, 208
 show aaa authentication login, 209
 show access-list, 1415
 show access-lists, 1315
 show cli, 1415
 show cmlsh multiple-config-session status, 1506
 show commands, 135
 exclude modifier, 136
 include modifier, 136
 redirect modifier, 137
 show crypto ipsec transform-set, 1358

- show debug radius, 241
 - show debug ssh server, 285
 - show debug tacacs+, 222
 - show debug telnet server, 272
 - show debugging nsm, 1423
 - show flowcontrol interface, 1606
 - show hardware-information, 823
 - show hosts, 497
 - show ip dhcp relay, 447
 - show ip dhcp relay address interface, 448
 - show ip forwarding, 1637
 - show ip interface brief, 1638
 - show ip prefix-list, 1658
 - show ip vrf, 1652
 - show ipv6 dhcp relay, 452
 - show ipv6 dhcp relay address, 453
 - show ipv6 forwarding, 1653
 - show ipv6 interface brief, 1654
 - show ipv6 route, 1656
 - show logging, 682
 - show logging last, 684
 - show logging logfile, 685
 - show logging logfile last-index, 686
 - show logging logfile start-seqn end-seqn, 687
 - show logging logfile start-time end-time, 688
 - show max-transaction limit, 1512
 - show nsm client, 1426
 - show ntp authentication-keys, 547
 - show ntp authentication-status, 548
 - show ntp client, 548
 - show ntp logging-status, 548
 - show ntp peers, 550
 - show ntp peer-status, 549
 - show ntp statistics, 551
 - show ntp status, 553
 - show ntp trusted-keys, 553
 - show priority-flow-control details, 863
 - show process, 1427
 - show radius-server, 242
 - show running-config, 1428
 - show running-config aaa, 213
 - show running-config dhcp, 454
 - show running-config dns, 498
 - show running-config interface, 1662
 - show running-config interface ip, 1664
 - show running-config interface ipv6, 1665
 - show running-config ipv6 access-list, 1667
 - show running-config ntp, 553
 - show running-config prefix-list, 1668
 - show running-config radius, 243
 - show running-config snmp, 610
 - show running-config ssh server, 286
 - show running-config switch, 1429
 - show running-config syslog, 690
 - show running-config tacacs+, 225
 - show running-config telnet server, 273
 - show sflow, 754, 757
 - show sflow interface, 756
 - show snmp, 611, 620, 640
 - show snmp community, 612
 - show snmp engine-id, 614
 - show snmp group, 615
 - show snmp host, 616
 - show snmp user, 617
 - show snmp view, 618
 - show ssh server, 289
 - show startup-config, 1431
 - show system restore failures, 1516
 - show system-information, 839
 - show tacacs-server, 226
 - show telnet server, 274
 - show tfo, 899
 - show transaction current, 1517
 - show transaction last-aborted, 1518
 - show transceivers details, 879
 - show username, 290
 - show users, 1437
 - show version, 1439
 - show vlog all, 692
 - show vlog terminals, 695
 - show vlog virtual-routers, 696
 - Simple Network Management Protocol, 595
 - snmp-server community, 623
 - snmp-server contact, 626
 - snmp-server enable snmp, 629
 - snmp-server enable traps, 630
 - snmp-server group, 635
 - snmp-server host, 635
 - snmp-server location, 637
 - snmp-server tcp-session, 639
 - snmp-server view, 643
 - Software Monitoring and Reporting-406371cb-b162-43e8-b29e-15e4927833e8, 716
 - square brackets
 - command syntax, 133
 - SSH Client session, 252
 - ssh key, 297
 - ssh login-attempts, 299
 - ssh server port, 308
- ## T
- tacacs-server deadtime, 228
 - tacacs-server directed-request, 228
 - tacacs-server host, 228
 - tacacs-server key, 230
 - Telnet, 269
 - telnet server port, 277
 - time
 - command syntax, 133
 - traceroute, 1449
 - trigger failover, 900
 - Trigger Failover Commands, 895
- ## U
- username, 350
 - username keypair, 311
 - username sshkey, 310

V

vertical bars

command syntax, 132

VLOG commands, 691

reset log file, 692

show vlog all, 692

show vlog terminals, 695

show vlog virtual-routers, 696

VPN Commands

ip vrf, 1588

ip vrf forwarding, 1588

show ip vrf, 1652

W

WORD, 133

write terminal, 1452