



OcNOS®

**Open Compute
Network Operating System for Data Centers
Version 6.4.2**

Quality of Service Guide

December 2023

© 2023 IP Infusion Inc. All Rights Reserved.

This documentation is subject to change without notice. The software described in this document and this documentation are furnished under a license agreement or nondisclosure agreement. The software and documentation may be used or copied only in accordance with the terms of the applicable agreement. No part of this publication may be reproduced, stored in a retrieval system, or transmitted in any form or any means electronic or mechanical, including photocopying and recording for any purpose other than the purchaser's internal use without the written permission of IP Infusion Inc.

IP Infusion Inc.
3965 Freedom Circle, Suite 200
Santa Clara, CA 95054
+1 408-400-1900
<http://www.ipinfusion.com/>

For support, questions, or comments via E-mail, contact:
support@ipinfusion.com

Trademarks:

IP Infusion and OcNOS are trademarks or registered trademarks of IP Infusion. All other trademarks, service marks, registered trademarks, or registered service marks are the property of their respective owners.

Use of certain software included in this equipment is subject to the IP Infusion, Inc. End User License Agreement at <http://www.ipinfusion.com/license>. By using the equipment, you accept the terms of the End User License Agreement.

Contents

Preface	vii
Audience	vii
Conventions	vii
Chapter Organization	vii
Related Documentation	vii
Migration Guide	vii
Feature Availability	viii
Support	viii
Comments	viii
Command Line Interface	9
Overview	9
Command Line Interface Help	9
Command Completion	10
Command Abbreviations	10
Command Line Errors	10
Command Negation	11
Syntax Conventions	11
Variable Placeholders	12
Command Description Format	13
Keyboard Operations	13
Show Command Modifiers	14
String Parameters	17
Command Modes	17
Transaction-based Command-line Interface	19
Quality of Service Configuration Guide	21
CHAPTER 1 QoS Introduction	23
QoS Functionality	23
Terminology	23
Enable/Disable Configuration	26
Validation	27
QoS Statistics Configuration	27
CHAPTER 2 Dscp-to-queue Map Profile Configuration	29
Configuration of dscp-to-queue Map Profile on configuration mode	29
Configuration of dscp-to-queue Map Profile on Interface mode	30
CHAPTER 3 Cos-to-queue Map Configuration	33
Configuration of Cos-to-queue Map on configuration mode	33
Configuration of Cos-to-queue Map Profile on Interface mode	33
CHAPTER 4 Queue-color-to-cos Map Profile Configuration	37
Topology	37
Configuration of Queue-color-to-cos Map Profile on Interface mode	38

CHAPTER 5	Queue-color-to-dscp Map Profile Configuration	39
	Topology	39
	Configuration of Queue-color-to-dscp Map Profile on Interface mode	40
CHAPTER 6	Trust DSCP on Layer 2 Interface Configuration	41
	Configuration Trust DSCP on Interface mode	41
CHAPTER 7	Service based Queue Distribution Configuration	43
	Service based Queue configuration	43
CHAPTER 8	Weights for Queues Configuration	47
	Configuring WRR Weights for Queues	47
CHAPTER 9	Marking/Remarking Configuration.	57
	L2 Interface	57
	L3 Interface	63
CHAPTER 10	Policing Configuration	71
	L2 Interface	71
CHAPTER 11	Bandwidth Configuration	79
	Topology	79
	L2/L3 Interface	79
	Validation	80
CHAPTER 12	Shaping Configuration.	87
	Topology	87
	L2/L3 Interface	87
	Validation	88
CHAPTER 13	Scheduling Configuration	95
	Topology	95
	Configuring Weight on L2 /L3 Interface	95
	Validation	95
CHAPTER 14	WRED Configuration.	103
	L2/L3 Interface	103
	Validation	104
CHAPTER 15	Tail-Drop Configuration	109
	Topology	109
	Configuring Tail-Drop	109
	Validation	110
CHAPTER 16	Hierarchical Queuing Configuration	119
	Configuring Hierarchical Queuing	119
	Validation	125
CHAPTER 17	VXLAN Quality of Service	163
CHAPTER 18	FP Rules Queuing Configuration	165
	Configuring CPU Queuing Lossless	166
	Validation	166
	Configuring CPU Queuing Lossy	168

Validation.....	169
CHAPTER 19 Explicit Congestion Notification (ECN) Configuration	173
Configuring ECN on L3 Interface	174
Validation.....	175
Configuring ECN on L2 Interface.....	176
Validation.....	177
CHAPTER 20 Rate Limiting BUM Traffic	181
Quality of Service Command Reference	183
CHAPTER 1 Quality of Service Commands.....	185
bandwidth	187
class-map type qos	188
class-map type queuing	189
class type qos	190
class type queuing	191
clear qos statistics	192
cpu-queue	193
egress cos map	194
egress dscp map	195
ingress cos map	196
ingress dscp map	197
ingress exp map	198
Lossless.....	199
match access-group.....	200
match cos	201
match cos inner	202
match dscp	203
match ip rtp	205
match mac.....	206
match precedence	207
match protocol	208
match qos-group.....	209
match traffic-type	210
match vlan.....	211
match vlan inner	212
police	213
policy-map.....	216
priority	217
priority (queuing).....	218
qos (enable disable)	219
qos map-profile.....	220
qos profile	221
qos profile precedence-to-queue	223
qos profile queue-to-precedence	224
qos remark	225

qos statistics	226
queue-limit	227
random-detect	228
service-policy	230
service-policy type qos	231
service-policy type queuing	232
set bridge cos	233
set bridge dscp	234
set cos	236
set dscp	237
set mpls class	239
set precedence	240
set qos-group	241
set qos queue scheduler	242
set queue	243
shape	244
shape rate	245
show class-map	246
show cpu-queue details	247
show policy-map	249
show policy-map interface	251
show qos-profile	254
show qos-profile interface	256
show queuing interface	257
show running-config qos	258
show running-config cpu-queue	263
storm-control	264
trust dscp	266
wrr-queue weight	267
Index	269

Preface

This guide describes how to configure OcNOS.

Audience

This guide is intended for network administrators and other engineering professionals who configure OcNOS.

Conventions

[Table P-1](#) shows the conventions used in this guide.

Table P-1: Conventions

Convention	Description
<i>Italics</i>	Emphasized terms; titles of books
Note:	Special instructions, suggestions, or warnings
<code>monospaced type</code>	Code elements such as commands, parameters, files, and directories

Chapter Organization

The chapters in command references are organized as described in [Command Description Format](#).

The chapters in configuration guides are organized into these major sections:

- An overview that explains a configuration in words
- Topology with a diagram that shows the devices and connections used in the configuration
- Configuration steps in a table for each device where the left-hand side shows the commands you enter and the right-hand side explains the actions that the commands perform
- Validation which shows commands and their output that verify the configuration

Related Documentation

For information about installing of OcNOS, see the *Installation Guide* for your platform.

Migration Guide

Check the *Migration Guide* for configuration changes to make when migrating from one version of OcNOS to another.

Feature Availability

The features described in this document that are available depend upon the OcNOS SKU that you purchased. See the *Feature Matrix* for a description of the OcNOS SKUs.

Support

For support-related questions, contact support@ipinfusion.com.

Comments

If you have comments, or need to report a problem with the content, contact techpubs@ipinfusion.com.

Command Line Interface

This chapter introduces the OcNOS Command Line Interface (CLI) and how to use its features.

Overview

You use the CLI to configure, monitor, and maintain OcNOS devices. The CLI is text-based and each command is usually associated with a specific task.

You can give the commands described in this manual locally from the console of a device running OcNOS or remotely from a terminal emulator such as `putty` or `xterm`. You can also use the commands in scripts to automate configuration tasks.

Command Line Interface Help

You access the CLI help by entering a full or partial command string and a question mark “?”. The CLI displays the command keywords or parameters along with a short description. For example, at the CLI command prompt, type:

```
> show ?
```

The CLI displays this keyword list with short descriptions for each keyword:

```
show ?
  application-priority      Application Priority
  arp                      Internet Protocol (IP)
  bfd                      Bidirectional Forwarding Detection (BFD)
  bgp                      Border Gateway Protocol (BGP)
  bi-lsp                   Bi-directional lsp status and configuration
  bridge                   Bridge group commands
  ce-vlan                  COS Preservation for Customer Edge VLAN
  class-map                Class map entry
  cli                     Show CLI tree of current mode
  clns                    Connectionless-Mode Network Service (CLNS)
  control-adjacency       Control Adjacency status and configuration
  control-channel         Control Channel status and configuration
  cspf                    CSPF Information
  customer                Display Customer spanning-tree
  cvlan                   Display CVLAN information
  debugging               Debugging functions (see also 'undebug')
  etherchannel            LACP etherchannel
  ethernet                Layer-2
  ...
```

If you type the ? in the middle of a keyword, the CLI displays help for that keyword only.

```
> show de?
  debugging Debugging functions (see also 'undebug')
```

If you type the ? in the middle of a keyword, but the incomplete keyword matches several other keywords, OcNOS displays help for all matching keywords.

```
> show i? (CLI does not display the question mark).
interface Interface status and configuration
ip IP information
isis ISIS information
```

Command Completion

The CLI can complete the spelling of a command or a parameter. Begin typing the command or parameter and then press the tab key. For example, at the CLI command prompt type `sh`:

```
> sh
```

Press the tab key. The CLI displays:

```
> show
```

If the spelling of a command or parameter is ambiguous, the CLI displays the choices that match the abbreviation. Type `show i` and press the tab key. The CLI displays:

```
> show i
  interface ip          ipv6      isis
> show i
```

The CLI displays the `interface` and `ip` keywords. Type `n` to select `interface` and press the tab key. The CLI displays:

```
> show in
> show interface
```

Type `?` and the CLI displays the list of parameters for the `show interface` command.

```
> show interface
  IFNAME  Interface name
  |       Output modifiers
  >      Output redirection
  <cr>
```

The CLI displays the only parameter associated with this command, the `IFNAME` parameter.

Command Abbreviations

The CLI accepts abbreviations that uniquely identify a keyword in commands. For example:

```
> sh int xe0
```

is an abbreviation for:

```
> show interface xe0
```

Command Line Errors

Any unknown spelling causes the CLI to display the error `Unrecognized command` in response to the `?`. The CLI displays the command again as last entered.

```
> show dd?
% Unrecognized command
> show dd
```

When you press the Enter key after typing an invalid command, the CLI displays:

```
(config)#router ospf here
                               ^
% Invalid input detected at '^' marker.
```

where the `^` points to the first character in error in the command.

If a command is incomplete, the CLI displays the following message:

```
> show
% Incomplete command.
```

Some commands are too long for the display line and can wrap mid-parameter or mid-keyword, as shown below. This does *not* cause an error and the command performs as expected:

```
area 10.10.0.18 virtual-link 10.10.0.19 authent
ication-key 57393
```

Command Negation

Many commands have a `no` form that resets a feature to its default value or disables the feature. For example:

- The `ip address` command assigns an IPv4 address to an interface
- The `no ip address` command removes an IPv4 address from an interface

Syntax Conventions

[Table P-2](#) describes the conventions used to represent command syntax in this reference.

Table P-2: Syntax conventions

Convention	Description	Example
monospaced font	Command strings entered on a command line	<code>show ip ospf</code>
lowercase	Keywords that you enter exactly as shown in the command syntax.	<code>show ip ospf</code>
UPPERCASE	See Variable Placeholders	<code>IFNAME</code>
()	Optional parameters, from which you must select one. Vertical bars delimit the selections. Do not enter the parentheses or vertical bars as part of the command.	<code>(A.B.C.D <0-4294967295>)</code>
()	Optional parameters, from which you select one or none. Vertical bars delimit the selections. Do not enter the parentheses or vertical bars as part of the command.	<code>(A.B.C.D <0-4294967295>)</code>
()	Optional parameter which you can specify or omit. Do not enter the parentheses or vertical bar as part of the command.	<code>(IFNAME)</code>
{ }	Optional parameters, from which you must select one or more. Vertical bars delimit the selections. Do not enter the braces or vertical bars as part of the command.	<code>{intra-area <1-255> inter-area <1-255> external <1-255>}</code>

Table P-2: Syntax conventions (Continued)

Convention	Description	Example
[]	Optional parameters, from which you select zero or more. Vertical bars delimit the selections. Do not enter the brackets or vertical bars as part of the command.	[<1-65535> AA:NN internet local-AS no-advertise no-export]
?	Nonrepeatable parameter. The parameter that follows a question mark can only appear once in a command string. Do not enter the question mark as part of the command.	?route-map WORD
.	Repeatable parameter. The parameter that follows a period can be repeated more than once. Do not enter the period as part of the command.	set as-path prepend .<1-65535>

Variable Placeholders

Table P-3 shows the tokens used in command syntax use to represent variables for which you supply a value.

Table P-3: Variable placeholders

Token	Description
WORD	A contiguous text string (excluding spaces)
LINE	A text string, including spaces; no other parameters can follow this parameter
IFNAME	Interface name whose format varies depending on the platform; examples are: eth0, Ethernet0, ethernet0, xe0
A.B.C.D	IPv4 address
A.B.C.D/M	IPv4 address and mask/prefix
X:X::X:X	IPv6 address
X:X::X:X/M	IPv6 address and mask/prefix
HH:MM:SS	Time format
AA:NN	BGP community value
XX:XX:XX:XX:XX:XX	MAC address
<1-5> <1-65535> <0-2147483647> <0-4294967295>	Numeric range

Command Description Format

Table P-4 explains the sections used to describe each command in this reference.

Table P-4: Command descriptions

Section	Description
Command Name	The name of the command, followed by what the command does and when should it be used
Command Syntax	The syntax of the command
Parameters	Parameters and options for the command
Default	The state before the command is executed
Command Mode	The mode in which the command runs; see Command Modes
Example	An example of the command being executed

Keyboard Operations

Table P-5 lists the operations you can perform from the keyboard.

Table P-5: Keyboard operations

Key combination	Operation
Left arrow or Ctrl+b	Moves one character to the left. When a command extends beyond a single line, you can press left arrow or Ctrl+b repeatedly to scroll toward the beginning of the line, or you can press Ctrl+a to go directly to the beginning of the line.
Right arrow or Ctrl-f	Moves one character to the right. When a command extends beyond a single line, you can press right arrow or Ctrl+f repeatedly to scroll toward the end of the line, or you can press Ctrl+e to go directly to the end of the line.
Esc, b	Moves back one word
Esc, f	Moves forward one word
Ctrl+e	Moves to end of the line
Ctrl+a	Moves to the beginning of the line
Ctrl+u	Deletes the line
Ctrl+w	Deletes from the cursor to the previous whitespace
Alt+d	Deletes the current word
Ctrl+k	Deletes from the cursor to the end of line
Ctrl+y	Pastes text previously deleted with Ctrl+k, Alt+d, Ctrl+w, or Ctrl+u at the cursor

Table P-5: Keyboard operations (Continued)

Key combination	Operation
Ctrl+t	Transposes the current character with the previous character
Ctrl+c	Ignores the current line and redisplay the command prompt
Ctrl+z	Ends configuration mode and returns to exec mode
Ctrl+l	Clears the screen
Up Arrow or Ctrl+p	Scroll backward through command history
Down Arrow or Ctrl+n	Scroll forward through command history

Show Command Modifiers

You can use two tokens to modify the output of a `show` command. Enter a question mark to display these tokens:

```
# show users ?
  | Output modifiers
  > Output redirection
```

You can type the | (vertical bar character) to use output modifiers. For example:

```
> show rsvp | ?
begin      Begin with the line that matches
exclude    Exclude lines that match
include    Include lines that match
last       Last few lines
redirect   Redirect output
```

Begin Modifier

The `begin` modifier displays the output beginning with the first line that contains the input string (everything typed after the `begin` keyword). For example:

```
# show running-config | begin xe1
...skipping
interface xe1
  ipv6 address fe80::204:75ff:fee6:5393/64
!
interface xe2
  ipv6 address fe80::20d:56ff:fe96:725a/64
!
line con 0
  login
!
end
```

You can specify a regular expression after the `begin` keyword. This example begins the output at a line with either “xe2” or “xe4”:

```
# show running-config | begin xe[3-4]
...skipping
```

```

interface xe3
 shutdown
!
interface xe4
 shutdown
!
interface svlan0.1
 no shutdown
!
route-map myroute permit 3
!
route-map mymap1 permit 10
!
route-map rmap1 permit 3
!
line con 0
 login
line vty 0 4
 login
!
end

```

Include Modifier

The `include` modifier includes only those lines of output that contain the input string. In the output below, all lines containing the word “input” are included:

```

# show interface xe1 | include input
input packets 80434552, bytes 2147483647, dropped 0, multicast packets 0
input errors 0, length 0, overrun 0, CRC 0, frame 0, fifo 1, missed 0

```

You can specify a regular expression after the `include` keyword. This examples includes all lines with “input” or “output”:

```

#show interface xe0 | include (in|out)put
input packets 597058, bytes 338081476, dropped 0, multicast packets 0
input errors 0, length 0, overrun 0, CRC 0, frame 0, fifo 0, missed 0
output packets 613147, bytes 126055987, dropped 0
output errors 0, aborted 0, carrier 0, fifo 0, heartbeat 0, window 0

```

Exclude Modifier

The `exclude` modifier excludes all lines of output that contain the input string. In the following output example, all lines containing the word “input” are excluded:

```

# show interface xe1 | exclude input
Interface xe1
Scope: both
Hardware is Ethernet, address is 0004.75e6.5393
index 3 metric 1 mtu 1500 <UP,BROADCAST,RUNNING,MULTICAST>
VRF Binding: Not bound
Administrative Group(s): None
DSTE Bandwidth Constraint Mode is MAM
inet6 fe80::204:75ff:fee6:5393/64
output packets 4438, bytes 394940, dropped 0
output errors 0, aborted 0, carrier 0, fifo 0, heartbeat 0, window 0
collisions 0

```

You can specify a regular expression after the `exclude` keyword. This example excludes lines with “output” or “input”:

```
# show interface xe0 | exclude (in|out)put
Interface xe0
  Scope: both
  Hardware is Ethernet Current HW addr: 001b.2139.6c4a
  Physical:001b.2139.6c4a Logical:(not set)
  index 2 metric 1 mtu 1500 duplex-full arp ageing timeout 3000
  <UP,BROADCAST,RUNNING,MULTICAST>
  VRF Binding: Not bound
  Bandwidth 100m
  DHCP client is disabled.
  inet 10.1.2.173/24 broadcast 10.1.2.255
  VRRP Master of : VRRP is not configured on this interface.
  inet6 fe80::21b:21ff:fe39:6c4a/64
  collisions 0
```

Redirect Modifier

The `redirect` modifier writes the output into a file. The output is not displayed.

```
# show cli history | redirect /var/frame.txt
```

The output redirection token (`>`) does the same thing:

```
# show cli history >/var/frame.txt
```

Last Modifier

The `last` modifier displays the output of last few number of lines (As per the user input). The last number ranges from 1 to 9999.

For example:

```
#show running-config | last 10
```

String Parameters

The restrictions in [Table P-6](#) apply for all string parameters used in OcnOS commands, unless some other restrictions are noted for a particular command.

Table P-6: String parameter restrictions

Restriction	Description
Input length	1965 characters or less
Restricted special characters	“?”, “,”, “>”, “ ”, and “=” The “ ” is allowed only for <code>description</code> CLI in interface mode.

Command Modes

Commands are grouped into modes arranged in a hierarchy. Each mode has its own set of commands. [Table P-7](#) lists the command modes common to all protocols.

Table P-7: Common command modes

Name	Description
Executive mode	Also called <i>view</i> mode, this is the first mode to appear after you start the CLI. It is a base mode from where you can perform basic commands such as <code>show</code> , <code>exit</code> , <code>quit</code> , <code>help</code> , and <code>enable</code> .
Privileged executive mode	Also called <i>enable</i> mode, in this mode you can run additional basic commands such as <code>debug</code> , <code>write</code> , and <code>show</code> .
Configure mode	Also called <i>configure terminal</i> mode, in this mode you can run configuration commands and go into other modes such as interface, router, route map, key chain, and address family. Configure mode is single user. Only one user at a time can be in configure mode.
Interface mode	In this mode you can configure protocol-specific settings for a particular interface. Any setting you configure in this mode overrides a setting configured in router mode.
Router mode	This mode is used to configure router-specific settings for a protocol such as BGP or OSPF.

Command Mode Tree

The diagram below shows the common command mode hierarchy.

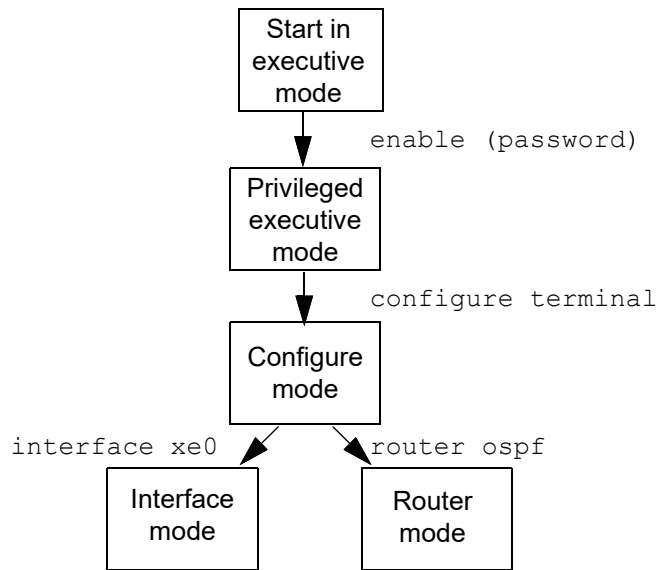

Figure P-1: Common command modes

To change modes:

1. Enter privileged executive mode by entering `enable` in Executive mode.
2. Enter configure mode by entering `configure terminal` in Privileged Executive mode.

The example below shows moving from executive mode to privileged executive mode to configure mode and finally to router mode:

```

> enable mypassword
# configure terminal
Enter configuration commands, one per line. End with CNTL/Z.
(config)# router ospf
(config-router)#
  
```

Note: Each protocol can have modes in addition to the common command modes. See the command reference for the respective protocol for details.

Transaction-based Command-line Interface

The OcNOS command line interface is transaction based:

- Any changes done in configure mode are stored in a separate *candidate* configuration that you can view with the `show transaction current` command.
- When a configuration is complete, apply the candidate configuration to the running configuration with the `commit` command.
- If a `commit` fails, no configuration is applied as the entire transaction is considered failed. You can continue to change the candidate configuration and then retry the `commit`.
- Discard the candidate configuration with the `abort transaction` command.
- Check the last aborted transaction with the `show transaction last-aborted` command.
- Multiple configurations cannot be removed with a single commit. You must remove each configuration followed by a commit.

Note: All commands MUST be executed only in the default CML shell (`cmlsh`). If you log in as `root` and start `imish` then the system configurations will go out of sync. The `imish` shell is not supported and should not be started manually.

Quality of Service Configuration Guide

CHAPTER 1 QoS Introduction

This chapter contains a general overview of QoS functionality and terminology.

QoS Functionality

Quality of Service (QoS) can be used to give certain traffic priority over other traffic. Without QoS, all traffic in a network has the same priority and chance of being delivered on time. If congestion occurs, all traffic has the same chance of being dropped. With QoS, specific network traffic can be prioritized to receive preferential treatment. In turn, a network performs more predictably, and utilizes bandwidth more effectively.

QoS is based on DiffServ architecture, which stipulates that individual packets be classified upon entry into a network. Classification information can be carried in the Layer-3 IP packet header or the Layer-2 frame. IP packet headers carry the information using 6-bits from the deprecated IP type of service (TOS) field. Layer-2 802.1Q frames carry the information using a 2-byte Tag Control Information field. All switches and routers accessing the Internet depend on class information to give the same forwarding treatment to packets with the same class information, and give different treatment to packets with different class information. A packet can be assigned class information, as follows:

- End hosts or switches along a path, based on a configured policy
- Detailed packet examination, expected to occur nearer to the network edge, to prevent overloading core switches and routers
- A combination of the above two techniques

Class information can be used by switches and routers along a path to limit the amount of allotted resources per traffic class. Per-hop behavior is an individual device's behavior when handling traffic in the DiffServ architecture. An end-to-end QoS solution can be created if all devices along a path have consistent per-hop behavior.

Terminology

Following is a brief description of terms and concepts used to describe QoS.

ACL

Access control lists (ACLs) classify traffic with the same characteristics. IP traffic is classified using IP standard or IP extended ACLs. The ACL can have multiple access control entries (ACEs), which are commands that match fields against the contents of the packet. It is not possible to match IP fragments against configured IP extended ACLs to enforce QoS, but it is possible to match IP options against configured IP extended ACLs to enforce QoS.

CoS Value

Class of Service (CoS) is a 3-bit value used to classify the priority of Layer-2 frames upon entry into a network. QoS classifies frames by assigning priority-indexed CoS values to them, and gives preference to higher-priority traffic. Layer-2 802.1Q frame headers have a 2-byte Tag Control Information field that carries the CoS value in the three most-significant bits, called the User Priority bits. On interfaces configured as Layer-2 802.1Q trunks, all traffic is in 802.1Q frames, except for traffic in the native VLAN. Other frame types cannot carry Layer-2 CoS values. CoS values range from zero to seven, seven being the highest priority.

DSCP Value

Differentiated Services Code Point (DSCP) is a 6-bit value used to classify the priority of Layer-3 packets upon entry into a network. DSCP values range from 0 to 63, 63 being the highest priority, 0 being best-effort traffic.

Classification

Classification distinguishes one kind of traffic from another by examining the fields in the packet. The process generates an internal DSCP for a packet, which identifies all future QoS actions to be taken on the packet. Each packet is classified upon entry into the network. At the ingress, the packet is inspected, and the DSCP is determined based on ACLs or the configuration. The Layer-2 CoS value is then mapped to a DSCP value. The classification is carried in the IP packet header using 6 bits from the deprecated IP TOS field to carry the classification information. Classification can also occur in the Layer-2 frame. Classification is enabled only if QoS is globally enabled on the switch. By default, QoS is globally disabled, thus, no classification occurs. Classification occurs on an ingress physical port, but not at the switch virtual interface level. Classification can be based on QoS ACLs, or class maps and policy maps.

Policing

Policing determines whether a packet is in or out of profile by comparing the internal DSCP to the configured policer. Policer limits the bandwidth consumed by a traffic flow with the results given to the marker. The two types of policers:

- Individual: QoS applies the bandwidth limits specified in the policer, separately, to each matched traffic class. An individual policer is configured within a policy map.
- Aggregate: QoS applies the bandwidth limits specified in an aggregate policer, cumulatively, to all matched traffic flows. An aggregate policer is configured by specifying the policer name within a policy map. The bandwidth limits of the policer are specified. In this way, multiple classes of traffic across policy map share the aggregate policer.

Policing and policers have the following attributes:

- Policers can occur only on a physical port basis.
- Policing can occur on ingress interfaces.
- Only one policer can be applied to a packet per direction.

Marking

Marking determines how to handle a packet when it is out of profile. It assesses the policer and the configuration data to determine the action required for the packet, and then handles the packet using one of the following methods:

- Let the packet through without modification
- Drop the packet

Marking can occur on ingress and egress interfaces.

Queuing

Queuing maps packets to a CoS queue. Each egress port can accommodate up to 8 CoS queues, prioritized as 0 lowest and 7 highest. The tagged packet incoming priority can be mapped to one of the 8 queues obtained from the filtering mechanism result. The untagged packet CoS priority is also obtained from the filtering mechanism result. After the packets are mapped to a CoS queue, they are scheduled.

Bandwidth Reservation

Bandwidth reservation is the minimum guaranteed bandwidth allocated per queue. Total guaranteed bandwidth of all the queues belonging to a particular port should not exceed the interface Bandwidth. In case if no Bandwidth reservation is done for the queue, minimum guaranteed per each queue will be 1% of the parent node [scheduling node or interface]

Scheduling

Scheduling forwards or conditions packets using one of the following methods:

- Strict Priority-Based (SP), in which any high-priority packets are first transmitted. Lower-priority packets are transmitted only when the higher-priority queues are empty. A problem may occur when too many lower-priority packets are not transmitted. Strict Priority will be operating on the remaining bandwidth available for the Port
- Weighted Round Robin (WRR), in which each queue is assigned a weight to control the number of packets relatively sent from each queue. The weights assigned for the queues will be in the ratio of bandwidth reservation of those queues
- Combination of WRR and SP, the Remaining Bandwidth will be scheduled in the strict order for the SP Queues. The Remaining Bandwidth will be scheduled in the WRR mode for WRR Queues.

Class Map

A class map names and isolates specific traffic from other traffic. The class map defines the criteria used to match against a specific traffic flow to classify it further. The criteria can include:

- Matching the access group defined by the ACL
- Matching a specific list of DSCP values

If there is more than one type of traffic to be classified, another class map can be created under a different name. After a packet is matched against the class-map criteria, it is further classified using a policy map.

Policy Map

A policy map specifies on which traffic class to act. This can be implemented as follows:

- Set a specific CoS or DSCP value in the traffic class.
- Specify the traffic bandwidth limitations for each matched traffic class (policer) and the action to take (marking) when the traffic is out of profile.

Policy maps have the following attributes:

- A policy map can contain multiple class statements, each with different match criteria and policers.
- A separate policy-map class can exist for each type of traffic received through an interface.
- There can be only one policy map per interface per direction. The same policy map can be applied to multiple interfaces and directions.
- Before a policy map can be effective, it must be attached to an interface.

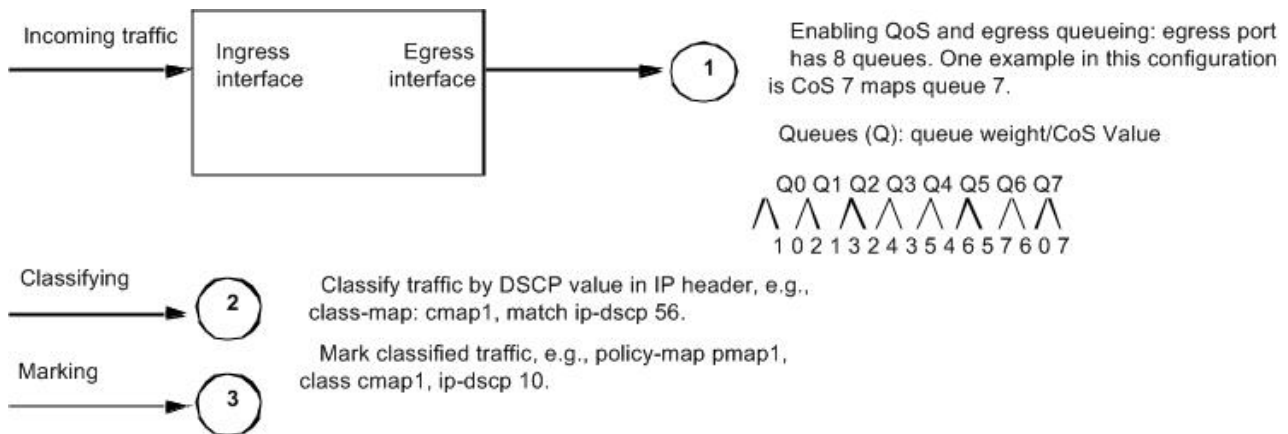

Enable/Disable Configuration

Topology



Figure 1-1: Simple configuration of QoS

Enabling QoS

The following steps describe how to enable QoS.

#configure terminal	Enter configure mode.
(config)#qos enable	Enable (H)QoS on configuration mode.
(config)#exit	Exit configure mode.

Validation

Enter the commands below to confirm the configurations.

```
#show running-config qos
qos enable
!
```

Disabling QoS

The following steps disable QoS.

#configure terminal	Enter configure mode.
(config)#qos disable	Disable (H)QoS on configuration mode.
(config)#exit	Exit configure mode.

Validation

Enter the commands below to confirm the configurations.

```
#show running-config qos
% QoS is not enabled globally
```

QoS Statistics Configuration

This section show how to enable QoS statistics.

Topology



Figure 1-2: Simple configuration of QoS

Enabling QoS Statistics

The following steps describe how to enable QoS Statistics.

#configure terminal	Enter configure mode.
(config)#qos enable	Enable QoS globally.
(config)#qos statistics	Enable QoS statistics on configuration mode.
(config)#exit	Exit configure mode.

Validation

Enter the commands below to confirm the configurations.

```
#show running-config qos
qos enable
qos statistics
!
```

CHAPTER 2 Dscp-to-queue Map Profile Configuration

This chapter contains a complete sample of configuring Dscp-to-queue map profile.

Topology

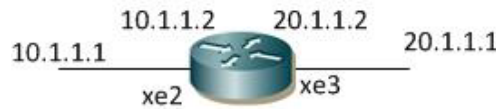

Figure 2-3: Simple configuration of Dscp-to-queue map

Configuration of dscp-to-queue Map Profile on configuration mode

The following steps describe how to configure dscp-to-queue map on configuration mode.

#configure terminal	Enter configure mode.
(config)#qos enable	Enable QoS globally.
(config)#qos statistics	Enable QoS statistics.
(config)#qos profile dscp-to-queue Profile1	Enter Dscp to queue map profile configuration mode
(config)#qos profile dscp-to-queue Dscp2queue	Enter dscp-to-queue profile configuration mode
(config-ingress-dscp-map)#dscp 10 queue 5	Map dscp 10 to queue 5
(config-ingress-dscp-map)#exit	Exit dscp-to-queue profile configure mode.
(config)#qos profile dscp-to-queue Profile3	Enter Dscp to queue map profile configuration mode
(config-ingress-dscp-map)#dscp 24 queue 6 color green	Map dscp 24 to queue 6 for green packets
(config-ingress-dscp-map)#exit	Exit dscp-to-queue profile configure mode
(config)#exit	Exit configure mode.

Validation

Enter the commands below to confirm the configurations.

```
#show running-config qos
qos enable
qos statistics
!
qos profile dscp-to-queue Profile1
  dscp 10 queue 5
!
qos profile dscp-to-queue Profile3
  dscp 24 queue 6 color green
```

Configuration of dscp-to-queue Map Profile on Interface mode

The following steps describe how to configure dscp-to-queue map profile on interface mode.

#configure terminal	Enter configure mode.
(config)#qos enable	Enable QoS globally.
(config)#qos statistics	Enable QoS statistics.
(config)#interface xe2	Enter interface mode.
(config-if)#qos map-profile dscp-to-queue Profile1	Map dscp-to-queue profile to the interface
(config-if)#exit	Exit interface mode.
(config)#exit	Exit configure mode.
(config)#interface xe3	Enter interface mode,
(config-if)#qos map-profile dscp-to-queue Profile3	Map dscp-to-queue profile to the interface
(config-if)#exit	Exit interface mode

Validation

Enter the commands below to confirm the configurations.

```
#show running-config qos
qos enable
qos statistics
!
qos profile dscp-to-queue Profile1
  dscp 10 queue 5
!
!
!
interface xe2
  qos map-profile dscp-to-queue Profile1
!
interface xe3
  qos map-profile dscp-to-queue Profile3
!
```

```
#show qos-profile type dscp-to-queue Profile1
profile name: Profile1
profile type: dscp-to-queue
profile attached to 1 instances
configured mapping:
  dscp 10 queue 5
Detailed mapping:
```

Ingress map for dscp to queue-color

INPUT			OUTPUT			INPUT			OUTPUT			INPUT			OUTPUT		
DSCP	Queue	Color	DSCP	Queue	Color	DSCP	Queue	Color	DSCP	Queue	Color	DSCP	Queue	Color	DSCP	Queue	Color
0	0	green	16	2	green	32	4	green	48	6	green						
1	0	green	17	2	green	33	4	green	49	6	green						
2	0	green	18	2	green	34	4	green	50	6	green						
3	0	green	19	2	green	35	4	green	51	6	green						

4	0	green		20	2	yellow		36	4	yellow		52	6	green
5	0	green		21	2	green		37	4	green		53	6	green
6	0	green		22	2	red		38	4	red		54	6	green
7	0	green		23	2	green		39	4	green		55	6	green
8	1	green		24	3	green		40	5	green		56	7	green
9	1	green		25	3	green		41	5	green		57	7	green
10	5	green		26	3	green		42	5	green		58	7	green
11	1	green		27	3	green		43	5	green		59	7	green
12	1	yellow		28	3	yellow		44	5	green		60	7	green
13	1	green		29	3	green		45	5	green		61	7	green
14	1	red		30	3	red		46	5	green		62	7	green
15	1	green		31	3	green		47	5	green		63	7	green

CHAPTER 3 Cos-to-queue Map Configuration

This chapter contains a complete sample of configuring Cos-to-queue map.

Topology



Figure 3-4: Simple configuration of CoS

Configuration of Cos-to-queue Map on configuration mode

The following steps describe how to configure Cos-to-queue map on configuration mode.

#configure terminal	Enter configure mode.
(config)#qos enable	Enable QoS globally.
(config)#qos statistics	Enable QoS statistics.
(config)#qos profile cos-to-queue Profile2	Enter cos-to-queue profile configuration mode
(config-ingress-cos-map)#cos 2 queue 4	Map cos 2 to queue 4 under cos-to-queue profile configuration mode
(config-ingress-cos-map)#exit	Exit configure mode.
(config)#qos profile cos-to-queue Profile4	Enter cos-to-queue profile configuration mode
(config-ingress-cos-map)#cos 3 queue 4 color yellow	Map cos 3 to queue 4 for yellow packets
(config-ingress-cos-map)#exit	Exit cos-to-queue map profile configuration
(config)#exit	Exit configure mode.

Validation

Enter the commands below to confirm the configurations.

```

#show running-config qos qos enable
qos statistics
!
qos profile cos-to-queue Profile2
  cos 2 dei all queue 4
qos map cos 2 queue 4
!
qos profile cos-to-queue Profile4
  cos 3 dei all queue 4 color yellow
!
  
```

Configuration of Cos-to-queue Map Profile on Interface mode

The following steps describe how to configure Cos-to-queue map profile on interface mode.

#configure terminal	Enter configure mode.
(config)#qos enable	Enable QoS globally.
(config)#qos statistics	Enable QoS statistics.
(config)#interface xe2	Enter interface mode.
(config-if)#switchport	Configure the port as switchport
(config-if)#qos map-profile cos-to-queue Profile2	Map cos-to-queue profile on the interface
(config-if)#exit	Exit interface mode.
(config)#exit	Exit configure mode.
(config)#interface xe3	Enter interface mode.
(config-if)#switchport	Configure the port as switchport
(config-if)#qos map-profile cos-to-queue Profile4	Map cos-to-queue profile on the interface
(config-if)#exit	Exit interface mode.
(config)#exit	Exit configure mode.

Validation

Enter the commands below to confirm the configurations.

```
#show running-config qos
qos enable
qos statistics
!
qos profile cos-to-queue Profile2
  cos 2 dei all queue 4
!
!
!
interface ce3/1
  qos map-profile cos-to-queue Profile2
!
qos profile cos-to-queue Profile4
  cos 3 dei all queue 4 color yellow
!
!
#show qos-profile type cos-to-queue Profile4
profile name: Profile4
profile type: cos-to-queue
profile attached to 0 instances
configured mapping:
  cos 3 dei all queue 4 color yellow
Detailed mapping:
```

INPUT				OUTPUT			
COS	DEI	Queue	Color	COS	DEI	Queue	Color
0	0	0	green	0	1	0	yellow
1	0	1	green	1	1	1	yellow

2	0	2	green		2	1	2	yellow
3	0	4	yellow		3	1	4	yellow
4	0	4	green		4	1	4	yellow
5	0	5	green		5	1	5	yellow
6	0	6	green		6	1	6	yellow
7	0	7	green		7	1	7	yellow

CHAPTER 4 Queue-color-to-cos Map Profile Configuration

This chapter contains a complete sample of configuring queue-color-to-cos map profile.

Topology

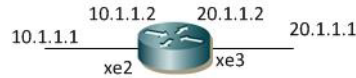

Figure 4-5: Queue color-to-cos map profile configuration

Configuration queue-color-to-qos map profile

The following steps describe how to configure queue-color-to-cos map profile on configuration mode.

#configure terminal	Enter configure mode.
(config)#qos enable	Enable QoS globally.
(config)#qos statistics	Enable QoS statistics.
(config)#qos profile queue-color-to-cos Profile5	Enter queue-color-to-cos profile configuration mode
(config-ingress-cos-map)#queue 2 color all cos 7	Map queue 2 to cos 7 for all colors under cos-to-queue profile configuration mode
(config-egress-cos-map)#exit	Exit queue-color-to-cos configuration mode
(config)#qos profile queue-color-to-cos default	Enter queue-color-to-cos default map profile configuration mode
(config-egress-cos-map)#queue 3 cos 5	Map queue 3 frames to cos 5
(config-egress-cos-map)#exit	Exit queue-color-to-cos
(config)#exit	Exit configure mode.

Validation

Enter the commands below to confirm the configurations.

```
#show running-config qos
qos enable
qos statistics
!
qos profile queue-color-to-cos default
  queue 3 color all cos 5
!
qos profile queue-color-to-cos Profile5
  queue 2 color all cos 7
!
```

Configuration of Queue-color-to-cos Map Profile on Interface mode

The following steps describe how to configure Queue-color-to-cos map profile on interface mode.

#configure terminal	Enter configure mode.
(config)#qos enable	Enable QoS globally.
(config)#qos statistics	Enable QoS statistics.
(config)#interface xe2	Enter interface mode.
(config-if)#switchport	Configure the port as switchport
(config-if)#qos map-profile queue-color-to-cos Profile5	map queue-color-to-cos profile on the interface
(config-if)#exit	Exit interface mode.
(config)#exit	Exit configure mode.

Validation

Enter the commands below to confirm the configurations.

```
# show running-config qos
qos enable
qos statistics
!
qos profile queue-color-to-cos default
  queue 3 color all cos 5
!
qos profile queue-color-to-cos Profile5
  queue 2 color all cos 7
!
!
!
interface xe2
  qos map-profile queue-color-to-cos Profile5
!
```

```
#show qos-profile type queue-color-to-cos Profile5
profile name: Profile5
profile type: queue-color-to-cos
profile attached to 1 instances
configured mapping:
  queue 2 color all cos 7
Detailed mapping:
```

INPUT			OUTPUT			INPUT			OUTPUT		
Queue	Color	COS	Queue	Color	COS	Queue	Color	COS	Queue	Color	COS
0	green	0	0	yellow	0	0	red	0	0	red	0
1	green	1	1	yellow	1	1	red	1	1	red	1
2	green	7	2	yellow	7	2	red	7	2	red	7
3	green	3	3	yellow	3	3	red	3	3	red	3
4	green	4	4	yellow	4	4	red	4	4	red	4
5	green	5	5	yellow	5	5	red	5	5	red	5
6	green	6	6	yellow	6	6	red	6	6	red	6
7	green	7	7	yellow	7	7	red	7	7	red	7

CHAPTER 5 Queue-color-to-dscp Map Profile Configuration

This chapter contains a complete sample of configuring queue-color-to-dscp map profile.

Topology

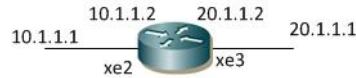

Figure 5-6: Queue color-to-dscp map profile configuration

Configuration queue-color-to-dscp map profile

The following steps describe how to configure queue-color-to-dscp map profile on configuration mode.

#configure terminal	Enter configure mode.
(config)#qos enable	Enable QoS globally.
(config)#qos statistics	Enable QoS statistics.
(config)#qos profile queue-color-to-dscp Profile6	Enter queue-color-to-dscp profile configuration mode
(config-egress-dscp-map)#queue 3 color green dscp 48	Map queue 3 to dscp 48 for green color traffic under queue-color-to-dscp profile configuration mode
(config-egress-dscp-map)#exit	Exit queue-color-to-dscp map configuration mode
(config)#qos profile queue-color-to-dscp default	Enter queue-color-to-dscp default map profile configuration mode
(config-egress-dscp-map)#queue 5 dscp 32	Map queue 5 frames to dscp 32
(config-egress-cos-map)#exit	Exit queue-color-to-dscp configuration mode
(config)#exit	Exit configure mode.

Validation

Enter the commands below to confirm the configurations.

```

#show running-config qos
qos enable
qos statistics
!
qos profile queue-color-to-dscp default
  queue 5 color all dscp 32
!
qos profile queue-color-to-dscp Profile6
  queue 3 color green dscp 48
! ?
  
```

Configuration of Queue-color-to-dscp Map Profile on Interface mode

The following steps describe how to configure Queue-color-to-dscp map profile on interface mode.

#configure terminal	Enter configure mode.
(config)#qos enable	Enable QoS globally.
(config)#qos statistics	Enable QoS statistics.
(config)#interface xe2	Enter interface mode.
(config-if)#switchport	Configure the port as switchport
(config-if)#qos map-profile queue-color-to-dscp Profile6	map queue-color-to-dscp profile on the interface
(config-if)#exit	Exit interface mode.
(config)#exit	Exit configure mode.

Validation

Enter the commands below to confirm the configurations.

```
# show running-config qos
qos enable
qos statistics
!
qos profile queue-color-to-dscp default
  queue 5 color all dscp 32
!
qos profile queue-color-to-dscp Profile6
  queue 3 color green dscp 48
!
!
!
interface xe2
  qos map-profile queue-color-to-dscp Profile6
!
#show qos-profile type queue-color-to-dscp Profile6
profile name: Profile6
profile type: queue-color-to-dscp
profile attached to 1 instances
configured mapping:
  queue 3 color green dscp 48
Detailed mapping:
```

INPUT			OUTPUT			INPUT			OUTPUT		
Queue	Color	DSCP	Queue	Color	DSCP	Queue	Color	DSCP	Queue	Color	DSCP
0	green	0	0	yellow	0	0	red	0			
1	green	10	1	yellow	12	1	red	14			
2	green	18	2	yellow	20	2	red	22			
3	green	48	3	yellow	28	3	red	30			
4	green	34	4	yellow	36	4	red	38			
5	green	40	5	yellow	40	5	red	40			
6	green	48	6	yellow	48	6	red	48			
7	green	56	7	yellow	56	7	red	56			

CHAPTER 6 Trust DSCP on Layer 2 Interface Configuration

This chapter contains a complete sample of configuring trust DSCP on Layer 2 interface.

Note: In case of vlan interface, for routed traffic, ingress qos mapping will be decided based upon the trust of member interface. With no trust set, applicable map will be cos map for routed traffic, and with trust set, applicable map will be dscp map.

Topology

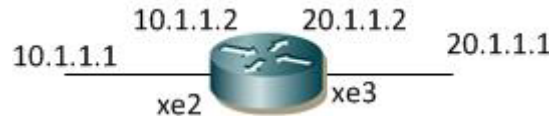

Figure 6-7: Simple configuration of trust DSCP

Configuration Trust DSCP on Interface mode

The following steps describe how to configure trust DSCP on Layer 2 interface. By default, Layer 2 interface will be trust CoS and layer3 interface will be trust DSCP.

#configure terminal	Enter configure mode.
(config)#qos enable	Enable QoS globally.
(config)#qos statistics	Enable QoS statistics.
(config)#interface xe2	Enter interface mode.
(config-if)#trust dscp	Configure trust DSCP on the interface xe2.
(config-if)#exit	Exit interface mode.
(config)#exit	Exit configure mode.

Validation

Enter the commands below to confirm the configurations.

```
#show running-config qos
qos enable
qos statistics
!
!
interface xe2
trust dscp
```

CHAPTER 7 Service based Queue Distribution Configuration

This chapter describes configuring queue distribution based on type of service such as Precedence or DSCP on Layer 3 interface. Prior to this feature support, only one type of configuration was possible either precedence or DSCP.

Using the most significant three bits of the DSCP such as Class Selector bits which provides backward compatibility with ip precedence, user can set Precedence. For example when user configure Precedence as 101 in CLI, convert this value to DSCPs(101000 ~ 101111), then set the DSCP.

In the configuration section, new precedence profiles are introduced as qos map-profile based on the existing DSCP profiles.

The configuration procedures given below are similar to DSCP, however, both configurations are supported based on requirements.

Service based Queue configuration

There are 2 Qos-map Precedence profiles used in the configuration procedure.

Precedence-to-queue:

This is an ingress profile similar to dscp-to-queue. This profile will map precedence value 0-7 to queue 0-7

Topology



Figure 7-8: Precedence-to-queue topology

#configure terminal	Enter configure mode
(config)#enable qos	Enable Qos
(config)#exit	Exit configure mode
(config)# qos profile precedence-to-queue Prece1_que1	Configure qos-map profile precedence-to-queue with
Profile name as Prece1_que1	
(config-ingress-prec-map)# precedence 1 queue 2	Configure mapping of prece 1 to queue 2, so that traffic with precedence 1 should take queue as q2
(config)#exit	Exit configure mode
(config)# interface xe1	Configure ingress interface xe1

<pre>(config-if)#qos map-profile precedence-to-queue Prec1_que1</pre>	Map the profile Prec1_que1 to interface xe1 so that ingress traffic hitting the xe1 interface with prece as 1 should take queue q2
<pre>(config)#commit</pre>	Commit the configuration
<pre>(config)#end</pre>	

Validation

```
#show run int xe1
!  
interface xe1
  qos map-profile precedence-to-queue Prec1_que1
!
```

```
#show qos-profile type precedence-to-queue
profile name: Prec1_que1
profile type: precedence-to-queue
profile attached to 1 instances
configured mapping:
precedence 1 queue 2
Detailed mapping:
```

```
-----+-----  
INPUT | OUTPUT  
-----+-----  
PREC | Queue | Out PREC  
-----+-----  
0     | 0     | 0  
1     | 1     | 2  
2     | 2     | 0  
3     | 3     | 0  
4     | 4     | 0  
5     | 5     | 0  
6     | 6     | 0  
7     | 7     | 0
```

```
R1#show run qos
qos enable
!  
qos profile precedence-to-queue Prec1_que1
  precedence 1 queue 2
!  
interface xe1
  qos map-profile precedence-to-queue Prec1_que1
```

Queue-to-precedence:

This is egress profile similar to queue-to-dscp. This qos-map profile maps default or corresponding queue to new precedence value that enables the user to see queue corresponding to new precedence mentioned in this profile on the next node egress interface.

Topology

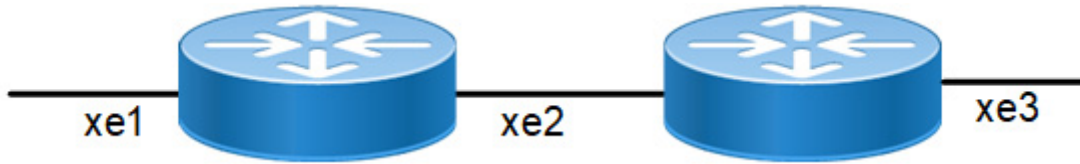

#configure terminal	Enter configure mode
(config)#enable qos	Enable Qos
(config)#exit	Exit configure mode
(config)# qos profile queue-to-precedence queue_prece1	Configure qos-map profile queue-to-precedence with Profile name as queue_prece1
(config-ingress-prec-map)# queue 2 precedence 5	Configure mapping of queue 2 to precedence 5, so that traffic with precedence 1 should take queue as q2
(config)#exit	Exit configure mode
(config)# interface xe2	Configure egress interface xe2 of 1st node
(config-if)#qos map-profile queue-to-precedence queue_prece1	Map the profile queue_prece1 to interface xe2 so that egress traffic from xe2 can be remarked with new precedence value 5 and on next node can verify this on egress interface xe3
(config)#commit	Commit the configuration
(config)#end	

Validation

```
#show run int ce50
!
interface ce50
  qos map-profile queue-to-precedence queue_prece1
!
#
```

```
R1#show run qos
qos enable
qos statistics
qos remark dscp
!
!
qos profile queue-to-precedence queue_prece1
```

```
queue 2 precedence 5
!  
!  
!  
interface ce50  
  qos map-profile queue-to-precedence queuee_prece1  
!  
#
```

```
#show qos-profile queuee_prece1  
profile name: queuee_prece1  
profile type: queue-to-precedence  
profile attached to 1 instances  
configured mapping:  
  queue 2 precedence 5
```

Detailed mapping:

```
-----+-----  
  INPUT | OUTPUT  
-----+-----  
  Queue | PREC  
-----+-----  
  0      | 0  
  1      | 1  
  2      | 5  
  3      | 3  
  4      | 4  
  5      | 5  
  6      | 6  
  7      | 7
```

CHAPTER 8 Weights for Queues Configuration

This chapter contains a complete sample of configuring WRR weights for queues.

Topology



Figure 8-9: Simple configuration of QoS

Configuring WRR Weights for Queues

Do the following to configure WRR weights for queues.

#configure terminal	Enter configure mode.
(config)#qos enable	Enable QoS globally.
(config)#qos statistics	Enable QoS statistics.
(config)#class-map cmap1	Enter class-map mode
(config-cmap-qos)#match cos 2	Configure match criteria as cos 2
(config-cmap-qos)#exit	Exit out of class-map mode
(config)#class-map cmap2	Enter class-map mode
(config-cmap-qos)#match cos 3	Configure match criteria as cos 3
(config-cmap-qos)#exit	Exit out of class-map mode
(config)#policy-map pmap1	Enter policy-map mode.
(config-pmap-qos)#class cmap1	Assign class cmap1.
(config-pmap-c-qos)#set qos-group 1	Remark matched traffic to qos-group 1
(config-pmap-c-qos)#exit	Exit out of pmap-c mode
(config-pmap-qos)#exit	Exit pmap mode.
(config)#policy-map pmap1	Enter policy-map mode.
(config-pmap-qos)#class cmap2	Assign class cmap2.
(config-pmap-c-qos)#set qos-group 2	Remark matched traffic to qos-group 2
(config-pmap-c-qos)#exit	Exit out of pmap-c mode
(config-pmap-qos)#exit	Exit pmap mode.
(config)#class-map type queuing cq1	Configure class-map of type queuing with name cq1, and enter into class-map mode
(config-cmap-que)#match qos-group 1	Configure match criteria as qos-group 1
(config-cmap-que)#exit	Exit out of class-map mode.
(config)#class-map type queuing cq2	Configure class-map of type queuing with name cq2, and enter into class-map mode.
(config-cmap-que)#match qos-group 2	Configure match criteria as qos-group 2.
(config-cmap-que)#exit	Exit out of class-map mode.

Weights for Queues Configuration

<code>(config)#policy-map type queuing pq1</code>	Configure policy-map of type queuing with name pq1, and enter into policy-map mode.
<code>(config-pmap-que)#class cq1</code>	Attach class cq1 to Policy-map pq1.
<code>(config-pmap-c-que)#wrr-queue weight 2</code>	Configure WRR Weight of 2.
<code>(config-pmap-c-que)#exit</code>	Exit from pmap-c mode.
<code>(config-pmap-que)#class cq2</code>	Assign class (queue) cq2 to pq1.
<code>(config-pmap-c-que)#wrr-queue weight 4</code>	Configure WRR weight of 4.
<code>(config-pmap-c-que)#exit</code>	Exit from pmap-c mode.
<code>(config-pmap-que)#exit</code>	Exit from pmap mode.
<code>(config)#interface xe2</code>	Enter into interface xe2.
<code>(config-if)#service-policy type queuing output pq1</code>	Assign service policy pq1 of type queueing on out direction.
<code>(config-if)#exit</code>	Exit interface mode
<code>(config)#exit</code>	Exit configure mode.
<code>(config)#bridge 1 protocol rstp vlan-bridge</code>	Specify VLAN for bridge 1.
<code>(config)#vlan database</code>	Enter the VLAN configuration mode.
<code>(config-vlan)#vlan 2-3 bridge 1 state enable</code>	Enable VLAN (2-3) on bridge 1. Specifying the enable state.
<code>(config-vlan)#exit</code>	Exit the VLAN configuration mode.
<code>(config)#interface vlan1.2</code>	Enter interface mode.
<code>(config-if)# ip address 10.1.1.1/24</code>	Configure the IP address.
<code>(config-if)#exit</code>	Exit the interface mode.
<code>(config)#interface xe2</code>	Enter interface mode.
<code>(config-if)#switchport</code>	Configure xe2 as a Layer 2 port.
<code>(config-if)#bridge-group 1</code>	Associate the interface with bridge group 1.
<code>(config-if)#switchport mode trunk</code>	Configure port as a trunk.
<code>(config-if)#switchport trunk allowed vlan all</code>	Allow all the VLANs on the xe3 interface.
<code>(config-if)#exit</code>	Exit the interface mode.
<code>(config)#interface xe3</code>	Enter interface mode.
<code>(config-if)#switchport</code>	Configure xe3 as a Layer 2 port.
<code>(config-if)#bridge-group 1</code>	Associate the interface with bridge group 1.
<code>(config-if)#switchport mode trunk</code>	Configure port as a trunk.
<code>(config-if)#switchport trunk allowed vlan all</code>	Allow all the VLANs on the xe3 interface.
<code>(config-if)# service-policy type qos input pmap1</code>	Assign service-policy to interface on in-direction
<code>(config-if)#exit</code>	Exit the interface mode.

Validation

Enter the commands listed in the sections below to confirm the configurations.

```
#show running-config qos
qos enable
!
qos statistics
```

```
!  
class-map cmap1  
  match cos 2  
!  
class-map cmap2  
  match cos 3  
!  
class-map type queuing match-any cq1  
  match qos-group 1  
!  
class-map type queuing match-any cq2  
  match qos-group 2  
!  
policy-map pmap1  
  class cmap1  
    set qos-group 1  
    exit  
  class cmap2  
    set qos-group 2  
    exit  
!  
!  
policy-map type queuing pq1  
  class type queuing cq1  
    wrr-queue weight 2  
    exit  
  class type queuing cq2  
    wrr-queue weight 4  
    exit  
!  
!  
interface xe2  
  service-policy type queuing output pq1  
!  
interface xe3  
  service-policy type qos input pmap1  
!
```

```
#show policy-map
```

```
Type qos policy-maps  
=====
```

```
policy-map pmap1  
  class cmap1  
    set qos-group 1  
    exit  
  class cmap2  
    set qos-group 2
```

```
exit
```

```
Type queuing policy-maps
```

```
=====
```

```
policy-map type queuing default default-out-policy
```

```
class type queuing default q0
```

```
priority level 1
```

```
exit
```

```
class type queuing default q1
```

```
priority level 1
```

```
exit
```

```
class type queuing default q2
```

```
priority level 1
```

```
exit
```

```
class type queuing default q3
```

```
priority level 1
```

```
exit
```

```
class type queuing default q4
```

```
priority level 1
```

```
exit
```

```
class type queuing default q5
```

```
priority level 1
```

```
exit
```

```
class type queuing default q6
```

```
priority level 1
```

```
exit
```

```
class type queuing default q7
```

```
priority level 1
```

```
exit
```

```
policy-map type queuing pq1
```

```
class type queuing cq1
```

```
wrr-queue weight 2
```

```
exit
```

```
class type queuing cq2
```

```
wrr-queue weight 4
```

```
exit
```

```
#show class-map
```

```
Type qos class-maps
```

```
=====
```

```
class-map type qos match-any class-default
```

```
class-map cmap1
```

```
match cos 2
```

```
class-map cmap2
  match cos 3
```

```
Type queuing class-maps
```

```
=====
```

```
class-map type queuing match-any cq1
  match qos-group 1
```

```
class-map type queuing match-any cq2
  match qos-group 2
```

```
class-map match-any q0
```

```
class-map match-any q1
```

```
class-map match-any q2
```

```
class-map match-any q3
```

```
class-map match-any q4
```

```
class-map match-any q5
```

```
class-map match-any q6
```

```
class-map match-any q7
```

```
Type Vlan-Queuing class-maps
```

```
=====
```

```
#show policy-map interface xe2
Interface xe2
Global statistics status : enabled
```

```
Service-policy (queuing) output: pq1
```

```
-----
```

```
Class-map (queuing): cq1
  match qos-group 1
  wrr-queue weight 2
    output      : 0 packets, 0 bytes
    dropped     : 0 packets, 0 bytes
```

```
Class-map (queuing): cq2
  match qos-group 2
  wrr-queue weight 4
    output      : 0 packets, 0 bytes
    dropped     : 0 packets, 0 bytes
```

Weights for Queues Configuration

Service-policy (queuing) output: default-out-policy

Class-map (queuing): q0
 priority level 1
 output : 0 packets, 0 bytes
 dropped : 0 packets, 0 bytes

Class-map (queuing): q1
 priority level 1
 output : 0 packets, 0 bytes
 dropped : 0 packets, 0 bytes

Class-map (queuing): q2
 priority level 1
 output : 0 packets, 0 bytes
 dropped : 0 packets, 0 bytes

Class-map (queuing): q3
 priority level 1
 output : 0 packets, 0 bytes
 dropped : 0 packets, 0 bytes

Class-map (queuing): q4
 priority level 1
 output : 0 packets, 0 bytes
 dropped : 0 packets, 0 bytes

Class-map (queuing): q5
 priority level 1
 output : 0 packets, 0 bytes
 dropped : 0 packets, 0 bytes

Class-map (queuing): q6
 priority level 1
 output : 0 packets, 0 bytes
 dropped : 0 packets, 0 bytes

Class-map (queuing): q7
 priority level 1
 output : 0 packets, 0 bytes
 dropped : 0 packets, 0 bytes

Class-map (queuing): mc-q0
 output : 0 packets, 0 bytes
 dropped : 0 packets, 0 bytes

Class-map (queuing): mc-q1
 output : 0 packets, 0 bytes
 dropped : 0 packets, 0 bytes

```
Class-map (queuing): mc-q2
  output      : 0 packets, 0 bytes
  dropped     : 0 packets, 0 bytes

Class-map (queuing): mc-q3
  output      : 0 packets, 0 bytes
  dropped     : 0 packets, 0 bytes

Class-map (queuing): mc-q4
  output      : 0 packets, 0 bytes
  dropped     : 0 packets, 0 bytes

Class-map (queuing): mc-q5
  output      : 0 packets, 0 bytes
  dropped     : 0 packets, 0 bytes

Class-map (queuing): mc-q6
  output      : 0 packets, 0 bytes
  dropped     : 0 packets, 0 bytes

Class-map (queuing): mc-q7
  output      : 0 packets, 0 bytes
  dropped     : 0 packets, 0 bytes

Wred Drop Statistics :
-----
green  : 0 packets
yellow : 0 packets
red    : 0 packets

#show policy-map interface xe3

Interface xe3
Global statistics status : enabled

Service-policy (qos) input      : pmap1
-----
Class-map (qos): cmap1 (match all)
  match cos 2
  set qos-group 1
    matched      : 209681694 packets, 15097081968 bytes
    transmitted  : 209681694 packets, 15097081968 bytes

Class-map (qos): cmap2 (match all)
  match cos 3
  set qos-group 2
    matched      : 0 packets, 0 bytes
    transmitted  : 0 packets, 0 bytes
```

Weights for Queues Configuration

Service-policy (queuing) output: default-out-policy

Class-map (queuing): q0

priority level 1
output : 0 packets, 0 bytes
dropped : 0 packets, 0 bytes

Class-map (queuing): q1

priority level 1
output : 11789 packets, 754820 bytes
dropped : 0 packets, 0 bytes

Class-map (queuing): q2

priority level 1
output : 0 packets, 0 bytes
dropped : 0 packets, 0 bytes

Class-map (queuing): q3

priority level 1
output : 0 packets, 0 bytes
dropped : 0 packets, 0 bytes

Class-map (queuing): q4

priority level 1
output : 0 packets, 0 bytes
dropped : 0 packets, 0 bytes

Class-map (queuing): q5

priority level 1
output : 0 packets, 0 bytes
dropped : 0 packets, 0 bytes

Class-map (queuing): q6

priority level 1
output : 0 packets, 0 bytes
dropped : 0 packets, 0 bytes

Class-map (queuing): q7

priority level 1
output : 1460 packets, 93914 bytes
dropped : 0 packets, 0 bytes

Class-map (queuing): mc-q0

output : 39311112 packets, 2830400048 bytes
dropped : 0 packets, 0 bytes

Class-map (queuing): mc-q1

output : 0 packets, 0 bytes
dropped : 0 packets, 0 bytes

Class-map (queuing): mc-q2
output : 78930334 packets, 5051541376 bytes
dropped : 0 packets, 0 bytes

Class-map (queuing): mc-q3
output : 0 packets, 0 bytes
dropped : 0 packets, 0 bytes

Class-map (queuing): mc-q4
output : 0 packets, 0 bytes
dropped : 0 packets, 0 bytes

Class-map (queuing): mc-q5
output : 0 packets, 0 bytes
dropped : 0 packets, 0 bytes

Class-map (queuing): mc-q6
output : 0 packets, 0 bytes
dropped : 0 packets, 0 bytes

Class-map (queuing): mc-q7
output : 21 packets, 1428 bytes
dropped : 0 packets, 0 bytes

Wred Drop Statistics :

green : 0 packets
yellow : 0 packets
red : 0 packets

CHAPTER 9 Marking/Remarking Configuration

This chapter contains a complete sample of configuring Marking/Remarking.

Topology

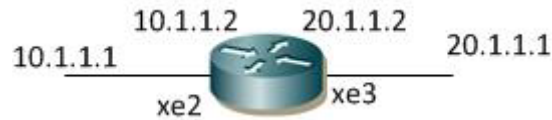

Figure 9-10: Simple configuration of Marking/Remarking

L2 Interface

The following steps describe how to configure Marking/Remarking.

#configure terminal	Enter configure mode.
(config)#bridge 1 protocol rstp vlan-bridge	Configure bridge 1 as RSTP-VLAN aware.
(config)#interface xe2	Enter interface mode.
(config-if)#switchport	Configure xe2 as a Layer 2 port.
(config-if)#bridge-group 1	Associate bridge to an interface.
(config-if)#switchport mode trunk	Configure port as a trunk.
(config-if)#switchport trunk allowed vlan all	Allow all the VLANs on the xe2 interface.
(config-if)#exit	Exit the xe2 interface mode.
(config)#qos enable	Enable QoS globally.
(config)#qos statistics	Enable QoS statistics.
(config)#class-map type qos cmap1	Enter Class-map mode
(config-cmap-qos)#match cos 2	Configure match criteria as CoS with Value 2
(config-cmap-qos)#exit	Exit Class-map mode
(config)#policy-map type qos pmap1	Enter policy-map mode
(config-pmap-qos)#class type qos cmap1	Assign Class cmap1 to Policy-map pmap1
(config-pmap-c-qos)#set cos 5	Remark cos from cos 2 to cos 5
(config-pmap-c-qos)#exit	Exit out of policy-class-map mode
(config-pmap-qos)#exit	Exit out of Policy-map mode
(config)#interface xe2	Enter xe2 interface
(config-if)#service-policy type qos input pmap1	Assign service-policy to interface on in-direction
(config-if)#exit	Exit the xe2 interface mode.

Marking/Remarking Configuration

<code>(config)#interface xe3</code>	Enter interface mode.
<code>(config-if)#switchport</code>	Configure xe3 as a Layer 2 port.
<code>(config-if)#bridge-group 1</code>	Associate bridge to an interface.
<code>(config-if)#switchport mode trunk</code>	Configure port as a trunk.
<code>(config-if)#switchport trunk allowed vlan all</code>	Allow all the VLANs on the xe3 interface.
<code>(config-if)#exit</code>	Exit the xe3 interface mode.
<code>(config)#class-map type qos cmap2</code>	Enter Class-map mode
<code>(config-cmap-qos)#match protocol arp</code>	Configure match criteria as protocol with arp
<code>(config-cmap-qos)#exit</code>	Exit Class-map mode
<code>(config)#policy-map type qos pmap2</code>	Enter policy-map mode
<code>(config-pmap-qos)#class type qos cmap2</code>	Assign Class cmap2 to Policy-map pmap2
<code>(config-pmap-c-qos)#set cos 6</code>	Remark all frame with ethertype as arp to cos 6
<code>(config-pmap-c-qos)#exit</code>	Exit out of policy-class-map mode
<code>(config-pmap-qos)#exit</code>	Exit out of Policy-map mode
<code>(config)#interface xe3</code>	Enter xe3 interface
<code>(config-if)#service-policy type qos input pmap2</code>	Assign service-policy to interface on in-direction
<code>(config-if)#exit</code>	Exit out of interface mode
<code>(config)#bridge 1 protocol rstp vlan-bridge</code>	Specify VLAN for bridge 1.
<code>(config)#vlan database</code>	Enter the VLAN configuration mode.
<code>(config-vlan)#vlan 2-3 bridge 1 state enable</code>	Enable VLAN (2-3) on bridge 1. Specifying the enable state.
<code>(config-vlan)#exit</code>	Exit the VLAN configuration mode.
<code>(config)#interface vlan1.2</code>	Enter interface mode.
<code>(config-if)# ip address 10.1.1.2/24</code>	Configure the IP address.
<code>(config-if)#exit</code>	Exit the interface mode.
<code>(config)#interface vlan1.3</code>	Enter interface mode.
<code>(config-if)# ip address 20.1.1.1/24</code>	Configure the IP address.
<code>(config-if)#exit</code>	Exit the interface mode.

Validation

Enter the commands listed in the sections below to confirm the configurations.

```
#show running-config qos
qos enable
!
qos statistics
!
class-map type qos cmap1
  match cos 2
!
class-map type qos cmap2
  match protocol arp
```

```
!  
policy-map type qos pmap1  
  class type qos cmap1  
    set cos 5  
  exit  
!  
policy-map type qos pmap2  
  class type qos cmap2  
    set cos 6  
  exit  
!  
!  
!  
interface xe2  
  service-policy type qos input pmap1  
!  
interface xe3  
  service-policy type qos input pmap2  
!  
  
#show class-map cmap1  
  
Type qos class-maps  
=====
```

```
      class-map type qos cmap1  
        match cos 2
```

```
#show policy-map  
  
Type qos policy-maps  
=====
```

```
policy-map type qos pmap1  
  class type qos cmap1  
    set cos 5  
  exit
```

```
policy-map type qos pmap2  
  class type qos cmap2  
    set cos 6  
  exit
```

```
Type queuing policy-maps  
=====
```

```
policy-map type queuing default default-out-policy  
  class type queuing default q0  
    priority  
  exit  
  class type queuing default q1  
    priority  
  exit  
  class type queuing default q2  
    priority
```

```
exit
class type queuing default q3
priority
exit
class type queuing default q4
priority
exit
class type queuing default q5
priority
exit
class type queuing default q6
priority
exit
class type queuing default q7
priority
exit

#show policy-map interface xe2

Interface xe2
Global statistics status : enabled

Class-map (qos): cmap1 (match all)
match cos 2
set cos 5
    matched      : 8 packets, 680 bytes
    transmitted  : 8 packets, 680 bytes

Service-policy (queuing) output: default-out-policy
-----
Class-map (queuing): q0
priority
    output       : 0 packets, 0 bytes
    dropped      : 0 packets, 0 bytes

Class-map (queuing): q1
priority
    output       : 12 packets, 1416 bytes
    dropped      : 0 packets, 0 bytes

Class-map (queuing): q2
priority
    output       : 0 packets, 0 bytes
    dropped      : 0 packets, 0 bytes

Class-map (queuing): q3
priority
    output       : 0 packets, 0 bytes
    dropped      : 0 packets, 0 bytes

Class-map (queuing): q4
priority
    output       : 0 packets, 0 bytes
    dropped      : 0 packets, 0 bytes

Class-map (queuing): q5
```

```
priority
  output      : 0 packets, 0 bytes
  dropped     : 0 packets, 0 bytes

Class-map (queuing): q6
  priority
    output      : 0 packets, 0 bytes
    dropped     : 0 packets, 0 bytes

Class-map (queuing): q7
  priority
    output      : 589 packets, 37876 bytes
    dropped     : 0 packets, 0 bytes

Class-map (queuing): mc-q0
  output      : 0 packets, 0 bytes
  dropped     : 0 packets, 0 bytes

Class-map (queuing): mc-q1
  output      : 0 packets, 0 bytes
  dropped     : 0 packets, 0 bytes

Class-map (queuing): mc-q2
  output      : 0 packets, 0 bytes
  dropped     : 0 packets, 0 bytes

Class-map (queuing): mc-q3
  output      : 0 packets, 0 bytes
  dropped     : 0 packets, 0 bytes

Class-map (queuing): mc-q4
  output      : 0 packets, 0 bytes
  dropped     : 0 packets, 0 bytes

Class-map (queuing): mc-q5
  output      : 0 packets, 0 bytes
  dropped     : 0 packets, 0 bytes

Class-map (queuing): mc-q6
  output      : 7 packets, 448 bytes
  dropped     : 0 packets, 0 bytes

Class-map (queuing): mc-q7
  output      : 12 packets, 852 bytes
  dropped     : 0 packets, 0 bytes

Wred Drop Statistics :
-----
green  : 0 packets
yellow : 0 packets
red    : 0 packets

OcNOS#show policy-map interface xe3

Interface xe3
Type QoS statistics status : enabled
```

```
Class-map (qos): cmap2 (match all)
  match protocol arp
  set cos 6

      matched      : 7 packets, 448 bytes
      transmitted  : 7 packets, 448 bytes

Service-policy (queuing) output: default-out-policy
-----
Class-map (queuing): q0
  priority
    output      : 0 packets, 0 bytes
    dropped     : 0 packets, 0 bytes

Class-map (queuing): q1
  priority
    output      : 0 packets, 0 bytes
    dropped     : 0 packets, 0 bytes

Class-map (queuing): q2
  priority
    output      : 0 packets, 0 bytes
    dropped     : 0 packets, 0 bytes

Class-map (queuing): q3
  priority
    output      : 0 packets, 0 bytes
    dropped     : 0 packets, 0 bytes

Class-map (queuing): q4
  priority
    output      : 0 packets, 0 bytes
    dropped     : 0 packets, 0 bytes

Class-map (queuing): q5
  priority
    output      : 0 packets, 0 bytes
    dropped     : 0 packets, 0 bytes

Class-map (queuing): q6
  priority
    output      : 0 packets, 0 bytes
    dropped     : 0 packets, 0 bytes

Class-map (queuing): q7
  priority
    output      : 699 packets, 59550 bytes
    dropped     : 0 packets, 0 bytes

Class-map (queuing): mc-q0
  output      : 0 packets, 0 bytes
  dropped     : 0 packets, 0 bytes

Class-map (queuing): mc-q1
  output      : 0 packets, 0 bytes
```

```

        dropped      : 0 packets, 0 bytes

Class-map (queuing): mc-q2
  output      : 0 packets, 0 bytes
  dropped     : 0 packets, 0 bytes

Class-map (queuing): mc-q3
  output      : 0 packets, 0 bytes
  dropped     : 0 packets, 0 bytes

Class-map (queuing): mc-q4
  output      : 0 packets, 0 bytes
  dropped     : 0 packets, 0 bytes

Class-map (queuing): mc-q5
  output      : 1 packets, 64 bytes
  dropped     : 0 packets, 0 bytes

Class-map (queuing): mc-q6
  output      : 0 packets, 0 bytes
  dropped     : 0 packets, 0 bytes

Class-map (queuing): mc-q7
  output      : 2 packets, 136 bytes
  dropped     : 0 packets, 0 bytes

Wred Drop Statistics :
-----
green  : 0 packets
yellow : 0 packets
red    : 0 packets

```

L3 Interface

#configure terminal	Enter configure mode.
(config)#interface xe3	Enter interface mode.
(config-if)#ip address 10.1.1.1/24	Assign IP Address on interface to 10.1.1.2 with mask 255.255.255.0
(config-if)#exit	Exit out of interface mode
(config)#qos enable	Enable QoS globally.
(config)#qos statistics	Enable QoS statistics.
(config)#class-map type qos cmap3	Configure class-map of type qos with name cmap3 and enter into Class-map mode
(config-cmap-qos)#match dscp 10	Configure match criteria as dscp with a value of 10.
(config-cmap-qos)#exit	Exit Class-map mode
(config)#policy-map type qos pmap3	Enter policy-map mode

Marking/Remarking Configuration

<code>(config-pmap-qos)#class type qos cmap3</code>	Assign Class cmap3 to Policy-map pmap3
<code>(config-pmap-c-qos)#set dscp ef</code>	Remark frames with dscp value 10 to dscp 46
<code>(config-pmap-c-qos)#exit</code>	Exit out of policy-class-map mode
<code>(config-pmap-qos)#exit</code>	Exit out of Policy-map mode
<code>(config)#interface xe3</code>	Enter xe3 interface
<code>(config-if)#service-policy type qos input pmap3</code>	Assign service-policy pmap3 to interface xe3 on in-direction
<code>(config-if)#exit</code>	Exit out of interface mode
<code>(config)#ip access-list 101</code>	Configure access-list 101 with action as permit for tcp traffic with destination port as ftp port
<code>(config-ip-acl)#permit tcp any any eq ftp</code>	Permit for tcp traffic with destination port as ftp port.
<code>(config-ip-acl)#exit</code>	Exit access list mode
<code>(config)#class-map type qos match-any cmap4</code>	Enter Class-map mode
<code>(config-cmap-qos)#match access-group 101</code>	Configure access-group 101 as match criteria
<code>(config-cmap-qos)#exit</code>	Exit class-map mode
<code>(config)#policy-map type qos pmap4</code>	Enter policy map mode
<code>(config-pmap-qos)#class cmap4</code>	Assign Class cmap4 to Policy-map pmap4
<code>(config-pmap-c-qos)#set precedence 7</code>	Remark frames matching access-group 101 to precedence 7
<code>(config-pmap-c-qos)#exit</code>	Exit out of policy-class-map mode
<code>(config-pmap-qos)#exit</code>	Exit out of Policy-map mode
<code>(config)#interface xe2</code>	Enter interface mode.
<code>(config-if)#ip address 20.1.1.1/24</code>	Assign IP Address on interface to 20.1.1.1 with mask 255.255.255.0
<code>(config-if)#service-policy type qos input pmap4</code>	Assign service-policy to interface on in-direction

Validation

Enter the commands listed in the sections below to confirm the configurations.

```
#show running-config qos
qos enable
!
qos statistics
!
class-map type qos cmap3
  match dscp af11
```

```
!  
class-map type qos match-any cmap4  
  match access-group 101  
!  
policy-map type qos pmap3  
  class type qos cmap3  
    set dscp ef  
  exit  
policy-map type qos pmap4  
  class type qos cmap4  
    set precedence network  
  exit  
!  
interface xe2  
  service-policy type qos input pmap4  
!  
interface xe3  
  service-policy type qos input pmap3  
  
#show class-map type qos  
  
Type qos class-maps  
=====
```

```
  class-map type qos match-any class-default  
  
  class-map type qos cmap3  
    match dscp af11  
  
  class-map type qos match-any cmap4  
    match access-group 101
```

```
#show policy-map  
  
Type qos policy-maps  
=====
```

```
policy-map type qos pmap3  
  class type qos cmap3  
    set dscp ef  
  
policy-map type qos pmap4  
  class type qos cmap4  
    set precedence network
```

```
Type queuing policy-maps  
=====
```

```
policy-map type queuing default default-out-policy
  class type queuing default q0
    priority
  class type queuing default q1
    priority
  class type queuing default q2
    priority
  class type queuing default q3
    priority
  class type queuing default q4
    priority
  class type queuing default q5
    priority
  class type queuing default q6
    priority
  class type queuing default q7
  priority
```

```
#show policy-map interface xe2
```

```
Interface xe2
```

```
Type Qos statistics status : enabled
```

```
-----
```

```
Class-map (qos): cmap4 (match any)
```

```
match access-group 101
```

```
set precedence 7
```

```
    matched      : 375594046 packets, 25540397168 bytes
```

```
Service-policy (queuing) output: default-out-policy
```

```
-----
```

```
Class-map (queuing): q0
```

```
priority
```

```
    output       : 0 packets, 0 bytes
```

```
    dropped      : 0 packets, 0 bytes
```

```
Class-map (queuing): q1
```

```
priority
```

```
    output       : 0 packets, 0 bytes
```

```
    dropped      : 0 packets, 0 bytes
```

```
Class-map (queuing): q2
```

```
priority
```

```
    output       : 0 packets, 0 bytes
```

```
    dropped      : 0 packets, 0 bytes
```

```
Class-map (queuing): q3
priority
  output      : 0 packets, 0 bytes
  dropped     : 0 packets, 0 bytes

Class-map (queuing): q4
priority
  output      : 0 packets, 0 bytes
  dropped     : 0 packets, 0 bytes

Class-map (queuing): q5
priority
  output      : 391282612 packets, 25042086656 bytes
  dropped     : 0 packets, 0 bytes

Class-map (queuing): q6
priority
  output      : 0 packets, 0 bytes
  dropped     : 0 packets, 0 bytes

Class-map (queuing): q7
priority
  output      : 4 packets, 256 bytes
  dropped     : 0 packets, 0 bytes

Class-map (queuing): mc-q0
  output      : 0 packets, 0 bytes
  dropped     : 0 packets, 0 bytes

Class-map (queuing): mc-q1
  output      : 0 packets, 0 bytes
  dropped     : 0 packets, 0 bytes

Class-map (queuing): mc-q2
  output      : 0 packets, 0 bytes
  dropped     : 0 packets, 0 bytes

Class-map (queuing): mc-q3
  output      : 0 packets, 0 bytes
  dropped     : 0 packets, 0 bytes
```

Marking/Remarking Configuration

```
Class-map (queuing): mc-q4
  output      : 0 packets, 0 bytes
  dropped     : 0 packets, 0 bytes
```

```
Class-map (queuing): mc-q5
  output      : 0 packets, 0 bytes
  dropped     : 0 packets, 0 bytes
```

```
Class-map (queuing): mc-q6
  output      : 0 packets, 0 bytes
  dropped     : 0 packets, 0 bytes
```

```
Class-map (queuing): mc-q7
  output      : 0 packets, 0 bytes
  dropped     : 0 packets, 0 bytes
```

```
Wred Drop Statistics :
```

```
-----
green  : 0 packets
yellow : 0 packets
red    : 0 packets
```

```
#show policy-map interface xe3
```

```
Interface xe3
Global statistics status : enabled
```

```
-----
Class-map (qos): cmap3 (match all)
match dscp af11
set dscp 46
  matched      : 401497149 packets, 25695819008 bytes
```

```
Service-policy (queuing) output: default-out-policy
```

```
-----
Class-map (queuing): q0
priority level 1
  output      : 0 packets, 0 bytes
  dropped     : 0 packets, 0 bytes
```

```
Class-map (queuing): q1
priority
  output      : 0 packets, 0 bytes
  dropped     : 0 packets, 0 bytes
```

Class-map (queuing): q2
priority
 output : 0 packets, 0 bytes
 dropped : 0 packets, 0 bytes

Class-map (queuing): q3
priority
 output : 0 packets, 0 bytes
 dropped : 0 packets, 0 bytes

Class-map (queuing): q4
priority
 output : 0 packets, 0 bytes
 dropped : 0 packets, 0 bytes

Class-map (queuing): q5
priority
 output : 0 packets, 0 bytes
 dropped : 0 packets, 0 bytes

Class-map (queuing): q6
priority
 output : 0 packets, 0 bytes
 dropped : 0 packets, 0 bytes

Class-map (queuing): q7
priority
 output : 382211720 packets, 25990396484 bytes
 dropped : 0 packets, 0 bytes

Class-map (queuing): mc-q0
 output : 0 packets, 0 bytes
 dropped : 0 packets, 0 bytes

Class-map (queuing): mc-q1
 output : 0 packets, 0 bytes
 dropped : 0 packets, 0 bytes

Class-map (queuing): mc-q2
 output : 0 packets, 0 bytes

Marking/Remarking Configuration

dropped : 0 packets, 0 bytes

Class-map (queuing): mc-q3
output : 0 packets, 0 bytes
dropped : 0 packets, 0 bytes

Class-map (queuing): mc-q4
output : 0 packets, 0 bytes
dropped : 0 packets, 0 bytes

Class-map (queuing): mc-q5
output : 0 packets, 0 bytes
dropped : 0 packets, 0 bytes

Class-map (queuing): mc-q6
output : 0 packets, 0 bytes
dropped : 0 packets, 0 bytes

Class-map (queuing): mc-q7
output : 0 packets, 0 bytes
dropped : 0 packets, 0 bytes

Wred Drop Statistics :

green : 0 packets
yellow : 0 packets
red : 0 packets

CHAPTER 10 Policing Configuration

Topology

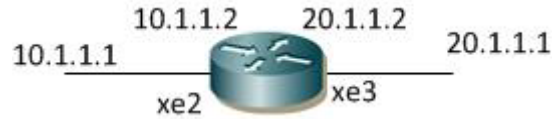

Figure 10-11: Simple configuration of Policing

L2 Interface

Do the following to configure policing on an L2 interface.

#configure terminal	Enter configure mode.
(config)#bridge 1 protocol mstp	Configure bridge 1 as mstp aware.
(config)#interface xe2	Enter interface mode.
(config-if)#switchport	Configure xe2 as a Layer 2 port.
(config-if)#bridge-group 1	Associate bridge to an interface.
(config-if)#switchport mode trunk	Configure port as a trunk.
(config-if)#switchport trunk allowed vlan all	Allow all the VLANs on the xe2 interface.
(config-if)#exit	Exit the xe2 interface mode.
(config)#qos enable	Enable QoS globally.
(config)#qos statistics	Enable QoS statistics.
(config)#class-map type qos 1234	Enter Class-map mode
(config-cmap-qos)#match cos 3	Configure match criteria as CoS with Value 3
(config-cmap-qos)#exit	Exit Class-map mode
(config)#policy-map type qos 1234	Enter policy-map mode
(config-pmap-qos)#class type qos 1234	Assign Class 1234 to Policy-map 1234
(config-pmap-c-qos)# police cir 2 mbps pir 3 mbps bc 2 mbytes be 2 mbytes conform transmit exceed set-cos-transmit 1 violate drop	Police access-list 102 frames @ Committed information rate 2 mbps, committed bust 2 mbyte, peak information rate 3 mbps, peak burst 2 mbytes when traffic is > CIR and <= PIR then Set the class of service (CoS) field to 1, if traffic violate the action then drop the frames.
(config-pmap-c-qos)#exit	Exit out of policy-class-map mode
(config-pmap-qos)#exit	Exit out of Policy-map mode
(config)#interface xe2	Enter xe2 interface
(config-if)#service-policy type qos input 1234	Assign service-policy to interface on in-direction
(config)#interface xe3	Enter interface mode.
(config-if)#switchport	Configure xe3 as a Layer 2 port.
(config-if)#bridge-group 1	Associate bridge to an interface.

Policing Configuration

(config-if)#switchport mode trunk	Configure port as a trunk.
(config-if)#switchport trunk allowed vlan all	Allow all the VLANs on the xe3 interface.
(config-if)#exit	Exit the xe3 interface mode.
(config)#mac access-list 102	Configure mac access-list with action
(config-mac-acl)#permit host 0000.0101.1010 host 0000.0202.2020	Permit when frames matches Source mac address 00:00:01:01:10:10 and destination mac address 00:00:02:02:20:20
(config-mac-acl)#exit	Exit mac access-list mode
(config)#class-map type qos match-any 2345	Enter Class-map mode
(cmap-qos-match-any-mode)#match access-group 102	Configure match criteria as access-group 102
(cmap-qos-match-any-mode)#exit	Exit Class-map mode
(config)#policy-map type qos 2345	Enter policy-map mode
(config-pmap-qos)#class type qos 2345	Assign Class 2345 to Policy-map 2345
(config-pmap-c-qos)# police cir 2 mbps pir 3 mbps bc 2 mbytes be 2 mbytes conform transmit exceed set-cos-transmit 1 violate drop	Police access-list 102 frames @ Committed information rate 2 mbps, committed bust 2 mbytes, peak information rate 3 mbps, peak burst 2 mbytes when traffic is > CIR and <= PIR, then set the class of service (CoS) field to 1, if traffic violate the action, then drop the frames.
(config-pmap-qos)#exit	Exit Policy-class mode
(config-pmap-qos)#exit	Exit Policy-map mode
(config)#interface xe3	Enter interface mode.
(config-if)#service-policy type qos input 2345	Assign service-policy 2345 to interface on in-direction
(config-if)#exit	Exit interface mode

Validation

Enter the commands below to confirm the configurations.

```
#show running-config qos
qos enable
!
qos statistics
!
class-map type qos 1234
  match cos 2
!
class-map type qos match-any 2345
  match access-group 102
!
policy-map type qos 1234
  class type qos 1234
    police cir 2 mbps pir 3 mbps bc 2 mbytes be 2 mbytes conform transmit exceed set-cos-
transmit 1 violate drop
  exit
policy-map type qos 2345
```



```
class type qos 2345
  police cir 2 mbps pir 3 mbps bc 2 mbytes be 2 mbytes conform transmit exceed set-cos-
transmit 1 violate drop
  exit
!
interface xe2
  service-policy type qos input 1234
!
interface xe3
  service-policy type qos input 2345
#show class-map type qos

Type qos class-maps
=====
  class-map type qos 1234
    match cos 2

  class-map type qos match-any 2345
    match access-group 102

  class-map type qos match-any class-default

#show policy-map type qos

Type qos policy-maps
=====

policy-map type qos 1234
  class type qos 1234
    police colour-aware cir 1 mbps bc 1 mbytes conform set-cos-transmit 5 violate
drop
  exit

policy-map type qos 2345
  class type qos 2345
    police colour-aware cir 2 mbps pir 3 mbps bc 2 mbytes be 2 mbytes conform tran
smit exceed set-cos-transmit 1 violate drop
  exit
#
#show policy-map interface xe2

Interface xe2
Global statistics status : enabled

Service-policy (qos) input      : 1234
-----
Class-map (qos): 1234 (match all)
match cos 3
```

Policing Configuration

```
police cir 2 mbps pir 3 mbps bc 2 mbytes be 2 mbytes conform transmit exceed set-cos-  
transmit 1 violate drop
```

```
    matched      : 7419394 packets, 504519132 bytes
```

```
    dropped      : 7409793 packets, 503866264 bytes
```

Service-policy (queuing) output: default-out-policy

Class-map (queuing): q0

priority

```
    output       : 0 packets, 0 bytes
```

```
    dropped      : 0 packets, 0 bytes
```

Class-map (queuing): q1

priority

```
    output       : 7222 packets, 491096 bytes
```

```
    dropped      : 0 packets, 0 bytes
```

Class-map (queuing): q2

priority

```
    output       : 14444 packets, 982192 bytes
```

```
    dropped      : 0 packets, 0 bytes
```

Class-map (queuing): q3

priority

```
    output       : 0 packets, 0 bytes
```

```
    dropped      : 0 packets, 0 bytes
```

Class-map (queuing): q4

priority

```
    output       : 0 packets, 0 bytes
```

```
    dropped      : 0 packets, 0 bytes
```

Class-map (queuing): q5

priority

```
    output       : 0 packets, 0 bytes
```

```
    dropped      : 0 packets, 0 bytes
```

Class-map (queuing): q6

priority

```
    output       : 0 packets, 0 bytes
```

```
    dropped      : 0 packets, 0 bytes
```

Class-map (queuing): q7

```
priority
  output      : 2 packets, 246 bytes
  dropped     : 0 packets, 0 bytes
```

```
Class-map (queuing): mc-q0
  output      : 0 packets, 0 bytes
  dropped     : 0 packets, 0 bytes
```

```
Class-map (queuing): mc-q1
  output      : 0 packets, 0 bytes
  dropped     : 0 packets, 0 bytes
```

```
Class-map (queuing): mc-q2
  output      : 0 packets, 0 bytes
  dropped     : 0 packets, 0 bytes
```

```
Class-map (queuing): mc-q3
  output      : 0 packets, 0 bytes
  dropped     : 0 packets, 0 bytes
```

```
Class-map (queuing): mc-q4
  output      : 0 packets, 0 bytes
  dropped     : 0 packets, 0 bytes
```

```
Class-map (queuing): mc-q5
  output      : 0 packets, 0 bytes
  dropped     : 0 packets, 0 bytes
```

```
Class-map (queuing): mc-q6
  output      : 0 packets, 0 bytes
  dropped     : 0 packets, 0 bytes
```

```
Class-map (queuing): mc-q7
  output      : 0 packets, 0 bytes
  dropped     : 0 packets, 0 bytes
```

```
Wred Drop Statistics :
```

```
-----
green  : 0 packets
yellow : 0 packets
red    : 0 packets
```

Policing Configuration

```
#show policy-map interface xe3
```

```
Interface xe3
```

```
Global statistics status : enabled
```

```
Service-policy (qos) input      : 2345
```

```
-----  
Class-map (qos): 2345 (match any)  
match access-group 102  
police colour-aware cir 2 mbps pir 3 mbps bc 2 mbytes be 2 mbytes conform trans  
mit exceed set-cos-transmit 1 violate drop  
    matched      : 16218780 packets, 1102879420 bytes
```

```
Service-policy (queuing) output: default-out-policy
```

```
-----  
Class-map (queuing): q0  
priority  
    output      : 0 packets, 0 bytes  
    dropped     : 0 packets, 0 bytes
```

```
Class-map (queuing): q1  
priority  
    output      : 0 packets, 0 bytes  
    dropped     : 0 packets, 0 bytes
```

```
Class-map (queuing): q2  
priority  
    output      : 0 packets, 0 bytes  
    dropped     : 0 packets, 0 bytes
```

```
Class-map (queuing): q3  
priority  
    output      : 0 packets, 0 bytes  
    dropped     : 0 packets, 0 bytes
```

```
Class-map (queuing): q4  
priority  
    output      : 0 packets, 0 bytes  
    dropped     : 0 packets, 0 bytes
```

```
Class-map (queuing): q5
priority
  output      : 18527 packets, 1259836 bytes
  dropped     : 0 packets, 0 bytes
```

```
Class-map (queuing): q6
priority
  output      : 0 packets, 0 bytes
  dropped     : 0 packets, 0 bytes
```

```
Class-map (queuing): q7
priority
  output      : 5 packets, 615 bytes
  dropped     : 0 packets, 0 bytes
```

```
Class-map (queuing): mc-q0
  output      : 0 packets, 0 bytes
  dropped     : 0 packets, 0 bytes
```

```
Class-map (queuing): mc-q1
  output      : 0 packets, 0 bytes
  dropped     : 0 packets, 0 bytes
```

```
Class-map (queuing): mc-q2
  output      : 0 packets, 0 bytes
  dropped     : 0 packets, 0 bytes
```

```
Class-map (queuing): mc-q3
  output      : 0 packets, 0 bytes
  dropped     : 0 packets, 0 bytes
```

```
Class-map (queuing): mc-q4
  output      : 0 packets, 0 bytes
  dropped     : 0 packets, 0 bytes
```

```
Class-map (queuing): mc-q5
  output      : 0 packets, 0 bytes
  dropped     : 0 packets, 0 bytes
```

```
Class-map (queuing): mc-q6
  output      : 0 packets, 0 bytes
```

Policing Configuration

dropped : 0 packets, 0 bytes

Class-map (queuing): mc-q7

output : 0 packets, 0 bytes

dropped : 0 packets, 0 bytes

Wred Drop Statistics :

green : 0 packets

yellow : 0 packets

red : 0 packets

CHAPTER 11 Bandwidth Configuration

This chapter contains a complete sample of configuring Bandwidth.

Topology

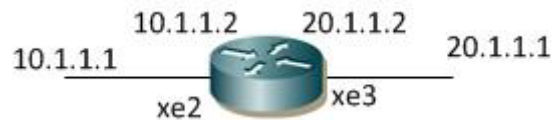

Figure 11-12: Simple configuration of Bandwidth

L2/L3 Interface

The following steps describe how to configure bandwidth.

#configure terminal	Enter configure mode.
(config)#qos enable	Enable QoS globally.
(config)#qos statistics	Enable QoS statistics.
(config)#policy-map type queuing default P1	Configure policy-map of type queuing as default with name P1, and enter into policy-map mode
(config-pmap-que)#class type queuing default q2	Configure class-map of type queuing as default for q0 and enter into class-map mode
(config-pmap-c-que)#bandwidth percent 70	Configure minimum bandwidth as 70 percent of total bandwidth available on interface
(config-pmap-c-que)#exit	Exit out of policy-class mode
(config-pmap-que)#class type queuing default q3	Attach class q3 to Policy-map P1
(config-pmap-c-que)#bandwidth percent 30	Configure minimum bandwidth as 30 percent of remaining bandwidth available on interface after all allocations are done.
(config-pmap-c-que)#exit	Exit out of policy-class mode
(config-pmap-que)#exit	Exit out of Policy-map mode
(config)#class-map type qos c1	Enter Class-map mode
(config-cmap-qos)#match dscp 10	Configure match criteria as dscp 10
(config-cmap-qos)#match cos 3	Configure match criteria as cos 3
(config-cmap-qos)#exit	Exit out of class-map mode
(config)#class-map type qos c2	Enter Class-map mode
(config-cmap-qos)#match dscp 22	Configure match criteria as dscp 22
(config-cmap-qos)#match cos 4	Configure match criteria as cos 4
(config-cmap-qos)#exit	Exit out of class-map mode
(config)#policy-map type qos pmap1	Configure policy-map with name pmap1 and enter policy-map mode

Bandwidth Configuration

(config-pmap-qos)#class type qos c1	Assign Class c1 to Policy-map pmap1
(config-pmap-c-qos)#set precedence 2	Set precedence to value 2
(config-pmap-c-qos)#exit	Exit out of pmap-c mode
(config-pmap-qos)#class type qos c2	Assign Class c2 to Policy-map pmap1
(config-pmap-c-qos)#set cos 2	Set cos to value 2
(config-pmap-c-qos)#exit	Exit out of pmap-c mode
(config)#interface xe3	Enter interface mode
(config-if)#service-policy type queuing output P1	Attach service-policy P1 of type queuing on out direction
(config-if)#exit	Exit out of interface mode
(config)#interface xe2	Enter interface mode
(config-if)#service-policy type qos input pmap1	Attach service-policy pmap1 of type qos on in direction
(config-if)#exit	Exit out of interface mode
(config)#bridge 1 protocol rstp vlan-bridge	Specify VLAN for bridge 1.
(config)#vlan database	Enter the VLAN configuration mode.
(config-vlan)#vlan 2-3 bridge 1 state enable	Enable VLAN (2-3) on bridge 1. Specifying the enable state.
(config-vlan)#exit	Exit the VLAN configuration mode.
(config)#interface vlan1.2	Enter interface mode.
(config-if)# ip address 10.1.1.2/24	Configure the IP address.
(config-if)#exit	Exit the interface mode.
(config)#interface vlan1.3	Enter interface mode.
(config-if)# ip address 20.1.1.1/24	Configure the IP address.
(config-if)#exit	Exit the interface mode.
(config)#interface xe2	Enter interface mode.
(config-if)#switchport	Configure xe2 as a Layer 2 port.
(config-if)#bridge-group 1	Associate the interface with bridge group 1.
(config-if)#switchport mode trunk	Configure port as a trunk.
(config-if)#switchport trunk allowed vlan all	Allow all the VLANs on the xe3 interface.
(config-if)#exit	Exit the interface mode.
(config)#interface xe3	Enter interface mode.
(config-if)#switchport	Configure xe3 as a Layer 2 port.
(config-if)#bridge-group 1	Associate the interface with bridge group 1.
(config-if)#switchport mode trunk	Configure port as a trunk.
(config-if)#switchport trunk allowed vlan all	Allow all the VLANs on the xe3 interface.
(config-if)#exit	Exit the interface mode.

Validation

Enter the commands listed in the sections below to confirm the configurations.

```
#show running-config qos
```

```
qos enable
!
qos statistics
!
class-map type qos c1
  match dscp af11
  match cos 2
!
class-map type qos c2
  match dscp af23
  match cos 4
!
policy-map type qos pmap1
  class type qos c1
    set precedence
    immediate
    exit
  class type qos
    c2
    set cos 2
    exit

!
policy-map type queuing default P1
class type queuing default q1
priority
  bandwidth percent 70
  exit
class type queuing q2
priority
  bandwidth percent 30
  exit
!
!
!
interface xe2
  service-policy type qos input pmap1
!
interface xe3
  service-policy type queuing output P1
!

#show policy-map interface xe2

Interface xe2

Type QoS statistics status : enabled

Class-map (qos): c1 (match all)
  match dscp af11
```

Bandwidth Configuration

```
match cos 3
set precedence 2
```

```
Class-map (qos): c2 (match all)
match dscp af23
match cos 4
set cos 2
```

Type Queuing policy-map : default-out-policy

```
Class-map (queuing): q0
priority
output          : 0 packets, 0 bytes
dropped         : 0 packets, 0 bytes
```

```
Class-map (queuing): q1
priority
output          : 0 packets, 0 bytes
dropped         : 0 packets, 0 bytes
```

```
Class-map (queuing): q2
priority
output          : 0 packets, 0 bytes
dropped         : 0 packets, 0 bytes
```

```
Class-map (queuing): q3
priority
output          : 0 packets, 0 bytes
dropped         : 0 packets, 0 bytes
```

```
Class-map (queuing): q4
priority
output          : 0 packets, 0 bytes
dropped         : 0 packets, 0 bytes
```

```
Class-map (queuing): q5
priority
output          : 0 packets, 0 bytes
dropped         : 0 packets, 0 bytes
```

```
Class-map (queuing): q6
priority
output          : 6 packets, 724 bytes
dropped         : 0 packets, 0 bytes
```

```
Class-map (queuing): q7
priority
output          : 0 packets, 0 bytes
dropped         : 0 packets, 0 bytes
```

```
Class-map (queuing): mc-q0
  output      : 0 packets, 0 bytes
  dropped     : 0 packets, 0 bytes

Class-map (queuing): mc-q1
  output      : 0 packets, 0 bytes
  dropped     : 0 packets, 0 bytes

Class-map (queuing): mc-q2
  output      : 0 packets, 0 bytes
  dropped     : 0 packets, 0 bytes

Class-map (queuing): mc-q3
  output      : 0 packets, 0 bytes
  dropped     : 0 packets, 0 bytes

Class-map (queuing): mc-q4
  output      : 0 packets, 0 bytes
  dropped     : 0 packets, 0 bytes

Class-map (queuing): mc-q5
  output      : 0 packets, 0 bytes
  dropped     : 0 packets, 0 bytes

Class-map (queuing): mc-q6
  output      : 0 packets, 0 bytes
  dropped     : 0 packets, 0 bytes

Class-map (queuing): mc-q7
  output      : 1 packets, 90 bytes
  dropped     : 0 packets, 0 bytes

Wred/Tail Drop Statistics :
-----
green  : 0 packets
yellow : 0 packets
red    : 0 packets

#show policy-map interface xe3

Interface xe3
Type Queuing policy-map : P1

Class-map (queuing): q0
  priority
  output      : 0 packets, 0 bytes
  dropped     : 0 packets, 0 bytes
```

Bandwidth Configuration

Class-map (queuing): q1
priority
output : 0 packets, 0 bytes
dropped : 0 packets, 0 bytes

Class-map (queuing): q2
priority
bandwidth percent 70
output : 0 packets, 0 bytes
dropped : 0 packets, 0 bytes

Class-map (queuing): q3
priority
bandwidth percent 30
output : 0 packets, 0 bytes
dropped : 0 packets, 0 bytes

Class-map (queuing): q4
priority
output : 0 packets, 0 bytes
dropped : 0 packets, 0 bytes

Class-map (queuing): q5
priority
output : 0 packets, 0 bytes
dropped : 0 packets, 0 bytes

Class-map (queuing): q6
priority
output : 0 packets, 0 bytes
dropped : 0 packets, 0 bytes

Class-map (queuing): q7
priority
output : 0 packets, 0 bytes
dropped : 0 packets, 0 bytes

Class-map (queuing): mc-q0
output : 0 packets, 0 bytes
dropped : 0 packets, 0 bytes

Class-map (queuing): mc-q1
output : 0 packets, 0 bytes
dropped : 0 packets, 0 bytes

Class-map (queuing): mc-q2
output : 0 packets, 0 bytes
dropped : 0 packets, 0 bytes

Class-map (queuing): mc-q3

```
output      : 0 packets, 0 bytes
dropped     : 0 packets, 0 bytes
```

```
Class-map (queuing): mc-q4
  output      : 0 packets, 0 bytes
  dropped     : 0 packets, 0 bytes
```

```
Class-map (queuing): mc-q5
  output      : 0 packets, 0 bytes
  dropped     : 0 packets, 0 bytes
```

```
Class-map (queuing): mc-q6
  output      : 0 packets, 0 bytes
  dropped     : 0 packets, 0 bytes
```

```
Class-map (queuing): mc-q7
  output      : 0 packets, 0 bytes
  dropped     : 0 packets, 0 bytes
```

```
Wred/Tail Drop Statistics :
```

```
-----
green  : 0 packets
yellow : 0 packets
red    : 0 packets
```

CHAPTER 12 Shaping Configuration

This chapter contains a complete sample of configuring Shaping.

Topology

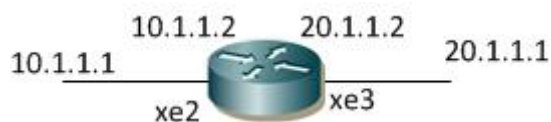

Figure 12-13: Simple configuration of Shaping

L2/L3 Interface

The following steps describe how to configure Shaping.

#configure terminal	Enter configure mode.
(config)#qos enable	Enable QoS globally.
(config)#qos statistics	Enable QoS statistics.
(config)#policy-map type queuing default P1	Configure policy-map of type queuing with name P1, and enter into policy-map mode
(config-pmap-que)#class type queuing default q0	Configure class type queuing of type default and enter into class map configuration mode
(config-pmap-c-que)#shape 200 mbps	Configure shaping to 200 mbps
(config-pmap-c-que)#exit	Exit out of policy-class mode
(config-pmap-que)#exit	Exit out of Policy-map mode
(config)#class-map type qos c1	Enter Class-map mode
(config-cmap-qos)#match dscp 10	Configure match criteria as dscp 10
(config-cmap-qos)#match cos 3	Configure match criteria as cos 3
(config-cmap-qos)#exit	Exit out of class-map mode
(config)#class-map type qos c2	Enter Class-map mode
(config-cmap-qos)#match dscp 22	Configure match criteria as dscp 22
(config-cmap-qos)#match cos 4	Configure match criteria as cos 4
(config-cmap-qos)#exit	Exit out of class-map mode
(config)#policy-map type qos pmap1	Configure policy-map with name pmap1 and enter policy-map mode
(config-pmap-qos)#class type qos c1	Assign Class c1 to Policy-map pmap1
(config-pmap-c-qos)#set queue 2	Set queue 2 for frames with either cos 3 or dscp 10
(config-pmap-c-qos)#exit	Exit out of pmap-c mode
(config-pmap-qos)#class type qos c2	Assign Class c2 to Policy-map pmap1
(config-pmap-c-qos)#set queue 3	Set queue 3 for frames with either cos 4 or dscp 22
(config-pmap-c-qos)#exit	Exit out of pmap-c mode

Shaping Configuration

(config-pmap-qos)#exit	Exit policy-map mode
(config)#interface xe3	Enter interface mode
(config-if)#service-policy type queuing output P1	Attach service-policy P1 of type queuing on out direction
(config-if)#exit	Exit out of interface mode
(config)#interface xe2	Enter interface mode
(config-if)#service-policy type qos input pmap1	Attach service-policy pmap1 of type qos on in direction
(config-if)#exit	Exit out of interface mode
(config)#bridge 1 protocol rstp vlan-bridge	Specify VLAN for bridge 1.
(config)#vlan database	Enter the VLAN configuration mode.
(config-vlan)#vlan 2-3 bridge 1 state enable	Enable VLAN (2-3) on bridge 1. Specifying the enable state.
(config-vlan)#exit	Exit the VLAN configuration mode.
(config)#interface vlan1.2	Enter interface mode.
(config-if)# ip address 10.1.1.2/24	Configure the IP address.
(config-if)#exit	Exit the interface mode.
(config)#interface vlan1.3	Enter interface mode.
(config-if)# ip address 20.1.1.1/24	Configure the IP address.
(config-if)#exit	Exit the interface mode.
(config)#interface xe2	Enter interface mode.
(config-if)#switchport	Configure xe2 as a Layer 2 port.
(config-if)#bridge-group 1	Associate the interface with bridge group 1.
(config-if)#switchport mode trunk	Configure port as a trunk.
(config-if)#switchport trunk allowed vlan all	Allow all the VLANs on the xe3 interface.
(config-if)#exit	Exit the interface mode.
(config)#interface xe3	Enter interface mode.
(config-if)#switchport	Configure xe3 as a Layer 2 port.
(config-if)#bridge-group 1	Associate the interface with bridge group 1.
(config-if)#switchport mode trunk	Configure port as a trunk.
(config-if)#switchport trunk allowed vlan all	Allow all the VLANs on the xe3 interface.
(config-if)#exit	Exit the interface mode

Validation

Enter the commands listed in the sections below to confirm the configurations.

```
#show policy-map type queuing
```

```
Type queuing policy-maps  
=====
```

```
policy-map type queuing default P1  
  class type queuing default q0
```

```
    shape 200 mbps
    priority
class type queuing default q1
    priority
class type queuing default q2
    priority
class type queuing default q3
    priority
class type queuing default q4
    priority
class type queuing default q5
    priority
class type queuing default q6
    priority
class type queuing default q7
    priority

policy-map type queuing default default-out-policy
class type queuing default q0
    priority
    exit
class type queuing default q1
    priority
    exit
class type queuing default q2
    priority
    exit
class type queuing default q3
    priority
    exit
class type queuing default q4
    priority
    exit
class type queuing default q5
    priority
    exit
class type queuing default q6
    priority
    exit
class type queuing default q7
    priority
    exit

#show policy-map type qos
Type qos policy-maps
=====

policy-map type qos pmap1
    class type qos c1
```

Shaping Configuration

```
set queue 2
exit
class type qos c2
set queue 3
exit
```

```
#show class-map type queuing
```

```
Type queuing class-maps
=====
class-map type queuing q0

class-map type queuing q1

class-map type queuing q2

class-map type queuing q3

class-map type queuing q4

class-map type queuing q5

class-map type queuing q6

class-map type queuing q7
```

```
#show class-map type qos
```

```
Type qos class-maps
=====
class-map type qos match-all c1
match cos 3
match dscp af11

class-map type qos match-all c2
match cos 4
match dscp af23
```

```
#show queuing interface xe2
```

```
Egress Queuing for Ethernet xe2 [System]
```

```
-----
-----
L0          L1          L2          Group  PrioLevel  Shape          Bandwidth
-----
-----
q0          -          High        200 mbps  -
q1          -          High        -          -
q2          -          High        -          -
q3          -          High        -          -
q4          -          High        -          -
q5          -          High        -          -
```

```

q6                -      High      -      -
q7                -      High      -      -

#show queuing interface xe3

Egress Queuing for Ethernet xe3 [System]
-----
L0                L1                L2                Group  PrioLevel  Shape          Bandwidth
-----
q0                -      High      -      -
q1                -      High      -      -
q2                -      High      -      -
q3                -      High      -      -
q4                -      High      -      -
q5                -      High      -      -
q6                -      High      -      -
q7                -      High      -      -

#show policy-map interface xe3

Interface xe3
Type QoS statistics status : enabled

Class-map (qos): c1 (match all)
  match dscp af11
  match cos 3
  set queue 2

Class-map (qos): c2 (match all)
  match dscp af23
  match cos 4
  set queue 3

Type Queuing policy-map : default-out-policy

Class-map (queuing): q0
  priority
    output          : 0 packets, 0 bytes
    dropped         : 0 packets, 0 bytes

Class-map (queuing): q1
  priority
    output          : 0 packets, 0 bytes
    dropped         : 0 packets, 0 bytes

Class-map (queuing): q2
  priority
    output          : 0 packets, 0 bytes
    dropped         : 0 packets, 0 bytes

```

Shaping Configuration

```
Class-map (queuing): q3
  priority
    output          : 0 packets, 0 bytes
    dropped         : 0 packets, 0 bytes

Class-map (queuing): q4
  priority
    output          : 0 packets, 0 bytes
    dropped         : 0 packets, 0 bytes

Class-map (queuing): q5
  priority
    output          : 0 packets, 0 bytes
    dropped         : 0 packets, 0 bytes

Class-map (queuing): q6
  priority
    output          : 6 packets, 724 bytes
    dropped         : 0 packets, 0 bytes

Class-map (queuing): q7
  priority
    output          : 0 packets, 0 bytes
    dropped         : 0 packets, 0 bytes

Class-map (queuing): mc-q0
  output          : 0 packets, 0 bytes
  dropped         : 0 packets, 0 bytes

Class-map (queuing): mc-q1
  output          : 0 packets, 0 bytes
  dropped         : 0 packets, 0 bytes

Class-map (queuing): mc-q2
  output          : 0 packets, 0 bytes
  dropped         : 0 packets, 0 bytes

Class-map (queuing): mc-q3
  output          : 0 packets, 0 bytes
  dropped         : 0 packets, 0 bytes

Class-map (queuing): mc-q4
  output          : 0 packets, 0 bytes
  dropped         : 0 packets, 0 bytes

Class-map (queuing): mc-q5
  output          : 0 packets, 0 bytes
  dropped         : 0 packets, 0 bytes
```

```
Class-map (queuing): mc-q6
  output      : 0 packets, 0 bytes
  dropped     : 0 packets, 0 bytes

Class-map (queuing): mc-q7
  output      : 1 packets, 90 bytes
  dropped     : 0 packets, 0 bytes

Wred/Tail Drop Statistics :
-----
green  : 0 packets
yellow : 0 packets
red    : 0 packets
```

CHAPTER 13 Scheduling Configuration

This chapter contains a complete sample of configuring weight, strict priority on queues and weight between uc and mc queue.

Topology

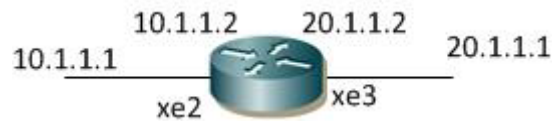

Figure 13-14: Simple configuration of Priority

Configuring Weight on L2 /L3 Interface

#configure terminal	Enter configure mode.
(config)#qos enable	Enable QoS globally.
(config)#qos statistics	Enable QoS statistics.
(config)#policy-map type queuing default default-out-policy	Enter policy-map type queueing default.
(config-pmap-que-def)#class type queuing default q0	Enter policy-class-map mode.
(config-pmap-c-que-def)#wrr-queue weight 2	Modify strict queue to wrr-queue with weight 2.
(config-pmap-c-que-def)#exit	Exit from policy-class-map mode.
(config-pmap-que-def)#exit	Exit from policy-map mode.
(config)#exit	Exit configure mode.

Validation

Enter the commands listed in the sections below to confirm the configurations.

```
#show policy-map type queuing
```

```
Type queuing policy-maps
=====
```

```
policy-map type queuing default default-out-policy
  class type queuing default q0
    wrr-queue weight 2
  class type queuing default q1
    priority
  class type queuing default q2
    priority
  class type queuing default q3
    priority
```

```
class type queuing default q4
  priority
class type queuing default q5
  priority
class type queuing default q6
  priority
class type queuing default q7
  priority
```

Configuring Strict priority on L2 /L3 Interface

#configure terminal	Enter configure mode.
(config)#qos enable	Enable QoS globally.
(config)#qos statistics	Enable QoS statistics.
(config)#policy-map type queuing default p3	Enter policy-map type queueing default.
(config-pmap-que-def)#class type queuing default q0	Enter policy-class-map mode.
(config-pmap-c-que-def)#priority	Configure priority for q0.
(config-pmap-c-que-def)#exit	Exit from policy-class-map mode.
(config-pmap-que-def)#exit	Exit from policy-map mode.
(config)#interface xe2	Enter interface mode.
(config-if)#service-policy type queuing output p3	Attach policy-map of type queuing on egress interface
(config)#exit	Exit configure mode.

Validation

Enter the commands listed in the sections below to confirm the configurations.

```
# show running-config qos
qos enable
qos statistics
!
!
policy-map type queuing default p3
  class type queuing default q0
    priority
  exit
!
interface xe2
  service-policy type queuing output p3
!

# show policy-map type queuing

Type queuing policy-maps
=====
```



```

policy-map type queuing default default-out-policy
  class type queuing default q0
    priority
  class type queuing default q1
    priority
  class type queuing default q2
    priority
  class type queuing default q3
    priority
  class type queuing default q4
    priority
  class type queuing default q5
    priority
  class type queuing default q6
    priority
  class type queuing default q7
    priority

```

```

policy-map type queuing default p3
  class type queuing default q0
    priority
  class type queuing default q1
    priority
  class type queuing default q2
    priority
  class type queuing default q3
    priority
  class type queuing default q4
    priority
  class type queuing default q5
    priority
  class type queuing default q6
    priority
  class type queuing default q7
    priority

```

OcNOS#

Configuring weight between unicast and multicast queues

Use the following configuration to set weights between unicast and multicast traffic of same traffic class.

#configure terminal	Enter configure mode.
(config)#qos enable	Enable QoS globally.
(config)#qos statistics	Enable QoS statistics.
(config)# set qos wrr uc 3 non-uc 1	Schedule unicast and multicast traffic in 3:1
(config)#exit	Exit configure mode.

Note: Unicast weight should be always higher than multicast weight (except on Trident+ platforms). Between unicast and multicast traffic of different traffic class, scheduling will be as per configuration given in the queuing policy-

map attached on the interface.

This hardware limitation is for Trident3 platform which is scheduled between unicast and multicast that requires the unicast weight to be higher than the multicast queues weights.

Validation

Enter the commands listed in the sections below to confirm the configurations.

```
#sh run qos
qos enable
qos statistics
set qos wrr uc 3 non-uc 1
!
```

```
#show int cou queue-stats
E - Egress, I - Ingress, Q-Size is in bytes
* indicates monitor is active
```

Interface	Queue/Class-map	Q-Size	Tx pkts	Tx bytes
ce1/1	q1 (E)	373152	1256	1256000
15241000				15245
ce1/1	mc-q1 (E)	92352	418	418000
16045000				16048
ce24/1	pg-q0 (I)	419536	NA	NA
NA				
ce24/1	pg-q1 (I)	468000	NA	NA
NA				

Validation

Enter the commands listed in the sections below to confirm the configurations.

```
#show policy-map type queuing default default-out-policy Type queuing policy-maps
=====
```

```
policy-map type queuing default default-out-policy class type queuing default q0
wrr-queue weight 2
bandwidth percent 1 exit
class type queuing default q1 priority level 1
bandwidth percent 1 exit
class type queuing default q2 priority level 1
```

```
bandwidth percent 1 exit
class type queuing default q3 priority level 1
bandwidth percent 1 exit
class type queuing default q4 priority level 1
bandwidth percent 1 exit
class type queuing default q5 priority level 1
```

```
bandwidth percent 1 exit
class type queuing default q6 priority level 1
bandwidth percent 1 exit
class type queuing default q7 priority level 1
bandwidth percent 1 exit
```

```
#show queuing interface xe2
```

```
Egress Queuing for Ethernet xe2 [System]
```

```
L0 L1 L2 GroupPrioLevelShape Bandwidth
```

```
q0 - - -
-
q1 - High-
-
q2 - High-
-
q3 - High-
-
q4 - High-
-
q5 - High-
-
q6 - High-
-
q7 - High-
-
#
```

Note: Unicast weight should be always higher than multicast weight. Between unicast and multicast traffic of different traffic class, scheduling will be as per configuration given in the queuing policy-map attached on the interface.

#configure terminal	Enter configure mode.
(config)#qos enable	Enable QoS globally.
(config)#qos statistics	Enable QoS statistics.
(config)# set qos wrr uc 1 non-uc 1	Schedule unicast and multicast traffic in 1:1
(config)#exit	Exit configure mode.

Validation

Enter the commands listed in the sections below to confirm the configurations.

```
#show running-configuration qos
qos enable
qos statistics
set qos wrr uc 1 non-uc 1
!
```

Scheduling Configuration

```
#show policy-map
```

```
Type queuing policy-maps
```

```
=====
```

```
policy-map type queuing default default-out-policy
```

```
class type queuing default q0
```

```
priority
```

```
class type queuing default q1
```

```
priority
```

```
class type queuing default q2
```

```
priority
```

```
class type queuing default q3
```

```
priority
```

```
class type queuing default q4
```

```
priority
```

```
class type queuing default q5
```

```
priority
```

```
class type queuing default q6
```

```
priority
```

```
class type queuing default q7
```

```
priority
```

```
#show interface counters queue-stats
```

```
E - Egress, I - Ingress, Q-Size is in bytes
```

```
* indicates monitor is active
```

```
+-----+-----+-----+-----+-----+-----+
| Interface | Queue/Class-map | Q-Size | Tx pkts | Tx bytes |
| Dropped pkts | Dropped bytes | | | |
+-----+-----+-----+-----+-----+-----+
cpu        bpdu        (E) 0      1         68         0
0
ce1/1     q1          (E) 424320 0         0          16817
16814000
ce1/1     q7          (E) 0      1         64         0
0
ce1/1     mc-q2      (E) 102336 1710     1710000    15059
15055000
ce24/1    q7          (E) 0      1         64         0
0
ce24/1    pg-q1      (I) 509600 NA        NA         NA
NA
ce24/1    pg-q2      (I) 103584 NA        NA         NA
NA
```

By default, default-out-policy with priority on all queues is applied on ce1/1, hence receiving only q2 multicast traffic

```
#show interface counters queue-stats
```

```
E - Egress, I - Ingress, Q-Size is in bytes
```

```
* indicates monitor is active
```

Interface	Queue/Class-map	Q-Size	Tx pkts	Tx bytes
cpu	bpdu	(E) 0	1	0
ce1/1	q1	(E) 424320	816	15279
ce1/1	q7	(E) 0	1	0
ce1/1	mc-q1	(E) 106080	816	15229
ce24/1	q7	(E) 0	1	0
ce24/1	pg-q1	(I) 513344	NA	NA

#configure terminal	Enter configure mode.
(config)#qos enable	Enable QoS globally.
(config)#qos statistics	Enable QoS statistics.
(config)#policy-map type queuing default default-out-policy	Enter policy-map type queuing default.
(config-pmap-que-def)#class type queuing default q0	Enter policy-class-map mode.
(config-pmap-c-que-def)#wrr-queue weight 2	Modify strict queue to wrr-queue with weight 2.
(config-pmap-c-que-def)# class type queuing default q1	
(config-pmap-c-que-def)# wrr-queue weight 2	
(config-pmap-c-que-def)# class type queuing default q2	
(config-pmap-c-que-def)#wrr-queue weight 4	
(config-pmap-c-que-def)#exit	Exit from policy-class-map mode.
(config-pmap-que-def)#exit	Exit from policy-map mode.
(config)#exit	Exit configure mode.

Validation

```
#show policy-map
```

```
Type queuing policy-maps
```

```
=====
policy-map type queuing default default-out-policy
  class type queuing default q0
wrr-queue weight 2
  class type queuing default q1
wrr-queue weight 2
```

Scheduling Configuration

```
class type queuing default q2
wrr-queue weight 4
class type queuing default q3
priority
class type queuing default q4
priority
class type queuing default q5
priority
class type queuing default q6
priority
class type queuing default q7
priority
```

```
#show interface counters queue-stats
E - Egress, I - Ingress, Q-Size is in bytes
* indicates monitor is active
```

Interface	Queue/Class-map	Q-Size	Tx pkts	Tx bytes
cpu	bpdu	(E) 0	1	68
0				0
ce1/1	q1	(E) 421824	312	312000
8954000				8957
ce1/1	q7	(E) 0	1	64
0				0
ce1/1	mc-q2	(E) 106080	624	624000
8592000				8607
ce24/1	q7	(E) 0	1	64
0				0
ce24/1	pg-q1	(I) 411008	NA	NA
NA				
ce24/1	pg-q2	(I) 106080	NA	NA
NA				

CHAPTER 14 WRED Configuration

This chapter contains a complete sample of configuring WRED.

Topology

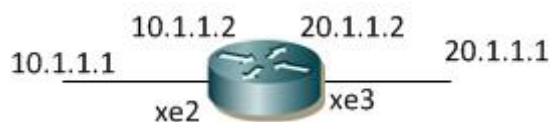

Figure 14-15: Simple configuration of WRED

L2/L3 Interface

The following steps describe how to configure WRED.

#configure terminal	Enter configure mode.
(config)#qos enable	Enable QoS globally.
(config)#qos statistics	Enable QoS statistics.
(config)#class-map type qos match-all C1	Configure class-map of type qos with name C1, and enter into class-map mode
(config-cmap-que)#match cos 1	Configure match cos value 1
(config-cmap-que)#exit	Exit out of class-map mode
(config)#policy-map type qos p1	Configure plicy-map of type qos with name p1, and enter into policy-map mode
(config-cmap-que)#class type qos C1	Enter class-map configuration mode
(config-cmap-que)# police cir 100 mbps pir 200 mbpsexit	Configure police rate of cir 100 mbps and pir 200 mbpsExit out of class-map mode
(config-pmap-c-que)#exit	Exit out of policy-class mode
(config-pmap-qos)#exi	Exit out of policy-class mode
(config)#policy-map type queuing default p3	Configure policy-map of type queuing with name p3, and enter into policy-map mode
(config-cmap-que)#class type queuing default q0	Enter class type of type queuing default configuration mode for q0
(config-pmap-c-que-def)#wrr-queue weight 10	Configure WRR weight of 10
(config-pmap-c-que-def)#random-detect min-threshold 50 max-threshold 80 kbytes	Configure WRED for minimum threshold of 50 kbytest and maximum threshold of 80 kbytes of queue size.
(config-pmap-c-que-def)#exit	Exit out of class configuration mode
(config)#interface xe3	Enter interface mode
(config-if)#service-policy type queuing output P3	Attach service-policy p3 of type queuing on out direction
(config-if)#exit	Exit out of interface mode
(config)#interface xe2	Enter interface mode
(config-if)#service-policy type qos input p1	Attach service-policy p1 of type qos on in direction

WRED Configuration

(config-if)#exit	Exit out of interface mode
(config)#bridge 1 protocol rstp vlan-bridge	Specify VLAN for bridge 1.
(config)#vlan database	Enter the VLAN configuration mode.
(config-vlan)#vlan 2-3 bridge 1 state enable	Enable VLAN (2-3) on bridge 1. Specifying the enable state.
(config-vlan)#exit	Exit the VLAN configuration mode.
(config)#interface vlan1.2	Enter interface mode.
(config-if)# ip address 10.1.1.2/24	Configure the IP address.
(config-if)#exit	Exit the interface mode.
(config)#interface vlan1.3	Enter interface mode.
(config-if)# ip address 20.1.1.1/24	Configure the IP address.
(config-if)#exit	Exit the interface mode.
(config)#interface xe2	Enter interface mode.
(config-if)#switchport	Configure xe2 as a Layer 2 port.
(config-if)#bridge-group 1	Associate the interface with bridge group 1.
(config-if)#switchport mode trunk	Configure port as a trunk.
(config-if)#switchport trunk allowed vlan all	Allow all the VLANs on the xe3 interface.
(config-if)#exit	Exit the interface mode.
(config)#interface xe3	Enter interface mode.
(config-if)#switchport	Configure xe3 as a Layer 2 port.
(config-if)#bridge-group 1	Associate the interface with bridge group 1.
(config-if)#switchport mode trunk	Configure port as a trunk.
(config-if)#switchport trunk allowed vlan all	Allow all the VLANs on the xe3 interface.
(config-if)#exit	Exit the interface mode.

Validation

Enter the commands below to confirm the configurations.

```
#show running-config qos
os enable
qos statistics
!
class-map type qos match-all 1
!
class-map type qos match-all C1
  match cos 1
!
policy-map type qos p1
  class type qos C1
    police cir 100 mbps pir 200 mbps
  exit
!
!
policy-map type queuing default p3
```

```
class type queuing default q0
  wrr-queue weight 10
  random-detect min-threshold 50 max-threshold 80 kbytes drop-probability 80
  exit
!
interface xe2
  service-policy type qos input p1
!
interface xe3
service-policy type queuing output p3

#show policy-map interface xe2

Interface xe2
Type QoS statistics status : enabled
Class-map (qos): C1 (match all)
  match cos 1
  police cir 100 mbps pir 200 mbps

Type Queuing policy-map : default-out-policy

Class-map (queuing): q0
  priority
    output          : 0 packets, 0 bytes
    dropped         : 0 packets, 0 bytes

Class-map (queuing): q1
  priority
    output          : 0 packets, 0 bytes
    dropped         : 0 packets, 0 bytes

Class-map (queuing): q2
  priority
    output          : 0 packets, 0 bytes
    dropped         : 0 packets, 0 bytes

Class-map (queuing): q3
  priority
    output          : 0 packets, 0 bytes
    dropped         : 0 packets, 0 bytes

Class-map (queuing): q4
  priority
    output          : 0 packets, 0 bytes
    dropped         : 0 packets, 0 bytes

Class-map (queuing): q5
  priority
    output          : 0 packets, 0 bytes
```

WRED Configuration

dropped : 0 packets, 0 bytes

Class-map (queuing): q6

priority

output : 6 packets, 724 bytes

dropped : 0 packets, 0 bytes

Class-map (queuing): q7

priority

output : 0 packets, 0 bytes

dropped : 0 packets, 0 bytes

Class-map (queuing): mc-q0

output : 0 packets, 0 bytes

dropped : 0 packets, 0 bytes

Class-map (queuing): mc-q1

output : 0 packets, 0 bytes

dropped : 0 packets, 0 bytes

Class-map (queuing): mc-q2

output : 0 packets, 0 bytes

dropped : 0 packets, 0 bytes

Class-map (queuing): mc-q3

output : 0 packets, 0 bytes

dropped : 0 packets, 0 bytes

Class-map (queuing): mc-q4

output : 0 packets, 0 bytes

dropped : 0 packets, 0 bytes

Class-map (queuing): mc-q5

output : 0 packets, 0 bytes

dropped : 0 packets, 0 bytes

Class-map (queuing): mc-q6

output : 0 packets, 0 bytes

dropped : 0 packets, 0 bytes

Class-map (queuing): mc-q7

output : 1 packets, 90 bytes

dropped : 0 packets, 0 bytes

Wred/Tail Drop Statistics :

green : 0 packets

yellow : 0 packets

red : 0 packets

```
#show policy-map interface xe3

Interface xe3
Type Queuing policy-map : p3
Class-map (queuing): q0
  wrr-queue weight 10
  random-detect min-threshold 50 kbytes max-threshold 80 kbytes drop-probability 80
  weight 8
    output          : 0 packets, 0 bytes
    dropped         : 0 packets, 0 bytes

Class-map (queuing): q1
  priority
    output          : 0 packets, 0 bytes
    dropped         : 0 packets, 0 bytes

Class-map (queuing): q2
  priority
    output          : 0 packets, 0 bytes
    dropped         : 0 packets, 0 bytes

Class-map (queuing): q3
  priority
    output          : 0 packets, 0 bytes
    dropped         : 0 packets, 0 bytes

Class-map (queuing): q4
  priority
    output          : 0 packets, 0 bytes
    dropped         : 0 packets, 0 bytes

Class-map (queuing): q5
  priority
    output          : 0 packets, 0 bytes
    dropped         : 0 packets, 0 bytes

Class-map (queuing): q6
  priority
    output          : 0 packets, 0 bytes
    dropped         : 0 packets, 0 bytes

Class-map (queuing): q7
  priority
    output          : 0 packets, 0 bytes
    dropped         : 0 packets, 0 bytes

Class-map (queuing): mc-q0
  output          : 0 packets, 0 bytes
  dropped         : 0 packets, 0 bytes

Class-map (queuing): mc-q1
  output          : 0 packets, 0 bytes
```

WRED Configuration

dropped : 0 packets, 0 bytes

Class-map (queuing): mc-q2

output : 0 packets, 0 bytes

dropped : 0 packets, 0 bytes

Class-map (queuing): mc-q3

output : 0 packets, 0 bytes

dropped : 0 packets, 0 bytes

Class-map (queuing): mc-q4

output : 0 packets, 0 bytes

dropped : 0 packets, 0 bytes

Class-map (queuing): mc-q5

output : 0 packets, 0 bytes

dropped : 0 packets, 0 bytes

Class-map (queuing): mc-q6

output : 0 packets, 0 bytes

dropped : 0 packets, 0 bytes

Class-map (queuing): mc-q7

output : 0 packets, 0 bytes

dropped : 0 packets, 0 bytes

Wred/Tail Drop Statistics :

green : 0 packets

yellow : 0 packets

red : 0 packets

#show queuing interface xe1/2

Egress Queuing for Ethernet ce2/1 [System]

L0	L1	L2	Group	PrioLevel	Shape	Bandwidth
q0			-	High	-	-
q1			-	High	-	-
q2			-	High	-	-
q3			-	High	-	-
q4			-	High	-	-
q5			-	High	-	-
q6			-	High	-	-
q7			-	High	-	-

CHAPTER 15 Tail-Drop Configuration

Topology

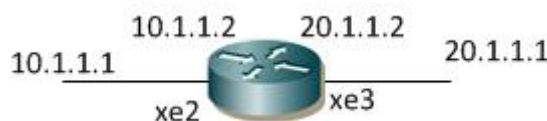

Figure 15-16: Simple configuration of Tail-Drop

Configuring Tail-Drop

The following steps describe how to configure Tail-Drop.

Configuration on L2/L3 Interfaces

Do the following to configure Tail-Drop on a queue.

#configure terminal	Enter configure mode.
(config)#qos enable	Enable QoS globally.
(config)#qos statistics	Enable QoS statistics.
(config)#class-map type qos match-all C1	Configure class-map of type qos with name C1, and enter into class-map mode
(config-cmap-que)#match cos 1	match cos value 1
(OcNOS (config-cmap-qos) #exit	Exit out of class-map
(config)#policy-map type qos p1	Enter policy-map configuration mode of type qos
(config-cmap-que)#class type qos C1	Enter class-map configuration mode
(config-cmap-que)# police cir 100 mbps pir 200 mbps	Configure police rate of cir 100 mbps and pir 200 mbps
(config-pmap-c-que)#exit	Exit out of policy-class mode
(config-pmap-qos)#exit	Exit out of policy-class mode
(config)#policy-map type queuing default p3	Configure policy-map of type queuing with name p3 and enter into policy-map mode
(config-cmap-que)#class type queuing default q1	Enter class type of type queuing default configuration mode for q1
(config-pmap-c-que)#shape percent 20	Configure shaping to 20 percent of bandwidth available on interface
(config-pmap-c-que)#exit	Exit out of policy-class mode
(config-pmap-que)#class type queuing default q2	Enter class type of type queuing default configuration mode for q2
(config-pmap-c-que)#bandwidth 25000 kbps	Configure bandwidth to 25000 kbps
(config-pmap-c-que)#queue-limit 99 packets	Configure tail-drop to 99 packets
(config-pmap-c-que)#exit	Exit out of policy-class mode

Tail-Drop Configuration

(config-pmap-que)#class type queuing default q3	Enter class type of type queuing default configuration mode for q3
(config-pmap-c-que)#queue-limit 101 packets	Configure tail-drop to 101 packets
(config-pmap-c-que)#exit	Exit out of policy-class mode
(config-pmap-que)#exit	Exit out of policy-map mode
(config)#interface xe2	Enter interface mode
(config-if)#service-policy type queuing output p3	Attach service-policy p3 of type queuing on out direction
(config-if)#exit	Exit out of interface mode
(config)#interface xe3	Enter interface mode
(config-if)#service-policy type qos input p1	Attach service-policy p1 of type qos on in direction
(config-if)#exit	Exit out of interface mode
(config)#bridge 1 protocol rstp vlan-bridge	Specify VLAN for bridge 1.
(config)#vlan database	Enter the VLAN configuration mode.
(config-vlan)#vlan 2-3 bridge 1 state enable	Enable VLAN (2-3) on bridge 1. Specifying the enable state.
(config-vlan)#exit	Exit the VLAN configuration mode.
(config)#interface vlan1.2	Enter interface mode.
(config-if)# ip address 10.1.1.2/24	Configure the IP address.
(config-if)#exit	Exit the interface mode.
(config)#interface vlan1.3	Enter interface mode.
(config-if)# ip address 20.1.1.1/24	Configure the IP address.
(config-if)#exit	Exit the interface mode.
(config)#interface xe2	Enter interface mode.
(config-if)#switchport	Configure xe2 as a Layer 2 port.
(config-if)#bridge-group 1	Associate the interface with bridge group 1.
(config-if)#switchport mode trunk	Configure port as a trunk.
(config-if)#switchport trunk allowed vlan all	Allow all the VLANs on the xe3 interface.
(config-if)#exit	Exit the interface mode.
(config)#interface xe3	Enter interface mode.
(config-if)#switchport	Configure xe3 as a Layer 2 port.
(config-if)#bridge-group 1	Associate the interface with bridge group 1.
(config-if)#switchport mode trunk	Configure port as a trunk.
(config-if)#switchport trunk allowed vlan all	Allow all the VLANs on the xe3 interface.
(config-if)#exit	Exit the interface mode.

Validation

Enter the commands below to confirm the configurations.

```
#show running-config qos
qos enable
!
qos statistics
```

```
!  
class-map type qos match-all C1  
  match cos 1  
!  
policy-map type qos p1  
  class type qos C1  
    police cir 100 mbps pir 200 mbps  
  exit  
!  
!  
policy-map type queuing default p3  
  class type queuing default q1  
    shape percent 20  
    priority  
  exit  
  class type queuing default q2  
    priority  
    queue-limit 99 packets  
    bandwidth 25000 kbps  
  exit  
  class type queuing default q3  
    priority  
    queue-limit 101 packets  
  exit  
  
#show class-map  
Type qos class-maps  
=====  
    class-map type qos match-all C1  
      match cos 1  
  
    class-map type qos match-any class-default  
  
Type queuing class-maps  
=====  
    class-map type queuing q0  
  
    class-map type queuing q1  
  
    class-map type queuing q2  
  
    class-map type queuing q3  
  
    class-map type queuing q4  
  
    class-map type queuing q5  
  
    class-map type queuing q6
```

Tail-Drop Configuration

```
class-map type queuing q7
```

```
Type Vlan-Queuing class-maps
```

```
#show policy-map
```

```
Type qos policy-maps
```

```
=====
```

```
policy-map type qos p1  
  class type qos C1  
    police cir 100 mbps pir 200 mbps
```

```
Type queuing policy-maps
```

```
=====
```

```
policy-map type queuing default default-out-policy  
  class type queuing default q0  
    priority  
  class type queuing default q1  
    priority  
  class type queuing default q2  
    priority  
  class type queuing default q3  
    priority  
  class type queuing default q4  
    priority  
  class type queuing default q5  
    priority  
  class type queuing default q6  
    priority  
  class type queuing default q7  
    priority
```

```
policy-map type queuing default p3  
  class type queuing default q0  
    priority  
  class type queuing default q1  
    shape percent 20  
    priority  
  class type queuing default q2  
    priority  
    queue-limit 99 packets  
    bandwidth 25000 kbps  
  class type queuing default q3  
    priority  
    queue-limit 101 packets
```

```
class type queuing default q4
  priority
class type queuing default q5
  priority
class type queuing default q6
  priority
class type queuing default q7
  priority

#show policy-map interface xe2

QoS statistics status : enabled

Class-map (qos): C1 (match all)
  match cos 1
  police cir 100 mbps pir 200 mbps

Type Queuing policy-map : default-out-policy

Class-map (queuing): q0
  priority
    output          : 0 packets, 0 bytes
    dropped         : 0 packets, 0 bytes

Class-map (queuing): q1
  priority
    output          : 0 packets, 0 bytes
    dropped         : 0 packets, 0 bytes

Class-map (queuing): q2
  priority
    output          : 0 packets, 0 bytes
    dropped         : 0 packets, 0 bytes

Class-map (queuing): q3
  priority
    output          : 0 packets, 0 bytes
    dropped         : 0 packets, 0 bytes

Class-map (queuing): q4
  priority
    output          : 0 packets, 0 bytes
    dropped         : 0 packets, 0 bytes

Class-map (queuing): q5
  priority
    output          : 0 packets, 0 bytes
    dropped         : 0 packets, 0 bytes
```

Tail-Drop Configuration

```
Class-map (queuing): q6
  priority
    output          : 6 packets, 724 bytes
    dropped         : 0 packets, 0 bytes
```

```
Class-map (queuing): q7
  priority
    output          : 0 packets, 0 bytes
    dropped         : 0 packets, 0 bytes
```

```
Class-map (queuing): mc-q0
  output          : 0 packets, 0 bytes
  dropped         : 0 packets, 0 bytes
```

```
Class-map (queuing): mc-q1
  output          : 0 packets, 0 bytes
  dropped         : 0 packets, 0 bytes
```

```
Class-map (queuing): mc-q2
  output          : 0 packets, 0 bytes
  dropped         : 0 packets, 0 bytes
```

```
Class-map (queuing): mc-q3
  output          : 0 packets, 0 bytes
  dropped         : 0 packets, 0 bytes
```

```
Class-map (queuing): mc-q4
  output          : 0 packets, 0 bytes
  dropped         : 0 packets, 0 bytes
```

```
Class-map (queuing): mc-q5
  output          : 0 packets, 0 bytes
  dropped         : 0 packets, 0 bytes
```

```
Class-map (queuing): mc-q6
  output          : 0 packets, 0 bytes
  dropped         : 0 packets, 0 bytes
```

```
Class-map (queuing): mc-q7
  output          : 1 packets, 90 bytes
  dropped         : 0 packets, 0 bytes
```

```
Wred/Tail Drop Statistics :
```

```
-----
green  : 0 packets
yellow : 0 packets
red    : 0 packets
```

```
#show policy-map interface xe3
```

```
Type Queuing policy-map : p3

Class-map (queuing): q0
  priority
    output          : 0 packets, 0 bytes
    dropped         : 0 packets, 0 bytes

Class-map (queuing): q1
  shape percent 20
  priority
    output          : 0 packets, 0 bytes
    dropped         : 0 packets, 0 bytes

Class-map (queuing): q2
  priority
  queue-limit 99 packets
  bandwidth 25000 kbps
    output          : 0 packets, 0 bytes
    dropped         : 0 packets, 0 bytes

Class-map (queuing): q3
  priority
  queue-limit 101 packets
    output          : 0 packets, 0 bytes
    dropped         : 0 packets, 0 bytes

Class-map (queuing): q4
  priority
    output          : 0 packets, 0 bytes
    dropped         : 0 packets, 0 bytes

Class-map (queuing): q5
  priority
    output          : 0 packets, 0 bytes
    dropped         : 0 packets, 0 bytes

Class-map (queuing): q6
  priority
    output          : 0 packets, 0 bytes
    dropped         : 0 packets, 0 bytes

Class-map (queuing): q7
  priority
    output          : 0 packets, 0 bytes
    dropped         : 0 packets, 0 bytes

Class-map (queuing): mc-q0
  output          : 0 packets, 0 bytes
  dropped         : 0 packets, 0 bytes
```

Tail-Drop Configuration

```
Class-map (queuing): mc-q1
  output      : 0 packets, 0 bytes
  dropped     : 0 packets, 0 bytes
```

```
Class-map (queuing): mc-q2
  output      : 0 packets, 0 bytes
  dropped     : 0 packets, 0 bytes
```

```
Class-map (queuing): mc-q3
  output      : 0 packets, 0 bytes
  dropped     : 0 packets, 0 bytes
```

```
Class-map (queuing): mc-q4
  output      : 0 packets, 0 bytes
  dropped     : 0 packets, 0 bytes
```

```
Class-map (queuing): mc-q5
  output      : 0 packets, 0 bytes
  dropped     : 0 packets, 0 bytes
```

```
Class-map (queuing): mc-q6
  output      : 0 packets, 0 bytes
  dropped     : 0 packets, 0 bytes
```

```
Class-map (queuing): mc-q7
  output      : 0 packets, 0 bytes
  dropped     : 0 packets, 0 bytes
```

Wred/Tail Drop Statistics :

```
-----
green  : 0 packets
yellow : 0 packets
red    : 0 packets
```

OcNOS#show queuing interface xe2

Egress Queuing for Ethernet xe2 [System]

L0	L1	L2	Group	PrioLevel	Shape	Bandwidth
q0			-	High	-	-
q1			-	High	-	-
q2			-	High	-	-
q3			-	High	-	-
q4			-	High	-	-
q5			-	High	-	-
q6			-	High	-	-
q7			-	High	-	-

OcNOS#show queuing interface xe3

Egress Queuing for Ethernet xe3 [System]

L0	L1	L2	Group	PrioLevel	Shape	Bandwidth
q0			-	High	-	-
q1			-	High	20 percent	-
q2			-	High	-	25000 kbps
q3			-	High	-	-
q4			-	High	-	-
q5			-	High	-	-
q6			-	High	-	-
q7			-	High	-	-

CHAPTER 16 Hierarchical Queuing Configuration

This chapter contains a complete sample of configuring hierarchical queuing.

Topology



Figure 16-17: Simple configuration of Hierarchical Queuing

Configuring Hierarchical Queuing

Do the following to configure 3-level hierarchical queuing on an interface.

#configure terminal	Enter configure mode.
(config)#qos enable	Enable QoS globally.
(config)#qos statistics	Enable QoS statistics.
(config)#class-map type qos match-any C_QOS1	Configure class-map C_QOS1 of type qos and enter into class-map mode
(config-cmap-qos)#match cos 0	Configure match criteria as cos 0
(config-cmap-qos)#match dscp 0-7	Configure match criteria as dscp 0-7
(config-cmap-qos)#exit	Exit out of cmap mode
(config)#class-map type qos match-any C_QOS2	Configure class-map C_QOS2 of type qos and enter into class-map mode
(config-cmap-qos)#match cos 1	Configure match criteria as cos 1
(config-cmap-qos)#match dscp 8-15	Configure match criteria as dscp 8-15
(config-cmap-qos)#exit	Exit out of cmap mode
(config)#class-map type qos match-any C_QOS3	Configure class-map C_QOS3 of type qos and enter into class-map mode
(config-cmap-qos)#match cos 2	Configure match criteria as cos 2
(config-cmap-qos)#match dscp 16-23	Configure match criteria as dscp 16-23
(config-cmap-qos)#exit	Exit out of cmap mode
(config)#class-map type qos match-any C_QOS4	Configure class-map C_QOS4 of type qos and enter into class-map mode
(config-cmap-qos)#match cos 3	Configure match criteria as cos 3
(config-cmap-qos)#match dscp 24-31	Configure match criteria as dscp 24-31
(config-cmap-qos)#exit	Exit out of cmap mode
(config)#class-map type qos match-any C_QOS5	Configure class-map C_QOS5 of type qos and enter into class-map mode
(config-cmap-qos)#match cos 4	Configure match criteria as cos 4
(config-cmap-qos)#match dscp 32-39	Configure match criteria as dscp 32-39

Hierarchical Queuing Configuration

<code>(config-cmap-qos)#exit</code>	Exit out of cmap mode
<code>(config)#class-map type qos match-any C_QOS6</code>	Configure class-map C_QOS6 of type qos and enter into class-map mode
<code>(config-cmap-qos)#match cos 5</code>	Configure match criteria as cos 5
<code>(config-cmap-qos)#match dscp 40-47</code>	Configure match criteria as dscp 40-47
<code>(config-cmap-qos)#exit</code>	Exit out of cmap mode
<code>(config)#class-map type qos match-any C_QOS7</code>	Configure class-map C_QOS7 of type qos and enter into class-map mode
<code>(config-cmap-qos)#match cos 6</code>	Configure match criteria as cos 6
<code>(config-cmap-qos)#match dscp 48-55</code>	Configure match criteria as dscp 48-55
<code>(config-cmap-qos)#exit</code>	Exit out of cmap mode
<code>(config)#class-map type qos match-any C_QOS8</code>	Configure class-map C_QOS8 of type qos and enter into class-map mode
<code>(config-cmap-qos)#match cos 7</code>	Configure match criteria as cos 7
<code>(config-cmap-qos)#match dscp 56-63</code>	Configure match criteria as dscp 56-63
<code>(config-cmap-qos)#exit</code>	Exit out of cmap mode
<code>(config)#class-map type queuing match-any cq1</code>	Configure class-map cq1 of type queuing and enter into class-map mode.
<code>(config-cmap-que)#match qos-group 1</code>	Configure match criteria as qos-group 1
<code>(config-cmap-que)#exit</code>	Exit out of cmap mode.
<code>(config)#class-map type queuing match-any cq2</code>	Configure class-map cq2 of type queuing and enter into class-map mode.
<code>(config-cmap-que)#match qos-group 2</code>	Configure match criteria as qos-group 2
<code>(config-cmap-que)#exit</code>	Exit out of cmap mode.
<code>(config)#class-map type queuing match-any cq3</code>	Configure class-map cq3 of type queuing and enter into class-map mode.
<code>(config-cmap-que)#match qos-group 3</code>	Configure match criteria as qos-group 3
<code>(config-cmap-que)#exit</code>	Exit out of cmap mode.
<code>(config)#class-map type queuing match-any cq4</code>	Configure class-map cq4 of type queuing and enter into class-map mode.
<code>(config-cmap-que)#match qos-group 4</code>	Configure match criteria as qos-group 4
<code>(config-cmap-que)#exit</code>	Exit out of cmap mode.
<code>(config)#class-map type queuing match-any cq5</code>	Configure class-map cq5 of type queuing and enter into class-map mode.
<code>(config-cmap-que)#match qos-group 5</code>	Configure match criteria as qos-group 5
<code>(config-cmap-que)#exit</code>	Exit out of cmap mode.
<code>(config)#class-map type queuing match-any cq6</code>	Configure class-map cq6 of type queuing and enter into class-map mode.
<code>(config-cmap-que)#match qos-group 6</code>	Configure match criteria as qos-group 6
<code>(config-cmap-que)#exit</code>	Exit out of cmap mode.
<code>(config)#class-map type queuing match-any cq7</code>	Configure class-map cq7 of type queuing and enter into class-map mode.
<code>(config-cmap-que)#match qos-group 7</code>	Configure match criteria as qos-group 7
<code>(config-cmap-que)#exit</code>	Exit out of cmap mode.

<code>(config)#class-map type queuing match-any cq8</code>	Configure class-map cq8 of type queuing and enter into class-map mode.
<code>(config-cmap-que)#match qos-group 8</code>	Configure match criteria as qos-group 8
<code>(config-cmap-que)#exit</code>	Exit out of cmap mode.
<code>(config)#policy-map type qos pmap1</code>	Configure policy-map pmap1 og type qos and enter into policy-map mode.
<code>(config-pmap-qos)#class type qos C_QOS1</code>	Assign class C-QOS1 to pmap1 and enter into policy-class-map mode.
<code>(config-pmap-c-qos)#set qos-group 1</code>	Remark matched traffic to qos-group 1
<code>(config-pmap-c-qos)#exit</code>	Exit out of policy-class-map mode
<code>(config-pmap-qos)#class type qos C_QOS2</code>	Assign class C-QOS2 to pmap1 and enter into policy-class-map mode.
<code>(config-pmap-c-qos)#set qos-group 2</code>	Remark matched traffic to qos-group 2
<code>(config-pmap-c-qos)#exit</code>	Exit out of policy-class-map mode
<code>(config-pmap-qos)#class type qos C_QOS3</code>	Assign class C-QOS3 to pmap1 and enter into policy-class-map mode.
<code>(config-pmap-c-qos)#set qos-group 3</code>	Remark matched traffic to qos-group 3
<code>(config-pmap-c-qos)#exit</code>	Exit out of policy-class-map mode
<code>(config-pmap-qos)#class type qos C_QOS4</code>	Assign class C-QOS4 to pmap1 and enter into policy-class-map mode.
<code>(config-pmap-c-qos)#set qos-group 4</code>	Remark matched traffic to qos-group 4
<code>(config-pmap-c-qos)#exit</code>	Exit out of policy-class-map mode
<code>(config-pmap-qos)#class type qos C_QOS5</code>	Assign class C-QOS5 to pmap1 and enter into policy-class-map mode.
<code>(config-pmap-c-qos)#set qos-group 5</code>	Remark matched traffic to qos-group 5
<code>(config-pmap-c-qos)#exit</code>	Exit out of policy-class-map mode
<code>(config-pmap-qos)#class type qos C_QOS6</code>	Assign class C-QOS6 to pmap1 and enter into policy-class-map mode.
<code>(config-pmap-c-qos)#set qos-group 6</code>	Remark matched traffic to qos-group 6
<code>(config-pmap-c-qos)#exit</code>	Exit out of policy-class-map mode
<code>(config-pmap-qos)#class type qos C_QOS7</code>	Assign class C-QOS7 to pmap1 and enter into policy-class-map mode.
<code>(config-pmap-c-qos)#set qos-group 7</code>	Remark matched traffic to qos-group 7
<code>(config-pmap-c-qos)#exit</code>	Exit out of policy-class-map mode
<code>(config-pmap-qos)#class type qos C_QOS8</code>	Assign class C-QOS8 to pmap1 and enter into policy-class-map mode.
<code>(config-pmap-c-qos)#set qos-group 8</code>	Remark matched traffic to qos-group 8
<code>(config-pmap-c-qos)#exit</code>	Exit out of policy-class-map mode
<code>(config-pmap-qos)#exit</code>	Exit out of policy-map mode
<code>(config)#policy-map type queuing P1P1</code>	Configure policy-map of type queuing P1P1 and enter into policy-map mode.
<code>(config-pmap-que)#class type queuing cq1</code>	Assign class cq1 to policy-map P1 and enter into policy-class-map mode.
<code>(config-pmap-c-que)#shape average percent 20</code>	Shape the matched traffic to percent 20
<code>(config-pmap-c-que)#queue-limit 70 packets</code>	Configure tail-drop on q1 to 70 packets.

Hierarchical Queuing Configuration

(config-pmap-c-que)#bandwidth percent 18	Configure minimum bandwidth to 18 percent on q1.
(config-pmap-c-que)#exit	Exit out of policy-class-map mode.
(config-pmap-que)#class type queuing cq2	Assign class cq2 to policy-map P1 and enter into policy-class-map mode.
(config-pmap-c-que)#shape average percent 80	Shape the matched traffic to percent 80
(config-pmap-c-que)#queue-limit 70 packets	Configure tail-drop on q2 to 70 packets.
(config-pmap-c-que)#bandwidth percent 75	Configure minimum bandwidth to 75 percent on q2.
(config-pmap-c-que)#exit	Exit out of policy-class-map mode.
(config-pmap-que)#exit	Exit out of policy-map mode.
(config)#policy-map type queuing P2	Configure policy-map of type queuing P2 and enter into policy-map mode.
(config-pmap-que)#class type queuing cq3	Assign class cq3 to policy-map P2 and enter into policy-class-map mode.
(config-pmap-c-que)#shape average percent 25	Shape the matched traffic to percent 25
(config-pmap-c-que)#random-detect min-threshold 50 max-threshold 75 kbytes	Configure WRED on q3 to minimum threshold 50 and maximum threshold 75 packets.
(config-pmap-c-que)#bandwidth percent 20	Configure minimum bandwidth to 20 percent on q3.
(config-pmap-c-que)#exit	Exit out of policy-class-map mode.
(config-pmap-que)#class type queuing cq4	Assign class cq4 to policy-map P2 and enter into policy-class-map mode.
(config-pmap-c-que)#shape average percent 75	Shape the matched traffic to percent 75
(config-pmap-c-que)#random-detect min-threshold 50 max-threshold 75 kbytes	Configure WRED on q4 to minimum threshold 50 and maximum threshold 75 kbytes.
(config-pmap-c-que)#bandwidth percent 65	Configure minimum bandwidth to 65 percent on q4.
(config-pmap-c-que)#exit	Exit out of policy-class-map mode.
(config-pmap-que)#exit	Exit out of policy-map mode.
(config)#policy-map type queuing P3	Configure policy-map of type queuing P3 and enter into policy-map mode.
(config-pmap-que)#class type queuing cq5	Assign class cq5 to policy-map P3 and enter into policy-class-map mode.
(config-pmap-c-que)#shape average percent 40	Shape the matched traffic to percent 40
(config-pmap-c-que)#queue-limit 100 packets	Configure Tail-Drop on q5 to 100 packets.
(config-pmap-c-que)#bandwidth percent 35	Configure minimum bandwidth to 35 percent on q5.
(config-pmap-c-que)#exit	Exit out of policy-class-map mode.
(config-pmap-que)#class type queuing cq6	Assign class cq6 to policy-map P3 and enter into policy-class-map mode.
(config-pmap-c-que)#shape average percent 60	Shape the matched traffic to percent 60
(config-pmap-c-que)#queue-limit 100 packets	Configure Tail-Drop on q6 to 100 packets.
(config-pmap-c-que)#bandwidth percent 55	Configure minimum bandwidth to 55 percent on q6.
(config-pmap-c-que)#exit	Exit out of policy-class-map mode.
(config-pmap-que)#exit	Exit out of policy-map mode.
(config)#policy-map type queuing P4	Configure policy-map of type queuing P4 and enter into policy-map mode.
(config-pmap-que)#class type queuing cq7	Assign class cq7 to policy-map P4 and enter into policy-class-map mode.

<code>(config-pmap-c-que)#shape average percent 40</code>	Shape the matched traffic to percent 40
<code>(config-pmap-c-que)#random-detect min-threshold 80 packets max-threshold 100 packets</code>	Configure WRED on q7 to maximum threshold of 80 packets and maximum threshold of 100 packets..
<code>(config-pmap-c-que)#bandwidth percent 35</code>	Configure minimum bandwidth to 35 percent on q7.
<code>(config-pmap-c-que)#exit</code>	Exit out of policy-class-map mode.
<code>(config-pmap-que)#class type queuing cq8</code>	Assign class cq8 to policy-map P4 and enter into policy-class-map mode.
<code>(config-pmap-c-que)#shape average percent 60</code>	Shape the matched traffic to percent 60
<code>(config-pmap-c-que)#random-detect min-threshold 80 packets max-threshold 100 packets</code>	Configure WRED on q8 to minimum threshold of 80 packets and maximum threshold of 100 packets..
<code>(config-pmap-c-que)#bandwidth percent 55</code>	Configure minimum bandwidth to 55 percent on q8.
<code>(config-pmap-c-que)#exit</code>	Exit out of policy-class-map mode.
<code>(config-pmap-que)#exit</code>	Exit out of policy-map mode.
<code>(config)#class-map type queuing match-any empty1</code>	Configure class-map of type queuing empty1
<code>(config-cmap-que)#exit</code>	Exit out of cmap mode
<code>(config)#class-map type queuing match-any empty2</code>	Configure class-map of type queuing empty2
<code>(config-cmap-que)#exit</code>	Exit out of cmap mode
<code>(config)#class-map type queuing match-any empty3</code>	Configure class-map of type queuing empty3
<code>(config-cmap-que)#exit</code>	Exit out of cmap mode
<code>(config)#class-map type queuing match-any empty4</code>	Configure class-map of type queuing empty4
<code>(config-cmap-que)#exit</code>	Exit out of cmap mode
<code>(config)#class-map type queuing match-any empty5</code>	Configure class-map of type queuing empty5
<code>(config-cmap-que)#exit</code>	Exit out of cmap mode
<code>(config)#class-map type queuing match-any empty6</code>	Configure class-map of type queuing empty6
<code>(config-cmap-que)#exit</code>	Exit out of cmap mode
<code>(config)#policy-map type queuing P1P2</code>	Configure policy-map of type queuing P1P2 and enter into policy-map mode.
<code>(config-pmap-que)#class type queuing empty1</code>	Assign class-map of type queuing empty1 to P1P2 and enter into policy-class-map mode.
<code>(config-pmap-c-que)#shape average percent 40</code>	Shape the matched traffic to 40 percent
<code>(config-pmap-c-que)#bandwidth percent 30</code>	Configure minimum bandwidth to 30 percent on empty1.
<code>(config-pmap-c-que)#service-policy P1P1</code>	Assign service-policy P1P1
<code>(config-pmap-c-que)#exit</code>	Exit out of policy-class-map mode.
<code>(config-pmap-que)#class type queuing empty2</code>	Assign class-map of type queuing empty2 to P1P2 and enter into policy-class-map mode.
<code>(config-pmap-c-que)#shape average percent 60</code>	Shape the matched traffic to 60 percent
<code>(config-pmap-c-que)#bandwidth percent 55</code>	Configure minimum bandwidth to 55 percent on empty2.
<code>(config-pmap-c-que)#service-policy P2</code>	Assign service-policy P2

Hierarchical Queuing Configuration

<code>(config-pmap-c-que)#exit</code>	Exit out of policy-class-map mode.
<code>(config-pmap-que)#exit</code>	Exit out of policy-map mode.
<code>(config)#policy-map type queuing P3P4</code>	Configure policy-map of type queuing P3P4 and enter into policy-map mode.
<code>(config-pmap-que)#class type queuing empty3</code>	Assign class-map of type queuing empty3 to P3P4 and enter into policy-class-map mode.
<code>(config-pmap-c-que)#shape average percent 40</code>	Shape the matched traffic to 40 percent
<code>(config-pmap-c-que)#bandwidth percent 35</code>	Configure minimum bandwidth to 35 percent on empty3.
<code>(config-pmap-c-que)#service-policy P3</code>	Assign service-policy P3
<code>(config-pmap-c-que)#exit</code>	Exit out of policy-class-map mode.
<code>(config-pmap-que)#class type queuing empty4</code>	Assign class-map of type queuing empty4 to P3P4 and enter into policy-class-map mode.
<code>(config-pmap-c-que)#shape average percent 60</code>	Shape the matched traffic to 60 percent
<code>(config-pmap-c-que)#bandwidth percent 50</code>	Configure minimum bandwidth to 50 percent on empty4.
<code>(config-pmap-c-que)#service-policy P4</code>	Assign service-policy P4
<code>(config-pmap-c-que)#exit</code>	Exit out of policy-class-map mode.
<code>(config-pmap-que)#exit</code>	Exit out of policy-map mode.
<code>(config)#policy-map type queuing Pend</code>	Configure policy-map of type queuing Pend and enter into policy-map mode.
<code>(config-pmap-que)#class type queuing empty5</code>	Assign class-map of type queuing empty5 to Pend and enter into policy-class-map mode.
<code>(config-pmap-c-que)#shape average 400 mbps</code>	Shape the matched traffic to 400 mbps
<code>(config-pmap-c-que)#bandwidth 350 mbps</code>	Configure minimum bandwidth to 350 mbps.
<code>(config-pmap-c-que)#service-policy P1P1</code>	Assign service-policy P1P1
<code>(config-pmap-c-que)#exit</code>	Exit out of policy-class-map mode.
<code>(config-pmap-que)#class type queuing empty6</code>	Assign class-map of type queuing empty6 to Pend and enter into policy-class-map mode.
<code>(config-pmap-c-que)#shape average 500 mbps</code>	Shape the matched traffic to 500 mbps
<code>(config-pmap-c-que)#bandwidth 450 mbps</code>	Configure minimum bandwidth to 450 mbps.
<code>(config-pmap-c-que)#service-policy P3P4</code>	Assign service-policy P3P4
<code>(config-pmap-c-que)#exit</code>	Exit out of policy-class-map mode.
<code>(config-pmap-que)#exit</code>	Exit out of policy-map mode.
<code>(config)#interface xe2</code>	Enter into interface mode
<code>(config-if)#service-policy type qos input pmap1</code>	Assign service-policy of type qos policy-map1.
<code>(config-if)#exit</code>	Exit out of intf mode
<code>(config)#interface xe3</code>	Enter into interface mode
<code>(config-if)#service-policy type queuing output Pend</code>	Assign service-policy of type queuing pend on out direction.
<code>(config-if)#exit</code>	Exit out of interface mode.
Configuring one of the scheduler modes implicitly un-configures other modes, only one scheduler mode can be configured at a time.	
<code>(config)#set qos wrr uc 1 non-uc 2</code>	Schedule unicast and multicast traffic in 1:2

(config)#set qos sp	Set strict priority between unicast and multicast traffic, with higher priority to multicast traffic
(config)#interface xe49/2	Enter interface mode
(config-if)#exit	Exit interface mode
(config)#bridge 1 protocol rstp vlan-bridge	Specify VLAN for bridge 1.
(config)#vlan database	Enter the VLAN configuration mode.
(config-vlan)#vlan 2-3 bridge 1 state enable	Enable VLAN (2-3) on bridge 1. Specifying the enable state.
(config-vlan)#exit	Exit the VLAN configuration mode.
(config)#interface vlan1.2	Enter interface mode.
(config-if)# ip address 10.1.1.2/24	Configure the IP address.
(config-if)#exit	Exit the interface mode.
(config)#interface vlan1.3	Enter interface mode.
(config-if)# ip address 20.1.1.1/24	Configure the IP address.
(config-if)#exit	Exit the interface mode.
(config)#interface xe2	Enter interface mode.
(config-if)#switchport	Configure xe2 as a Layer 2 port.
(config-if)#bridge-group 1	Associate the interface with bridge group 1.
(config-if)#switchport mode trunk	Configure port as a trunk.
(config-if)#switchport trunk allowed vlan all	Allow all the VLANs on the xe3 interface.
(config-if)#exit	Exit the interface mode.
(config)#interface xe3	Enter interface mode.
(config-if)#switchport	Configure xe3 as a Layer 2 port.
(config-if)#bridge-group 1	Associate the interface with bridge group 1.
(config-if)#switchport mode trunk	Configure port as a trunk.
(config-if)#switchport trunk allowed vlan all	Allow all the VLANs on the xe3 interface.
(config-if)#exit	Exit the interface mode.

Validation

Enter the commands listed in the sections below to confirm the configurations.

```
#show running-config qos
qos enable
!
set qos wrp uc 1 non-uc 2
qos statistics
!
class-map type qos match-any C_QOS1
  match dscp 0-7
  match cos 0
!
class-map type qos match-any C_QOS2
  match dscp 8-15
  match cos 1
```

Hierarchical Queuing Configuration

```
!  
class-map type qos match-any C_QOS3  
  match dscp 16-23  
  match cos 2  
!  
class-map type qos match-any C_QOS4  
  match dscp 24-31  
  match cos 3  
!  
class-map type qos match-any C_QOS5  
  match dscp 32-39  
  match cos 4  
!  
class-map type qos match-any C_QOS6  
  match dscp 40-47  
  match cos 5  
!  
class-map type qos match-any C_QOS7  
  match dscp 48-55  
  match cos 6  
!  
class-map type qos match-any C_QOS8  
  match dscp 56-63  
  match cos 7  
!  
class-map type queuing match-any cq1  
  match qos-group 1  
!  
class-map type queuing match-any cq2  
  match qos-group 2  
!  
class-map type queuing match-any cq3  
  match qos-group 3  
!  
class-map type queuing match-any cq4  
  match qos-group 4  
!  
class-map type queuing match-any cq5  
!  
class-map type queuing match-any cq6  
  match qos-group 6  
!  
class-map type queuing match-any cq7  
  match qos-group 7  
!  
class-map type queuing match-any cq8  
  match qos-group 8  
!  
class-map type queuing match-any empty1  
!  
!
```

```
class-map type queuing match-any empty2
!
class-map type queuing match-any empty3
!
class-map type queuing match-any empty4
!
class-map type queuing match-any empty5
!
class-map type queuing match-any empty6
!
policy-map type qos pmap1
  class type qos C_QOS1
    set qos-group 1
    exit
  class type qos C_QOS2
    set qos-group 2
    exit
  class type qos C_QOS3
    set qos-group 3
    exit
  class type qos C_QOS4
    set qos-group 4
    exit
  class type qos C_QOS5
    set qos-group 5
    exit
  class type qos C_QOS6
    set qos-group 6
    exit
  class type qos C_QOS7
    set qos-group 7
    exit
  class type qos C_QOS8
    set qos-group 8
    exit
!
policy-map type queuing P1P1
  class type queuing cq1
    shape average percent 20
    wrr-queue weight 1
    queue-limit 70 packets
    bandwidth percent 18
    exit
  class type queuing cq2
    shape average percent 80
    wrr-queue weight 1
    queue-limit 70 packets
    bandwidth percent 75
    exit
!
```

Hierarchical Queuing Configuration

```
policy-map type queuing P2
  class type queuing cq3
    shape average percent 25
    wrr-queue weight 1
    random-detect min-threshold 50 max-threshold 75 kbytes
    bandwidth percent 20
  exit
  class type queuing cq4
    shape average percent 75
    wrr-queue weight 1
    random-detect min-threshold 50 max-threshold 75 kbytes
    bandwidth percent 65
  exit
!
policy-map type queuing P3
  class type queuing cq5
    shape average percent 40
    wrr-queue weight 1
    queue-limit 100 packets
    bandwidth percent 35
  exit
  class type queuing cq6
    shape average percent 60
    wrr-queue weight 1
    queue-limit 100 packets
    bandwidth percent 55
  exit
!
policy-map type queuing P4
  class type queuing cq7
    shape average percent 40
    wrr-queue weight 1
    random-detect min-threshold 80 max-threshold 100 packets
    bandwidth percent 35
  exit
  class type queuing cq8
    shape average percent 60
    wrr-queue weight 1
    random-detect min-threshold 80 max-threshold 100 packets
    bandwidth percent 55
  exit
!
!
policy-map type queuing P3P4
  class type queuing empty3
    shape average percent 40
    wrr-queue weight 1
    bandwidth percent 35
    service-policy P3
  exit
```



```
class type queuing empty4
  shape average percent 60
  wrr-queue weight 1
  bandwidth percent 50
  service-policy P4
  exit
!
policy-map type queuing P1P2
  class type queuing empty1
    shape average percent 40
    wrr-queue weight 1
    bandwidth percent 30
    service-policy P1P1
    exit
  class type queuing empty2
    shape average percent 60
    wrr-queue weight 1
    bandwidth percent 55
    service-policy P2
    exit
!
policy-map type queuing Pend
  class type queuing empty5
    shape average 400 mbps
    wrr-queue weight 1
    bandwidth 350 mbps
    service-policy P1P1
    exit
  class type queuing empty6
    shape average 500 mbps
    wrr-queue weight 1
    bandwidth 450 mbps
    service-policy P3P4
    exit
!
!
interface xe2
  service-policy type qos input pmap1
!
interface xe3
  service-policy type queuing output Pend
!

#sh class-map

Type qos class-maps
=====
      class-map type qos match-any C_QOS1
```

```
    match cos 0
    match dscp 0-7

class-map type qos match-any C_QOS2
    match cos 1
    match dscp 8-15

class-map type qos match-any C_QOS3
    match cos 2
    match dscp 16-23

class-map type qos match-any C_QOS4
    match cos 3
    match dscp 24-31

class-map type qos match-any C_QOS5
    match cos 4
    match dscp 32-39

class-map type qos match-any C_QOS6
    match cos 5
    match dscp 40-47

class-map type qos match-any C_QOS7
    match cos 6
    match dscp 48-55

class-map type qos match-any C_QOS8
    match cos 7
    match dscp 56-63

class-map type qos match-any class-default
```

Type queuing class-maps

=====

```
class-map type queuing match-any cq1
    match qos-group 1

class-map type queuing match-any cq2
    match qos-group 2

class-map type queuing match-any cq3
    match qos-group 3

class-map type queuing match-any cq4
    match qos-group 4

class-map type queuing match-any cq5
```

```
class-map type queuing match-any cq6
  match qos-group 6

class-map type queuing match-any cq7
  match qos-group 7

class-map type queuing match-any cq8
  match qos-group 8

class-map type queuing match-any empty1

class-map type queuing match-any empty2

class-map type queuing match-any empty3

class-map type queuing match-any empty4

class-map type queuing match-any empty5

class-map type queuing match-any empty6

class-map match-any q0

class-map match-any q1

class-map match-any q2

class-map match-any q3

class-map match-any q4

class-map match-any q5

class-map match-any q6

class-map match-any q7
```

```
Type Vlan-Queuing class-maps
=====
```

```
#show policy-map
```

```
Type qos policy-maps
=====
```

```
policy-map type qos pmap1
  class type qos C_QOS1
  set qos-group 1
  exit
```

Hierarchical Queuing Configuration

```
class type qos C_QOS2
  set qos-group 2
  exit
class type qos C_QOS3
  set qos-group 3
  exit
class type qos C_QOS4
  set qos-group 4
  exit
class type qos C_QOS5
  set qos-group 5
  exit
class type qos C_QOS6
  set qos-group 6
  exit
class type qos C_QOS7
  set qos-group 7
  exit
class type qos C_QOS8
  set qos-group 8
  exit
```

Type queuing policy-maps
=====

```
policy-map type queuing P1P1
  class type queuing cq1
    shape average percent 20
    wrr-queue weight 1
    queue-limit 70 packets
    bandwidth percent 18
    exit
  class type queuing cq2
    shape average percent 80
    wrr-queue weight 1
    queue-limit 70 packets
    bandwidth percent 75
    exit

policy-map type queuing P1P2
  class type queuing empty1
    shape average percent 40
    wrr-queue weight 1
    bandwidth percent 30
    service-policy P1P1
    exit
  class type queuing empty2
    shape average percent 60
    wrr-queue weight 1
```

```
bandwidth percent 55
service-policy P2
exit

policy-map type queuing P2
class type queuing cq3
  shape average percent 25
  wrr-queue weight 1
  random-detect min-threshold 50 max-threshold 75 kbytes
  bandwidth percent 20
  exit
class type queuing cq4
  shape average percent 75
  wrr-queue weight 1
  random-detect min-threshold 50 max-threshold 75 kbytes
  bandwidth percent 65
  exit

policy-map type queuing P3
class type queuing cq5
  shape average percent 40
  wrr-queue weight 1
  queue-limit 100 packets
  bandwidth percent 35
  exit
class type queuing cq6
  shape average percent 60
  wrr-queue weight 1
  queue-limit 100 packets
  bandwidth percent 55
  exit

policy-map type queuing P3P4
class type queuing empty3
  shape average percent 40
  wrr-queue weight 1
  bandwidth percent 35
  service-policy P3
  exit
class type queuing empty4
  shape average percent 60
  wrr-queue weight 1
  bandwidth percent 50
  service-policy P4
  exit

policy-map type queuing P4
class type queuing cq7
  shape average percent 40
  wrr-queue weight 1
```

Hierarchical Queuing Configuration

```
random-detect min-threshold 80 max-threshold 100 packets
bandwidth percent 35
exit
class type queuing cq8
shape average percent 60
wrr-queue weight 1
random-detect min-threshold 80 max-threshold 100 packets
bandwidth percent 55
exit

policy-map type queuing Pend
class type queuing empty5
shape average 400 mbps
wrr-queue weight 1
bandwidth 350 mbps
service-policy P1P1
exit
class type queuing empty6
shape average 500 mbps
wrr-queue weight 1
bandwidth 450 mbps
service-policy P3P4
exit

policy-map type queuing default default-out-policy
class type queuing default q0
priority level 1
exit
class type queuing default q1
priority level 1
exit
class type queuing default q2
priority level 1
exit
class type queuing default q3
priority level 1
exit
class type queuing default q4
priority level 1
exit
class type queuing default q5
priority level 1
exit
class type queuing default q6
priority level 1
exit
class type queuing default q7
priority level 1
exit
```

```
#show policy-map interface xe2

Interface xe2
Global statistics status : enabled

Service-policy (qos) input      : pmap1
-----
Class-map (qos): C_QOS1 (match any)
  match dscp 0-7
  match cos 0
  set qos-group 1
    matched      : 2 packets, 128 bytes
    transmitted  : 2 packets, 128 bytes

Class-map (qos): C_QOS2 (match any)
  match dscp 8-15
  match cos 1
  set qos-group 2
    matched      : 23751790 packets, 1520114560 bytes
    transmitted  : 23751790 packets, 1520114560 bytes

Class-map (qos): C_QOS3 (match any)
  match dscp 16-23
  match cos 2
  set qos-group 3
    matched      : 5412521 packets, 346401344 bytes
    transmitted  : 5412521 packets, 346401344 bytes

Class-map (qos): C_QOS4 (match any)
  match dscp 24-31
  match cos 3
  set qos-group 4
    matched      : 0 packets, 0 bytes
    transmitted  : 0 packets, 0 bytes

Class-map (qos): C_QOS5 (match any)
  match dscp 32-39
  match cos 4
  set qos-group 5
    matched      : 0 packets, 0 bytes
    transmitted  : 0 packets, 0 bytes

Class-map (qos): C_QOS6 (match any)
  match dscp 40-47
  match cos 5
  set qos-group 6
    matched      : 0 packets, 0 bytes
    transmitted  : 0 packets, 0 bytes
```

Hierarchical Queuing Configuration

```
Class-map (qos): C_QOS7 (match any)
  match dscp 48-55
  match cos 6
  set qos-group 7
    matched      : 0 packets, 0 bytes
    transmitted  : 0 packets, 0 bytes
```

```
Class-map (qos): C_QOS8 (match any)
  match dscp 56-63
  match cos 7
  set qos-group 8
    matched      : 0 packets, 0 bytes
    transmitted  : 0 packets, 0 bytes
```

Service-policy (queuing) output: default-out-policy

```
-----
Class-map (queuing): q0
  priority level 1
    output      : 0 packets, 0 bytes
    dropped     : 0 packets, 0 bytes
```

```
Class-map (queuing): q1
  priority level 1
    output      : 1 packets, 64 bytes
    dropped     : 0 packets, 0 bytes
```

```
Class-map (queuing): q2
  priority level 1
    output      : 0 packets, 0 bytes
    dropped     : 0 packets, 0 bytes
```

```
Class-map (queuing): q3
  priority level 1
    output      : 0 packets, 0 bytes
    dropped     : 0 packets, 0 bytes
```

```
Class-map (queuing): q4
  priority level 1
    output      : 0 packets, 0 bytes
    dropped     : 0 packets, 0 bytes
```

```
Class-map (queuing): q5
  priority level 1
    output      : 0 packets, 0 bytes
    dropped     : 0 packets, 0 bytes
```

```
Class-map (queuing): q6
  priority level 1
    output      : 0 packets, 0 bytes
```

```
    dropped      : 0 packets, 0 bytes

Class-map (queuing): q7
  priority level 1
    output       : 2058 packets, 131912 bytes
    dropped      : 0 packets, 0 bytes

Class-map (queuing): mc-q0
  output       : 0 packets, 0 bytes
  dropped      : 0 packets, 0 bytes

Class-map (queuing): mc-q1
  output       : 0 packets, 0 bytes
  dropped      : 0 packets, 0 bytes

Class-map (queuing): mc-q2
  output       : 0 packets, 0 bytes
  dropped      : 0 packets, 0 bytes

Class-map (queuing): mc-q3
  output       : 0 packets, 0 bytes
  dropped      : 0 packets, 0 bytes

Class-map (queuing): mc-q4
  output       : 0 packets, 0 bytes
  dropped      : 0 packets, 0 bytes

Class-map (queuing): mc-q5
  output       : 0 packets, 0 bytes
  dropped      : 0 packets, 0 bytes

Class-map (queuing): mc-q6
  output       : 0 packets, 0 bytes
  dropped      : 0 packets, 0 bytes

Class-map (queuing): mc-q7
  output       : 4 packets, 272 bytes
  dropped      : 0 packets, 0 bytes

Wred Drop Statistics :
-----
green  : 0 packets
yellow : 0 packets
red    : 0 packets

#show policy-map interface xe3

Interface xe3
Global statistics status : enabled
```

Hierarchical Queuing Configuration

Service-policy (queuing) output: Pend

```
Class-map (queuing): empty5
  shape average 400 mbps
  wrr-queue weight 1
  bandwidth 350 mbps
```

Service-policy (queuing) output: P1P1

```
Class-map (queuing): cq1
  match qos-group 1
  shape percent 20
wrr-queue weight 1
  queue-limit 70 packets
  bandwidth percent 18
      output      : 1 packets, 64 bytes
      dropped     : 0 packets, 0 bytes
```

```
Class-map (queuing): cq2
  match qos-group 2
  shape percent 80
wrr-queue weight 1
  queue-limit 70 packets
  bandwidth percent 75
      output      : 10290336 packets, 658581504 bytes
      dropped     : 13382099 packets, 856454336 bytes
```

```
Class-map (queuing): empty6
  shape average 500 mbps
  wrr-queue weight 1
  bandwidth 450 mbps
```

Service-policy (queuing) output: P3P4

```
Class-map (queuing): empty3
  shape percent 40
wrr-queue weight 1
  bandwidth percent 35
```

Service-policy (queuing) output: P3

```
Class-map (queuing): cq5
  shape percent 40
wrr-queue weight 1
  queue-limit 100 packets
  bandwidth percent 35
      output      : 0 packets, 0 bytes
      dropped     : 0 packets, 0 bytes
```

```
Class-map (queuing): cq6
  match qos-group 6
  shape percent 60
wrr-queue weight 1
  queue-limit 100 packets
  bandwidth percent 55
    output      : 0 packets, 0 bytes
    dropped     : 0 packets, 0 bytes

Class-map (queuing): empty4
  shape percent 60
wrr-queue weight 1
  bandwidth percent 50

Service-policy (queuing) output: P4
-----
Class-map (queuing): cq7
  match qos-group 7
  shape percent 40
wrr-queue weight 1
  random-detect min-threshold 80 max-threshold 100 packets
bytes
kbytes
percent
  bandwidth percent 35
    output      : 0 packets, 0 bytes
    dropped     : 0 packets, 0 bytes

Class-map (queuing): cq8
  match qos-group 8
  shape percent 60
wrr-queue weight 1
  random-detect min-threshold 80 max-threshold 100 packets
bytes
kbytes
percent
  bandwidth percent 55
    output      : 0 packets, 0 bytes
    dropped     : 0 packets, 0 bytes

Service-policy (queuing) output: default-out-policy
-----
Class-map (queuing): q0
  priority level 1
    output      : 0 packets, 0 bytes
    dropped     : 0 packets, 0 bytes

Class-map (queuing): q1
  priority level 1
    output      : 0 packets, 0 bytes
```

Hierarchical Queuing Configuration

dropped : 0 packets, 0 bytes

Class-map (queuing): q2

priority level 1

output : 0 packets, 0 bytes

dropped : 0 packets, 0 bytes

Class-map (queuing): q3

priority level 1

output : 0 packets, 0 bytes

dropped : 0 packets, 0 bytes

Class-map (queuing): q4

priority level 1

output : 0 packets, 0 bytes

dropped : 0 packets, 0 bytes

Class-map (queuing): q5

priority level 1

output : 0 packets, 0 bytes

dropped : 0 packets, 0 bytes

Class-map (queuing): q6

priority level 1

output : 0 packets, 0 bytes

dropped : 0 packets, 0 bytes

Class-map (queuing): q7

priority level 1

output : 2011 packets, 128964 bytes

dropped : 0 packets, 0 bytes

Class-map (queuing): mc-q0

output : 0 packets, 0 bytes

dropped : 0 packets, 0 bytes

Class-map (queuing): mc-q1

output : 0 packets, 0 bytes

dropped : 0 packets, 0 bytes

Class-map (queuing): mc-q2

output : 0 packets, 0 bytes

dropped : 0 packets, 0 bytes

Class-map (queuing): mc-q3

output : 0 packets, 0 bytes

dropped : 0 packets, 0 bytes

Class-map (queuing): mc-q4

output : 0 packets, 0 bytes

dropped : 0 packets, 0 bytes

Class-map (queuing): mc-q5
 output : 0 packets, 0 bytes
 dropped : 0 packets, 0 bytes

Class-map (queuing): mc-q6
 output : 0 packets, 0 bytes
 dropped : 0 packets, 0 bytes

Class-map (queuing): mc-q7
 output : 11 packets, 748 bytes
 dropped : 0 packets, 0 bytes

Wred Drop Statistics :

 green : 13382099 packets
 yellow : 0 packets
 red : 0 packets

#show queuing interface xe2

Egress Queuing for Ethernet xe2 [System]

L0	L1	L2	Group	PrioLevel	Shape
Bandwidth					
q0			-	High	-
-					
q1			-	High	-
-					
q2			-	High	-
-					
q3			-	High	-
-					
q4			-	High	-
-					
q5			-	High	-
-					
q6			-	High	-
-					
q7			-	High	-

#show queuing interface xe3

Egress Queuing for Ethernet xe3 [System]

L0	L1	L2	Group	PrioLevel	Shape
----	----	----	-------	-----------	-------

Hierarchical Queuing Configuration

Bandwidth				
empty5		-	-	400 mbps
350 mbps				
	cq1	1	-	20 percent
18 percent				
	cq2	2	-	80 percent
75 percent				
empty6		-	-	500 mbps
450 mbps				
	empty3	-	-	40 percent
35 percent				
	cq5	-	-	40 percent
35 percent				
	cq6	6	-	60 percent
55 percent				
	empty4	-	-	60 percent
50 percent				
	cq7	7	-	40 percent
35 percent				
	cq8	8	-	60 percent
55 percent				

```
(config)#set qos wrr uc 1 non-uc 127
(config)#exit
```

```
#show policy-map interface xe2
```

```
Interface xe2
Global statistics status : enabled
```

```
Service-policy (qos) input      : pmap1
```

```
-----
Class-map (qos): C_QOS1 (match any)
 match dscp 0-7
 match cos 0
 set qos-group 1
   matched      : 2 packets, 128 bytes
   transmitted  : 2 packets, 128 bytes
```

```
Class-map (qos): C_QOS2 (match any)
 match dscp 8-15
 match cos 1
 set qos-group 2
   matched      : 24126931 packets, 1544123584 bytes
   transmitted  : 24126931 packets, 1544123584 bytes
```

```
Class-map (qos): C_QOS3 (match any)
 match dscp 16-23
```

```
match cos 2
set qos-group 3
  matched      : 5412521 packets, 346401344 bytes
  transmitted  : 5412521 packets, 346401344 bytes
```

```
Class-map (qos): C_QOS4 (match any)
match dscp 24-31
match cos 3
set qos-group 4
  matched      : 0 packets, 0 bytes
  transmitted  : 0 packets, 0 bytes
```

```
Class-map (qos): C_QOS5 (match any)
match dscp 32-39
match cos 4
set qos-group 5
  matched      : 0 packets, 0 bytes
  transmitted  : 0 packets, 0 bytes
```

```
Class-map (qos): C_QOS6 (match any)
match dscp 40-47
match cos 5
set qos-group 6
  matched      : 0 packets, 0 bytes
  transmitted  : 0 packets, 0 bytes
```

```
Class-map (qos): C_QOS7 (match any)
match dscp 48-55
match cos 6
set qos-group 7
  matched      : 0 packets, 0 bytes
  transmitted  : 0 packets, 0 bytes
```

```
Class-map (qos): C_QOS8 (match any)
match dscp 56-63
match cos 7
set qos-group 8
  matched      : 0 packets, 0 bytes
  transmitted  : 0 packets, 0 bytes
```

```
Service-policy (queuing) output: default-out-policy
```

```
-----
Class-map (queuing): q0
priority level 1
  output      : 0 packets, 0 bytes
  dropped     : 0 packets, 0 bytes
```

```
Class-map (queuing): q1
priority level 1
```

Hierarchical Queuing Configuration

output : 1 packets, 64 bytes
dropped : 0 packets, 0 bytes

Class-map (queuing): q2

priority level 1

output : 0 packets, 0 bytes
dropped : 0 packets, 0 bytes

Class-map (queuing): q3

priority level 1

output : 0 packets, 0 bytes
dropped : 0 packets, 0 bytes

Class-map (queuing): q4

priority level 1

output : 0 packets, 0 bytes
dropped : 0 packets, 0 bytes

Class-map (queuing): q5

priority level 1

output : 0 packets, 0 bytes
dropped : 0 packets, 0 bytes

Class-map (queuing): q6

priority level 1

output : 0 packets, 0 bytes
dropped : 0 packets, 0 bytes

Class-map (queuing): q7

priority level 1

output : 2245 packets, 143880 bytes
dropped : 0 packets, 0 bytes

Class-map (queuing): mc-q0

output : 0 packets, 0 bytes
dropped : 0 packets, 0 bytes

Class-map (queuing): mc-q1

output : 0 packets, 0 bytes
dropped : 0 packets, 0 bytes

Class-map (queuing): mc-q2

output : 0 packets, 0 bytes
dropped : 0 packets, 0 bytes

Class-map (queuing): mc-q3

output : 0 packets, 0 bytes
dropped : 0 packets, 0 bytes

Class-map (queuing): mc-q4

```
output      : 0 packets, 0 bytes
dropped     : 0 packets, 0 bytes

Class-map (queuing): mc-q5
output      : 0 packets, 0 bytes
dropped     : 0 packets, 0 bytes

Class-map (queuing): mc-q6
output      : 0 packets, 0 bytes
dropped     : 0 packets, 0 bytes

Class-map (queuing): mc-q7
output      : 4 packets, 272 bytes
dropped     : 0 packets, 0 bytes

Wred Drop Statistics :
-----
green  : 0 packets
yellow : 0 packets
red    : 0 packets

#show policy-map interface xe3

Interface xe3
Global statistics status : enabled

Service-policy (queuing) output: Pend
-----
Class-map (queuing): empty5
shape average 400 mbps
wrr-queue weight 1
bandwidth 350 mbps

Service-policy (queuing) output: P1P1
-----
Class-map (queuing): cq1
match qos-group 1
shape percent 20
wrr-queue weight 1
queue-limit 70 packets
bandwidth percent 18
output      : 1 packets, 64 bytes
dropped     : 0 packets, 0 bytes

Class-map (queuing): cq2
match qos-group 2
shape percent 80
wrr-queue weight 1
queue-limit 70 packets
```

Hierarchical Queuing Configuration

```
bandwidth percent 75
  output      : 10761532 packets, 688738048 bytes
  dropped     : 13382100 packets, 856454400 bytes
```

```
Class-map (queuing): empty6
  shape average 500 mbps
  wrr-queue weight 1
  bandwidth 450 mbps
```

```
Service-policy (queuing) output: P3P4
-----
```

```
Class-map (queuing): empty3
  shape percent 40
wrr-queue weight 1
  bandwidth percent 35
```

```
Service-policy (queuing) output: P3
-----
```

```
Class-map (queuing): cq5
  shape percent 40
wrr-queue weight 1
  queue-limit 100 packets
  bandwidth percent 35
    output      : 0 packets, 0 bytes
    dropped     : 0 packets, 0 bytes
```

```
Class-map (queuing): cq6
  match qos-group 6
  shape percent 60
wrr-queue weight 1
  queue-limit 100 packets
  bandwidth percent 55
    output      : 0 packets, 0 bytes
    dropped     : 0 packets, 0 bytes
```

```
Class-map (queuing): empty4
  shape percent 60
wrr-queue weight 1
  bandwidth percent 50
```

```
Service-policy (queuing) output: P4
-----
```

```
Class-map (queuing): cq7
  match qos-group 7
  shape percent 40
wrr-queue weight 1
  random-detect min-threshold 80 max-threshold 100 packets
```

```
bytes
kbytes
percent
```

```
        bandwidth percent 35
            output          : 0 packets, 0 bytes
            dropped         : 0 packets, 0 bytes

        Class-map (queuing): cq8
            match qos-group 8
            shape percent 60
wrr-queue weight 1
            random-detect min-threshold 80 max-threshold 100 packets
bytes
kbytes
percent
        bandwidth percent 55
            output          : 0 packets, 0 bytes
            dropped         : 0 packets, 0 bytes

Service-policy (queuing) output: default-out-policy
-----
Class-map (queuing): q0
    priority level 1
        output          : 0 packets, 0 bytes
        dropped         : 0 packets, 0 bytes

Class-map (queuing): q1
    priority level 1
        output          : 0 packets, 0 bytes
        dropped         : 0 packets, 0 bytes

Class-map (queuing): q2
    priority level 1
        output          : 0 packets, 0 bytes
        dropped         : 0 packets, 0 bytes

Class-map (queuing): q3
    priority level 1
        output          : 0 packets, 0 bytes
        dropped         : 0 packets, 0 bytes

Class-map (queuing): q4
    priority level 1
        output          : 0 packets, 0 bytes
        dropped         : 0 packets, 0 bytes

Class-map (queuing): q5
    priority level 1
        output          : 0 packets, 0 bytes
        dropped         : 0 packets, 0 bytes

Class-map (queuing): q6
    priority level 1
```

Hierarchical Queuing Configuration

```
output      : 0 packets, 0 bytes
dropped     : 0 packets, 0 bytes
```

```
Class-map (queuing): q7
priority level 1
output      : 2246 packets, 144004 bytes
dropped     : 0 packets, 0 bytes
```

```
Class-map (queuing): mc-q0
output      : 0 packets, 0 bytes
dropped     : 0 packets, 0 bytes
```

```
Class-map (queuing): mc-q1
output      : 0 packets, 0 bytes
dropped     : 0 packets, 0 bytes
```

```
Class-map (queuing): mc-q2
output      : 0 packets, 0 bytes
dropped     : 0 packets, 0 bytes
```

```
Class-map (queuing): mc-q3
output      : 0 packets, 0 bytes
dropped     : 0 packets, 0 bytes
```

```
Class-map (queuing): mc-q4
output      : 0 packets, 0 bytes
dropped     : 0 packets, 0 bytes
```

```
Class-map (queuing): mc-q5
output      : 0 packets, 0 bytes
dropped     : 0 packets, 0 bytes
```

```
Class-map (queuing): mc-q6
output      : 0 packets, 0 bytes
dropped     : 0 packets, 0 bytes
```

```
Class-map (queuing): mc-q7
output      : 12 packets, 816 bytes
dropped     : 0 packets, 0 bytes
```

```
Wred Drop Statistics :
```

```
-----
green  : 13382099 packets
yellow : 0 packets
red    : 0 packets
```

```
(config)#set qos wrr uc 1 non-uc 2
(config)#exit
```

```
#show policy-map interface xe2

Interface xe2
Global statistics status : enabled

Service-policy (qos) input      : pmap1
-----
Class-map (qos): C_QOS1 (match any)
  match dscp 0-7
  match cos 0
  set qos-group 1
    matched      : 2 packets, 128 bytes
    transmitted  : 2 packets, 128 bytes

Class-map (qos): C_QOS2 (match any)
  match dscp 8-15
  match cos 1
  set qos-group 2
    matched      : 24459636 packets, 1565416704 bytes
    transmitted  : 24459636 packets, 1565416704 bytes

Class-map (qos): C_QOS3 (match any)
  match dscp 16-23
  match cos 2
  set qos-group 3
    matched      : 5412521 packets, 346401344 bytes
    transmitted  : 5412521 packets, 346401344 bytes

Class-map (qos): C_QOS4 (match any)
  match dscp 24-31
  match cos 3
  set qos-group 4
    matched      : 0 packets, 0 bytes
    transmitted  : 0 packets, 0 bytes

Class-map (qos): C_QOS5 (match any)
  match dscp 32-39
  match cos 4
  set qos-group 5
    matched      : 0 packets, 0 bytes
    transmitted  : 0 packets, 0 bytes

Class-map (qos): C_QOS6 (match any)
  match dscp 40-47
  match cos 5
  set qos-group 6
    matched      : 0 packets, 0 bytes
    transmitted  : 0 packets, 0 bytes

Class-map (qos): C_QOS7 (match any)
```

Hierarchical Queuing Configuration

```
match dscp 48-55
match cos 6
set qos-group 7
    matched      : 0 packets, 0 bytes
    transmitted  : 0 packets, 0 bytes

Class-map (qos): C_QOS8 (match any)
match dscp 56-63
match cos 7
set qos-group 8
    matched      : 0 packets, 0 bytes
    transmitted  : 0 packets, 0 bytes

Service-policy (queuing) output: default-out-policy
-----
Class-map (queuing): q0
priority level 1
    output       : 0 packets, 0 bytes
    dropped      : 0 packets, 0 bytes

Class-map (queuing): q1
priority level 1
    output       : 1 packets, 64 bytes
    dropped      : 0 packets, 0 bytes

Class-map (queuing): q2
priority level 1
    output       : 0 packets, 0 bytes
    dropped      : 0 packets, 0 bytes

Class-map (queuing): q3
priority level 1
    output       : 0 packets, 0 bytes
    dropped      : 0 packets, 0 bytes

Class-map (queuing): q4
priority level 1
    output       : 0 packets, 0 bytes
    dropped      : 0 packets, 0 bytes

Class-map (queuing): q5
priority level 1
    output       : 0 packets, 0 bytes
    dropped      : 0 packets, 0 bytes

Class-map (queuing): q6
priority level 1
    output       : 0 packets, 0 bytes
    dropped      : 0 packets, 0 bytes
```

```
Class-map (queuing): q7
  priority level 1
    output      : 2412 packets, 154568 bytes
    dropped     : 0 packets, 0 bytes
```

```
Class-map (queuing): mc-q0
  output      : 0 packets, 0 bytes
  dropped     : 0 packets, 0 bytes
```

```
Class-map (queuing): mc-q1
  output      : 0 packets, 0 bytes
  dropped     : 0 packets, 0 bytes
```

```
Class-map (queuing): mc-q2
  output      : 0 packets, 0 bytes
  dropped     : 0 packets, 0 bytes
```

```
Class-map (queuing): mc-q3
  output      : 0 packets, 0 bytes
  dropped     : 0 packets, 0 bytes
```

```
Class-map (queuing): mc-q4
  output      : 0 packets, 0 bytes
  dropped     : 0 packets, 0 bytes
```

```
Class-map (queuing): mc-q5
  output      : 0 packets, 0 bytes
  dropped     : 0 packets, 0 bytes
```

```
Class-map (queuing): mc-q6
  output      : 0 packets, 0 bytes
  dropped     : 0 packets, 0 bytes
```

```
Class-map (queuing): mc-q7
  output      : 4 packets, 272 bytes
  dropped     : 0 packets, 0 bytes
```

```
Wred Drop Statistics :
```

```
-----
green  : 0 packets
yellow : 0 packets
red    : 0 packets
```

```
#show policy-map interface xe3
```

```
Interface xe3
Global statistics status : enabled
```

Hierarchical Queuing Configuration

Service-policy (queuing) output: Pend

```
Class-map (queuing): empty5
  shape average 400 mbps
  wrr-queue weight 1
  bandwidth 350 mbps
```

Service-policy (queuing) output: P1P1

```
Class-map (queuing): cq1
  match qos-group 1
  shape percent 20
wrr-queue weight 1
  queue-limit 70 packets
  bandwidth percent 18
      output      : 1 packets, 64 bytes
      dropped     : 0 packets, 0 bytes
```

```
Class-map (queuing): cq2
  match qos-group 2
  shape percent 80
wrr-queue weight 1
  queue-limit 70 packets
  bandwidth percent 75
      output      : 10871860 packets, 695799040 bytes
      dropped     : 13598654 packets, 870313856 bytes
```

```
Class-map (queuing): empty6
  shape average 500 mbps
  wrr-queue weight 1
  bandwidth 450 mbps
```

Service-policy (queuing) output: P3P4

```
Class-map (queuing): empty3
  shape percent 40
wrr-queue weight 1
  bandwidth percent 35
```

Service-policy (queuing) output: P3

```
Class-map (queuing): cq5
  shape percent 40
wrr-queue weight 1
  queue-limit 100 packets
  bandwidth percent 35
      output      : 0 packets, 0 bytes
      dropped     : 0 packets, 0 bytes
```

```
Class-map (queuing): cq6
```

```
        match qos-group 6
        shape percent 60
wrr-queue weight 1
        queue-limit 100 packets
        bandwidth percent 55
                output      : 0 packets, 0 bytes
                dropped     : 0 packets, 0 bytes

Class-map (queuing): empty4
        shape percent 60
wrr-queue weight 1
        bandwidth percent 50

Service-policy (queuing) output: P4
-----
Class-map (queuing): cq7
        match qos-group 7
        shape percent 40
wrr-queue weight 1
        random-detect min-threshold 80 max-threshold 100 packets
bytes
kbytes
percent
        bandwidth percent 35
                output      : 0 packets, 0 bytes
                dropped     : 0 packets, 0 bytes

Class-map (queuing): cq8
        match qos-group 8
        shape percent 60
wrr-queue weight 1
        random-detect min-threshold 80 max-threshold 100 packets
bytes
kbytes
percent
        bandwidth percent 55
                output      : 0 packets, 0 bytes
                dropped     : 0 packets, 0 bytes

Service-policy (queuing) output: default-out-policy
-----
Class-map (queuing): q0
        priority level 1
                output      : 0 packets, 0 bytes
                dropped     : 0 packets, 0 bytes

Class-map (queuing): q1
        priority level 1
                output      : 0 packets, 0 bytes
                dropped     : 0 packets, 0 bytes
```

Hierarchical Queuing Configuration

```
Class-map (queuing): q2
  priority level 1
    output      : 0 packets, 0 bytes
    dropped     : 0 packets, 0 bytes

Class-map (queuing): q3
  priority level 1
    output      : 0 packets, 0 bytes
    dropped     : 0 packets, 0 bytes

Class-map (queuing): q4
  priority level 1
    output      : 0 packets, 0 bytes
    dropped     : 0 packets, 0 bytes

Class-map (queuing): q5
  priority level 1
    output      : 0 packets, 0 bytes
    dropped     : 0 packets, 0 bytes

Class-map (queuing): q6
  priority level 1
    output      : 0 packets, 0 bytes
    dropped     : 0 packets, 0 bytes

Class-map (queuing): q7
  priority level 1
    output      : 2410 packets, 154500 bytes
    dropped     : 0 packets, 0 bytes

Class-map (queuing): mc-q0
  output      : 0 packets, 0 bytes
  dropped     : 0 packets, 0 bytes

Class-map (queuing): mc-q1
  output      : 0 packets, 0 bytes
  dropped     : 0 packets, 0 bytes

Class-map (queuing): mc-q2
  output      : 0 packets, 0 bytes
  dropped     : 0 packets, 0 bytes

Class-map (queuing): mc-q3
  output      : 0 packets, 0 bytes
  dropped     : 0 packets, 0 bytes

Class-map (queuing): mc-q4
  output      : 0 packets, 0 bytes
  dropped     : 0 packets, 0 bytes
```

```
Class-map (queuing): mc-q5
  output      : 0 packets, 0 bytes
  dropped     : 0 packets, 0 bytes

Class-map (queuing): mc-q6
  output      : 0 packets, 0 bytes
  dropped     : 0 packets, 0 bytes

Class-map (queuing): mc-q7
  output      : 13 packets, 884 bytes
  dropped     : 0 packets, 0 bytes
```

```
Wred Drop Statistics :
```

```
-----
green  : 13598643 packets
yellow : 0 packets
red    : 0 packets
```

```
(config)#set qos sp
(config)#exit
```

```
#show policy-map interface xe2
```

```
Interface xe2
Global statistics status : enabled
```

```
Service-policy (qos) input      : pmap1
```

```
-----
Class-map (qos): C_QOS1 (match any)
  match dscp 0-7
  match cos 0
  set qos-group 1
    matched      : 2 packets, 128 bytes
    transmitted  : 2 packets, 128 bytes
```

```
Class-map (qos): C_QOS2 (match any)
  match dscp 8-15
  match cos 1
  set qos-group 2
    matched      : 24622849 packets, 1575862336 bytes
    transmitted  : 24622849 packets, 1575862336 bytes
```

```
Class-map (qos): C_QOS3 (match any)
  match dscp 16-23
  match cos 2
  set qos-group 3
    matched      : 5412521 packets, 346401344 bytes
```

Hierarchical Queuing Configuration

transmitted : 5412521 packets, 346401344 bytes

Class-map (qos): C_QOS4 (match any)
match dscp 24-31
match cos 3
set qos-group 4
 matched : 0 packets, 0 bytes
 transmitted : 0 packets, 0 bytes

Class-map (qos): C_QOS5 (match any)
match dscp 32-39
match cos 4
set qos-group 5
 matched : 0 packets, 0 bytes
 transmitted : 0 packets, 0 bytes

Class-map (qos): C_QOS6 (match any)
match dscp 40-47
match cos 5
set qos-group 6
 matched : 0 packets, 0 bytes
 transmitted : 0 packets, 0 bytes

Class-map (qos): C_QOS7 (match any)
match dscp 48-55
match cos 6
set qos-group 7
 matched : 0 packets, 0 bytes
 transmitted : 0 packets, 0 bytes

Class-map (qos): C_QOS8 (match any)
match dscp 56-63
match cos 7
set qos-group 8
 matched : 0 packets, 0 bytes
 transmitted : 0 packets, 0 bytes

Service-policy (queuing) output: default-out-policy

Class-map (queuing): q0
priority level 1
 output : 0 packets, 0 bytes
 dropped : 0 packets, 0 bytes

Class-map (queuing): q1
priority level 1
 output : 1 packets, 64 bytes
 dropped : 0 packets, 0 bytes

```
Class-map (queuing): q2
  priority level 1
    output      : 0 packets, 0 bytes
    dropped     : 0 packets, 0 bytes

Class-map (queuing): q3
  priority level 1
    output      : 0 packets, 0 bytes
    dropped     : 0 packets, 0 bytes

Class-map (queuing): q4
  priority level 1
    output      : 0 packets, 0 bytes
    dropped     : 0 packets, 0 bytes

Class-map (queuing): q5
  priority level 1
    output      : 0 packets, 0 bytes
    dropped     : 0 packets, 0 bytes

Class-map (queuing): q6
  priority level 1
    output      : 0 packets, 0 bytes
    dropped     : 0 packets, 0 bytes

Class-map (queuing): q7
  priority level 1
    output      : 2493 packets, 159752 bytes
    dropped     : 0 packets, 0 bytes

Class-map (queuing): mc-q0
  output      : 0 packets, 0 bytes
  dropped     : 0 packets, 0 bytes

Class-map (queuing): mc-q1
  output      : 0 packets, 0 bytes
  dropped     : 0 packets, 0 bytes

Class-map (queuing): mc-q2
  output      : 0 packets, 0 bytes
  dropped     : 0 packets, 0 bytes

Class-map (queuing): mc-q3
  output      : 0 packets, 0 bytes
  dropped     : 0 packets, 0 bytes

Class-map (queuing): mc-q4
  output      : 0 packets, 0 bytes
  dropped     : 0 packets, 0 bytes
```

Hierarchical Queuing Configuration

```
Class-map (queuing): mc-q5
  output      : 0 packets, 0 bytes
  dropped     : 0 packets, 0 bytes

Class-map (queuing): mc-q6
  output      : 0 packets, 0 bytes
  dropped     : 0 packets, 0 bytes

Class-map (queuing): mc-q7
  output      : 4 packets, 272 bytes
  dropped     : 0 packets, 0 bytes
```

Wred Drop Statistics :

```
-----
green  : 0 packets
yellow : 0 packets
red    : 0 packets
```

#show policy-map interface xe3

```
Interface xe3
Global statistics status : enabled
```

Service-policy (queuing) output: Pend

```
-----
Class-map (queuing): empty5
  shape average 400 mbps
  wrr-queue weight 1
  bandwidth 350 mbps
```

Service-policy (queuing) output: P1P1

```
-----
Class-map (queuing): cq1
  match qos-group 1
  shape percent 20
wrr-queue weight 1
  queue-limit 70 packets
  bandwidth percent 18
    output      : 1 packets, 64 bytes
    dropped     : 0 packets, 0 bytes
```

```
Class-map (queuing): cq2
  match qos-group 2
  shape percent 80
wrr-queue weight 1
  queue-limit 70 packets
  bandwidth percent 75
    output      : 10871860 packets, 695799040 bytes
    dropped     : 13743831 packets, 879605184 bytes
```

```
Class-map (queuing): empty6
  shape average 500 mbps
  wrr-queue weight 1
  bandwidth 450 mbps

  Service-policy (queuing) output: P3P4
  -----
  Class-map (queuing): empty3
    shape percent 40
  wrr-queue weight 1
    bandwidth percent 35

    Service-policy (queuing) output: P3
    -----
    Class-map (queuing): cq5
      shape percent 40
  wrr-queue weight 1
    queue-limit 100 packets
    bandwidth percent 35
      output      : 0 packets, 0 bytes
      dropped     : 0 packets, 0 bytes

    Class-map (queuing): cq6
      match qos-group 6
      shape percent 60
  wrr-queue weight 1
    queue-limit 100 packets
    bandwidth percent 55
      output      : 0 packets, 0 bytes
      dropped     : 0 packets, 0 bytes

    Class-map (queuing): empty4
      shape percent 60
  wrr-queue weight 1
    bandwidth percent 50

    Service-policy (queuing) output: P4
    -----
    Class-map (queuing): cq7
      match qos-group 7
      shape percent 40
  wrr-queue weight 1
    random-detect min-threshold 80 max-threshold 100 packets
  bytes
  kbytes
  percent
    bandwidth percent 35
      output      : 0 packets, 0 bytes
      dropped     : 0 packets, 0 bytes
```

Hierarchical Queuing Configuration

```
Class-map (queuing): cq8
  match qos-group 8
  shape percent 60
wrr-queue weight 1
  random-detect min-threshold 80 max-threshold 100 packets
bytes
kbytes
percent
  bandwidth percent 55
    output      : 0 packets, 0 bytes
    dropped     : 0 packets, 0 bytes
```

Service-policy (queuing) output: default-out-policy

```
-----
Class-map (queuing): q0
  priority level 1
    output      : 0 packets, 0 bytes
    dropped     : 0 packets, 0 bytes
```

```
Class-map (queuing): q1
  priority level 1
    output      : 0 packets, 0 bytes
    dropped     : 0 packets, 0 bytes
```

```
Class-map (queuing): q2
  priority level 1
    output      : 0 packets, 0 bytes
    dropped     : 0 packets, 0 bytes
```

```
Class-map (queuing): q3
  priority level 1
    output      : 0 packets, 0 bytes
    dropped     : 0 packets, 0 bytes
```

```
Class-map (queuing): q4
  priority level 1
    output      : 0 packets, 0 bytes
    dropped     : 0 packets, 0 bytes
```

```
Class-map (queuing): q5
  priority level 1
    output      : 0 packets, 0 bytes
    dropped     : 0 packets, 0 bytes
```

```
Class-map (queuing): q6
  priority level 1
    output      : 0 packets, 0 bytes
    dropped     : 0 packets, 0 bytes
```

```
Class-map (queuing): q7
  priority level 1
    output      : 2488 packets, 159492 bytes
    dropped     : 3 packets, 192 bytes

Class-map (queuing): mc-q0
  output      : 0 packets, 0 bytes
  dropped     : 0 packets, 0 bytes

Class-map (queuing): mc-q1
  output      : 0 packets, 0 bytes
  dropped     : 0 packets, 0 bytes

Class-map (queuing): mc-q2
  output      : 0 packets, 0 bytes
  dropped     : 0 packets, 0 bytes

Class-map (queuing): mc-q3
  output      : 0 packets, 0 bytes
  dropped     : 0 packets, 0 bytes

Class-map (queuing): mc-q4
  output      : 0 packets, 0 bytes
  dropped     : 0 packets, 0 bytes

Class-map (queuing): mc-q5
  output      : 0 packets, 0 bytes
  dropped     : 0 packets, 0 bytes

Class-map (queuing): mc-q6
  output      : 0 packets, 0 bytes
  dropped     : 0 packets, 0 bytes

Class-map (queuing): mc-q7
  output      : 13 packets, 884 bytes
  dropped     : 0 packets, 0 bytes
```

Wred Drop Statistics :

```
-----
green  : 13743818 packets
yellow : 0 packets
red    : 0 packets
```

CHAPTER 17 VXLAN Quality of Service

For VXLAN Quality-of-Service configuration procedures, see the [Virtual eXtensible Local Area Network Configuration Guide](#).

CHAPTER 18 FP Rules Queuing Configuration

This chapter contains basic information about cpu-queue properties and complete sample configuration for cpu-queue properties.

DUT has many CPU queues for management/classification of control traffic and provides rate limiters for control plane protection. Different types of CPU port bound packets are queued in different cpu-queues each with different properties like rate, queue-limit, monitoring status and drop status.

Topology



Figure 18-18: Simple configuration of CPU Queuing

Default Values

```

R1#show cpu-queue details
* - Can not configure the parameter

```

Cpu queue	Rate	In PPS	Lossy	Status	Monitor	Status
Name	Configured	Default	Configured	Default	Configured	Default
sflow	-	32000	-	*lossy	-	monitor
bgp	-	1500	-	lossless	-	monitor
vrrp	-	500	-	lossless	-	monitor
ldp-rsvp	-	500	-	lossless	-	monitor
rip	-	500	-	lossless	-	monitor
ospf	-	2000	-	lossless	-	monitor
dhcp	-	100	-	lossy	-	no-
monitor						
nd	-	6000	-	lossless	-	monitor
mpls	-	500	-	lossy	-	no-
monitor						
pim	-	4000	-	*lossy	-	*no-
monitor						
arp	-	6000	-	lossless	-	monitor
igmp	-	4000	-	*lossy	-	*no-
monitor						
bpdu	-	10000	-	lossless	-	monitor
ccm	-	500	-	lossy	-	no-
monitor						
bfd	-	2000	-	lossy	-	no-
monitor						
ptp	-	1000	-	lossy	-	no-
monitor						
isis	-	500	-	lossless	-	monitor
trill-isis	-	1000	-	lossless	-	monitor
acl	-	200	-	*lossy	-	*no-
monitor						
vxlan	-	500	-	lossy	-	monitor

Note: Enable feature before validating cpu-queue for that protocol.

Monitor option will generate operational log, if it reaches above 90%. Log generation will stop, when it goes below 90%.

1. 2001 Jan 07 22:29:03.345 : R1 : HSL : NOTIF : [CPU_RATE_HIGH_4]: Average CPU queue rate for bpdu is 90% (540 pkts/sec).
2. 2001 Jan 07 22:29:08.346 : R1 : HSL : NOTIF : [CPU_QUEUE_RECOVERED_4]: CPU queue rate for bpdu is back to normal. Current average rate is 89%.

Lossless option will drop the traffic at ingress interface. We can use "show interface counters indiscard-stats" to verify the drop. Packets will be incremented in IBP Discards column.

Lossy option will drop the traffic at cpu. We can use "show interface cpu counters queue-stats" to verify the drop.

"disable l3-protocols-cpu vxlan" command is used, when sending traffic to vxlan interface. In Vxlan, arp and nd traffic will go to vxlan queue. Remaining traffics are considered as data traffic.

Configuring CPU Queuing Lossless

Do the following to configure CPU queuing on an interface.

#configure terminal	
(config)#bridge 1 protocol rstp	Configure Bridge 1
(config)#int xe52/2	
(config)#switchport	Configure interface as L2
(config-cmap-qos)#bridge-group 1	Configure bridge 1 in interface
(config-cmap-qos)#int xe52/3	
(config-cmap-qos)#switchport	Configure interface as L2
(config)#bridge-group 1	Configure bridge 1 in interface
(config-cmap-qos)#exit	
(config)#cpu-queue bpdu rate 600 lossless no-monitor	Configure bpdu cpu-queue with rate of 600 pps and lossless and no-monitor option

Validation

Enter the commands listed in the sections below to confirm the configurations.

```
R1(config)#do show running-config | inc cpu
cpu-queue bpdu rate 600 lossless no-monitor
R1(config)#
R1(config)#do show cpu-queue details
* - Can not configure the parameter
Cpu queue      Rate In PPS      Lossy Status      Monitor Status
Name           Configured      Default           Configured      Default           Configured      Default
=====
=====
sflow          -                32000            -               *lossy           -               monitor
bgp            -                1500             -               lossless         -               monitor
```

```

vrrp          -          500          -          lossless          -          monitor
ldp-rsvp      -          500          -          lossless          -          monitor
rip           -          500          -          lossless          -          monitor
ospf         -          2000         -          lossless          -          monitor
dhcp         -          100          -          lossy             -          no-
monitor
nd            -          6000         -          lossless          -          monitor
mpls         -          500          -          lossy             -          no-
monitor
pim          -          4000         -          *lossy            -          *no-
monitor
arp          -          6000         -          lossless          -          monitor
igmp        -          4000         -          *lossy            -          *no-
monitor
bpdu         600          10000         lossless          lossless          no-monitor      monitor
ccm          -          500          -          lossy             -          no-
monitor
bfd          -          2000         -          lossy             -          no-
monitor
ptp          -          1000         -          lossy             -          no-
monitor
isis         -          500          -          lossless          -          monitor
trill-isis   -          1000         -          lossless          -          monitor
acl          -          200          -          *lossy            -          *no-
monitor
vxlan        -          500          -          lossy             -          monitor

```

```

R1(config)#do clear interface cpu counters
R1(config)#do clear interface counters

```

```

R1(config)#do show interface counters rate

```

```

+-----+-----+-----+-----+-----+
+
|      Interface      |      Rx bps      |      Rx pps      |      Tx bps      |      Tx pps      |
|-----|-----|-----|-----|-----|
+-----+-----+-----+-----+-----+
+
po1              436              0              2980              5
po2              768714             1372             769045             1373
xe52/1           0                  0                  44                  0
xe52/2           0                  0                  263                  0
xe52/3           669424827          99971             263                  0
xe53/1           33                 0                  788                  1
xe53/2           33                 0                  719                  1
xe53/3           336                0                  702                  1
xe53/4           33                 0                  769                  1
xe54/1           192176             343               192014              342
xe54/2           192166             343               192292              343
xe54/3           192150             343               192348              343
xe54/4           192204             343               192390              343

```

```

R1(config)#do show interface cpu counters rate
Load interval: 30 second

```

```

+-----+-----+-----+-----+-----+
+
|      CPU Queue(%)   |      Rx bps      |      Rx pps      |      Tx bps      |      Tx pps      |
|-----|-----|-----|-----|-----|
+-----+-----+-----+-----+-----+
+
hw-bfd          ( N/A) -          -          101679             1374
bpdu            (100%) -          -          436856             600

```

```

ospf      ( 0%) -          -          84          0
bgp       ( 0%) -          -          44          0

```

```

R1(config)#do show interface cpu counters rate
Load interval: 30 second

```

	CPU Queue(%)	Rx bps	Rx pps	Tx bps	Tx pps
hw-bfd	(N/A) -	-	-	101574	1372
bpdu	(99%) -	-	-	433465	599
ospf	(0%) -	-	-	39	0
bgp	(0%) -	-	-	44	0

```

R1(config)#do show interface cpu counters queue-sta
E - Egress, I - Ingress, Q-Size is in bytes

```

Queue/Class-map	Q-Size	Tx pkts	Tx bytes	Dropped
hw-bfd 0	(E) 0	130582	9663068	0
bpdu 0	(E) 2706080	57086	41576707	0
arp 0	(E) 0	2	136	0
ospf 0	(E) 0	35	4658	0
bgp 0	(E) 0	95	7030	0

```

R1(config)#do show interface counters indiscard-stats

```

Interface	Port Block Drops	Vlan Discards	ACL/QOS Drops	Policy Discards
xe52/3	0	0	0	0
0	13080579	13080579	0	0

```

Configuring cpu-queue with lossy
=====

```

Configuring CPU Queuing Lossy

Do the following to configure CPU queuing on an interface.

#configure terminal	
R1(config)#cpu-queue bpdu rate 500 lossy no-monitor	Configure bpdu cpu-queue with rate of 500 pps and lossy and no-monitor option
R1(config-if)#exit	

Validation

Enter the commands listed in the sections below to confirm the configurations.

```
R1(config)#do clear interface cpu counters
R1(config)#do clear interface counters
R1(config)#do show running-config | inc cpu
cpu-queue bpdu rate 500 lossy no-monitor
disable l3-protocols-cpu vxlan
R1(config)#do show cpu-queue details
* - Can not configure the parameter
```

Cpu queue Name	Rate Configured	In PPS Default	Lossy Configured	Status Default	Monitor Configured	Status Default
sflow	-	32000	-	*lossy	-	monitor
bgp	-	1500	-	lossless	-	monitor
vrrp	-	500	-	lossless	-	monitor
ldp-rsvp	-	500	-	lossless	-	monitor
rip	-	500	-	lossless	-	monitor
ospf	-	2000	-	lossless	-	monitor
dhcp	-	100	-	lossy	-	no-
monitor						
nd	-	6000	-	lossless	-	monitor
mpls	-	500	-	lossy	-	no-
monitor						
pim	-	4000	-	*lossy	-	*no-
monitor						
arp	-	6000	-	lossless	-	monitor
igmp	-	4000	-	*lossy	-	*no-
monitor						
bpdu	500	10000	lossy	lossless	no-monitor	monitor
ccm	-	500	-	lossy	-	no-
monitor						
bfd	-	2000	-	lossy	-	no-
monitor						
ptp	-	1000	-	lossy	-	no-
monitor						
isis	-	500	-	lossless	-	monitor
trill-isis	-	1000	-	lossless	-	monitor
acl	-	200	-	*lossy	-	*no-
monitor						
vxlan	-	500	-	lossy	-	monitor

```
R1(config)#do show interface counters rate
```

Interface	Rx bps	Rx pps	Tx bps	Tx pps
po1	780	0	2974	5
po2	769353	1373	769260	1373
xe52/1	0	0	11	0
xe52/2	0	0	248	0
xe52/3	669564071	100000	248	0

FP Rules Queuing Configuration

```

xe53/1          98          0          871          1
xe53/2          98          0          692          1
xe53/3          485         0          699          1
xe53/4          98          0          710          1
xe54/1         192647        343        192322        343
xe54/2         191965        342        192280        343
xe54/3         192466        343        192278        343
xe54/4         192295        343        192416        343

```

```

R1(config)#do show interface cpu counters rate
Load interval: 30 second

```

```

+-----+-----+-----+-----+
| CPU Queue(%) | Rx bps | Rx pps | Tx bps | Tx pps |
+-----+-----+-----+-----+
+
hw-bfd      ( N/A) - -      101505      1371
bpdu        ( 99%) - -      345547      499
ospf        ( 0%) - -        74          0
bgp         ( 0%) - -        44          0

```

```

R1(config)#do show interface cpu counters rate
Load interval: 30 second

```

```

+-----+-----+-----+-----+
| CPU Queue(%) | Rx bps | Rx pps | Tx bps | Tx pps |
+-----+-----+-----+-----+
+
hw-bfd      ( N/A) - -      101505      1371
bpdu        ( 99%) - -      345547      499
ospf        ( 0%) - -        74          0
bgp         ( 0%) - -        44          0

```

```

R1(config)#do show cpu-queue details
cpu-queue bpdu rate 500 lossy no-monitor
disable l3-protocols-cpu vxlan

```

```

R1(config)#
R1(config)#

```

```

R1(config)#do show interface cpu counters queue-stats
E - Egress, I - Ingress, Q-Size is in bytes

```

```

+-----+-----+-----+-----+
| Queue/Class-map | Q-Size | Tx pkts | Tx bytes | Dropped |
| pkts | Dropped bytes | | | |
+-----+-----+-----+-----+
+
hw-bfd      (E) 0      78216      5787984      0
0
bpdu        (E) 978848 39290      27124511      7818876
6550244016
arp         (E) 0        2          136          0
0
ospf        (E) 0        21         3070         0
0
bgp         (E) 0        55         4070         0
0

```

```

R1(config)#do show interface counters indiscard-stats

```

```

+-----+-----+-----+-----+
+-----+-----+-----+-----+

```

Interface	Port Block Drops	Vlan Discards	ACL/QOS Drops	Policy Discards
Discards	EGR Port Unavail	IBP Discards	Total Discards	
xe53/3	4	0	0	0
xe54/1	3	0	0	0
xe54/2	2	0	0	0
xe54/3	1	0	0	0
xe54/4	3	0	0	0

CHAPTER 19 Explicit Congestion Notification (ECN) Configuration

Explicit congestion notification (ECN) enables end-to-end congestion notification between two endpoints on TCP/IP based networks. The two endpoints are an ECN-enabled sender and an ECN-enabled receiver. ECN must be enabled on both endpoints and on all of the intermediate devices between the endpoints for ECN to work properly. Any device in the transmission path that does not support ECN breaks the end-to-end ECN functionality.

WRED drops packets, based on the average queue length exceeding a specific threshold value, to indicate congestion. ECN is an extension to WRED in that ECN marks packets instead of dropping them when the average queue length exceeds a specific threshold value. When configured with the WRED -- Explicit Congestion Notification feature, routers and end hosts would use this marking as a signal that the network is congested and slow down sending packets.

ECN requires an ECN-specific field that has two bits--the ECN-capable Transport (ECT) bit and the CE (Congestion Experienced) bit--in the IP header. The ECT bit and the CE bit can be used to make four ECN field combinations of 00 to 11. The first number is the ECT bit and the second number is the CE bit. The table below lists each of the ECT and CE bit combination settings in the ECN field and what the combinations indicate.

Table 19-1 explains the output fields.

Table 19-1: show bfd fields

ECT Bit	CE Bit	Combination Indicates
0	0	Not- ECN capable
0	1	Endpoints of the transport protocol are ECN capable
1	0	Endpoints of the transport protocol
1	1	Congestion experienced

The ECN field combination 00 indicates that a packet is not using ECN. The ECN field combinations of 01 and 10 called as ECT(1) and ECT(0) respectively. This sets by the data sender to indicate that the endpoints of the transport protocol are ECN-capable. Routers treat those two field combinations identically. Data senders can use either one or both of these two combinations.

ECN is Enabled

If the number of packets in the queue is below the minimum threshold, packets are transmitted. This happens whether or not ECN is enabled, and this treatment is identical to the treatment a packet receives when WRED only is being used on the network.

If the number of packets in the queue is between the minimum threshold and the maximum threshold, one of the following three scenarios can occur:

If the ECN field on the packet indicates that the endpoints are ECN-capable (that is, the ECT bit is set to 1 and the CE bit is set to 0, or the ECT bit is set to 0 and the CE bit is set to 1)--and the WRED algorithm determines that the packet should have been dropped based on the drop probability--the ECT and CE bits for the packet are changed to 1, and the packet is transmitted. This happens because ECN is enabled and the packet gets marked instead of dropped.

If the ECN field on the packet indicates that neither endpoint is ECN-capable (that is, the ECT bit is set to 0 and the CE bit is set to 0), the packet might be dropped based on the WRED drop probability. This is the identical treatment that a packet receives when WRED is enabled without ECN configured on the router.

If the ECN field on the packet indicates that the network is experiencing congestion (that is, both the ECT bit and the CE bit are set to 1), the packet is transmitted. No further marking is required.

If the number of packets in the queue is above the maximum threshold, packets are dropped based on the drop probability. This is the identical treatment a packet receives when WRED is enabled without ECN configured on the router.

Topology



Figure 19-19: Simple configuration of ECN

Configuring ECN on L3 Interface

Do the following to configure ECN on an L3 interface.

#configure terminal	Enter inside configure mode
(config)#qos enable	Enable QoS on configuration mode.
(config)#qos statistics enable	QoS statistics on configuration mode.
(config)#class-map match-any cmap	Enter Class-map mode
(cmap-qos-match-any-mode)#match precedence 3	Configure match criteria as precedence with Value 3
(config-pmap-qos)#policy-map pmap	Enter policy-map mode
(config-pmap-qos)#class cmap	Assign Class cmap to Policy-map pmap
(cmap-qos-match-any-mode)#match precedence 3	Configure match criteria as precedence with Value 3
(config-pmap-qos)#policy-map pmap	Enter policy-map mode
(config-pmap-qos)#class cmap	Assign Class cmap to Policy-map pmap
(config-pmap-c-qos)# police cir 328 mbps pir 556 mbps conform transmit exceed transmit violate transmit	Police Precedence 3 frames @ Committed information rate of 328 mbps and pir 556 mbps conform transmit exceed transmit violate transmit.
(config-pmap-c-qos)#end	Exit out of policy-class-map mode
#configure terminal	Enter inside configure mode
(config)#interface xe29	Enter interface mode
(config-if)#service-policy type qos input pmap	Assign service-policy to interface on in-direction
(config-if)#exit	Exit interface mode
(config)#policy-map type queuing default xyz	Enter policy-map queuing mode
(config-pmap-que-def)#class type queuing default q3	Enter class-map type queuing
(config-pmap-c-que-def)#shape percent 80	Configure shape percent 80 in q3

(config-pmap-c-que-def)# random-detect min-threshold 100 max-threshold 200 packets ecn	Configure ECN with Random Early Detection which includes minimum and maximum threshold in packets
#configure terminal	Enter configure mode
(config)#interface xe30	Enter interface mode
(config-if)#service-policy type queuing output xyz	Attach policy on egress interface
OcNOS (config-if)#exit	Exit configure mode

Validation

Enter the commands listed in the sections below to confirm the configurations.

```
OcNOS#show policy-map interface xe30
Interface xe30
Global statistics status : enabled
Service-policy (queuing) output: xyz
-----
Class-map (queuing): q0
  priority level 1
    output      : 0 packets, 0 bytes
    dropped     : 0 packets, 0 bytes
Class-map (queuing): q1
  priority level 1
    output      : 0 packets, 0 bytes
    dropped     : 0 packets, 0 bytes
Class-map (queuing): q2
  priority level 1
    output      : 0 packets, 0 bytes
    dropped     : 0 packets, 0 bytes
Class-map (queuing): q3
  shape percent 80
  priority level 1
  random-detect min-threshold 100 max-threshold 200 packets ecn
    output      : 44808 packets, 67210500 bytes
    dropped     : 10516 packets, 15774000 bytes
Class-map (queuing): q4
  priority level 1
    output      : 0 packets, 0 bytes
    dropped     : 0 packets, 0 bytes
Class-map (queuing): q5
  priority level 1
    output      : 0 packets, 0 bytes
    dropped     : 0 packets, 0 bytes
Class-map (queuing): q6
  priority level 1
    output      : 0 packets, 0 bytes
    dropped     : 0 packets, 0 bytes
Class-map (queuing): q7
  priority level 1
    output      : 0 packets, 0 bytes
    dropped     : 0 packets, 0 bytes
Class-map (queuing): mc-q0
  output      : 0 packets, 0 bytes
  dropped     : 0 packets, 0 bytes
```

```
Class-map (queuing): mc-q1
  output      : 0 packets, 0 bytes
  dropped     : 0 packets, 0 bytes
Class-map (queuing): mc-q2
  output      : 0 packets, 0 bytes
  dropped     : 0 packets, 0 bytes
Class-map (queuing): mc-q3
  output      : 0 packets, 0 bytes
  dropped     : 0 packets, 0 bytes
Class-map (queuing): mc-q4
  output      : 0 packets, 0 bytes
  dropped     : 0 packets, 0 bytes
Class-map (queuing): mc-q5
  output      : 0 packets, 0 bytes
  dropped     : 0 packets, 0 bytes
Class-map (queuing): mc-q6
  output      : 0 packets, 0 bytes
  dropped     : 0 packets, 0 bytes
Class-map (queuing): mc-q7
  output      : 0 packets, 0 bytes
  dropped     : 0 packets, 0 bytes
Wred Drop Statistics:
green  : 0 packets
yellow : 0 packets
red    : 0 packets
```

Topology



Figure 19-20: Simple configuration of ECN

Configuring ECN on L2 Interface

Do the following to configure ECN on an L2 interface.

#configure terminal	Enter inside configure mode
(config)#bridge 1 protocol mstp	Configure bridge 1 as MSTP aware
(config)#interface xe29	Enter interface mode
(config-if)#switchport	Configure xe29 as a layer 2 port
(config-if)#bridge-group 1	Associate bridge to an interface
(config-if)#switchport mode trunk	Configure port as trunk
(config-if)#switchport trunk allowed vlan all	Allow all the vlan on the interface xe29
(config-if)#exit	Exit the xe29 interface mode
(config)#interface xe30	Enter interface mode

(config-if)#switchport	Configure xe30 as a layer 2 port
(config-if)#bridge-group 1	Associate bridge to an interface
(config-if)#switchport mode trunk	Configure port as trunk
(config-if)#switchport trunk allowed vlan all	Allow all the vlan on the interface xe30
(config-if)#exit	Exit the xe30 interface mode
(config)#qos enable	Enable QoS on configuration mode
(config)#qos statistics	Enable QoS statistics on configuration mode
(config)#class-map match-any cmap	Enter Class-map mode
(cmap-qos-match-any-mode)#match precedence 3	Configure match criteria as precedence with Value 3
(config-pmap-qos)#policy-map pmap	Enter policy-map mode
(config-pmap-qos)#class cmap	Assign Class cmap to Policy-map pmap
(config-pmap-c-qos)# police cir 328 mbps pir 556 mbps conform transmit exceed transmit violate transmit	Police Precedence 3 frames @ Committed information rate of 328 mbps and pir 556 mbps conform transmit exceed transmit violate transmit.
(config-pmap-c-qos)#end	Exit out of policy-class-map mode
#configure terminal	Enter inside configure mode
(config)#interface xe29	Enter interface mode
(config-if)#trust dscp	Configure trust DSCP on the interface xe29
(config-if)#service-policy type qos input pmap	Assign service-policy to interface on in-direction
(config-if)#exit	Exit interface mode
(config)#policy-map type queuing default xyz	Enter policy-map queuing mode
(config-pmap-que-def)#class type queuing default q3	Enter class-map type queuing
(config-pmap-c-que-def)#shape average 900 mbps	Configure shape average 900 in q3
(config-pmap-c-que-def)#random-detect green 1000 2000 yellow 3000 4000 red 5000 6000 bytes ecn	Configure ECN with Random Early Detection which includes minimum and maximum threshold for green, yellow and red packets
(config-pmap-c-que-def)#end	Exit pmap mode
#configure terminal	Enter configure mode
(config)#interface xe30	Enter interface mode
(config-if)#service-policy type queuing output xyz	Attach policy on egress interface
OcNOS (config-if)#exit	Exit configure mode

Validation

Enter the commands listed in the sections below to confirm the configurations.

```
OcNOS#show policy-map interface xe30
Interface xe30
Global statistics status : enabled
Service-policy (queuing) output: xyz
-----
Class-map (queuing) : q0
```

Explicit Congestion Notification (ECN) Configuration

```
priority level 1
  output      : 0 packets, 0 bytes
  dropped     : 0 packets, 0 bytes
Class-map (queuing): q1
  priority level 1
    output      : 0 packets, 0 bytes
    dropped     : 0 packets, 0 bytes
Class-map (queuing): q2
  priority level 1
    output      : 0 packets, 0 bytes
    dropped     : 0 packets, 0 bytes
Class-map (queuing): q3
  shape average 900 mbps
  priority level 1
    random-detect green min-threshold 1000 max-threshold 2000 yellow minimum-threshold 3000 max-threshold 4000 red min-threshold 5000 maximum-threshold 6000 bytes ecn
    output      : 308318 packets, 462477000 bytes
    dropped     : 29774 packets, 44661000 bytes
Class-map (queuing): q4
  priority level 1
    output      : 0 packets, 0 bytes
    dropped     : 0 packets, 0 bytes
Class-map (queuing): q5
  priority level 1
    output      : 0 packets, 0 bytes
    dropped     : 0 packets, 0 bytes
Class-map (queuing): q6
  priority level 1
    output      : 0 packets, 0 bytes
    dropped     : 0 packets, 0 bytes
Class-map (queuing): q7
  priority level 1
    output      : 3 packets, 369 bytes
    dropped     : 0 packets, 0 bytes
Class-map (queuing): mc-q0
  output      : 0 packets, 0 bytes
  dropped     : 0 packets, 0 bytes

Class-map (queuing): mc-q1
  output      : 0 packets, 0 bytes
  dropped     : 0 packets, 0 bytes
Class-map (queuing): mc-q2
  output      : 0 packets, 0 bytes
  dropped     : 0 packets, 0 bytes
Class-map (queuing): mc-q3
  output      : 0 packets, 0 bytes
  dropped     : 0 packets, 0 bytes
Class-map (queuing): mc-q4
  output      : 0 packets, 0 bytes
  dropped     : 0 packets, 0 bytes
Class-map (queuing): mc-q5
  output      : 0 packets, 0 bytes
  dropped     : 0 packets, 0 bytes
Class-map (queuing): mc-q6
  output      : 0 packets, 0 bytes
  dropped     : 0 packets, 0 bytes
```

```
Class-map (queuing): mc-q7
  output      : 0 packets, 0 bytes
  dropped     : 0 packets, 0 bytes
Wred Drop Statistics :
-----
green  : 0 packets
yellow : 0 packets
red    : 0 packets
```

CHAPTER 20 Rate Limiting BUM Traffic

To prevent the CPU from getting flooded with Broadcast, Unknown Unicast, and Multicast (BUM) traffic, rate limiting can be applied at the ingress interface. This configuration is called “storm control” and is independent of the QoS feature, and can be configured directly on the interface in the ingress direction.

Configuring per port rate limiting for BUM traffic

BUM rate limiting can be configured on the interface via following command:

```
storm-control (broadcast|multicast|dlf) (level LEVEL | <0-4294967294>
(kbps|mbps|gbps|fps)) (burst-size <32-128000>|)
```

The `broadcast` option is for broadcast traffic, `multicast` option is for multicast traffic and `dlf` (Destination Lookup Failure) option is for unknown unicast traffic.

There are two ways to configure the rate limiting information. One is in percentage and the other is in absolute values. Use the `level` option to configure in percentage format where the link speed is used for rate calculation. Percentage value can be configured with up to four fractional digits in order to support kbps level rate limiting on 100 gbps ports, and the Absolute configuration option uses the input rate in kbps, mbps, fps, or gbps.

Burst-size is an optional parameter, if storm control is not configured with burst-size, default value is calculated as 5ms of configured rate to limit the traffic. Minimum of 32 Kbps burst will be allocated if the calculated value is below 32 Kbps.

An example of BUM rate limiting is shown below:

```
(config)#interface xe1
(config-if)#switchport
(config-if)#storm-control dlf 2 mbps
(config-if)#exit
```

In the configuration above, unknown unicast traffic received on `xe1` will be rate limited to 1.98 mbps. Burst-size is calculated as 32 Kbps.

Note: Minimum granularity for storm-control is 64kbps.

Note: Burst-range in XGS is 32-128000 Kbps.

Note: Storm Discard notification is sent in case of packet discards but not based on configuration.

Storm Detection Time

Rate-limit setting should take place immediately after detecting storm. With existing burst size, rate limit is happening after few seconds, if burst size should be changed to a lower value so that rate-limiting happens immediately on the switch. Also, user have a provision to change burst size through CLI.

An example of BUM rate limiting with Burst-size configuration is shown below:

```
(config)#interface xe1
(config-if)#switchport
(config-if)#storm-control broadcast 600 kbps burst-size 15
(config-if)#exit
```

In the configuration above, broadcast traffic received on `xe1` will be rate limited to 576 kbps and Burst-size is configured as 40 Kbps. If traffic sent at 700 kbps. Time taken to detect the storm should be 0.32 Seconds.

Storm Control Notifications

When storm control occurs in switch, there is no direct way for the user to identify the storm apart from discard counters with "show storm-control" CLI. So SNMP trap and syslog notifications are generated for the user to know about the storm control.

If storm-control occurs, based on the rate-limit discard counters, a Syslog notification and SNMP trap is generated. As the rate-limit packet discards stops, another syslog notification and SNMP trap is generated that storm packet discards are stopped.

Displaying BUM rate limit information

Use the following command to verify BUM rate limit configuration:

```
show storm-control (INTERFACE-NAME|)
```

```
show storm-control
```

```
*The hardware applicable value is displayed
```

Port	BcastLevel (burst)	McastLevel (burst)	DlfLevel (burst)	Discards
xel	576.000 kbps (40 Kbps)	100.0000% (0 Kbps)	1.984 mbps (32 Kbps)	125411

```
2021 Sep 23 19:51:09.639 : OcNOS : HSL : NOTIF : [IF_STORM_DISCARDS_4]: Storm control discards started on interface xel total discards 364173
```

```
2021 Sep 23 19:52:45.740 : OcNOS : HSL : NOTIF : [IF_STORM_DISCARDS_4]: Storm control discards stopped on interface xel total discards 1272806
```

Quality of Service Command Reference

CHAPTER 1 Quality of Service Commands

This chapter is a reference for the ingress Quality of Service (QoS) and hierarchical QoS.

- [bandwidth](#)
- [class-map type qos](#)
- [class-map type queuing](#)
- [class type qos](#)
- [class type queuing](#)
- [clear qos statistics](#)
- [cpu-queue](#)
- [egress cos map](#)
- [egress dscp map](#)
- [ingress cos map](#)
- [ingress dscp map](#)
- [ingress exp map](#)
- [Lossless](#)
- [match access-group](#)
- [match cos](#)
- [match cos inner](#)
- [match dscp](#)
- [match ip rtp](#)
- [match mac](#)
- [match precedence](#)
- [match protocol](#)
- [match qos-group](#)
- [match traffic-type](#)
- [match vlan](#)
- [match vlan inner](#)
- [police](#)
- [policy-map](#)
- [priority](#)
- [priority \(queuing\)](#)
- [qos \(enable | disable\)](#)
- [qos map-profile](#)
- [qos profile](#)
- [qos profile precedence-to-queue](#)
- [qos profile queue-to-precedence](#)
- [qos remark](#)

- qos statistics
- queue-limit
- random-detect
- service-policy
- service-policy type qos
- service-policy type queuing
- set bridge cos
- set bridge dscp
- set cos
- set dscp
- set mpls class
- set precedence
- set qos-group
- set qos queue scheduler
- set queue
- shape
- shape rate
- show class-map
- show cpu-queue details
- show policy-map
- show policy-map interface
- show qos-profile
- show qos-profile interface
- show queuing interface
- show running-config qos
- show running-config cpu-queue
- storm-control
- trust dscp
- wrr-queue weight

bandwidth

Use this command to allocate a minimum percentage of the interface bandwidth to a queue.

Use the `no` command to remove a bandwidth configuration.

Command Syntax

```
bandwidth (<1-1000000000> (kpbs|mbps|gbps) | percent <1-100>)  
no bandwidth
```

Parameters

<1-1000000000>	Bandwidth value
kpbs	Units in kilobits/sec.
mbps	Units in megabits/sec.
gbps	Units in gigabits/sec.
percent	Specify the percentage from 1 to 100.

Default

No default value is specified

Command Mode

Policy-class-map mode

Applicability

This command was introduced before OcNOS version 1.3.

This command applies only to the Trident II, Trident II+, and Tomahawk platforms.

Examples

```
(config)# policy-map type queuing PQOS  
(config-pmap-que)# class type queuing 1p7q4t-out-pq1  
(config-pmap-c-que)# bandwidth 10 mbps
```

class-map type qos

Use this command to create a class-map of type qos.

Use the `no` command to remove a class-map.

Note: Class-map without any match qualification behaves similar to default class by matching all the packets on the interface it is attached via service policy.

In a class-map, adding or deleting match criteria with misconfiguration will have silent exit and will not proceed with operation.

Command Syntax

```
class-map (type qos|) (match-any|match-all|) NAME
no class-map (type qos|) (match-any|match-all|) NAME
```

Parameters

NAME	Specify the class map name (Max Size 32)
match-any	Match any parameter (boolean OR)
match-all	Match all parameters (boolean AND)

Default

By default, match type is match-all for any class-map

Command Mode

Configuration Mode

Applicability

This command was introduced before OcNOS version 1.3.

Examples

```
#configure terminal
(config)# class-map type qos C_QOS1
```

class-map type queuing

Use this command to create a class-map of type queuing.

Use the `no` command to remove a class-map.

Note: Class-maps with no action are treated as incomplete configuration and don't take any effect until the action is added. Class-map deletion is not allowed if it is referenced by any policy-map.

Command Syntax

```
class-map type queuing (match-any|) NAME
no class-map type queuing (match-any|) NAME
```

Parameters

NAME	Specify the class map name (Max Size 32)
match-any	Match any parameter (boolean OR)

Default

By default, class-map type is match-any

Command Mode

Configuration Mode

Applicability

This command was introduced before OcNOS version 1.3.

This command applies only to the Trident II and Trident II+ platforms.

Examples

```
#configure terminal
(config)# class-map type queuing C_QOS1
```

class type qos

Use this command to add a QoS class-map to a qos policy map.

Use the `no` command to remove a QoS class-map from the policy map.

Note: Implicit priority of the classes in a policy-map will be calculated based on the number of matches with VLAN match given lower weight-age over other matches. In case of classes with conflicting matches, it is not guaranteed which class the traffic would hit. Users are recommended to use priority in such cases.

Command Syntax

```
class (type qos|) (NAME|class-default)
no class (type qos|) (NAME|class-default)
```

Parameters

NAME Specify the class map name

Default

By default, class is type qos

Command Mode

Policy-map mode

Applicability

This command was introduced before OcnOS version 1.3.

Examples

```
(config)#
(config)#policy-map type qos PP
(config-pmap-que)#class type qos C_PP_1
```

class type queuing

Use this command to add a queuing class-map to a queuing policy map.

Use the `no` command to remove a queuing class-map from the policy map.

Command Syntax

```
class (type queuing ((default (q0|q1|q2|q3|q4|q5|q6|q7))|NAME) | NAME | queuing
class-default)
no class (type queuing|) NAME
```

Parameters

NAME	Specify the class map name
<q0-q7>	Default queue name

Default

No default value is specified

Command Mode

Policy Map type queuing Mode

Applicability

This command was introduced before OcNOS version 1.3.

Examples

```
(config)#
(config)#policy-map type queuing PP
(config-pmap-que)#class type queuing C_PP_1
```

clear qos statistics

Use this command to clear the quality of service (QoS) statistics.

Command Syntax

```
clear qos statistics (interface IFNAME|) ((type all| type qos| type qos input| type
  qos output| type queuing)|)
```

Parameters

NAME	Specify which interface to clear.
type all	Clear all statistics from QoS and Queuing types.
type qos	Clear all statistics from QoS type.
type qos input	Clear all statistics from QoS input type.
type qos output	Clear all statistics from QoS output type.
type queuing	Clear all statistics from queuing type.

Default

By default, type QoS, type queuing class statistics on all interfaces will be cleared, if no parameters configured.

Command Mode

Privileged Exec mode

Applicability

This command was introduced before OcNOS version 1.3.

Examples

```
#clear qos statistics
```

cpu-queue

Use this command to configure create a cpu queue for vxlan.

Use the `no` form of this command to remove a cpu queue.

Command Syntax

```
cpu-queue <queue-name> ( (rate <value>|) (lossy|lossless|) (monitor|no-monitor|) )
```

```
no cpu-queue <queue-name> ( (rate|) (lossy|lossless|) (monitor|no-monitor) |)
```

Parameters

<code>queue-name</code>	Name of the cpu queue
<code>rate</code>	When the packets are uplifted
<code>lossy</code>	If enabled, packets are dropped at cpu-queue when the cpu-queues congested
<code>loseless</code>	If enabled, packets are dropped at ingress port
<code>monitor</code>	Enable logging when cpu-queue discards packets
<code>no-monitor</code>	Disable logging

Default

Default value for vxlan `cpu-queue` command is 500.

Command Mode

Configure mode

Applicability

This command was introduced before OcNOS version 1.3.8

Example

```
#configure terminal
(config)#cpu-queue cpu rate 500
(config-dscp-queue)#exit
```

egress cos map

Use this command to map a queue value to the CoS value.

Use the `no` form of this command to remove the map.

Note: Egress CoS map will be taking effect only when remark CoS is enabled.

Note: Color is an optional parameter. If not provided, the same map will be set for all colors.

Note: If ingress qos policy-map is configured with set cos action on ingress interface, set action will take priority over egress cos map and packet will egress out with set cos value.

Command Syntax

```
queue <0-7> (color (green|yellow|red|all)|) cos <0-7>
no queue <0-7> (color (green|yellow|red|all)|)
```

Parameters

<0-7>	Identifying queue number
color	(green yellow red all)
<0-7>	CoS value

Default

By default, CoS to queue mapping is one to one.

Command Mode

Egress cos map mode

Applicability

This command was introduced in OcNOS DC version 4.2.

This command applies only to the Trident II, Trident II+, and Tomahawk platforms.

Example

```
(config)#qos profile queue-color-to-cos default
(config-egress-cos-map)#queue 1 color green cos 5
(config-egress-cos-map)#queue 1 cos 6
```

Color is an optional parameter. So if users do not provide color, for all colors same CoS remarking will be set. If user provides color, then only for that specific color egress map will be changed. If user provides map for all colors as well as without color, map with color will take priority.

```
(config-egress-cos-map)#no queue 1 color green
(config-egress-cos-map)#no queue 1
```

If user want to remove all the mapping of queue (for all colors) no need to provide color, else can provide specific color to remove specific map .

egress dscp map

Use this command to map a queue to a DSCP value.

Use the `no` form of this command to remove the map.

Note: Egress DSCP map will be taking effect only when remark DSCP is enabled.

Note: Color is an optional parameter. If not provided, the same map will be set for all colors.

Note: If ingress qos policy-map is configured with `set dscp/precedence` action on ingress interface, set action will take priority over egress dscp map and packet will egress out with set scp/precedence value.

Command Syntax

```
queue <0-7> (color (green|yellow|red|all) |) dscp <0-63>
no queue <0-7> (color (green|yellow|red|all) |)
```

Parameters

<0-7>	Identifying queue number
color	(green yellow red all)
<0-63>	DSCP value

Default

By default, 8 DSCP values are mapped to one queue.

For example: DSCP 0-7 queue 0, DSCP 8-15 queue 1.

Command Mode

Egress dscp map mode

Applicability

This command was introduced in OcNOS DC version 4.2

This command applies only to the Trident II, Trident II+, and Tomahawk platforms.

Example

```
(config)#qos profile queue-color-to-dscp default
(config-egress-dscp-map)#queue 2 color yellow dscp 40
(config-egress-dscp-map)#queue 2 dscp 36
```

If user specifies color in map then map will be set for that specific color else for all colors same map will be set.

```
(config-egress-dscp-map)#no queue 2 color yellow
(config-egress-dscp-map)#no queue 2
```

If user want to remove all the mapping of dscp (for all colors) no need to provide color, else can provide specific color to remove specific map.

ingress cos map

Use this command to map a CoS value to the queue.

Use the `no` form of this command to remove the map.

Command Syntax

```
cos <0-7> (dei (0|1|all)|) queue <0-7> (color (green|yellow|red)|)
no cos <0-7> (dei (0|1|all)|)
```

Parameters

<0-7>	CoS value
dei	Drop Eligible Indicator (0 1 all)
<0-7>	Identifying queue number
color	(green yellow red)

Default

By default, CoS to queue mapping is one to one, and DEI 0 will be mapped to color "green" and DEI 1 will be mapped to color "yellow".

Command Mode

Ingress cos map mode

Applicability

This command was introduced in OcNOS DC version 4.2.

This command applies only to the Trident II, Trident II+, and Tomahawk platforms.

Example

```
(config)#qos profile cos-to-queue default
(config-ingress-cos-map)#cos 1 queue 2
```

ingress dscp map

Use this command to map a DSCP value to the queue.

Use the `no` form of this command to remove the map.

Note: Color is an optional parameter. If not provided, it will be set as the default value. Please refer the Configuration Guide for the default value table.

Command Syntax

```
dscp <0-63> queue <0-7> (color (green|yellow|red) |)
no dscp <0-63>
```

Parameters

<code><0-63></code>	DSCP value
<code><0-7></code>	Identifying queue number
<code>color</code>	(green yellow red)

Default

By default, 8 DSCP values are mapped to one queue.

For example: DSCP 0-7 queue 0, DSCP 8-15 queue 1.

Command Mode

Ingress dscp map mode

Applicability

This command was introduced in OcNOS DC version 4.2.

This command applies only to the Trident II, Trident II+, and Tomahawk platforms.

Example

```
(config)#qos profile dscp-to-queue default
(config-ingress-dscp-map)#dscp 1 queue 2
```

ingress exp map

Use this command to map a exp value to the queue.

Use the `no` form of this command to remove the map.

Note: Color is an optional parameter. If not provided, color will be set to green.

Command Syntax

```
exp <0-7> queue <0-7> (color (green|yellow|red) |)
no exp <0-7>
```

Parameters

<0-7>	EXP value
<0-7>	Identifying queue number
color	(green yellow red)

Default

By default, EXP to queue mapping is one to one.

Command Mode

Ingress exp queue map mode

Applicability

This command was introduced in OcNOS DC version 4.2.

Example

```
(config)#qos profile exp-to-queue default
(config-ingress-exp-queue-map)#exp 1 queue 4 color green
(config-ingress-exp-queue-map)#exp 2 queue 3
```

Lossless

Use this command to enable lossless setting on egress queue.

Command Syntax

```
(no|) lossless
```

Parameters

None

Default

Disabled

Command Mode

Policy-class-map-queue mode

Applicability

This command was introduced in OcNOS version 6.2.

Example

```
OcNOS#con t
OcNOS(config)#policy-map type queuing default p1
OcNOS(config-pmap-que)#class type queuing default q0
OcNOS(config-pmap-c-que)#lossless
```

match access-group

Use this command to classify the group based on the access group.

Use the `no` command to remove access group match criteria from a class map

Command Syntax

```
match access-group NAME
no match access-group NAME
```

Parameters

NAME Specify the access group name

Default

No default value is specified

Command Mode

Class-map mode

Applicability

This command was introduced before OcNOS version 1.3.

Examples

```
(config)# class-map class_acl
(config-cmap-qos)# match access-group my_acl
```

match cos

Use this command to classify the traffic based on cos

Use the `no` command to remove the match configuration.

Note: The match commands which accept range have silent exit which makes removal of these match configurations easier. For example, classify the traffic based on cos using the command `match cos 2,4,6` and remove the match configuration using the command `no match cos 2-6`.

Command Syntax

```
match cos WORD
```

```
no match cos
```

Parameters

WORD	CoS value or list of specified CoS values. Valid values are from 0 to 7.
all	Delete all matched cos entries.

Default

No default value is specified

Command Mode

Class-map mode

Applicability

This command was introduced before OcNOS version 1.3.

Examples

```
(config)#class-map type qos C_QOS1  
(config-cmap-qos)#match cos 1
```

match cos inner

Use this command to classify the traffic based on inner cos.

Use the `no` command to remove the match configuration.

Note: The match commands which accept range have silent exit which makes removal of these match configurations easier. For example, classify the traffic based on inner cos using the command `match cos inner 2,4,6` and remove the match configuration using the command `no match cos inner 2-6`.

Command Syntax

```
match cos inner WORD
no match cos inner
```

Parameters

WORD	Inner CoS value or list of specified CoS values. Valid values are from 0 to 7.
all	Delete all matched cos entries.

Default

No default value is specified

Command Mode

Class-map mode

Applicability

This command was introduced before OcNOS version 1.3.

Examples

```
(config)#class-map type qos C_QOS1
(config-cmap-qos)#match cos inner 1
```

match dscp

Use this command to classify the traffic based on dscp.

Use the `no` command to remove the configured dscp value.

Note: The match commands which accept range have silent exit which makes removal of these match configurations easier. For example, classify the traffic based on dscp using the command `match dscp 2,4,6` and remove the match configuration using the command `no match dscp 2-6`.

Command Syntax

```
match dscp [WORD | af11 | af12 | af13 | af21 | af22 | af23 | af31 | af32 | af33 |
  af41 | af42 | af43 | cs1 | cs2 | cs3 | cs4 | cs5 | cs6 | cs7 | default | ef]
no match dscp
```

Parameters

WORD	<0-63> List of DSCP values.
af11	AF11 dscp (001010).
af12	AF12 dscp (001100)
af13	AF13 dscp (001110)
af21	AF21 dscp (010010)
af22	AF22 dscp (010100)
af23	AF23 dscp (010110)
af31	AF31 dscp (011010)
af32	AF32 dscp (011100)
af33	AF33 dscp (011110)
af41	AF41 dscp (100010)
af42	AF42 dscp (100100)
af43	AF43 dscp (100110)
cs1	CS1(precedence 1) dscp (001000)
cs2	CS2(precedence 2) dscp (010000)
cs3	CS3(precedence 3) dscp (011000)
cs4	CS4(precedence 4) dscp (100000)
cs5	CS5(precedence 5) dscp (101000)
cs6	CS6(precedence 6) dscp (110000)
cs7	CS7(precedence 7) dscp (111000)
default	Default dscp (000000)
ef	EF dscp (101110)
all	Delete all matched DSCP values.

Default

No default value is specified

Command Mode

Class-map mode

Applicability

This command was introduced before OcNOS version 1.3.

Examples

```
(config)#class-map type qos C_QOS7  
(config-cmap-qos)#match dscp 48-55
```

match ip rtp

Use this command to configure a class map to use the Real-Time Protocol (RTP) port as a match criteria.

Use the `no` command to remove the RTP port as a match criteria.

Note: The match commands which accept range have silent exit which makes removal of these match configurations easier. For example, classify the traffic based on RTP port using the command `match ip rtp 5000,7000,9000` and remove the match configuration using the command `no match ip rtp 5000-9000`.

Command Syntax

```
match ip rtp WORD
no match ip rtp
```

Parameters

WORD	Specify User Datagram Protocol (UDP) or list of UDP ports that are using RTP. Valid values are from 2000 to 65535.
all	Delete all matched IP RTP values.

Default

No default value is specified

Command Mode

Class-map type qos

Applicability

This command was introduced before OcnOS version 1.3.

Examples

```
(config)# class-map my_test
(config-cmap-qos)# match ip rtp 2300
```

match mac

Use this command to classify based on the mac address (can be source or destination or both)

Use the `no` command to remove the match configuration.

Command Syntax

```
match mac (src |dest ) (XX:XX:XX:XX:XX:XX | XX-XX-XX-XX-XX-XX | XXXX.XXXX.XXXX)
no match mac (src |dest )
```

Parameters

<code>mac</code>	Ethernet mac address
<code>src</code>	specifies the source mac
<code>dest</code>	specifies the destination mac
<code>XX:XX:XX:XX:XX:XX</code>	MAC address option 1
<code>XX-XX-XX-XX-XX-XX</code>	MAC address option 2
<code>XXXX.XXXX.XXXX</code>	MAC address option 3

Default

No default value is specified

Command Mode

Class-map mode

Applicability

This command was introduced before OcNOS version 1.3.

Examples

```
(config)#class-map type qos C_QOS1
(config-cmap-qos)#match mac src 11:22:33:44:55:66
(config-cmap-qos)#match mac dest 3344.5566.7788
```

match precedence

Use this command to traffic classification based on precedence.

Use the `no` command to remove the match configuration.

Note: The match commands which accept range have silent exit which makes removal of these match configurations easier. For example, classify the traffic based on precedence using the command `match precedence 2,4,6` and remove the match configuration using the command `no match precedence 2-6`.

Command Syntax

```
match precedence [WORD | critical | flash | flash-override | immediate | internet |
network | priority | routine | 0-7]
no match precedence
```

Parameters

<code>word</code>	IP precedence value
<code>critical</code>	Critical precedence
<code>flash</code>	Flash precedence
<code>flash-override</code>	Flash override precedence
<code>immediate</code>	Immediate precedence
<code>internet</code>	Internetwork control precedence
<code>network</code>	Network control precedence
<code>priority</code>	Priority precedence
<code>routine</code>	Routine precedence
<code>all</code>	Delete all matched IP precedence values.
<code>0-7</code>	Valid values are in range 0-7

Default

No default value is specified

Command Mode

Class-map mode

Applicability

This command was introduced before OcNOS version 1.3.

Examples

```
(config)# class-map my_test
(config-cmap-qos)# match precedence 7
```

match protocol

Use this command to classify traffic based on protocol.

Use the `no` command to remove the specified protocol as a match criteria.

Command Syntax

```
match protocol (arp | bridging | cdp | clns | clns-is | clns-es | dhcp | isis | ldp |
netbios )
no match protocol
```

Parameters

<code>arp</code>	Address Resolution Protocol (ARP)
<code>bridging</code>	Bridging
<code>cdp</code>	Cisco Discovery Protocol (CDP)
<code>clns</code>	Connection-less Network Service (CLNS)
<code>clns-is</code>	CLNS Intermediate System
<code>clns-es</code>	CLNS end System
<code>dhcp</code>	Dynamic Host Configuration (DHCP)
<code>isis</code>	Intermediate system to intermediate system (IS-IS)
<code>ldp</code>	Label Distribution Protocol (LDP)
<code>netbios</code>	NetBIOS Extended User Interface (NetBEUI)
<code>all</code>	Delete all matched protocols.

Default

No default value is specified

Command Mode

Class-map mode

Applicability

This command was introduced before OcNOS version 1.3.

Examples

```
(config)# class-map my_test
(config-cmap-qos)# match protocol ldp
```

match qos-group

Use this command to match a QoS group in a type queuing class map.

Use the `no` to remove a QoS match on a queue number from a type queuing class map.

Command Syntax

```
match qos-group <1-2000>
no match qos-group <1-2000>
```

Parameters

<1-2000> Specify qos group value or list of qos group values specified in bytes.

Default

No default value is specified

Command Mode

Class-map mode

Applicability

This command was introduced before OcNOS version 1.3.

This command applies only to Trident II and Trident II+ platforms.

Examples

```
(config)#
(config)#class-map type queuing match-any C_PP_1
(config-cmap-que)#match qos-group 1
```

match traffic-type

Use this command to classify based on traffic-type

Use the `no` command to remove the match configuration.

Note: Class with match traffic type default will have lower priority over class with other traffic type match.

Command Syntax

```
match traffic-type (l2-uc|l2-uc-unknown|default)
no match traffic-type (l2-uc|l2-uc-unknown|default)
```

Parameters

Traffic-type	type of traffic to be matched
l2-uc	L2 Unicast traffic
l2-uc-unknown	Unknown L2 Unicast traffic
default	All other traffic-types

Default

No default value is specified

Command Mode

Class-map mode

Applicability

This command was introduced before OcNOS version 1.3.

This command applies only to the Trident II, Trident II+, and Tomahawk platforms.

Examples

```
(config)#class-map type qos C_QOS1
(config-cmap-qos)#match traffic-type l2-uc
```

match vlan

Use this command to classify the traffic based on a VLAN.

Use the `no` command to remove the match configuration.

Note: The match commands which accept range have silent exit which makes removal of these match configurations easier. For example, classify the traffic based on VLAN using the command `match vlan 2,4,6` and remove the match configuration using the command `no match vlan 2-6`.

Command Syntax

```
match vlan WORD
no match vlan (WORD|all)
```

Parameters

<code>not</code>	Match all except this.
<code>WORD</code>	Enter VLAN ID <1-4094> or range of VLAN ID's separated by commas. For example, 2 or 2,4-5 or 50,51,52 or 100-120,122-130 etc.
<code>all</code>	Delete all VLAN ID entries.

Default

No default value is specified

Command Mode

Class-map mode

Applicability

This command was introduced before OcnOS version 1.3.

Examples

```
(config)#class-map type qos C_QOS1
(config-cmap-qos)#match vlan 1
```

match vlan inner

Use this command to classify the traffic based on the inner VLAN.

Use the `no` command to remove the match configuration.

Note: The match commands which accept range have silent exit which makes removal of these match configurations easier. For example, classify the traffic based on the inner VLAN using the command `match vlan inner 2,4,6` and remove the match configuration using the command `no match vlan inner 2-6`.

Command Syntax

```
match vlan inner WORD
no match vlan inner (WORD|all)
```

Parameters

<code>not</code>	Match all except this.
<code>WORD</code>	Enter VLAN ID <1-4094> or list of VLAN ID's separated by commas. For example, 2,4 etc.
<code>all</code>	Delete all VLAN ID entries.

Default

No default value is specified

Command Mode

Class-map mode

Applicability

This command was introduced before OcnOS version 1.3.

Examples

```
(config)#class-map type qos C_QOS1
(config-cmap-qos)#match vlan inner 1
```

police

Use this command to configure policing of the data rates for a particular class of traffic.

Use the `no` command to remove a policing configuration.

Note: Committed Information Rate (CIR) and Peak Information Rate (PIR) can only be whole numbers.

Command Syntax

```
police (colour-blind | colour-aware |) (cir) (<1-2000000000> (kbps|mbps|gbps) |
percent <1-100>) ((pir (<1-2000000000> (kbps|mbps|gbps) | percent <1-100>)) |) (bc)
<1-256000> (kbytes|mbytes|ms|us) |) ((be)<1-256000>
(kbytes|mbytes|ms|us) |) ((conform (transmit | set-prec-transmit <0-7> | set-dscp-
transmit <0-63> | set-cos-transmit <0-7> | set-mpls-class <0-7> )) |) ((exceed
(drop | set-dscp-transmit <0-63> | set-cos-transmit <0-7> | transmit | set-mpls-
class <0-7> )) |) ((violate (drop | set-dscp-transmit <0-63> | set-cos-transmit
<0-7> | transmit | set-mpls-class <0-7> )) |))
no police
```

Parameters

<code>colour-blind</code>	Do not police on color.
<code>colour-aware</code>	Do police on color.
<code>cir <1-2000000000></code>	Specify Committed information rate.
<code>pir <1-2000000000></code>	Peak information rate.
<code>kbps</code>	Specify the units of kbps per second.
<code>mbps</code>	Specify the units of mbps per second.
<code>gbps</code>	Specify the units of gbps per second.
<code>Percent</code>	Specify the rate in percent.
<code>bc <1-256000></code>	Burst rate committed.
<code>be <1-256000></code>	Burst rate extended.
<code>transmit</code>	Specify the action of transmitting packets.
<code>set-prec-transmit</code>	Sets the IP precedence field to the specified value and transmits the packet.
<code>set-dscp-transmit</code>	Sets the Differentiated Service Code Point (DSCP) field to the specified value and transmits the packet.
<code>set-cos-transmit</code>	Sets the class of service (CoS) field to the specified value and transmits the packet.
<code>set-mpls-class</code>	Set the mpls class filed to the give value and tx the packet

drop	Specify the action of dropping packets.
conform	Sets the action to take when the data rate is within bounds
exceed	Sets the action to take when the data rate is exceeded. Default is drop.
violate	Sets the action to take when the data rate violates the configured rate values. The default is drop.

Default

Table 1-2: Default values

Parameter	Default
policer-type	Color-Blind
cir	N/A
pir	0
bc	0
be	0
conform	Transmit
exceed	Drop
violate	Drop

Command Mode

Policy-map mode

Applicability

This command was introduced before OcNOS version 1.3.

Examples

```
(config)# policy-map type qos 2345
(config-pmap-qos)#class type qos 2345
(config-pmap-c-qos)# police cir 2 mbps pir 4 mbps bc 2 mbytes be 4 mbytes conform
transmit exceed set-cos-transmit 1 violate drop
```

Usage

Traffic policing is based on the concept of *marking* IP packets, and then *metering* the packets in relation to how they are marked. This is called the “Two Rate Three Color Marker (trTCM)” process.

The Two Rate Three Color Marker (trTCM) meters an IP packet stream, and marks its packets as either green, yellow, or red. A packet is marked RED if it exceeds the *Peak Information Rate* (PIR). Otherwise it is marked either YELLOW or GREEN depending on whether it exceeds or does not exceed the Committed Information Rate (CIR). The trTCM is useful, for example, for ingress policing of a service, where a peak rate needs to be enforced separately from a committed rate.

The Meter meters each packet and passes the packet and the metering result to the Marker. The Meter operates in one of two modes – Color-Blind or Color-Aware. In the Color-Blind mode, the Meter assumes that the packet stream is

uncolored. In the Color-Aware mode, the Meter assumes that some preceding entity has pre-colored the incoming packet stream so that each packet is either GREEN, YELLOW, or RED.

The following describes the equations used to determine the BC and BE values:

Note: CIR, PIR, BC, and BE values are all in kbits/sec.

=====

```
BC = CIR * 5 / 1000;
Range check [64kbytes-256mbytes]
if (BC / 8) < 64)
then BC = 64 * 8;
else if (BC / 8) > 256000)
then BC = 256000 * 8;
```

=====

Same calculation for BE, as well.

Note: If the PIR value is not mentioned in the configuration, then the CIR value itself is considered for BE calculation.

=====

```
BE = PIR * 5 / 1000;
Range check [64kbytes-256mbytes]
if (BE / 8) < 64)
then BE = 64 * 8;
else if (BE / 8) > 256000)
then BE = 256000 * 8;
```

=====

For example:

Configure: police CIR 1 mbps

Hardware: CIR = 1000kbits/sec , BC = 512kbits, BE = 512kbits

Configure: police CIR 1 mbps PIR 200 mbps

Hardware: CIR = 1000kbits/sec, BC = 512kbits, PIR = 200000kbits/sec, BE = 1000kbits

For additional information regarding policing, see RFC 2697 and RFC 2698.

policy-map

Use this command to create a policy map and enter policy-map mode.

Use the `no` command to remove a policy map.

Note: You cannot delete a policy map if it is attached to an interface.

Command Syntax

```
policy-map {NAME | (type (qos|queuing (|default)) NAME)}  
no policy-map {NAME | (type (qos|queuing (|default)) NAME)}
```

Parameters

NAME	Policy map name (maximum 32 characters)
qos	QoS policy map
queuing	Queuing policy map

Default

No default value is specified

Command Mode

Configuration mode

Applicability

This command was introduced before OcNOS version 1.3.

Examples

```
(config)#  
(config)#policy-map type qos PQOS
```

priority

Use this command to set the user priority for the class attached to this policy-map.

Use the `no` parameter with this command to unset the priority value.

Note: The higher the priority number, higher the priority for the class in a policy-map. User configured priority takes effect over default priority.

Command Syntax

```
priority <1-1000>
no priority
```

Parameters

<1-1000> Priority value

Default

No default value is specified

Command Mode

Policy-class-map mode

Applicability

This command was introduced before OcNOS version 1.3.

Examples

```
#configure terminal
(config)#policy-map pmap1
(config-pmap)#class cmap1
(config-pmap-c)#priority 20
```

priority (queuing)

Use this command to configure a single output queuing class as the priority queue.

Note: Priority can be set only on default queues (such as queues in the default queuing policy-map).

Command Syntax

```
priority
```

Parameters

None

Default

No default value is specified. Higher priority queue will have higher priority always when set.

Command Mode

Policy map-class type queuing mode

Applicability

This command was introduced before OcNOS version 1.3.

This command applies only to the Trident II, Trident II+, and Tomahawk platforms.

Examples

```
#configure terminal
(config)#policy-map type queuing default default-out-policy
(config-pmap-que)#class type queuing default q0
(config-pmap-c-que)#priority
```

qos (enable | disable)

Use this command to globally enable or disable Quality-of-Service (QoS).

Note: Enabling or disabling QoS is a disruptive operation, stopping all traffic on ports which causes traffic loss.

Command Syntax

```
qos (enable | disable)
```

Parameters

None

Default

By default, QoS is enabled.

Command Mode

Configure

Applicability

This command was introduced before OcNOS version 1.3.

Examples

```
#configure terminal
(config)# qos enable

(config)#qos disable
```

qos map-profile

Use this command to attach (map) a profile to an interface.

Use the no form of this command to remove a profile.

Note: By-default, "default" profiles are attached on their supported interfaces (cos-to-queue and queue-to-cos on L2 interfaces and DSCP-to-queue and queue-color-to-DSCP on L3 interfaces).

Note: You can create and attach your own profile to supported interfaces. After removing a user-defined profiles from an interface, the "default" profile is applied.

Command Syntax

```
qos map-profile (cos-to-queue | dscp-to-queue | queue-color-to-cos | queue-color-  
to-dscp | precedence-to-queue | queue-to-precedence) NAME  
no qos map-profile (cos-to-queue | dscp-to-queue | queue-color-to-cos | queue-  
color-to-dscp| precedence-to-queue | queue-to-precedence) NAME
```

Parameters

cos-to-queue	Profile for CoS to queue map
dscp-to-queue	Profile for DSCP to queue map
queue-color-to-cos	Profile for queue color to CoS map
queue-color-to-dscp	Profile for queue color to DSCP map
precedence-to-queue	profile for precedence to queue map
queue-to-precedence	profile for queue to precedence map
NAME	Profile map name (maximum 32 characters)

Default

By default, the default cos-to-queue-profile is applied to an L2 interface, and the default DSCP-to-queue profile is attached to an L3 interface.

Command Mode

Interface modes

Applicability

This command was introduced in OcNOS DC version 4.2.

This command applies only to the Trident II, Trident II+, and Tomahawk platforms.

Example

```
(config-if)#qos map-profile cos-to-queue cos-map  
(config-if)#qos map-profile dscp-to-queue dscp-map  
(config-if)#qos map-profile queue-color-to-cos egress-cos-map  
(config-if)#qos map-profile queue-color-to-dscp q-to-dscp-map
```

qos profile

Use this command to create new profiles or to update "default" profiles.

Use the no form of this command to remove the "user-defined" profiles, or to undo custom updates in "default" profiles.

Command Syntax

```
qos profile (cos-to-queue | dscp-to-queue | queue-color-to-cos | queue-color-to-
dscp) (NAME|default)
no qos profile (cos-to-queue | dscp-to-queue | queue-color-to-cos | queue-color-to-
dscp) (NAME|default)
```

Parameters

cos-to-queue	Profile for CoS to queue map
dscp-to-queue	Profile for DSCP to queue map
queue-color-to-cos	Profile for queue color to CoS map
queue-color-to-dscp	Profile for queue color to DSCP map
NAME	Profile map name (maximum 32 characters)

Default

By default, "default" profile is created for all the profile types. These profiles can only be updated by the user neither be created nor be destroyed.

Command Mode

Configure modes

Applicability

This command was introduced in OcNOS DC version 4.2.

This command applies only to the Trident II, Trident II+, and Tomahawk platforms.

Example

To create a new profile:

```
(config)#qos profile cos-to-queue cos-map
(config)#qos profile dscp-to-queue dscp-map
(config)#qos profile queue-color-to-cos egress-cos-map
(config)#qos profile queue-color-to-dscp q-to-dscp-map
```

To update the "default" profile:

```
(config)#qos profile cos-to-queue default
(config)#qos profile dscp-to-queue default
(config)#qos profile queue-color-to-cos default
```

```
(config)#qos profile queue-color-to-dscp default
```

qos profile precedence-to-queue

Use this command to set the precedence to queue profile.

Use the no form of this command delete the profile.

Use [show qos-profile](#) to show the profile detail.

Use [qos map-profile](#) to map the profile on interface.

Command Syntax

```
qos profile precedence-to-queue (NAME|)
precedence <0-7> queue <0-7>
no qos profile precedence-to-queue (NAME|)
no precedence <0-7> queue <0-7>
```

Parameters

NAME	The profile name to be created
precedence <0-7>	Precedence value
queue <0-7>	The queue value

Command Mode

Configure modes

Applicability

This command was introduced in OcNOS-SP version 5.0.

Example

```
#configure terminal
(config)#qos profile precedence-to-queue prec-map
(config-ingress-prec-map)#precedence 1 queue 1
(config)#interface xel
(config-if)#qos map-profile precedence-to-queue prec-map
```

qos profile queue-to-precedence

Use this command to set the queue to precedence profile.

Use the `no` form of this command delete the profile.

Use [show qos-profile](#) to show the profile detail.

Use [qos map-profile](#) to map the profile on interface.

Command Syntax

```
qos profile queue-to-precedence (NAME|)
queue <0-7> precedence <0-7>
no qos profile queue-to-precedence (NAME|)
no queue <0-7> precedence <0-7>
```

Parameters

NAME	The profile name to be created
queue <0-7>	The queue value
precedence <0-7>	Precedence value

Command Mode

Configure modes

Applicability

This command was introduced in OcNOS-SP version 5.0.

Example

```
#configure terminal
(config)#qos profile queue-to-precedence egress-prec-map
(config-egress-prec-map)#queue 1 precedence 0
(config)#interface xe2
(config-if)#qos map-profile queue-to-precedence egress-prec-map
```

qos remark

Use this command to enable remarking of the Class of service (CoS) and Differentiated Services Control Protocol (DSCP) set by the egress map.

Use the `no` command to disable remarking of the CoS and DSCP.

Command Syntax

In Config mode :

```
qos remark (cos|dei|dscp)
no qos remark (cos|dei|dscp)
```

In interface mode:

```
qos remark (cos|dei|dscp) (enable|disable)
no qos remark (cos|dei|dscp)
```

Parameters

`type` Remarking type. For example, CoS or DEI (Drop Eligible Indicator bit) or DSCP
`(enable|disable)` Remarking action

Default

By default, remarking is disabled.

Command Mode

Configure mode, Interface mode

Applicability

This command was introduced in OcNOS DC version 4.2.

This command applies only to the Trident II, Trident II+, and Tomahawk platforms.

Examples

```
((config)#qos remark cos
(config)#qos remark dscp
(config-if)# qos remark cos disable
(config-if)# qos remark cos enable
(config-if)# qos remark dscp disable
```

Interface remarking will take priority over global remarking configurations.

qos statistics

Use this command to enable Quality of Service (QoS) statistics.

Use the `no` command to disable QoS statistics

Note: Class-map statistics is cleared whenever the match or action property of the class is modified dynamically.

Command Syntax

```
qos statistics
no qos statistics
```

Parameters

None

Default

By default, QoS statistics is disabled

Command Mode

Configure Mode

Applicability

This command was introduced before OcNOS version 1.3.

Examples

```
(config)#qos statistics
(config)#
```

queue-limit

Use this command to configure tail drop by setting queue limits on egress queues.

Use the `no` command to remove a queue limit.

Command Syntax

```
queue-limit (<1-524288>) (packets | bytes | kbytes | percent)
no queue-limit
```

Parameters

<code><1-524288></code>	Specify queue-limit in packets, bytes, percent or Kilobytes. Max value for bytes is 524288 Max value for kilobytes is 512 Max value for packets is 600 Max value of percent is 100
-------------------------------	--

Default

No default value is specified

Command Mode

Policy-class-map mode

Applicability

This command was introduced before OcNOS version 1.3.

This command applies only to the Trident II, Trident II+, and Tomahawk platforms.

Examples

```
(config)# policy-map type queuing P1
(config-pmap-que)#class type queuing q1
(config-pmap-c-que)# queue-limit percent 50
```

random-detect

Use this command to configure weighted random early detection (WRED).

Use the `no` command to remove a WRED configuration.

Note: Explicit Congestion Notification (ECN) ECN-WRED is independent of WRED and max queue size parameters. With ECN, queue size can be reached until default max queue size is exceeded.

Command Syntax

```
random-detect green (min-threshold|)<1-524288> (max-threshold|)<1-524288> (drop-  
probability <1-100>|) yellow (min-threshold|)<1-524288> (max-threshold|)<1-  
524288> (drop-probability <1-100>|) red (min-threshold|)<1-524288> (max-  
threshold|)<1-524288>) (packets | bytes |  
kbytes) (ecn|)  
random-detect (min-threshold|)<1-524288> (max-threshold|)<1-524288> (packets |  
bytes | kbytes) (drop-probability <1-100>|) (ecn|)  
random-detect weight <0-15>  
no random-detect  
no random-detect weight
```

Parameters

<code>min-threshold</code>	Specify the minimum threshold. In the range of <1-524288>
<code>max-threshold</code>	Specify the maximum threshold. In the range of <1-524288>
<code>drop-probability</code>	Specify the probability of dropping. In the range <1-100>
<code>Packets, bytes, kbytes</code>	Specify the thresholds in Packets, Bytes, or Kilobytes.
<code>ecn</code>	Explicit Congestion Notification
<code>weight</code>	Specify the weight level . In the range <0-15>

Default

No default value is specified

Command Mode

Policy-class map mode

Applicability

This command was introduced before OcnOS version 1.3.

Drop-probability and weight were introduced on OcnOS DC version 4.2.

This command applies only to the Trident II, Trident II+, Trident III, Tomahawk, and Helix platforms.

Examples

```
(config)# policy-map type queuing default xyz
(config-pmap-que)#class type queuing default q1
(config-pmap-c-que)#random-detect min-threshold 200 max-threshold 512 kbytes
drop-probability 50 ecn
(config-pmap-c-que)#random-detect weight 10
(config-pmap-c-que)#no random-detect
```

service-policy

Use this command to attach a child policy onto a parent policy.

Use the `no` command detach child policy from the parent policy.

Command Syntax

```
service-policy NAME
no service-policy NAME
```

Parameters

`NAME` Specify the policy map to attach to the parent policy.

Default

No default value is specified

Command Mode

Policy-class-map queuing mode

Applicability

This command was introduced before OcNOS version 1.3.

This command applies only to the Trident II and Trident II+ platforms.

Examples

```
(config)#policy-map type queuing P1
(config-pmap-que)#class type queuing empty5b
(config-pmap-c-que)#service-policy PQOS
```

service-policy type qos

Use this command to attach a service-policy of type qos to the interface.

Use the `no` command to remove a service-policy from an interface.

Command Syntax

```
service-policy type qos (input|output) NAME
no service-policy type qos (input|output) NAME
```

Parameters

<code>type</code>	Specify whether the policy map is of type qos.
<code>NAME</code>	Specify the policy map to attach to this interface.

Default

No default value is specified

Command Mode

Interface mode

Applicability

This command was introduced before OcnOS version 1.3.

Examples

```
(config)#int xe3
(config-if)#service-policy type qos input PQOS
```

service-policy type queuing

Use this command to attach a service-policy of type queuing to the interface.

Use the `no` command to remove a service-policy from an interface.

Command Syntax

```
service-policy type queuing output NAME
no service-policy type queuing output NAME
```

Parameters

<code>type</code>	Specify whether the policy map is of type queuing.
<code>NAME</code>	Specify the policy map to attach to this interface.

Default

By default, default-out-policy is attached on all interface

Command Mode

Interface mode

Applicability

This command was introduced before OcNOS version 1.3.

Examples

```
(config)#int xe3
(config-if)#service-policy type queuing output PQOS
```

set bridge cos

Use this command to set the Class-of-Service (CoS) value for L2 packets only.

Use the `no` parameter with this command to unset a CoS value.

Command Syntax

```
set bridge cos (<0-7>)  
no set bridge cos
```

Parameters

<0-7> CoS value.

Default

No default value is specified

Command Mode

Policy-class-map mode

Applicability

This command was introduced before OcNOS version 1.3.

This command applies only to the Trident II, Trident II+, and Tomahawk platforms.

Examples

```
#configure terminal  
(config)#policy-map pmap1  
(config-pmap)#class cmap1  
(config-pmap-c)#set bridge cos 2
```

set bridge dscp

Use this command to set the DSCP value for L3 packets only.

Use the `no` parameter with this command to unset a DSCP value.

Command Syntax

```
set bridge dscp (<0-63>|af11| af12| af13| af21| af22| af23| af31|
                af32| af33| af41| af42| af43| cs1| cs2| cs3| cs4| cs5|
                cs6| cs7| default| ef )
no set bridge dscp
```

Parameters

<0-63>	DSCP value
af11	DSCP (001011) decimal value 11
af12	DSCP (001100) decimal value 12
af13	DSCP (001101) decimal value 13
af21	DSCP (010101) decimal value 21
af22	DSCP (010110) decimal value 22
af23	DSCP (010111) decimal value 23
af31	DSCP (011111) decimal value 31
af32	DSCP (010000) decimal value 32
af33	DSCP (010001) decimal value 33
af41	DSCP (101001) decimal value 41
af42	DSCP (101010) decimal value 42
af43	DSCP (101011) decimal value 38
cs1	(Precedence 1) DSCP (001000) decimal value 8
cs2	(Precedence 2) DSCP (010000) decimal value 16
cs3	(Precedence 3) DSCP (011000) decimal value 24
cs4	(Precedence 4) DSCP (100000) decimal value 32
cs5	(Precedence 5) DSCP (101000) decimal value 40
cs6	(Precedence 6) DSCP (110000) decimal value 48
cs7	(Precedence 7) DSCP (111000) decimal value 56
default	DSCP (000000) decimal value 0
ef	DSCP (101110) decimal value 46

Default

No default value is specified

Command Mode

Policy-class-map mode

Applicability

This command was introduced before OcnOS version 1.3.

This command applies only to the Trident II, Trident II+, and Tomahawk platforms.

Examples

```
#configure terminal
(config)#policy-map pmap1
(config-pmap)#class cmap1
(config-pmap-c)#set bridge dscp 25
```

set cos

Use this command for matching traffic classes set action as change cos in the egress packet to the prescribed value. Use the `no command` to remove the assigned value from the class.

Command Syntax

```
set cos <0-7>
no set cos
```

Parameters

<0-7> Specify CoS value to assign for this class of traffic

Default

No default value is specified

Command Mode

Policy-map mode

Applicability

This command was introduced before OcNOS version 1.3.

This command applies only to the Trident II, Trident II+, and Tomahawk platforms.

Examples

```
(config)# policy-map my_policy1
(config-pmap-qos)# class traffic_class2
(config-pmap-c-qos)# no set cos
(config-pmap-c-qos)#
```

set dscp

Use this command for matching traffic classes set action as change DSCP in the egress packet to the prescribed value.

Use the `no` command to remove the assigned value from the class

Command Syntax

```
set dscp (<0-63>|af11| af12| af13| af21| af22| af23| af31|
          af32| af33| af41| af42| af43| cs1| cs2| cs3| cs4| cs5|
          cs6| cs7| default| ef )

no set dscp
```

Parameters

<0-63>	DSCP value
af11	DSCP (001011) decimal value 11
af12	DSCP (001100) decimal value 12
af13	DSCP (001101) decimal value 13
af21	DSCP (010101) decimal value 21
af22	DSCP (010110) decimal value 22
af23	DSCP (010111) decimal value 23
af31	DSCP (011111) decimal value 31
af32	DSCP (010000) decimal value 32
af33	DSCP (010001) decimal value 33
af41	DSCP (101001) decimal value 41
af42	DSCP (101010) decimal value 42
af43	DSCP (101011) decimal value 38
cs1	(Precedence 1) DSCP (001000) decimal value 8
cs2	(Precedence 2) DSCP (010000) decimal value 16
cs3	(Precedence 3) DSCP (011000) decimal value 24
cs4	(Precedence 4) DSCP (100000) decimal value 32
cs5	(Precedence 5) DSCP (101000) decimal value 40
cs6	(Precedence 6) DSCP (110000) decimal value 48
cs7	(Precedence 7) DSCP (111000) decimal value 56
default	DSCP (000000) decimal value 0
ef	DSCP (101110) decimal value 46

Default

No default value is specified

Command Mode

Policy map class mode

Applicability

This command was introduced before OcNOS version 1.3.

This command applies only to the Trident II, Trident II+, and Tomahawk platforms.

Examples

```
#configure terminal
(config)#policy-map pmap1
(config-pmap)#class cmap1
(config-pmap-c)#set dscp af12
```

set mpls class

Use this command to set mpls class(queue) for the matched packet.

Use the no command to remove the assigned value from the class.

Command Syntax

```
set mpls class <0-7>
no set mpls class
```

Parameters

<0-7> Specify class value to assign for this traffic.

Default

No default value is specified

Command Mode

Policy-map type qos

Applicability

This command was introduced before OcNOS version 1.3.

This command applies only to the Trident II, Trident II+, and Tomahawk platforms.

Examples

```
(config)# policy-map my_policy1
(config-pmap-qos)# class traffic_class2
(config-pmap-c-qos)# set mpls class 3
(config-pmap-c-qos)#
```

set precedence

Use this command for matching traffic classes set action as change precedence in the egress packet to the prescribed value.

Use the `no` command to leave the precedence value unchanged for the class

Command Syntax

```
set (precedence (<0-7>| critical| flash | flash-override|immediate|internet|
network| priority| routine))
no set precedence
```

Parameters

<code><0-7></code>	Specify IP precedence value to assign for this class of traffic
<code>critical</code>	Critical precedence
<code>flash</code>	Flash precedence
<code>flash-override</code>	Flash override precedence
<code>immediate</code>	Immediate precedence
<code>internet</code>	Internet network control precedence
<code>network</code>	Network control precedence
<code>priority</code>	Priority precedence
<code>routine</code>	Routine precedence

Default

No default value is specified

Command Mode

Policy-map mode

Applicability

This command was introduced before OcnOS version 1.3.

This command applies only to the Trident II, Trident II+, and Tomahawk platforms.

Examples

```
(config)# policy-map policy1
(config-pmap-qos)# class class2
(config-pmap-c-qos)# set precedence 3
(config-pmap-c-qos)#
```

set qos-group

Use this command to match a QoS group in a type queuing class map.

Use the `no` command to remove a QoS group match on a queue number from a type queuing class map.

Command Syntax

```
set qos-group <1-2000>
no set qos-group <1-2000>
```

Parameters

<1-2000> Specify the QoS group value to assign for this class of traffic.

Default

No default value is specified

Command Mode

Policy-class-map mode

Applicability

This command was introduced before OcNOS version 1.3.

This command applies only to the Trident II and Trident II+ platforms.

Examples

```
(config)#
(config)#policy-map type qos PQOS
(config-pmap-qos)#class type qos C_QOS1
(config-pmap-c-qos)#set qos-group 1
```

set qos queue scheduler

Use this command to change the scheduler mode of Unicast Queue and Non-Unicast queue groups to WRR or SP.

Use the `no` command to disable the set mode, and to change to the default mode

Command Syntax

```
set qos ((wrr uc <1-127> non-uc <1-127>) | sp)
no set qos (wrr|sp)
```

Parameters

<code>wrr</code>	Weighted Round Robin Mode
<code>uc</code>	Unicast Queues from 1 to 127
<code>non-uc</code>	Non-Unicast Queues from 1 to 127
<code>sp</code>	Strict Priority Mode

Default

The default is WRR with 32:2.

Command Mode

Configure Mode

Applicability

This command was introduced before OcNOS version 1.3 for platforms Trident II and Trident II+

Tomahawk support is provided with OcNOS DC version 4.2.

Tomahawk supports only `wrr` setting between `uc` and `mc` queues.

Examples

```
(config)#set qos wrr uc 30 non-uc 40
(config)#no set qos wrr
```

set queue

Use this command for matching traffic classes set action as change cos in the egress packet to the prescribed value.

Use the `no` command to remove the assigned value from the class.

Command Syntax

```
set queue <0-7>
no set queue
```

Parameters

<0-7> Specify queue value to assign for this class of traffic

Default

No default value is specified

Command Mode

Policy-map mode

Applicability

This command was introduced before OcNOS version 1.3.

This command applies only to the Trident II, Trident II+, and Tomahawk platforms.

Examples

```
(config)# policy-map my_policy1
(config-pmap-qos)# class traffic_class2
(config-pmap-c-qos)# set queue 4
(config-pmap-c-qos)#
```

shape

Use this command to configure shaping on an egress queue to impose a maximum rate on it.

Use the `no` command to remove a shaping configuration.

Command Syntax

```
shape (<1-1000000000> (kbps|mbps|gbps) | percent <1-100>)  
no shape
```

Parameters

average	Specify an optional keyword. Shaping is based on an average rate. Average rate for shaping in the range of <1-1000000000>
kbps	Specify the units of kbps per second.
mbps	Specify the units of mbps per second.
gbps	Specify the units of gbps per second.
percent	Specify the percentage from 1 to 100.

Default

No default value is specified

Command Mode

Policy-class-map mode

Applicability

This command was introduced before OcNOS version 1.3.

Examples

```
(config)# policy-map type queuing my_queue  
(config-pmap-que)# class type queuing PQOS  
(config-pmap-c-que)# shape percent 25  
(config-pmap-c-que)#
```

shape rate

Use this command to configure shaping on an egress port to impose a maximum rate on it.

Use the `no` form of the command to remove a shaping configuration.

Command Syntax

```
shape rate <1-1000000000> (kbps|mbps|gbps) burst SHAPE_BURST_RATE
no shape rate
```

Parameters

<1-1000000000> Average rate for shaping in the following range:

8 kbps to 1000 gbps for Trident3

1 kbps to 1000 gbps for other XGS platforms

kbps Units of kbps per second.

mbps Units of mbps per second.

gbps Units of gbps per second.

SHAPE_BURST_RATE

Burst value in kbits in the following range:

<2-1000000> for Trident3 and tomahwak

<1-1000000> for other XGS platforms

Default

N/A

Command Mode

Interface mode

Applicability

This command was introduced in OcNOS version 1.3.8.

Examples

```
(config)#interface xe11
(config-if)#shape rate 100 mbps burst 20
```

show class-map

Use this command to display qos/queuing class maps.

Command Syntax

```
show class-map (type (qos|queuing)|) (NAME|)
```

Parameters

NAME Specify the named class map

Command Mode

Exec mode

Applicability

This command was introduced before OcnOS version 1.3.

Examples

```
#show class-map type qos
Type qos class-maps
=====
class-map type qos 1234
match cos 3
class-map type qos 2345
QOS-ACCESS-LIST-NAME: 101
```

```
#show class-map 1234
Type qos class-maps
=====
class-map type qos 1234
match cos 3
```

show cpu-queue details

Use this command to display details about CPU queue for QoS.

Command Syntax

```
show cpu-queue details
```

Parameters

None

Command Mode

Exec mode

Applicability

This command was introduced before OcNOS version 1.3.8

Example

```
#show cpu-queue details
```

```
* - Can not configure the parameter
```

Cpu queue Name	Rate In PPS		Lossy Status		Monitor Status	
	Configured	Default	Configured	Default	Configured	Default
sflow	10000	32000	-	*lossy	no-monitor	monitor
bgp	-	1500	-	lossless	-	monitor
vrrp	-	500	-	lossless	-	monitor
ldp-rsvp	-	500	-	lossless	-	monitor
rip	-	500	-	lossless	-	monitor
ospf	0	2000	lossy	lossless	monitor	monitor
dhcp	-	100	-	lossy	-	no-monitor
nd	200	6000	lossless	lossless	monitor	monitor
mpls	-	500	-	lossy	-	no-monitor
pim	-	4000	-	*lossy	-	*no-monitor
arp	100	6000	lossy	lossless	no-monitor	monitor
igmp	-	4000	-	*lossy	-	*no-monitor
bpdu	1000	10000	-	lossless	monitor	monitor
ccm	-	500	-	lossy	-	no-monitor
bfd	-	2000	-	lossy	-	no-monitor
ptp	-	1000	-	lossy	-	no-monitor
isis	-	500	-	lossless	-	monitor
trill-isis	-	1000	-	lossless	-	monitor
acl	-	200	-	*lossy	-	*no-monitor

```
vxlan          -          500          -          lossy          -          monitor
```

Table 1-3 explains the output fields.

Table 1-3: show CPU Queue fields

Entry	Description
CPU queue name	Name of the CPU queue
Rate In PPS	At which packets are successfully delivered
Lossy Status	Status of the network lossy or lossless
Monitor Status	Status of the network monitor

show policy-map

Use this command to display:

1. Type qos/queuing policy-map
2. Non zero statistics for type qos or queuing classes on interfaces

Command Syntax

```
show policy-map statistics type queuing default
show policy-map statistics type queuing
```

Parameters

qos	Type qos policy-map
statistics	Displays QoS statistics.
queuing	Type queuing policy-maps
default	Default queue of the port
Interface	Interface on which to get policy-map statistics
NAME	Specify named policy map.

Command Mode

Exec and Configure mode

Applicability

This command was introduced before OcNOS version 1.3.

Examples

```
E1#show policy-map statistics
Type qos class-map statistics:
+-----+-----+-----+-----+
| Class-map | Match pkts | Match bytes | Dropped pkts | Dropped Bytes |
+-----+-----+-----+-----+
ce29/1
C1          100          6796          0          0

Type queuing class-map statistics:
+-----+-----+-----+-----+
| Class-map | Total pkts | Total bytes | Dropped pkts | Dropped Bytes |
+-----+-----+-----+-----+
ce1/1
q7          1689          108888          0          0
ce2/1
q6          8            912            0          0
ce5/1
q6          8            912            0          0
ce29/1
q7          104          7052            0          0
E1#
E1#show policy-map type qos st
E1#show policy-map statistics type qos ?
| Output modifiers

    Output redirection
    <cr>

E1#show policy-map statistics type qos
```

Quality of Service Commands

```
+-----+-----+-----+-----+
|          Class-map          | Match pkts | Match bytes | Dropped pkts | Dropped Bytes |
+-----+-----+-----+-----+
ce29/1
C1                          100          6796          0              0
P1#,
```

P1#show version

Software version: EC_AS7712-32X-OcNOS-6.0.0-DC-MPLS-Alpha 07/14/2022 09:25:41
Copyright (C) 2022 IP Infusion. All rights reserved

Software Product: OcNOS, Version: 6.0.0
Build Number: 132
Release: Alpha
Hardware Model: Edgecore 7712-32X-O-AC-F
Software Feature Code: DC-MPLS
Software Baseline Version: 5.0.145

Installation Information:

Image Filename: OcNOS-6.0.0.132-DC_MPLS-Alpha-installer
ONIE SysInfo: x86_64-accton_as7712_32x-r0

P1#

show policy-map interface

Use this command to display the statistics and the configurations of the input and output policies that are attached to an interface.

Command Syntax

```
show policy-map interface (NAME (input | output | ) (type (qos | queuing)|) | brief)
```

Parameters

NAME	Policy name.
brief	brief policy interface.

Command Mode

Exec mode

Applicability

This command was introduced before OcNOS version 1.3.

Examples

```
#show policy-map interface xe19/1

Interface xe19/1
Global statistics status : enabled

Service-policy (qos) input : p1
-----
Class-map (qos): c1 (match all)
match vlan 2
police cir 2 mbps
    matched      : 0 packets, 0 bytes
    dropped      : 0 packets, 0 bytes

Class-map (qos): c3 (match all)
police cir 2 mbps
    matched      : 2172408 packets, 2172408000 bytes
    dropped      : 2128959 packets, 2128959000 bytes

Service-policy (queuing) output: default-out-policy
-----
Class-map (queuing): q0
priority level 1
bandwidth percent 1
    output       : 0 packets, 0 bytes
    dropped      : 0 packets, 0 bytes

Class-map (queuing): q1
priority level 1
```

```
bandwidth percent 1
  output      : 0 packets, 0 bytes
  dropped     : 0 packets, 0 bytes
```

```
Class-map (queuing): q2
priority level 1
bandwidth percent 1
  output      : 0 packets, 0 bytes
  dropped     : 0 packets, 0 bytes
```

```
Class-map (queuing): q3
priority level 1
bandwidth percent 1
  output      : 0 packets, 0 bytes
  dropped     : 0 packets, 0 bytes
```

```
Class-map (queuing): q4
priority level 1
bandwidth percent 1
  output      : 0 packets, 0 bytes
  dropped     : 0 packets, 0 bytes
```

```
Class-map (queuing): q5
priority level 1
bandwidth percent 1
  output      : 0 packets, 0 bytes
  dropped     : 0 packets, 0 bytes
```

```
Class-map (queuing): q6
priority level 1
bandwidth percent 1
  output      : 0 packets, 0 bytes
  dropped     : 0 packets, 0 bytes
```

```
Class-map (queuing): q7
priority level 1
bandwidth percent 1
  output      : 1445 packets, 92536 bytes
  dropped     : 0 packets, 0 bytes
```

```
Class-map (queuing): mc-q0
  output      : 0 packets, 0 bytes
  dropped     : 0 packets, 0 bytes
```

```
Class-map (queuing): mc-q1
  output      : 0 packets, 0 bytes
  dropped     : 0 packets, 0 bytes
```

```
Class-map (queuing): mc-q2
  output      : 0 packets, 0 bytes
  dropped     : 0 packets, 0 bytes
```

```
Class-map (queuing): mc-q3
  output      : 0 packets, 0 bytes
  dropped     : 0 packets, 0 bytes
```

```
Class-map (queuing): mc-q4
  output      : 0 packets, 0 bytes
  dropped     : 0 packets, 0 bytes
```

```
Class-map (queuing): mc-q5
  output      : 0 packets, 0 bytes
  dropped     : 0 packets, 0 bytes
```

```
Class-map (queuing): mc-q6
  output      : 0 packets, 0 bytes
  dropped     : 0 packets, 0 bytes
```

```
Class-map (queuing): mc-q7
  output      : 0 packets, 0 bytes
  dropped     : 0 packets, 0 bytes
```

show qos-profile

Use this command to show the all configured QoS profiles configurations like type, name, maps configured except for the default maps, attached info (to how many interfaces it is attached) etc,

Command Syntax

```
show qos-profile (type (cos-to-queue | dscp-to-queue | queue-color-to-cos | queue-
  color-to-dscp | dscp-to-exp)| precedence-to-queue | queue-to-precedence |) (NAME|)
```

Parameters

cos-to-queue Profile for CoS to queue map
 dscp-to-queue Profile for DSCP to queue map
 queue-color-to-cos Profile for queue color to CoS map
 queue-color-to-dscp Profile for queue color to DSCP map
 dscp-to-exp Profile for DSCP to exp map
 exp-to-queue Profile for exp to queue map
 precedence-to-queue profile for precedence to queue map
 queue-to-precedence profile for queue to precedence map
 NAME Profile map name (maximum 32 characters)

Command Mode

Exec, config, interface, class-map, policy-map and policy-map-class

Applicability

This command was introduced in OcNOS DC version 4.2.

Examples

```
OcNOS#show qos-profile in xel
profile name: default
profile type: cos-to-queue (Ingress)
mapping:
```

INPUT				OUTPUT			
COS	DEI	Queue	Color	COS	DEI	Queue	Color
0	0	0	green	0	1	0	yellow
1	0	1	green	1	1	1	yellow
2	0	2	green	2	1	2	yellow
3	0	3	green	3	1	3	yellow
4	0	4	green	4	1	4	yellow
5	0	5	green	5	1	5	yellow
6	0	6	green	6	1	6	yellow
7	0	7	green	7	1	7	yellow

```

profile name: default
profile type: queue-color-to-cos (Egress)
Status: Inactive

```

```
mapping:
```

INPUT			OUTPUT			INPUT			OUTPUT		
Queue	Color	COS	Queue	Color	COS	Queue	Color	COS	Queue	Color	COS
0	green	0	0	yellow	0	0	red	0			
1	green	1	1	yellow	1	1	red	1			
2	green	2	2	yellow	2	2	red	2			
3	green	3	3	yellow	3	3	red	3			
4	green	4	4	yellow	4	4	red	4			
5	green	5	5	yellow	5	5	red	5			
6	green	6	6	yellow	6	6	red	6			
7	green	7	7	yellow	7	7	red	7			

show qos-profile interface

Use this command to show the all configured QoS profiles configurations attached on an interface.

Command Syntax

```
show qos-profile interface NAME
```

Parameters

NAME Profile map name (maximum 32 characters)

Command Mode

Exec, config, interface, class-map, policy-map and policy-map-class

Applicability

This command was introduced in OcNOS-SP version 1.0.

Examples

```
(config)#show qos-profile interface xell
profile name: cos-map
profile type: cos-to-queue
mapping:
qos profile cos-to-queue cos-map
cos 0 dei 0 queue 0 color green
cos 0 dei 1 queue 0 color yellow
cos 0 queue 0
cos 1 dei 0 queue 1 color green
cos 1 dei 1 queue 1 color yellow
cos 1 queue 1
cos 2 dei 0 queue 2 color green
cos 2 dei 1 queue 2 color yellow
cos 2 queue 2
cos 3 dei 0 queue 3 color green
cos 3 dei 1 queue 3 color yellow
cos 3 queue 3
cos 4 dei 0 queue 4 color green
cos 4 dei 1 queue 4 color yellow
cos 4 queue 4
cos 5 dei 0 queue 5 color green
cos 5 dei 1 queue 5 color yellow
cos 5 queue 5
cos 6 dei 0 queue 6 color green
```

show queuing interface

Use this command to display the configurations of queues attached to an interface.

Command Syntax

```
show queuing interface NAME
```

Parameters

NAME Interface name.

Command Mode

Exec & config mode

Applicability

This command was introduced before OcNOS version 1.3.

Examples

```
# show queuing interface xe1/1
Egress Queuing for Ethernet xe1/1 [System]
```

```
-----
L0                L1                L2                Group PrioLevel  Shape Bandwidth
-----
q0                -                High              - -
q1                -                High              - -
q2                -                High              - -
q3                -                High              - -
q4                -                High              - -
q5                -                High              - -
q6                -                High              - -
q7                -                High              - -
```

show running-config qos

Use this command to show the user configured QoS configurations.

Command Syntax

```
show running-config qos (all|)
```

Parameters

all Show all QoS related configuration information including all defaults.

Command Mode

Exec, config, interface, class-map, policy-map and policy-map-class

Applicability

This command was introduced before OcNOS version 1.3.

Examples

```
#show running-config qos
qos enable
!
!
#show running-config qos ?
  all  diplay all qos info including defaults
  |    Output modifiers
  >   Output redirection
  <cr>
```

```
#show running-config qos all
qos enable
!
qos profile cos-to-queue default
cos 0 dei 0 queue 0 color green
cos 0 dei 1 queue 0 color yellow
cos 0 queue 0
cos 1 dei 0 queue 1 color green
cos 1 dei 1 queue 1 color yellow
cos 1 queue 1
cos 2 dei 0 queue 2 color green
cos 2 dei 1 queue 2 color yellow
cos 2 queue 2
cos 3 dei 0 queue 3 color green
cos 3 dei 1 queue 3 color yellow
cos 3 queue 3
cos 4 dei 0 queue 4 color green
cos 4 dei 1 queue 4 color yellow
cos 4 queue 4
cos 5 dei 0 queue 5 color green
cos 5 dei 1 queue 5 color yellow
cos 5 queue 5
cos 6 dei 0 queue 6 color green
cos 6 dei 1 queue 6 color yellow
cos 6 queue 6
```

```
cos 7 dei 0 queue 7 color green
cos 7 dei 1 queue 7 color yellow
cos 7 queue 7
!
qos profile queue-color-to-cos default
queue 0 color green cos 0
queue 0 color yellow cos 0
queue 0 color red cos 0
queue 0 color all cos 0
queue 1 color green cos 1
queue 1 color yellow cos 1
queue 1 color red cos 1
queue 1 color all cos 1
queue 2 color green cos 2
queue 2 color yellow cos 2
queue 2 color red cos 2
queue 2 color all cos 2
queue 3 color green cos 3
queue 3 color yellow cos 3
queue 3 color red cos 3
queue 3 color all cos 3
queue 4 color green cos 4
queue 4 color yellow cos 4
queue 4 color red cos 4
queue 4 color all cos 4
queue 5 color green cos 5
queue 5 color yellow cos 5
queue 5 color red cos 5
queue 5 color all cos 5
queue 6 color green cos 6
queue 6 color yellow cos 6
queue 6 color red cos 6
queue 6 color all cos 6
queue 7 color green cos 7
queue 7 color yellow cos 7
queue 7 color red cos 7
queue 7 color all cos 7
!
qos profile dscp-to-queue default
dscp 0 queue 0 color green
dscp 1 queue 0 color green
dscp 2 queue 0 color green
dscp 3 queue 0 color green
dscp 4 queue 0 color green
dscp 5 queue 0 color green
dscp 6 queue 0 color green
dscp 7 queue 0 color green
dscp 8 queue 1 color green
dscp 9 queue 1 color green
dscp 10 queue 1 color green
dscp 11 queue 1 color green
dscp 12 queue 1 color yellow
dscp 13 queue 1 color green
dscp 14 queue 1 color red
dscp 15 queue 1 color green
dscp 16 queue 2 color green
dscp 17 queue 2 color green
```

Quality of Service Commands

```
dscp 18 queue 2 color green
dscp 19 queue 2 color green
dscp 20 queue 2 color yellow
dscp 21 queue 2 color green
dscp 22 queue 2 color red
dscp 23 queue 2 color green
dscp 24 queue 3 color green
dscp 25 queue 3 color green
dscp 26 queue 3 color green
dscp 27 queue 3 color green
dscp 28 queue 3 color yellow
dscp 29 queue 3 color green
dscp 30 queue 3 color red
dscp 31 queue 3 color green
dscp 32 queue 4 color green
dscp 33 queue 4 color green
dscp 34 queue 4 color green
dscp 35 queue 4 color green
dscp 36 queue 4 color yellow
dscp 37 queue 4 color green
dscp 38 queue 4 color red
dscp 39 queue 4 color green
dscp 40 queue 5 color green
dscp 41 queue 5 color green
dscp 42 queue 5 color green
dscp 43 queue 5 color green
dscp 44 queue 5 color green
dscp 45 queue 5 color green
dscp 46 queue 5 color green
dscp 47 queue 5 color green
dscp 48 queue 6 color green
dscp 49 queue 6 color green
dscp 50 queue 6 color green
dscp 51 queue 6 color green
dscp 52 queue 6 color green
dscp 53 queue 6 color green
dscp 54 queue 6 color green
dscp 55 queue 6 color green
dscp 56 queue 7 color green
dscp 57 queue 7 color green
dscp 58 queue 7 color green
dscp 59 queue 7 color green
dscp 60 queue 7 color green
dscp 61 queue 7 color green
dscp 62 queue 7 color green
dscp 63 queue 7 color green
!
qos profile queue-color-to-dscp default
queue 0 color green dscp 0
queue 0 color yellow dscp 0
queue 0 color red dscp 0
queue 0 color all dscp 0
queue 1 color green dscp 10
queue 1 color yellow dscp 12
queue 1 color red dscp 14
queue 1 color all dscp 8
queue 2 color green dscp 18
```

```
queue 2 color yellow dscp 20
queue 2 color red dscp 22
queue 2 color all dscp 16
queue 3 color green dscp 26
queue 3 color yellow dscp 28
queue 3 color red dscp 30
queue 3 color all dscp 24
queue 4 color green dscp 34
queue 4 color yellow dscp 36
queue 4 color red dscp 38
queue 4 color all dscp 32
queue 5 color green dscp 40
queue 5 color yellow dscp 40
queue 5 color red dscp 40
queue 5 color all dscp 40
queue 6 color green dscp 48
queue 6 color yellow dscp 48
queue 6 color red dscp 48
queue 6 color all dscp 48
queue 7 color green dscp 56
queue 7 color yellow dscp 56
queue 7 color red dscp 56
queue 7 color all dscp 56
!
policy-map type queuing default default-out-policy
  class type queuing default q0
    priority
    exit
  class type queuing default q1
    priority
    exit
class type queuing default q2
  priority
  exit
class type queuing default q3
  priority
  exit
class type queuing default q4
  priority
  exit
class type queuing default q5
  priority
  exit
class type queuing default q6
  priority
  exit
class type queuing default q7
  priority
  exit
!
interface xe1/1
  service-policy type queuing default default-out-policy
!
interface xe1/2
  service-policy type queuing default default-out-policy
!
interface xe1/3
```

```
service-policy type queuing default default-out-policy
!  
interface xe1/4  
service-policy type queuing default default-out-policy  
!  
interface xe2/1  
service-policy type queuing default default-out-policy
```

show running-config cpu-queue

Use this command to display details about CPU queue information based on processes running.

Command Syntax

```
show running-config cpu-queue
```

Parameters

None

Command Mode

Exec mode

Applicability

This command was introduced before OcNOS version 1.3.8

Example

```
#show running-config | in cpu-queue
cpu-queue sflow rate 10000 no-monitor
cpu-queue ospf rate 0 lossy monitor
cpu-queue nd rate 200 lossless monitor
cpu-queue arp rate 100 lossy no-monitor
cpu-queue bpdu rate 1000 monitor
```

storm-control

Use this command to set the rising threshold level for broadcast, multicast, or destination lookup failure traffic. The storm control action occurs when traffic utilization reaches this level.

Storm control is used to block the forwarding of unnecessary flooded traffic. A packet storm occurs when a large number of broadcast packets are received on a port. Forwarding these packets can cause the network to slow down or time out.

Use the `no` form of this command to disable storm control.

Command Syntax

```
storm-control (broadcast|multicast|dlf) (level LEVEL | <0-1000000000>
(kbps|mbps|gbps) burst-size <32-16M>)
no storm-control (broadcast|multicast|dlf)
```

Parameters

<code>broadcast</code>	Broadcast rate limiting.
<code>multicast</code>	Multicast rate limiting.
<code>dlf</code>	Destination lookup failure limiting.
<code>level</code>	Sets the percentage of the threshold.
<code>LEVEL</code>	The percentage of the threshold; percentage of the maximum speed (pps) of the interface <0.0000-1000.0000>.
<code><0-1000000000></code>	Sets absolute threshold value <0-1000000000>
<code>kbps</code>	specifies the units of Kilobits per second.
<code>mbps</code>	specifies the units of Megabits per second.
<code>gbps</code>	specifies the units of Gigabits per second.
<code>burst-size</code>	Set burst size
<code><32-16M></code>	value of burst in kbps

Default

By default, storm control is disabled

Command Mode

Interface mode

Applicability

This command was introduced in OcNOS-SP version 1.0.

Examples

```
#configure terminal
(config)#interface xe1
(config-if)#storm-control broadcast level 30
```



```
(config)#interface xe2
(config-if)#storm-control multicast level 30

(config)#interface xe3
(config-if)#storm-control multicast 300 mbps

(config)#interface xe4
(config-if)#no storm-control multicast
```

trust dscp

Use this command to use dscp value to decide queue mapping for packets in Layer 2 interfaces.

The no parameter with this command un-sets trust dscp.

Command Syntax

```
trust dscp
no trust dscp
```

Parameters

None

Default

By default, trust dscp is disabled on L2 interface

Command Mode

Interface mode

Applicability

This command was introduced before OcNOS version 1.3.

Examples

```
#configure terminal
(config)#int xe1/1
(config-if)#trust dscp
```

wrr-queue weight

Use this command to set wrr-queue weight for a queue.

Use the priority command to un-set configured wrr configuration.

Command Syntax

```
wrr-queue weight <1-127>
```

Parameters

<1-127> wrr queue weight to be configured.

Default

No default value is specified

Command Mode

Policy-class-map queuing Mode

Applicability

This command was introduced before OcNOS version 1.3.

Examples

```
(config)#policy-map type queuing default default-out-policy
(config-pmap-que-def)# class type queuing default q0
(config-pmap-c-que-def)#wrr-queue weight 2
(config-pmap-c-que-def)#priority
```

Index

B

Bandwidth Configuration 79
 begin modifier 14
 BGP community value
 command syntax 12
 braces
 command syntax 11

C

class map 25
 criteria 25
 class type qos 190
 class type queuing 191
 classification 24
 command abbreviations 10
 command completion 10
 command line
 errors 10
 help 9
 keyboard operations 13
 command modes 17
 configure 17
 exec 17
 interface 17
 privileged exec 17
 router 17
 command negation 11
 command syntax
 ? 12
 . 12
 () 11
 {} 11
 | 11
 A.B.C.D/M 12
 AA:NN 12
 BGP community value 12
 braces 11
 conventions 11
 curly brackets 11
 HH:MM:SS 12
 IFNAME 12
 interface name 12
 IPv4 address 12
 IPv6 address 12
 LINE 12
 lowercase 11
 MAC address 12
 monospaced font 11
 numeric range 12
 parentheses 11
 parenteses 11
 period 12
 question mark 12

square brackets 12
 time 12
 uppercase 11
 variable placeholders 12
 vertical bars 11
 WORD 12
 X:X::X:X 12
 X:X::X:X/M 12
 XX:XX:XX:XX:XX:XX 12
 configure
 QoS 23
 configure mode 17
 CoS to Queue Map Configuration 33, 37, 39
 CoS value 23
 curly brackets
 command syntax 11

D

DiffServ architecture 23
 DSCP to Queue Map Configuration 29
 DSCP value
 Differentiated Services Code Point 24

E

Enable/Disable Configuration 26
 exec command mode 17

H

Hierarchical Queuing Configuration 119, 163, 165, 173

I

IFNAME 12
 interface mode 17
 IPv4 address
 command syntax 12
 IPv6 address
 command syntax 12

L

LINE 12

M

MAC address
 command syntax 12
 Marking/Remarking Configuration 57
 match cos 211
 match dscp 208
 match ip rtp 208
 match mac 206
 match protocol 208
 match vlan 211

P

- parantheses
 - command syntax 11
- parentheses
 - command syntax 11
- period
 - command syntax 12
- policer
 - attributes 24
 - types
 - aggregate 24
 - individual 24
- policing 24
- Policing Configuration 71
- policy traffic-type 226
- policy-map 216
- priority 218
- Priority Configuration 95
- privileged exec mode 17

Q

- QoS
 - functionality 23
 - terminology 23
- qos statistics 226
- QoS Statistics Configuration 27
- question mark
 - command syntax 12
- queue-limit 227

R

- router mode 17

S

- scheduling
 - SP 25
 - WRR 25
 - WRR with SP 25
- service-policy 230
- service-policy type qos 231
- set bridge cos 233
- set precedence 240
- Shaping Configuration 87
- show commands 14
 - exclude modifier 15
 - include modifier 15
 - redirect modifier 16
- show policy-map 249
- show policy-map interface 251
- square brackets
 - command syntax 12

T

- Tail-Drop Configuration 109
- time
 - command syntax 12
- Trust DSCP on Layer 2 Interface Configuration 41, 43

V

- vertical bars
 - command syntax 11

W

- Weights for Queues Configuration 47
- WORD 12
- WRED Configuration 103