



**OcNOS®**

**Open Compute  
Network Operating System  
for Data Centers  
Version 6.4.2**

**Layer 2 Guide**

**June 2024**

---

© 2024 IP Infusion Inc. All Rights Reserved.

This documentation is subject to change without notice. The software described in this document and this documentation are furnished under a license agreement or nondisclosure agreement. The software and documentation may be used or copied only in accordance with the terms of the applicable agreement. No part of this publication may be reproduced, stored in a retrieval system, or transmitted in any form or any means electronic or mechanical, including photocopying and recording for any purpose other than the purchaser's internal use without the written permission of IP Infusion Inc.

IP Infusion Inc.  
3965 Freedom Circle, Suite 200  
Santa Clara, CA 95054  
+1 408-400-1900  
<http://www.ipinfusion.com/>

For support, questions, or comments via E-mail, contact:  
[support@ipinfusion.com](mailto:support@ipinfusion.com)

Trademarks:  
IP Infusion, OcNOS, VirNOS, ZebM, and ZebOS-XP are trademarks or registered trademarks of IP Infusion. All other trademarks, service marks, registered trademarks, or registered service marks are the property of their respective owners.

Use of certain software included in this equipment is subject to the IP Infusion, Inc. End User License Agreement at <http://www.ipinfusion.com/license>. By using the equipment, you accept the terms of the End User License Agreement.

---

# Contents

---

<b>Preface</b> .....	<b>xv</b>
IP Maestro Support .....	xv
Audience .....	xv
Conventions .....	xv
Chapter Organization .....	xv
Related Documentation .....	xv
Migration Guide .....	xvi
Feature Availability .....	xvi
Support .....	xvi
Comments .....	xvi
<b>Command Line Interface</b> .....	<b>15</b>
Overview .....	15
Command Line Interface Help .....	15
Command Completion .....	16
Command Abbreviations .....	16
Command Line Errors .....	16
Command Negation .....	17
Syntax Conventions .....	17
Variable Placeholders .....	18
Command Description Format .....	19
Keyboard Operations .....	19
Show Command Modifiers .....	20
String Parameters .....	23
Command Modes .....	23
Transaction-based Command-line Interface .....	25
<b>Layer 2 Configuration Guide</b> .....	<b>27</b>
CHAPTER 1 802.1X Configuration .....	29
Topology .....	29
Configuration .....	30
Validation .....	30
CHAPTER 2 Disabling Native VLAN Configuration .....	33
Topology .....	33
Configuration .....	33
Validation .....	34
Configuring acceptable-frame-type vlan-tagged on ingress interface .....	35
CHAPTER 3 Disabling Native VLAN Configuration on Trunk mode .....	37
Topology .....	37
Configuration .....	37
Configuring Disable-Native-VLAN on Trunk mode .....	39

CHAPTER 4	Disable Spanning Tree Configuration	41
	Disabling MSTP Configuration	41
	STP Configuration	46
	RSTP Configuration	49
CHAPTER 5	Layer 2 Control Protocols Tunneling	53
	Overview	53
	L2CP Tunneling for Provider Bridging	53
	L2CP Tunneling for VPLS/VPWS/Hybrid (Bridge+VPWS)	54
	L2CP Tunneling for VXLAN	54
	L2CP Behavior	55
	Default L2CP configuration	56
	Operational Concepts and Scenarios	57
CHAPTER 6	Link Aggregation Configuration	61
	Topology	61
	Dynamic LAG Configuration	61
	Static LAG Configuration	64
	Static LAG Minimum Link Configuration	66
	Static-LAG Minimum Bandwidth Configuration	68
	Dynamic-LAG Minimum Link Configuration	71
	Dynamic LAG Minimum Bandwidth Configuration	75
	LACP Minimum-Link, Minimum-Bandwidth Configurations on dynamic, static Channel-Groups with MLAG	78
	LACP Force-Up	90
	Validation	93
	LACP force-up with McLAG	96
	Validation	100
CHAPTER 7	Link Layer Discovery Protocol Configuration	107
	Topology	107
	LLDPv2 (Interface Mode TLV)	107
	LLDPV2 (Global Mode TLV)	114
	LLDP-MED	116
CHAPTER 8	MLAG Configuration	125
	Dynamic Configuration	125
	Static Configuration	134
	ARP ACL Configuration	143
	Disabling STP for MLAG	150
	Port-isolation for MLAG	154
CHAPTER 9	MSTP Configuration	163
	Configuration	163
CHAPTER 10	Port Security Configuration	179
	Secured MACs Learned Dynamically	179
	Secured MAC Addresses Learned Statically	182
	Static Mode	183

---

Port Security using MLAG.....	186
CHAPTER 11 Traffic Segmentation-Protected Port.....	193
Topology.....	193
Isolated-Promiscuous Configuration.....	193
Validation.....	194
Isolated-Isolated Configuration.....	197
Validation.....	197
CHAPTER 12 RPVST+ Configuration.....	201
Topology.....	201
Configuration.....	201
CHAPTER 13 RSTP Configuration.....	207
Configuration.....	207
CHAPTER 14 Spanning Tree Protocol Configuration.....	217
Configurations.....	217
CHAPTER 15 VLAN Configuration.....	225
Configuring VLAN Tags.....	225
CHAPTER 16 VLAN Cross-Connect (XC).....	233
Overview.....	233
Topology.....	233
Configuration - Single-tagged VLAN.....	234
Double-tagged VLAN.....	237
CHAPTER 17 MAC Authentication Bypass.....	241
CHAPTER 18 Unidirectional Link Detection Configuration.....	245
Overview.....	245
CHAPTER 19 Provider Bridging Configuration.....	249
Single Provider Bridge Configuration.....	249
Two Provider Bridge Configuration.....	252
Layer 2 Protocol Tunneling (L2PT/L2CP Tunneling).....	257
Provider Bridging with VLAN Translation.....	259
Provider Bridging QoS Configuration.....	271
Provider Bridging Untagged-pep Configuration.....	280
CHAPTER 20 Provider Bridging Configuration (SVLAN).....	285
Customer-Network Port (CNP).....	285
STAG-based Interface.....	285
Port-based Interface.....	285
Topology.....	286
Configuration.....	286
Validation.....	288
CHAPTER 21 MLAG with Provider Bridging Configuration.....	289
L2CP with MLAG-Provider Bridging Configuring.....	304

CHAPTER 22	IGMP Snooping for Provider Bridge .....	307
<b>Data Center Bridging Configuration Guide .....</b>		<b>309</b>
CHAPTER 1	Priority-based Flow Control Configuration .....	311
	Configuring a Bridge and Interface for PFC .....	311
	Configuring Priorities and Link Delay Allowance for PFC .....	311
CHAPTER 2	DCBx Configuration .....	313
	Configuring ETS Parameter Exchange .....	313
	Configuring PFC Parameter Exchange .....	315
CHAPTER 3	PFC with QOS Configuration .....	319
	Topology .....	319
<b>Layer 2 Command Reference .....</b>		<b>325</b>
CHAPTER 1	Fundamental Layer 2 Commands .....	327
	errdisable cause .....	328
	errdisable link-flap-setting .....	329
	errdisable timeout .....	330
	show errdisable details .....	331
	show interface errdisable status .....	332
	show running-config switch .....	333
	show tcp .....	335
	watch static-mac-movement .....	337
CHAPTER 2	Bridge Commands .....	339
	bridge acquire .....	340
	bridge address .....	341
	bridge ageing .....	342
	bridge forward-time .....	343
	bridge hello-time .....	344
	bridge mac-priority-override .....	345
	bridge max-age .....	346
	bridge max-hops .....	347
	bridge priority .....	348
	bridge shutdown .....	349
	bridge transmit-holdcount .....	350
	bridge-group .....	351
	bridge-group path-cost .....	352
	bridge-group priority .....	353
	clear allowed-ethertype .....	354
	clear mac address-table .....	355
	dot1ad ethertype .....	357
	mac ageing display .....	358
	show allowed-ethertype .....	359
	show bridge .....	360
	show interface switchport .....	362
	show mac address-table count bridge .....	364

---

show mac address-table bridge	365
show mac-address-table bridge 1 learning	367
switchport	368
switchport allowed ethertype	369
<b>CHAPTER 3 Spanning Tree Protocol Commands</b>	<b>371</b>
bridge cisco-interoperability	373
bridge instance	374
bridge instance priority	375
bridge instance vlan	376
bridge multiple-spanning-tree	377
bridge protocol ieee	378
bridge protocol mstp	379
bridge protocol rstp	380
bridge provider-rstp	381
bridge rapid-spanning-tree	382
bridge region	383
bridge revision	384
bridge spanning-tree	385
bridge spanning-tree errdisable-timeout	386
bridge spanning-tree force-version	387
bridge spanning-tree pathcost	388
bridge spanning-tree portfast	389
bridge te-msti	390
bridge te-msti vlan	391
bridge-group instance	392
bridge-group instance path-cost	393
bridge-group instance priority	394
bridge-group path-cost	395
bridge-group priority	396
bridge-group spanning-tree	397
clear spanning-tree detected protocols	398
clear spanning-tree statistics	399
customer-spanning-tree customer-edge path-cost	400
customer-spanning-tree customer-edge priority	401
customer-spanning-tree forward-time	402
customer-spanning-tree hello-time	403
customer-spanning-tree max-age	404
customer-spanning-tree priority	405
customer-spanning-tree provider-edge path-cost	406
customer-spanning-tree provider-edge priority	407
customer-spanning-tree transmit-holdcount	408
debug mstp	409
show debugging mstp	411
show spanning-tree	412
show spanning-tree mst	416
show spanning-tree statistics	418

---

snmp restart mstp . . . . .	421
spanning-tree autoedge . . . . .	422
spanning-tree edgeport . . . . .	423
spanning-tree guard . . . . .	424
spanning-tree instance restricted-role . . . . .	425
spanning-tree instance restricted-tcn . . . . .	426
spanning-tree link-type . . . . .	427
spanning-tree mst configuration . . . . .	428
spanning-tree bpdu-filter . . . . .	429
spanning-tree bpdu-guard . . . . .	430
spanning-tree restricted-domain-role . . . . .	431
spanning-tree restricted-role . . . . .	432
spanning-tree restricted-tcn . . . . .	433
spanning-tree te-msti configuration . . . . .	434
storm-control . . . . .	435
show strom-control . . . . .	438
<b>CHAPTER 4 RPVST+ Commands . . . . .</b>	<b>439</b>
bridge vlan . . . . .	440
bridge vlan priority . . . . .	441
bridge-group vlan . . . . .	442
bridge protocol rpvst+ . . . . .	443
bridge rapid-pervlan-spanning-tree . . . . .	444
show spanning-tree rpvst+ . . . . .	445
spanning-tree rpvst+ configuration . . . . .	449
spanning-tree vlan restricted-role . . . . .	450
spanning-tree vlan restricted-tcn . . . . .	451
<b>CHAPTER 5 Link Aggregation Commands . . . . .</b>	<b>453</b>
channel-group mode . . . . .	454
clear lacp . . . . .	456
debug lacp . . . . .	457
interface po . . . . .	458
interface sa . . . . .	459
lacp destination-mac . . . . .	460
lacp force-up . . . . .	461
lacp port-priority . . . . .	462
lacp system-priority . . . . .	463
lacp timeout . . . . .	464
port-channel load-balance . . . . .	465
port-channel min-bandwidth - dynamic LAG min-bandwidth . . . . .	466
port-channel min-links - dynamic LAG min-links . . . . .	467
port-channel min-bandwidth - static LAG min-bandwidth . . . . .	468
port-channel min-links - static LAG min-links . . . . .	469
show debugging lacp . . . . .	470
show etherchannel . . . . .	471
show lacp sys-id . . . . .	474
show lacp-counter . . . . .	475



---

show port etherchannel	476
show static-channel load-balance	479
snmp restart lacp	480
static-channel-group	481
CHAPTER 6 Multi-Chassis Link Aggregation Commands	483
clear mcec statistics	484
debug mcec	485
domain-address	486
domain hello timeout	487
domain priority	488
domain-system-number	489
idl-higig	490
intra-domain-peer	491
mcec domain configuration	492
mlag	493
mode	494
show mcec statistics	495
show mlag detail	497
show mlag domain	499
show mlag stp-synchronization status	502
show spanning-tree mlag operational-config	503
show spanning-tree mlag sync-detail	504
switchover type	505
CHAPTER 7 VLAN and Private VLAN Commands	507
show dtag vlan	508
show vlan access-map	509
show vlan	510
show vlan brief	512
show vlan classifier	513
show vlan-reservation	515
switchport access	517
switchport hybrid	518
switchport mode	520
switchport mode access ingress-filter	521
switchport mode hybrid acceptable-frame-type	522
switchport mode hybrid ingress-filter	523
switchport mode trunk ingress-filter	524
switchport trunk allowed	525
switchport trunk allowed vlan dtag	527
switchport mode (trunk) disable-native-vlan	528
switchport trunk native	529
feature vlan classifier	530
vlan classifier activate	531
vlan classifier group	532
vlan classifier rule ipv4	533
vlan classifier rule mac	534

---

vlan classifier rule proto . . . . .	535
vlan database . . . . .	537
vlan-reservation. . . . .	538
vlan VLAN_RANGE bridge . . . . .	539
vlan VLAN_RANGE type customer . . . . .	540
vlan VLAN_RANGE type service . . . . .	541
CHAPTER 8    802.1x Commands . . . . .	543
auth-mac . . . . .	544
auth-mac mode . . . . .	545
auth-mac dynamic-vlan-creation . . . . .	546
auth-mac mac-aging. . . . .	547
auth-mac system-auth-ctrl. . . . .	548
auth-port. . . . .	549
debug dot1x. . . . .	550
dot1x port-control . . . . .	551
dot1x protocol-version . . . . .	552
dot1x quiet-period . . . . .	553
dot1x reauthMax . . . . .	554
dot1x reauthentication . . . . .	555
dot1x system-auth-ctrl . . . . .	556
dot1x timeout re-authperiod . . . . .	557
dot1x timeout server-timeout. . . . .	558
dot1x timeout supp-timeout. . . . .	559
dot1x timeout tx-period . . . . .	560
ip radius source-interface . . . . .	561
key-string . . . . .	562
key-string encrypted. . . . .	563
radius-server dot1x host . . . . .	564
retransmit. . . . .	565
show debugging dot1x. . . . .	566
show dot1x. . . . .	567
timeout . . . . .	570
CHAPTER 9    Link Layer Discovery Protocol Commands . . . . .	571
lldp debug . . . . .	572
lldp ip . . . . .	573
lldp run . . . . .	574
lldp tlv . . . . .	575
lldp tlv-select . . . . .	576
set lldp chassis-id-tlv . . . . .	578
set lldp disable. . . . .	579
set lldp enable. . . . .	580
set lldp locally-assigned. . . . .	581
set lldp management-address-tlv . . . . .	582
set lldp msg-tx-hold . . . . .	583
set lldp timer . . . . .	584
set lldp too-many-neighbors . . . . .	585

---

show lldp	586
snmp restart lldp	587
<b>CHAPTER 10 Link Layer Discovery Protocol v2 Commands</b>	<b>589</b>
clear lldp counters	590
lldp-agent	591
lldp debug	592
lldp run	593
set lldp agt-circuit-id	594
set lldp enable	595
set lldp chassis-id-tlv	596
set lldp chassis locally-assigned	597
set lldp disable	598
set lldp locally-assigned	599
set lldp management-address-tlv	600
set lldp med-devtype	601
set lldp msg-tx-hold	602
set lldp port-id-tlv	603
set lldp timer	604
set lldp too-many-neighbors	606
lldp tlv-select	607
lldp tlv-select med	608
lldp tlv-select basic-mgmt	609
lldp tlv-select ieee-8021-org-specific	610
lldp tlv-select ieee-8023-org-specific	611
set lldp system-description	612
set lldp system-name	613
set lldp tx-fast-init	614
set lldp tx-max-credit	615
show debugging lldp	616
show lldp neighbors	617
show lldp interface	620
snmp restart lldp	622
<b>CHAPTER 11 Port Security Commands</b>	<b>623</b>
port-security	624
show port-security	625
switchport port-security	626
switchport port-security logging	627
switchport port-security mac-address	628
switchport port-security maximum	630
<b>CHAPTER 12 VLAN Cross-Connect Commands</b>	<b>631</b>
cross-connect	632
disable	633
outer-vlan VLAN_RANGE2 (inner-vlan VLAN_RANGE2  )	635
show cross-connect	636

---

CHAPTER 12	Unidirectional Link Detection Commands	637
	udld	638
	udld message-time	639
	udld mode	640
	udld state	641
	show udld	642
	show udld interface	643
CHAPTER 13	Layer 2 Control Protocols Tunneling Commands	645
	clear l2protocol interface counters	646
	l2protocol	647
	l2protocol encapsulation dest-mac	648
	show l2protocol interface counters	649
	show l2protocol processing interface	650
CHAPTER 14	Provider Bridging Commands	651
	bridge protocol provider-mstp	652
	bridge protocol provider-rstp	653
	cvlan registration table	654
	cvlan svlan	655
	dotad	657
	show cvlan registration table	658
	switchport customer-edge	659
	switchport customer-edge hybrid	660
	switchport customer-edge trunk	661
	switchport customer-edge vlan registration	662
	switchport customer-network allowed vlan	663
	switchport customer-network vlan	664
	switchport mode	665
	switchport mode customer-edge	666
	switchport mode customer-edge hybrid acceptable-frame-type	667
	switchport provider-network	668
	switchport provider-network isolated-vlan	669
	switchport provider-network vlan translation	670
	vlan type	672
	vlan type customer	673
<b>Data Center Bridging Command Reference</b>		<b>675</b>
CHAPTER 1	Priority-based Flow Control Commands	677
	priority-flow-control accept-peer-config	678
	priority-flow-control advertise-local-config	679
	priority-flow-control enable	680
	priority-flow-control cap	681
	priority-flow-control enable priority	682
	priority-flow-control link-delay-allowance	683
	priority-flow-control mode	684
	show priority-flow-control details	685
	show priority-flow-control statistics	687

**Index . . . . . 689**



---

# Preface

---

This guide describes how to configure OcNOS.

---

## IP Maestro Support

Monitor devices running OcNOS Release 6.3.4-70 and above using IP Maestro software.

---

## Audience

This guide is intended for network administrators and other engineering professionals who configure OcNOS.

---

## Conventions

[Table P-1](#) shows the conventions used in this guide.

**Table P-1: Conventions**

Convention	Description
<i>Italics</i>	Emphasized terms; titles of books
Note:	Special instructions, suggestions, or warnings
<code>monospaced type</code>	Code elements such as commands, parameters, files, and directories

---

## Chapter Organization

The chapters in command references are organized as described in [Command Description Format](#).

The chapters in configuration guides are organized into these major sections:

- An overview that explains a configuration in words
  - Topology with a diagram that shows the devices and connections used in the configuration
  - Configuration steps in a table for each device where the left-hand side shows the commands you enter and the right-hand side explains the actions that the commands perform
  - Validation which shows commands and their output that verify the configuration
- 

## Related Documentation

For information about installing of OcNOS, see the *Installation Guide* for your platform.

---

## Migration Guide

Check the *Migration Guide* for configuration changes to make when migrating from one version of OcNOS to another.

---

## Feature Availability

The features described in this document that are available depend upon the OcNOS SKU that you purchased. See the *Application Notes* for a description of the OcNOS SKUs.

---

## Support

For support-related questions, contact [support@ipinfusion.com](mailto:support@ipinfusion.com).

---

## Comments

If you have comments, or need to report a problem with the content, contact [techpubs@ipinfusion.com](mailto:techpubs@ipinfusion.com).



---

# Command Line Interface

---

This chapter introduces the OcNOS Command Line Interface (CLI) and how to use its features.

---

## Overview

You use the CLI to configure, monitor, and maintain OcNOS devices. The CLI is text-based and each command is usually associated with a specific task.

You can give the commands described in this manual locally from the console of a device running OcNOS or remotely from a terminal emulator such as `putty` or `xterm`. You can also use the commands in scripts to automate configuration tasks.

---

## Command Line Interface Help

You access the CLI help by entering a full or partial command string and a question mark “?”. The CLI displays the command keywords or parameters along with a short description. For example, at the CLI command prompt, type:

```
> show ?
```

The CLI displays this keyword list with short descriptions for each keyword:

```
show ?
  application-priority      Application Priority
  arp                      Internet Protocol (IP)
  bfd                      Bidirectional Forwarding Detection (BFD)
  bgp                      Border Gateway Protocol (BGP)
  bi-lsp                   Bi-directional lsp status and configuration
  bridge                   Bridge group commands
  ce-vlan                  COS Preservation for Customer Edge VLAN
  class-map                Class map entry
  cli                     Show CLI tree of current mode
  clns                    Connectionless-Mode Network Service (CLNS)
  control-adjacency       Control Adjacency status and configuration
  control-channel         Control Channel status and configuration
  cspf                    CSPF Information
  customer                Display Customer spanning-tree
  cvlan                   Display CVLAN information
  debugging               Debugging functions (see also 'undebug')
  etherchannel            LACP etherchannel
  ethernet                Layer-2
  ...
```

If you type the ? in the middle of a keyword, the CLI displays help for that keyword only.

```
> show de?
  debugging Debugging functions (see also 'undebug')
```

If you type the ? in the middle of a keyword, but the incomplete keyword matches several other keywords, OcNOS displays help for all matching keywords.

```
> show i? (CLI does not display the question mark).
interface Interface status and configuration
ip IP information
isis ISIS information
```

---

## Command Completion

The CLI can complete the spelling of a command or a parameter. Begin typing the command or parameter and then press the tab key. For example, at the CLI command prompt type `sh`:

```
> sh
```

Press the tab key. The CLI displays:

```
> show
```

If the spelling of a command or parameter is ambiguous, the CLI displays the choices that match the abbreviation. Type `show i` and press the tab key. The CLI displays:

```
> show i
  interface ip          ipv6          isis
> show i
```

The CLI displays the `interface` and `ip` keywords. Type `n` to select `interface` and press the tab key. The CLI displays:

```
> show in
> show interface
```

Type `?` and the CLI displays the list of parameters for the `show interface` command.

```
> show interface
  IFNAME  Interface name
  |       Output modifiers
  >       Output redirection
  <cr>
```

The CLI displays the only parameter associated with this command, the `IFNAME` parameter.

---

## Command Abbreviations

The CLI accepts abbreviations that uniquely identify a keyword in commands. For example:

```
> sh int xe0
```

is an abbreviation for:

```
> show interface xe0
```

---

## Command Line Errors

Any unknown spelling causes the CLI to display the error `Unrecognized command` in response to the `?`. The CLI displays the command again as last entered.

```
> show dd?
% Unrecognized command
> show dd
```

When you press the Enter key after typing an invalid command, the CLI displays:

```
(config)#router ospf here
                        ^
% Invalid input detected at '^' marker.
```

where the `^` points to the first character in error in the command.

If a command is incomplete, the CLI displays the following message:

```
> show
% Incomplete command.
```

Some commands are too long for the display line and can wrap mid-parameter or mid-keyword, as shown below. This does *not* cause an error and the command performs as expected:

```
area 10.10.0.18 virtual-link 10.10.0.19 authent
ication-key 57393
```

---

## Command Negation

Many commands have a `no` form that resets a feature to its default value or disables the feature. For example:

- The `ip address` command assigns an IPv4 address to an interface
- The `no ip address` command removes an IPv4 address from an interface

---

## Syntax Conventions

[Table P-2](#) describes the conventions used to represent command syntax in this reference.

**Table P-2: Syntax conventions**

Convention	Description	Example
monospaced font	Command strings entered on a command line	<code>show ip ospf</code>
lowercase	Keywords that you enter exactly as shown in the command syntax.	<code>show ip ospf</code>
UPPERCASE	See <a href="#">Variable Placeholders</a>	<code>IFNAME</code>
( )	Optional parameters, from which you must select one. Vertical bars delimit the selections. Do not enter the parentheses or vertical bars as part of the command.	<code>(A.B.C.D &lt;0-4294967295&gt;)</code>
( )	Optional parameters, from which you select one or none. Vertical bars delimit the selections. Do not enter the parentheses or vertical bars as part of the command.	<code>(A.B.C.D &lt;0-4294967295&gt; )</code>
( )	Optional parameter which you can specify or omit. Do not enter the parentheses or vertical bar as part of the command.	<code>(IFNAME )</code>
{ }	Optional parameters, from which you must select one or more. Vertical bars delimit the selections. Do not enter the braces or vertical bars as part of the command.	<code>{intra-area &lt;1-255&gt; inter-area &lt;1-255&gt; external &lt;1-255&gt;}</code>

**Table P-2: Syntax conventions (Continued)**

Convention	Description	Example
[ ]	Optional parameters, from which you select zero or more. Vertical bars delimit the selections. Do not enter the brackets or vertical bars as part of the command.	[<1-65535> AA:NN internet local-AS no-advertise no-export]
?	Nonrepeatable parameter. The parameter that follows a question mark can only appear once in a command string. Do not enter the question mark as part of the command.	?route-map WORD
.	Repeatable parameter. The parameter that follows a period can be repeated more than once. Do not enter the period as part of the command.	set as-path prepend .<1-65535>

---

## Variable Placeholders

Table P-3 shows the tokens used in command syntax use to represent variables for which you supply a value.

**Table P-3: Variable placeholders**

Token	Description
WORD	A contiguous text string (excluding spaces)
LINE	A text string, including spaces; no other parameters can follow this parameter
IFNAME	Interface name whose format varies depending on the platform; examples are: eth0, Ethernet0, ethernet0, xe0
A.B.C.D	IPv4 address
A.B.C.D/M	IPv4 address and mask/prefix
X:X::X:X	IPv6 address
X:X::X:X/M	IPv6 address and mask/prefix
HH:MM:SS	Time format
AA:NN	BGP community value
XX:XX:XX:XX:XX:XX	MAC address
<1-5> <1-65535> <0-2147483647> <0-4294967295>	Numeric range

---

## Command Description Format

Table P-4 explains the sections used to describe each command in this reference.

**Table P-4: Command descriptions**

Section	Description
<b>Command Name</b>	The name of the command, followed by what the command does and when should it be used
<b>Command Syntax</b>	The syntax of the command
<b>Parameters</b>	Parameters and options for the command
<b>Default</b>	The state before the command is executed
<b>Command Mode</b>	The mode in which the command runs; see <a href="#">Command Modes</a>
<b>Example</b>	An example of the command being executed

---

## Keyboard Operations

Table P-5 lists the operations you can perform from the keyboard.

**Table P-5: Keyboard operations**

Key combination	Operation
Left arrow or Ctrl+b	Moves one character to the left. When a command extends beyond a single line, you can press left arrow or Ctrl+b repeatedly to scroll toward the beginning of the line, or you can press Ctrl+a to go directly to the beginning of the line.
Right arrow or Ctrl-f	Moves one character to the right. When a command extends beyond a single line, you can press right arrow or Ctrl+f repeatedly to scroll toward the end of the line, or you can press Ctrl+e to go directly to the end of the line.
Esc, b	Moves back one word
Esc, f	Moves forward one word
Ctrl+e	Moves to end of the line
Ctrl+a	Moves to the beginning of the line
Ctrl+u	Deletes the line
Ctrl+w	Deletes from the cursor to the previous whitespace
Alt+d	Deletes the current word
Ctrl+k	Deletes from the cursor to the end of line
Ctrl+y	Pastes text previously deleted with Ctrl+k, Alt+d, Ctrl+w, or Ctrl+u at the cursor

**Table P-5: Keyboard operations (Continued)**

Key combination	Operation
Ctrl+t	Transposes the current character with the previous character
Ctrl+c	Ignores the current line and redisplay the command prompt
Ctrl+z	Ends configuration mode and returns to exec mode
Ctrl+l	Clears the screen
Up Arrow or Ctrl+p	Scroll backward through command history
Down Arrow or Ctrl+n	Scroll forward through command history

---

## Show Command Modifiers

You can use two tokens to modify the output of a `show` command. Enter a question mark to display these tokens:

```
# show users ?
  | Output modifiers
  > Output redirection
```

You can type the | (vertical bar character) to use output modifiers. For example:

```
> show rsvp | ?
begin      Begin with the line that matches
exclude    Exclude lines that match
include    Include lines that match
last       Last few lines
redirect   Redirect output
```

---

## Begin Modifier

The `begin` modifier displays the output beginning with the first line that contains the input string (everything typed after the `begin` keyword). For example:

```
# show running-config | begin xe1
...skipping
interface xe1
  ipv6 address fe80::204:75ff:fee6:5393/64
!
interface xe2
  ipv6 address fe80::20d:56ff:fe96:725a/64
!
line con 0
  login
!
end
```

You can specify a regular expression after the `begin` keyword. This example begins the output at a line with either “xe2” or “xe4”:

```
# show running-config | begin xe[3-4]
...skipping
```

```

interface xe3
 shutdown
!
interface xe4
 shutdown
!
interface svlan0.1
 no shutdown
!
route-map myroute permit 3
!
route-map mymap1 permit 10
!
route-map rmap1 permit 3
!
line con 0
 login
line vty 0 4
 login
!
end

```

---

## Include Modifier

The `include` modifier includes only those lines of output that contain the input string. In the output below, all lines containing the word “input” are included:

```

# show interface xe1 | include input
  input packets 80434552, bytes 2147483647, dropped 0, multicast packets 0
  input errors 0, length 0, overrun 0, CRC 0, frame 0, fifo 1, missed 0

```

You can specify a regular expression after the `include` keyword. This examples includes all lines with “input” or “output”:

```

#show interface xe0 | include (in|out)put
  input packets 597058, bytes 338081476, dropped 0, multicast packets 0
  input errors 0, length 0, overrun 0, CRC 0, frame 0, fifo 0, missed 0
  output packets 613147, bytes 126055987, dropped 0
  output errors 0, aborted 0, carrier 0, fifo 0, heartbeat 0, window 0

```

---

## Exclude Modifier

The `exclude` modifier excludes all lines of output that contain the input string. In the following output example, all lines containing the word “input” are excluded:

```

# show interface xe1 | exclude input
Interface xe1
Scope: both
Hardware is Ethernet, address is 0004.75e6.5393
index 3 metric 1 mtu 1500 <UP,BROADCAST,RUNNING,MULTICAST>
VRF Binding: Not bound
Administrative Group(s): None
DSTE Bandwidth Constraint Mode is MAM
inet6 fe80::204:75ff:fee6:5393/64
  output packets 4438, bytes 394940, dropped 0
  output errors 0, aborted 0, carrier 0, fifo 0, heartbeat 0, window 0
  collisions 0

```

You can specify a regular expression after the `exclude` keyword. This example excludes lines with “output” or “input”:

```
# show interface xe0 | exclude (in|out)put
Interface xe0
  Scope: both
  Hardware is Ethernet   Current HW addr: 001b.2139.6c4a
  Physical:001b.2139.6c4a Logical:(not set)
  index 2 metric 1 mtu 1500 duplex-full arp ageing timeout 3000
  <UP,BROADCAST,RUNNING,MULTICAST>
  VRF Binding: Not bound
  Bandwidth 100m
  DHCP client is disabled.
  inet 10.1.2.173/24 broadcast 10.1.2.255
  VRRP Master of : VRRP is not configured on this interface.
  inet6 fe80::21b:21ff:fe39:6c4a/64
  collisions 0
```

---

## Redirect Modifier

The `redirect` modifier writes the output into a file. The output is not displayed.

```
# show cli history | redirect /var/frame.txt
```

The output redirection token (`>`) does the same thing:

```
# show cli history >/var/frame.txt
```

---

## Last Modifier

The `last` modifier displays the output of last few number of lines (As per the user input). The last number ranges from 1 to 9999.

For example:

```
#show running-config | last 10
```



---

## String Parameters

The restrictions in [Table P-6](#) apply for all string parameters used in OcnOS commands, unless some other restrictions are noted for a particular command.

**Table P-6: String parameter restrictions**

Restriction	Description
Input length	1965 characters or less
Restricted special characters	“?”, “,”, “>”, “ ”, and “=” The “ ” is allowed only for <code>description</code> CLI in interface mode.

---

## Command Modes

Commands are grouped into modes arranged in a hierarchy. Each mode has its own set of commands. [Table P-7](#) lists the command modes common to all protocols.

**Table P-7: Common command modes**

Name	Description
Executive mode	Also called <i>view</i> mode, this is the first mode to appear after you start the CLI. It is a base mode from where you can perform basic commands such as <code>show</code> , <code>exit</code> , <code>quit</code> , <code>help</code> , and <code>enable</code> .
Privileged executive mode	Also called <i>enable</i> mode, in this mode you can run additional basic commands such as <code>debug</code> , <code>write</code> , and <code>show</code> .
Configure mode	Also called <i>configure terminal</i> mode, in this mode you can run configuration commands and go into other modes such as interface, router, route map, key chain, and address family.  Configure mode is single user. Only one user at a time can be in configure mode.
Interface mode	In this mode you can configure protocol-specific settings for a particular interface. Any setting you configure in this mode overrides a setting configured in router mode.
Router mode	This mode is used to configure router-specific settings for a protocol such as BGP or OSPF.

---

## Command Mode Tree

The diagram below shows the common command mode hierarchy.

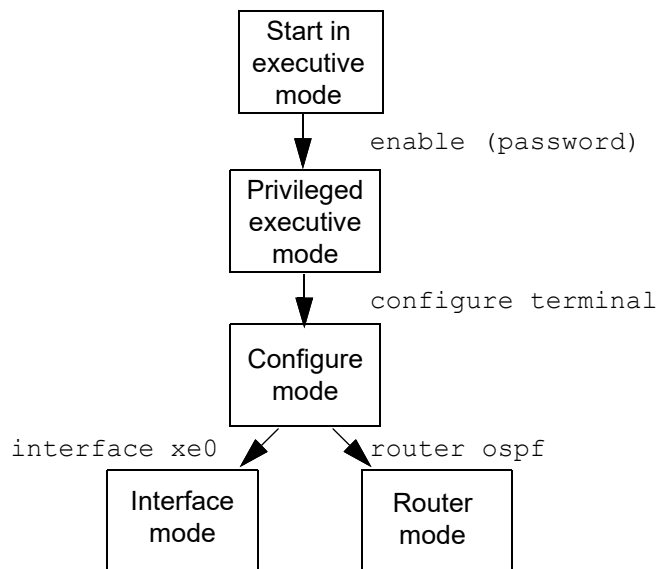

**Figure P-1: Common command modes**

To change modes:

1. Enter privileged executive mode by entering `enable` in Executive mode.
2. Enter configure mode by entering `configure terminal` in Privileged Executive mode.

The example below shows moving from executive mode to privileged executive mode to configure mode and finally to router mode:

```
> enable mypassword
# configure terminal
Enter configuration commands, one per line. End with CNTL/Z.
(config)# router ospf
(config-router)#
```

Note: Each protocol can have modes in addition to the common command modes. See the command reference for the respective protocol for details.

---

## Transaction-based Command-line Interface

The OcNOS command line interface is transaction based:

- Any changes done in configure mode are stored in a separate *candidate* configuration that you can view with the `show transaction current` command.
- When a configuration is complete, apply the candidate configuration to the running configuration with the `commit` command.
- If a `commit` fails, no configuration is applied as the entire transaction is considered failed. You can continue to change the candidate configuration and then retry the `commit`.
- Discard the candidate configuration with the `abort transaction` command.
- Check the last aborted transaction with the `show transaction last-aborted` command.
- Multiple configurations cannot be removed with a single commit. You must remove each configuration followed by a commit.

**Note:** All commands MUST be executed only in the default CML shell (`cmlsh`). If you log in as `root` and start `imish` then the system configurations will go out of sync. The `imish` shell is not supported and should not be started manually.



# Layer 2 Configuration Guide



---

## CHAPTER 1 802.1X Configuration

---

IEEE 802.1x restricts unauthenticated devices from connecting to a switch. Only after authentication is successful, traffic is allowed through the switch.

---

### Topology

In this example, a radius server keeps the client information, validating the identity of the client and updating the switch about the authentication status of the client. The switch is the physical access between the two clients and the server. It requests information from the client, relays information to the server and then back to the client. To configure 802.1x authentication, enable authentication on ports eth1 and eth2 and specify the radius server IP address and port.

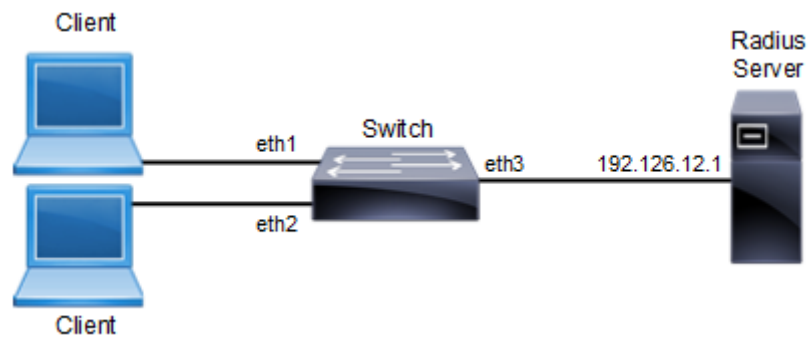

**Figure 1-1: 802.1x Topology**

---

## Configuration

---

### Switch

Switch#configure terminal	Enter configure mode.
Switch(config)#port-security disable	Disable the port-security.
Switch(config)#dot1x system-auth-ctrl	Enable authentication globally.
Switch(config)#interface eth2	Enter interface mode.
Switch(config-if)#switchport	Enable switch port on interface.
Switch(config-if)#dot1x port-control auto	Enable authentication (via Radius) on port (eth2).
Switch(config-if)#exit	Exit interface mode.
Switch(config)#interface eth1	Enter interface mode.
Switch(config-if)#switchport	Enable switch port on interface.
Switch(config-if)#dot1x port-control auto	Enable authentication (via Radius) on port (eth1).
Switch(config-if)#exit	Exit interface mode.
Switch(config)#radius-server dot1x keystring testing123	Specify the key with string name between radius server and client
Switch(config)# radius-server dot1x host 192.126.12.1	Specify the radius server address.
Switch(config-if)#commit	Commit the transaction.
Switch(config-if)#exit	Exit interface mode.
Switch(config)#interface eth3	Enter interface mode.
Switch(config-if)#ip address 192.126.12.2/24	Set the IP address on interface eth3.
Switch(config-if)#commit	Commit the transaction.
Switch(config-if)#exit	Exit interface mode.

---

## Validation

```
#show dot1x all
```

```
802.1X Port-Based Authentication Enabled RADIUS server address: 192.168.1.1:60000 Next
radius message id: 147
```

© 2021 IP Infusion Inc. Proprietary1087

```
802.1X Configuration
```

```
RADIUS client address: not configured 802.1X info for interface eth1
```

```
portEnabled: true - portControl: Auto portStatus: Unauthorized - currentId: 29 protocol
version: 2
```

```
reAuthenticate: disabled reAuthPeriod: 3600
```

```
abort:F fail:F start:F timeout:F success:F PAE: state: Connecting - portMode: Auto PAE:
reAuthCount: 1 - rxRespId: 0
```



---

```
PAE: quietPeriod: 60 - reauthMax: 2 - txPeriod: 30 BE: state: Idle - reqCount: 0 -
idFromServer: 0 BE: suppTimeout: 30 - serverTimeout: 30
CD: adminControlledDirections: in - operControlledDirections: in CD: bridgeDetected:
false
KR: rxKey: false
KT: keyAvailable: false - keyTxEnabled: false

802.1X info for interface eth2 portEnabled: true - portControl: Auto portStatus:
Unauthorized - currentId: 29 protocol version: 2
reAuthenticate: disabled reAuthPeriod: 3600
abort:F fail:F start:F timeout:F success:F PAE: state: Connecting - portMode: Auto PAE:
reAuthCount: 1 - rxRespId: 0
PAE: quietPeriod: 60 - reauthMax: 2 - txPeriod: 30 BE: state: Idle - reqCount: 0 -
idFromServer: 0 BE: suppTimeout: 30 - serverTimeout: 30
CD: adminControlledDirections: in - operControlledDirections: in CD: bridgeDetected:
false
KR: rxKey: false
KT: keyAvailable: false - keyTxEnabled: false
#show dot1x
802.1X Port-Based Authentication Enabled RADIUS server address: 192.168.1.1:60000 Next
radius message id: 147
RADIUS client address: not configured
```



## CHAPTER 2 Disabling Native VLAN Configuration

This chapter contains sample configurations to check the functionality to drop the untagged traffic by disabling the native vlan by configuring acceptable-frame-type vlan-tagged.

### Topology



Figure 2-2: Native VLAN Topology

### Configuration

#### SW1

SW1#configure terminal	Enter configuration mode
SW1(config)# bridge 1 protocol rstp vlan-bridge	Create bridge
SW1(config)#vlan database	Enter VLAN configuration mode
SW1(config-vlan)#vlan 2-10 bridge 1 state enable	Create 2-10 vlans
SW1(config-vlan)#exit	Exit VLAN configuration mode
SW1(config)#interface xe6	Enter interface configuration mode for xe6
SW1(config-if)#switchport	Configure switchport
SW1(config-if)#bridge-group 1	Associate interface with bridge-group 1
SW1(config-if)#switchport mode hybrid	Configure port mode as hybrid
SW1(config-if)# switchport hybrid allowed vlan all	Allow all the vlans on the xe6 port
SW1(config-if)#exit	Exit from interface mode
SW1(config)#interface xe21	Enter interface configuration mode for xe21
SW1(config-if)#switchport	Configure switchport
SW1(config-if)#bridge-group 1	Associate interface with bridge-group 1
SW1(config-if)#switchport mode hybrid	Configure port mode as hybrid
SW1(config-if)# switchport hybrid allowed vlan all	Allow all the vlans on the xe21 port
SW1(config-if)#exit	Exit from interface mode
SW1(config)#commit	Commit the candidate configuration to the running configuration

**SW2**

SW2#configure terminal	Enter configuration mode
SW2(config)# bridge 1 protocol rstp vlan-bridge	Create bridge
SW2(config)#vlan database	Enter VLAN configuration mode
SW2(config-vlan)#vlan 2-10 bridge 1 state enable	Create 2-10 vlans
SW2(config-vlan)#exit	Exit VLAN configuration mode
SW2(config)#interface xe6	Enter interface configuration mode for xe6
SW2(config-if)#switchport	Configure switchport
SW2(config-if)#bridge-group 1	Associate interface with bridge-group 1
SW2(config-if)#switchport mode hybrid	Configure port mode as hybrid
SW2(config-if)# switchport hybrid allowed vlan all	Allow all the vlans on the xe6 port
SW2(config-if)#exit	Exit from interface mode
SW2(config)#interface xe13	Enter interface configuration mode for xe13
SW2(config-if)#switchport	Configure switchport
SW2(config-if)#bridge-group 1	Associate interface with bridge-group 1
SW2(config-if)#switchport mode hybrid	Configure port mode as hybrid
SW2(config-if)# switchport hybrid allowed vlan all	Allow all the vlans on the xe13 port
SW2(config-if)#exit	Exit from interface mode
SW2(config)#commit	Commit the candidate configuration to the running configuration

**Validation**

Sending untagged, vlan-5 and vlan-6 traffic from ixia-1 to ixia-2. In the show bridge o/p we can see all the mac entries learnt for all the traffics.

In the show vlan brief output for default vlan interface xe21 is having port type as untagged (u).

```
SW1#show bridge
bridge 1 is running on rstp vlan-bridge
Ageout time is global and if something is configured for vxlan then it will be affected here also
```

Bridge	CVLAN	SVLAN	BVLAN	Port	MAC Address	FWD	Time-out
1	1			xe21	0000.0000.0003	1	300
1	5			xe21	0000.0000.0005	1	300
1	6			xe21	0000.0000.0006	1	300

```
SW1#sh int counters rate mbps
```

Interface	Rx mbps	Rx pps	Tx mbps	Tx pps

ce53	0.00	0	0.00	0
xe6	0.00	0	2960.63	246719
xe8	0.00	0	0.00	0
xe9	0.00	0	0.00	0
xe21	2960.63	246719	0.00	0

SW1#sh vlan brief

Bridge	VLAN ID	Name	State	H/W Status	Member ports (u)-Untagged, (t)-Tagged
1	1	default	ACTIVE	Success	xe6 (u) xe21 (u)
1	2	VLAN0002	ACTIVE	Success	xe6 (t) xe21 (t)
1	3	VLAN0003	ACTIVE	Success	xe6 (t) xe21 (t)
1	4	VLAN0004	ACTIVE	Success	xe6 (t) xe21 (t)
1	5	VLAN0005	ACTIVE	Success	xe6 (t) xe21 (t)
1	6	VLAN0006	ACTIVE	Success	xe6 (t) xe21 (t)
1	7	VLAN0007	ACTIVE	Success	xe6 (t) xe21 (t)
1	8	VLAN0008	ACTIVE	Success	xe6 (t) xe21 (t)
1	9	VLAN0009	ACTIVE	Success	xe6 (t) xe21 (t)
1	10	VLAN0010	ACTIVE	Success	xe6 (t) xe21 (t)

## Configuring acceptable-frame-type vlan-tagged on ingress interface

### SW1

SW1(config)#interface xe21	Enter interface configuration mode for xe21
SW1(config-if)# switchport mode hybrid acceptable-frame-type vlan-tagged	Configure acceptable-frame-type vlan-tagged
SW1(config-if)#exit	Exit from interface mode
SW1(config)#commit	Commit the candidate configuration to the running configuration

### Validation

After configuring acceptable-frame-type vlan-tagged, In the show bridge o/p we can see that un-tagged traffic is dropped (.0003 mac entry is not present), and traffic also getting dropped for that specific stream.

Now on show vlan brief output we can see that xe21 interface is having port type as tagged (t).

SW1#sh vlan brief

bridge 1 is running on rstp vlan-bridge

Ageout time is global and if something is configured for vxlan then it will be affected here also

Bridge	CVLAN	SVLAN	BVLAN	Port	MAC Address	FWD	Time-out
1	1			xe21	0000.0000.0001	1	300
1	5			xe21	0000.0000.0005	1	300

SW1#sh int counters rate mbps

## Disabling Native VLAN Configuration

---

Interface	Rx mbps	Rx pps	Tx mbps	Tx pps
ce53	0.00	0	0.00	0
xe6	0.00	0	1971.13	164480
xe8	0.00	0	0.00	0
xe9	0.00	0	0.00	0
xe21	2960.64	246720	0.00	0

SW1#sh vlan brief

Bridge	VLAN ID	Name	State	H/W Status	Member ports (u)-Untagged, (t)-Tagged
1	1	default	ACTIVE	Success	xe6 (u) xe21 (t)
1	2	VLAN0002	ACTIVE	Success	xe6 (t) xe21 (t)
1	3	VLAN0003	ACTIVE	Success	xe6 (t) xe21 (t)
1	4	VLAN0004	ACTIVE	Success	xe6 (t) xe21 (t)
1	5	VLAN0005	ACTIVE	Success	xe6 (t) xe21 (t)
1	6	VLAN0006	ACTIVE	Success	xe6 (t) xe21 (t)
1	7	VLAN0007	ACTIVE	Success	xe6 (t) xe21 (t)
1	8	VLAN0008	ACTIVE	Success	xe6 (t) xe21 (t)
1	9	VLAN0009	ACTIVE	Success	xe6 (t) xe21 (t)
1	10	VLAN0010	ACTIVE	Success	xe6 (t) xe21 (t)

## CHAPTER 3 Disabling Native VLAN Configuration on Trunk mode

This chapter contains sample configurations to check the functionality to drop the untagged traffic by disabling the native VLAN by configuring disable-native-VLAN.

### Topology



Figure 3-3: Native VLAN Topology

### Configuration

#### SW1

SW1#configure terminal	Enter configuration mode
SW1(config)#bridge 1 protocol mstp	Create bridge
SW1(config)#vlan database	Enter VLAN configuration mode
SW1(config-vlan)#vlan 2-10 bridge 1 state enable	Create 2-10 vlans
SW1(config-vlan)#exit	Exit VLAN configuration mode
SW1(config)#interface xe21	Enter interface configuration mode for xe21
SW1(config-if)#switchport	Configure switchport
SW1(config-if)#bridge-group 1	Associate interface with bridge-group 1
SW1(config-if)#switchport mode trunk	Configure port mode as trunk
SW1(config-if)#switchport trunk allowed vlan all	Allow all the VLANs on the xe21 port
SW1(config-if)#exit	Exit from interface mode
SW1(config)#interface xe6	Enter interface configuration mode for xe6
SW1(config-if)#switchport	Configure switchport
SW1(config-if)#bridge-group 1	Associate interface with bridge-group 1
SW1(config-if)#switchport mode trunk	Configure port mode as trunk
SW1(config-if)#switchport trunk allowed vlan all	Allow all the VLANs on the xe6 port
SW1(config-if)#exit	Exit from interface mode
SW1(config)#commit	Commit the candidate configuration to the running configuration

**SW2**

SW2#configure terminal	Enter configuration mode
SW2(config)#bridge 1 protocol rstp vlan-bridge	Create bridge
SW2(config)#vlan database	Enter VLAN configuration mode
SW2(config-vlan)#vlan 2-10 bridge 1 state enable	Create 2-10 vlans
SW2(config-vlan)#exit	Exit VLAN configuration mode
SW2(config)#interface xe6	Enter interface configuration mode for xe6
SW2(config-if)#switchport	Configure switchport
SW2(config-if)#bridge-group 1	Associate interface with bridge-group 1
SW2(config-if)#switchport mode trunk	Configure port mode as trunk
SW2(config-if)#switchport trunk allowed vlan all	Allow all the VLANs on the xe6 port
SW2(config-if)#exit	Exit from interface mode
SW2(config)#interface xe13	Enter interface configuration mode for xe13
SW2(config-if)#switchport	Configure switchport
SW2(config-if)#bridge-group 1	Associate interface with bridge-group 1
SW2(config-if)#switchport mode trunk	Configure port mode as trunk
SW2(config-if)#switchport trunk allowed vlan all	Allow all the VLANs on the xe13 port
SW2(config-if)#exit	Exit from interface mode
SW2(config)#commit	Commit the candidate configuration to the running configuration

**Validation**

Sending untagged, VLAN-5 and VLAN-6 traffic from IXIA-1 to IXIA-2. In the show bridge output we can see all the MAC entries learnt for all the traffics.

In the show vlan brief output for default VLAN interface xe21 is having port type as untagged (u).

```
SW1#show bridge
bridge 1 is running on mstp
Ageout time is global and if something is configured for vxlan then it will be affected here also
```

Bridge	CVLAN	SVLAN	BVLAN	Port	MAC Address	FWD	Time-out
1	1			xe21	0010.9400.0001	1	300

```
SW1#show interface counters rate mbps
```

Interface	Rx mbps	Rx pps	Tx mbps	Tx pps
xe21	621.21	606650	0.00	0
xe6	0.00	0	621.21	606651



```
SW1#show vlan brief
```

Bridge	VLAN ID	Name	State	H/W Status	Member ports (u)-Untagged, (t)-Tagged
1	1	default	ACTIVE	Success	xe21 (u) xe6 (u)
1	2	VLAN0002	ACTIVE	Success	xe21 (t) xe6 (t)
1	3	VLAN0003	ACTIVE	Success	xe21 (t) xe6 (t)
1	4	VLAN0004	ACTIVE	Success	xe21 (t) xe6 (t)
1	5	VLAN0005	ACTIVE	Success	xe21 (t) xe6 (t)
1	6	VLAN0006	ACTIVE	Success	xe21 (t) xe6 (t)
1	7	VLAN0007	ACTIVE	Success	xe21 (t) xe6 (t)
1	8	VLAN0008	ACTIVE	Success	xe21 (t) xe6 (t)
1	9	VLAN0009	ACTIVE	Success	xe21 (t) xe6 (t)
1	10	VLAN0010	ACTIVE	Success	xe21 (t) xe6 (t)

## Configuring Disable-Native-VLAN on Trunk mode

### SW1

SW1(config)#interface xe21	Enter interface configuration mode for xe21
SW1(config-if)#switchport mode trunk disable-native-vlan	Configure disable native VLAN on trunk mode
SW1(config-if)#exit	Exit from interface mode
SW1(config)#commit	Commit the candidate configuration to the running configuration

### Validation

After configuring disable-native-vlan, show vlan brief output we can see that xe21 interface is having port type as tagged (t).

```
SW1#show bridge
```

```
bridge 1 is running on mstp
```

Ageout time is global and if something is configured for vxlan then it will be affected here also

Bridge	CVLAN	SVLAN	BVLAN	Port	MAC Address	FWD	Time-out
1	1			xe21	0010.9400.0001	1	300

```
SW1SW1#show vlan brief
```

Bridge	VLAN ID	Name	State	H/W Status	Member ports (u)-Untagged, (t)-Tagged
1	1	default	ACTIVE	Success	xe21 (t) xe6 (u)
1	2	VLAN0002	ACTIVE	Success	xe21 (t) xe6 (t)
1	3	VLAN0003	ACTIVE	Success	xe21 (t) xe6 (t)
1	4	VLAN0004	ACTIVE	Success	xe21 (t) xe6 (t)
1	5	VLAN0005	ACTIVE	Success	xe21 (t) xe6 (t)

## Disabling Native VLAN Configuration on Trunk mode

---

```
1      6      VLAN0006      ACTIVE  Success  xe21(t) xe6(t)
1      7      VLAN0007      ACTIVE  Success  xe21(t) xe6(t)
1      8      VLAN0008      ACTIVE  Success  xe21(t) xe6(t)
1      9      VLAN0009      ACTIVE  Success  xe21(t) xe6(t)
1     10      VLAN0010      ACTIVE  Success  xe21(t) xe6(t)
```

SW1#show interface counters rate mbps

```
+-----+-----+-----+-----+
| Interface | Rx mbps | Rx pps | Tx mbps | Tx pps |
+-----+-----+-----+-----+
Xe21      864.88  844613  0.00     0
Xe6       0.00    0       0.00     0
```

SW1#show interface counters drop-stats

Interface xe21

Rx Policy Discards: 454522965

Rx EGR Port Unavail: 454522967

## CHAPTER 4 Disable Spanning Tree Configuration

This chapter describes disabling spanning tree operation on a per Multiple Spanning Tree Instance (MSTI) basis.

### Topology

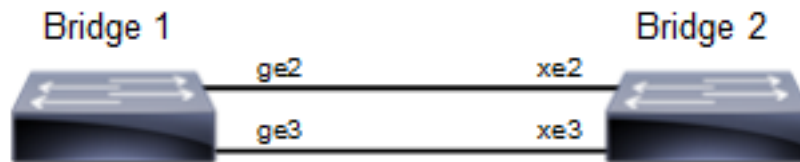

Figure 4-4: Disable Spanning Tree Topology

Note: Run the `switchport` command on each port to change to Layer-2 mode.

### Disabling MSTP Configuration

#### Bridge 1

##### Disabling MSTP per instance

<code>Bridge1(config-mst)#no bridge 1 instance 2</code>	Disable spanning tree for MSTP on instance 2
<code>Bridge1(config-mst)#no bridge 1 instance 3</code>	Disable spanning tree for MSTP on instance 3
<code>Bridge1(config-mst)#commit</code>	Commit candidate configuration to be running configuration

##### Disabling MSTP globally

<code>Bridge1(config)#no bridge 1 multiple-spanning-tree enable bridge-forward</code>	Disable spanning tree globally for MSTP and keeping the ports in forwarding state.
<code>Bridge1(config)#commit</code>	Commit candidate configuration to be running configuration

##### Disabling MSTP per port

<code>Bridge1(config)#interface ge2</code>	Enter interface mode for ge2.
<code>Bridge1(config-if)#bridge-group 1 spanning-tree disable</code>	Disable spanning tree per port for MSTP and put port on forwarding state. This command disables any type of STP on the port.
<code>Bridge1(config-if)#commit</code>	Commit candidate configuration to be running configuration

#### Bridge 2

##### Disabling MSTP per instance

<code>Bridge2(config-mst)#no bridge 1 instance 2</code>	Disable spanning tree for MSTP on instance 2
---	--

## Disable Spanning Tree Configuration

---

Bridge2(config-mst)#no bridge 1 instance 3	Disable spanning tree for MSTP on instance 3
Bridge2(config-mst)#commit	Commit candidate configuration to be running configuration

### Disabling MSTP globally

Bridge2(config)#no bridge 1 multiple-spanning-tree enable bridge-forward	Disable spanning tree globally for MSTP.
Bridge2(config)#commit	Commit candidate configuration to be running configuration

### Disabling MSTP per port

Bridge2(config)#interface xe2	Enter interface mode for xe2.
Bridge2(config-if)#bridge-group 1 spanning-tree disable	Disable spanning tree per port for MSTP and put port on forwarding state. This command disables any type of STP on the port.
Bridge2(config-if)#commit	Commit candidate configuration to be running configuration

---

## Validation

### Bridge 1

Verify MSTP details with the `show spanning-tree mst detail` command.

```
#show spanning-tree mst detail
% 1: Bridge up - Spanning Tree Enabled - topology change detected
% 1: CIST Root Path Cost 0 - CIST Root Port 905 - CIST Bridge Priority 32768
% 1: Forward Delay 15 - Hello Time 2 - Max Age 20 - Transmit Hold Count 6 -
Max-hops 20
% 1: CIST Root Id 80003417ebfbe9c4
% 1: CIST Reg Root Id 80003417ebfbe9c4
% 1: CIST Bridge Id 800064006ac779a0
% 1: 9 topology change(s) - last topology change Thu Nov 17 15:06:17 2016
% 1: portfast bpdu-filter disabled
% 1: portfast bpdu-guard disabled
% 1: portfast errdisable timeout disabled
% 1: portfast errdisable timeout interval 300 sec
% ge2: Port Number 905 - Ifindex 5001 - Port Id 0x8389 - Role Rootport -
State Forwarding
% ge2: Designated External Path Cost 0 -Internal Path Cost 20000
% ge2: Configured Path Cost 20000 - Add type Explicit ref count 2
% ge2: Designated Port Id 0x838a - CIST Priority 128 -
% ge2: CIST Root 80003417ebfbe9c4
% ge2: Regional Root 80003417ebfbe9c4
% ge2: Designated Bridge 80003417ebfbe9c4
% ge2: Message Age 0 - Max Age 20
% ge2: CIST Hello Time 2 - Forward Delay 15
% ge2: CIST Forward Timer 0 - Msg Age Timer 4 - Hello Timer 0 - topo change
timer 0
% ge2: forward-transitions 1
% ge2: Version Multiple Spanning Tree Protocol - Received MSTP - Send MSTP
% ge2: No portfast configured - Current portfast off
% ge2: bpdu-guard default - Current bpdu-guard off
% ge2: bpdu-filter default - Current bpdu-filter off
```

```

% ge2: no root guard configured - Current root guard off
% ge2: Configured Link Type point-to-point - Current point-to-point
% ge2: No auto-edge configured - Current port Auto Edge off
%
% ge3: Port Number 908 - Ifindex 5004 - Port Id 0x838c - Role Alternate -
State Discarding
% ge3: Designated External Path Cost 0 -Internal Path Cost 20000
% ge3: Configured Path Cost 20000 - Add type Explicit ref count 2
% ge3: Designated Port Id 0x838b - CIST Priority 128 -
% ge3: CIST Root 80003417ebfbe9c4
% ge3: Regional Root 80003417ebfbe9c4
% ge3: Designated Bridge 80003417ebfbe9c4
% ge3: Message Age 0 - Max Age 20
% ge3: CIST Hello Time 2 - Forward Delay 15
% ge3: CIST Forward Timer 0 - Msg Age Timer 5 - Hello Timer 1 - topo change
timer 0
% ge3: forward-transitions 2
% ge3: Version Multiple Spanning Tree Protocol - Received MSTP - Send MSTP
% ge3: No portfast configured - Current portfast off
% ge3: bpdu-guard default - Current bpdu-guard off
% ge3: bpdu-filter default - Current bpdu-filter off
% ge3: no root guard configured - Current root guard off
% ge3: Configured Link Type point-to-point - Current point-to-point
% ge3: No auto-edge configured - Current port Auto Edge off

% Instance 2: Vlans: 2

% 1: MSTI Root Path Cost 20000 -MSTI Root Port 5001 - MSTI Bridge Priority
32768
% 1: MSTI Root Id 80023417ebfbe9c4
% 1: MSTI Bridge Id 800264006ac779a0
% ge2: Port Number 905 - Ifindex 5001 - Port Id 0x8389 - Role Rootport -
State Forwarding
% ge2: Designated Internal Path Cost 0 - Designated Port Id 0x838a
% ge2: Configured Internal Path Cost 20000
% ge2: Configured CST External Path cost 20000
% ge2: CST Priority 128 - MSTI Priority 128
% ge2: Designated Root 80023417ebfbe9c4
% ge2: Designated Bridge 800264006ac779a0
% ge2: Message Age 0
% ge2: Hello Time 2 - Forward Delay 15
% ge2: Forward Timer 0 - Msg Age Timer 4 - Hello Timer 0

% Instance 3: Vlans: 3

% 1: MSTI Root Path Cost 0 -MSTI Root Port 0 - MSTI Bridge Priority 32768
% 1: MSTI Root Id 800364006ac779a0
% 1: MSTI Bridge Id 800364006ac779a0
% ge3: Port Number 908 - Ifindex 5004 - Port Id 0x838c - Role Designated -
State Forwarding
% ge3: Designated Internal Path Cost 0 - Designated Port Id 0x838c
% ge3: Configured Internal Path Cost 20000
% ge3: Configured CST External Path cost 20000
% ge3: CST Priority 128 - MSTI Priority 128
% ge3: Designated Root 800364006ac779a0
% ge3: Designated Bridge 800364006ac779a0
% ge3: Message Age 0
% ge3: Hello Time 2 - Forward Delay 15

```

```
% ge3: Forward Timer 0 - Msg Age Timer 0 - Hello Timer 1
```

Verify MSTP configurations when MSTP is enabled globally.

```
#show running-config
!
bridge 1 protocol mstp
!
```

Verify MSTP configurations when MSTP is disabled globally.

```
#show running-config
!
bridge 1 protocol mstp
no bridge 1 multiple-spanning-tree enable bridge-forward
!
```

Verify MSTP configurations when MSTP instance 2 and 3 is enabled.

```
#show running-config spanning-tree
!
spanning-tree mst configuration
bridge 1 instance 2
bridge 1 instance 2 vlan 2
bridge 1 instance 3
bridge 1 instance 3 vlan 3
!
interface xe2
bridge-group 1 instance 2
!
interface xe3
bridge-group 1 instance 3
!
```

- Verify MSTP configurations when MSTP instance 2 is disabled

```
#show running-config spanning-tree
!
spanning-tree mst configuration
bridge 1 instance 3
bridge 1 instance 3 vlan 3
!
interface ge3
bridge-group 1 instance 3
!
```

Verify MSTP configurations when spanning-tree is enabled on interface.

```
#show running-config interface ge2
!
interface ge2
switchport
bridge-group 1
switchport mode access
switchport access vlan 2
bridge-group 1 instance 2
!
```

Verify MSTP configurations when spanning-tree is disabled on interface.

```
#show running-config interface ge2
!
interface ge2
switchport
```

```
bridge-group 1 spanning-tree disable
switchport mode access
switchport access vlan 2
bridge-group 1 instance 2
```

Verify MSTP details after disabling spanning-tree on interface ge2 with the show spanning-tree mst details command.

```
#show spanning-tree mst detail
% 1: Bridge up - Spanning Tree Enabled - topology change detected
% 1: CIST Root Path Cost 0 - CIST Root Port 908 - CIST Bridge Priority 32768
% 1: Forward Delay 15 - Hello Time 2 - Max Age 20 - Transmit Hold Count 6 -
Max-hops 20
% 1: CIST Root Id 80003417ebfbe9c4
% 1: CIST Reg Root Id 80003417ebfbe9c4
% 1: CIST Bridge Id 800064006ac779a0
% 1: 10 topology change(s) - last topology change Fri Nov 25 21:21:05 2016

% 1: portfast bpdu-filter disabled
% 1: portfast bpdu-guard disabled
% 1: portfast errdisable timeout disabled
% 1: portfast errdisable timeout interval 300 sec
% ge2: Port Number 905 - Ifindex 5001 - Port Id 0x8389 - Role Disabled -
State Forwarding
% ge2: Designated External Path Cost 0 -Internal Path Cost 20000
% ge2: Configured Path Cost 20000 - Add type Explicit ref count 2
% ge2: Designated Port Id 0x838a - CIST Priority 128 -
% ge2: Message Age 0 - Max Age 20
% ge2: CIST Hello Time 2 - Forward Delay 15
% ge2: CIST Forward Timer 0 - Msg Age Timer 4 - Hello Timer 0 - topo change
timer 0
% ge2: forward-transitions 2
% ge2: Version Multiple Spanning Tree Protocol - Received MSTP - Send MSTP
% ge2: No portfast configured - Current portfast off
% ge2: bpdu-guard default - Current bpdu-guard off
% ge2: bpdu-filter default - Current bpdu-filter off
% ge2: no root guard configured - Current root guard off
% ge2: Configured Link Type point-to-point - Current point-to-point
% ge2: No auto-edge configured - Current port Auto Edge off
% ge3: Port Number 908 - Ifindex 5004 - Port Id 0x838c - Role Rootport -
State Forwarding
% ge3: Designated External Path Cost 0 -Internal Path Cost 20000
% ge3: Configured Path Cost 20000 - Add type Explicit ref count 2
% ge3: Designated Port Id 0x838b - CIST Priority 128 -
% ge3: CIST Root 80003417ebfbe9c4
% ge3: Regional Root 80003417ebfbe9c4
% ge3: Designated Bridge 80003417ebfbe9c4
% ge3: Message Age 0 - Max Age 20
% ge3: CIST Hello Time 2 - Forward Delay 15
% ge3: CIST Forward Timer 0 - Msg Age Timer 4 - Hello Timer 1 - topo change
timer 0
% ge3: forward-transitions 3
% ge3: Version Multiple Spanning Tree Protocol - Received MSTP - Send MSTP
% ge3: No portfast configured - Current portfast off
% ge3: bpdu-guard default - Current bpdu-guard off
% ge3: bpdu-filter default - Current bpdu-filter off
% ge3: no root guard configured - Current root guard off
% ge3: Configured Link Type point-to-point - Current point-to-point
```

## Disable Spanning Tree Configuration

---

```
% ge3: No auto-edge configured - Current port Auto Edge off

% Instance 2: Vlans: 2

% 1: MSTI Root Path Cost 0 -MSTI Root Port 0 - MSTI Bridge Priority 32768
% 1: MSTI Root Id 800264006ac779a0
% 1: MSTI Bridge Id 800264006ac779a0
% ge2: Port Number 905 - Ifindex 5001 - Port Id 0x8389 - Role Disabled -
State Discarding
% ge2: Designated Internal Path Cost 0 - Designated Port Id 0x8389
% ge2: Configured Internal Path Cost 20000
% ge2: Configured CST External Path cost 20000
% ge2: CST Priority 128 - MSTI Priority 128
% ge2: Designated Root 800264006ac779a0
% ge2: Designated Bridge 800264006ac779a0
% ge2: Message Age 0
% ge2: Hello Time 2 - Forward Delay 15
% ge2: Forward Timer 0 - Msg Age Timer 0 - Hello Timer 0

% Instance 3: Vlans: 3

% 1: MSTI Root Path Cost 20000 -MSTI Root Port 5004 - MSTI Bridge Priority
32768
% 1: MSTI Root Id 80033417ebfbe9c4
% 1: MSTI Bridge Id 800364006ac779a0
% ge3: Port Number 908 - Ifindex 5004 - Port Id 0x838c - Role Rootport -
State Forwarding
% ge3: Designated Internal Path Cost 0 - Designated Port Id 0x838b
% ge3: Configured Internal Path Cost 20000
% ge3: Configured CST External Path cost 20000
% ge3: CST Priority 128 - MSTI Priority 128
% ge3: Designated Root 80033417ebfbe9c4
% ge3: Designated Bridge 800364006ac779a0
% ge3: Message Age 0
% ge3: Hello Time 2 - Forward Delay 15
% ge3: Forward Timer 0 - Msg Age Timer 4 - Hello Timer 1
```

---

## STP Configuration

### Bridge 1

#### Disabling STP globally

Bridg1(config)#no bridge 1 spanning-tree enable bridge-forward	Disable spanning tree globally for STP.
Bridg1(config)#commit	Commit candidate configuration to be running configuration

#### Disabling STP per port

Bridg1(config)#interface ge2	Enter interface mode for ge2.
------------------------------	-------------------------------



Bridge1(config-if)#bridge-group 1 spanning-tree disable	Disable spanning tree per port for STP and put port on forwarding state. This command disables any type of STP on the port.
Bridge1(config)#commit	Commit candidate configuration to be running configuration

## Bridge 2

### Disabling STP globally

Bridge2(config)#no bridge 1 spanning-tree enable bridge-forward	Disable spanning tree globally for STP.
Bridge2(config)#commit	Commit candidate configuration to be running configuration

### Disabling STP per port

Bridge2(config)#interface xe2	Enter interface mode for xe2.
Bridge2(config-if)#bridge-group 1 spanning-tree disable	Disable spanning tree per port for STP and put port on forwarding state. This command disables any type of STP on the port.
Bridge2(config-if)#commit	Commit candidate configuration to be running configuration

## Validation

### Bridge 1

Verify STP details when stp is enabled globally and ge2 and ge3 are part of the bridge using the `show spanning-tree` command.

```
#show spanning-tree
% 1: Bridge up - Spanning Tree Enabled - topology change
% 1: Root Path Cost 4 - Priority 32768
% 1: Forward Delay 15 - Hello Time 2 - Max Age 20 - Transmit Hold Count 6 -
Root port 905
% 1: Root Id 80003417ebfbe9c4
% 1: Bridge Id 800064006ac779a0
% 1: 3 topology changes - last topology change Tue Nov 15 21:33:53 2016
% 1: portfast bpdu-filter disabled
% 1: portfast bpdu-guard disabled
% 1: portfast errdisable timeout disabled
% 1: portfast errdisable timeout interval 300 sec

%ge2: Port Number 905 - Ifindex 5001 - Port Id 0x8389 - path cost 4 -
designated cost 0
%ge2: Designated Port Id 0x838a - state Forwarding -Priority 128
%ge2: Designated root 80003417ebfbe9c4
%ge2: Designated Bridge 80003417ebfbe9c4
%ge2: Message Age 0 - Max Age 20
%ge2: Hello Time 2 - Forward Delay 15
%ge2: Forward Timer 0 - Msg Age Timer 18 - Hello Timer 1 - topo change timer0
%ge2: forward-transitions 1
%ge2: No portfast configured - Current portfast
%ge2: bpdu-guard default- Current bpdu-guard off
%ge2: bpdu-filter default- Current bpdu-filter off
%ge2: no root guard configured- Current root guard off
```

## Disable Spanning Tree Configuration

---

```
%ge3: Port Number 908 - Ifindex 5004 - Port Id 0x838c - path cost 4 -
designated cost 0
%ge3: Designated Port Id 0x838b - state Blocked -Priority 128
%ge3: Designated root 80003417ebfbe9c4
%ge3: Designated Bridge 80003417ebfbe9c4
%ge3: Message Age 0 - Max Age 20
%ge3: Hello Time 2 - Forward Delay 15
%ge3: Forward Timer 0 - Msg Age Timer 19 - Hello Timer 1 - topo change timer0
%ge3: forward-transitions 0
%ge3: No portfast configured - Currentportfast off
%ge3: bpdu-guarddefault- Current bpdu-guard off
%ge3: bpdu-filter default- Current bpdu-filter off
%ge3: no root guard configured- Current root guard off
%
```

Verify STP configurations when STP is enabled globally.

```
#show running-config
!
bridge 1 protocol ieee vlan-bridge
!
```

Verify STP configurations when STP is disabled globally.

```
#show running-config
!
bridge 1 protocol ieee vlan-bridge
no bridge 1 spanning-tree enable bridge-forward
!
```

Verify STP configurations when spanning-tree is enabled on interface.

```
#show running-config interface ge2
!
interface ge2
switchport
bridge-group 1
switchport mode trunk
switchport trunk allowed vlan all
!
```

Verify STP configurations when spanning-tree is disabled on interface.

```
#show running-config interface ge2
!
interface ge2
switchport
bridge-group 1 spanning-tree disable
switchport mode trunk
switchport trunk allowed vlan all
!
```

Verify STP details after disabling spanning-tree on interface ge2 with the show spanning-tree command.

```
#show spanning-tree
% 1: Bridge up - Spanning Tree Enabled
% 1: Root Path Cost 4 - Priority 32768
% 1: Forward Delay 15 - Hello Time 2 - Max Age 20 - Transmit Hold Count 6 -
Root port 908
% 1: Root Id 80003417ebfbe9c4
% 1: Bridge Id 800064006ac779a0
% 1: 5 topology changes - last topology change Fri Nov 25 21:15:35 2016
% 1: portfast bpdu-filter disabled
```

```

% 1: portfast bpdu-guard disabled
% 1: portfast errdisable timeout disabled
% 1: portfast errdisable timeout interval 300 sec
%   ge2: Port Number 905 - Ifindex 5001 - Port Id 0x8389 - path cost 4 -
designated cost 0
%   ge2: Designated Port Id 0x838a - state Disabled -Priority 128
%   ge2: Message Age 0 - Max Age 20
%   ge2: Hello Time 2 - Forward Delay 15
%   ge2: Forward Timer 0 - Msg Age Timer 18 - Hello Timer 0 - topo change
timer 23
%   ge2: forward-transitions 2
%   ge2: No portfast configured - Current portfast off
%   ge2: bpdu-guard default - Current bpdu-guard off
%   ge2: bpdu-filter default - Current bpdu-filter off
%   ge2: no root guard configured - Current root guard off
%
%   ge3: Port Number 908 - Ifindex 5004 - Port Id 0x838c - path cost 4 -
designated cost 0
%   ge3: Designated Port Id 0x838b - state Forwarding -Priority 128
%   ge3: Designated root 80003417ebfbe9c4
%   ge3: Designated Bridge 80003417ebfbe9c4
%   ge3: Message Age 0 - Max Age 20
%   ge3: Hello Time 2 - Forward Delay 15
%   ge3: Forward Timer 0 - Msg Age Timer 19 - Hello Timer 1 - topo change
timer 23
%   ge3: forward-transitions 2
%   ge3: No portfast configured - Current portfast off
%   ge3: bpdu-guard default - Current bpdu-guard off
%   ge3: bpdu-filter default - Current bpdu-filter off
%   ge3: no root guard configured - Current root guard off

```

## RSTP Configuration

### Bridge 1

#### Disabling RSTP globally

Bridgel(config)#no bridge 1 rapid-spanning-tree enable bridge-forward	Disable spanning tree globally for RSTP.
Bridgel(config)#commit	Commit candidate configuration to be running configuration

#### Disabling RSTP per port

Bridgel(config)#interface ge2	Enter interface mode for ge2.
Bridgel(config-if)#bridge-group 1 spanning-tree disable	Disable spanning tree per port for RSTP and put port on forwarding state. This command disables any type of STP on the port.
Bridgel(config-if)#commit	Commit candidate configuration to be running configuration

### Bridge 2

#### Disabling RSTP globally

Bridge2(config)#no bridge 1 rapid-spanning-tree enable bridge-forward	Disable spanning tree globally for RSTP.
Bridge2(config)#commit	Commit candidate configuration to be running configuration

#### Disabling RSTP per port

Bridge2(config)#interface xe2	Enter interface mode for xe2.
Bridge2(config-if)#bridge-group 1 spanning-tree disable	Disable spanning tree per port for RSTP and put port on forwarding state. This command disables any type of STP on the port.
Bridge2(config)#commit	Commit candidate configuration to be running configuration

---

## Validation

### Bridge 1

Verify RSTP details when rstp is enabled globally and ge2 and ge3 are part of the bridge using the `show spanning-tree` command.

```
#show spanning-tree
% 1: Bridge up - Spanning Tree Enabled- topology change detected
% 1: Root Path Cost 20000 - Root Port 905 -Bridge Priority 32768
% 1: Forward Delay 15 - Hello Time 2 - Max Age 20 - Transmit Hold Count 6
% 1: Root Id 80003417ebfbe9c4
% 1: Bridge Id 800064006ac779a0
% 1: last topology change Tue Nov 15 21:44:31 2016
% 1: 7 topology change(s)- last topology change Tue Nov 15 21:44:31 2016
% 1: portfast bpdu-filter disabled
% 1: portfast bpdu-guard disabled
% 1: portfast errdisable timeout disabled
% 1: portfast errdisable timeout interval 300 sec
% ge2: Port Number 905 - Ifindex 5001 - Port Id 0x8389 - Role Rootport - State Forwarding
% ge2: Designated Path Cost 0
% ge2: Configured Path Cost 20000- Add type Explicit ref count 1
% ge2: Designated Port Id 0x838a - Priority 128-
% ge2: Root 80003417ebfbe9c4
% ge2: Designated Bridge 80003417ebfbe9c4
% ge2: Message Age 0 - Max Age 20
% ge2: Hello Time 2 - Forward Delay 15
% ge2: Forward Timer 0 - Msg Age Timer 4 - Hello Timer 1 - topo change timer 0
% ge2: forward-transitions 1
% ge2: Version Rapid Spanning Tree Protocol - Received RSTP - Send RSTP
% ge2: No portfast configured - Currentportfast off
% ge2: bpdu-guarddefault- Current bpdu-guard off
% ge2: bpdu-filter default- Current bpdu-filter off
% ge2: no root guard configured- Current root guard off
% ge2: Configured Link Type point-to-point - Current point-to-point
% ge2: No auto-edge configured - Current port Auto Edge off
```

```

% ge3: Port Number 908 - Ifindex 5004 - Port Id 0x838c - Role Alternate -
State Discarding
% ge3: Designated Path Cost 0
% ge3: Configured Path Cost 20000- Add type Explicit ref count 1
% ge3: Designated Port Id 0x838b - Priority 128-
% ge3: Root 80003417ebfbe9c4
% ge3: Designated Bridge 80003417ebfbe9c4
% ge3: Message Age 0 - Max Age 20
% ge3: Hello Time 2 - Forward Delay 15
% ge3: Forward Timer 0 - Msg Age Timer 5 - Hello Timer 0 - topo change timer
0
% ge3: forward-transitions 2
% ge3: Version Rapid Spanning Tree Protocol - Received RSTP - Send RSTP
% ge3: No portfast configured - Currentportfast off
% ge3: bpdu-guarddefault- Current bpdu-guard off
% ge3: bpdu-filter default- Current bpdu-filter off
% ge3: no root guard configured- Current root guard off
% ge3: Configured Link Type point-to-point - Current point-to-point
% ge3: No auto-edge configured - Current port Auto Edge off
%

```

Verify RSTP configurations when RSTP is enabled globally.

```

#show running-config
!
bridge 1 protocol rstp vlan-bridge
!

```

- Verify RSTP configurations when RSTP is disabled globally

```

#show running-config
!
bridge 1 protocol rstp vlan-bridge
no bridge 1 rapid-spanning-tree enable bridge-forward
!

```

Verify RSTP configurations when spanning-tree is enabled on interface.

```

#show running-config interface ge2
!
interface ge2
switchport
bridge-group 1
switchport mode trunk
switchport trunk allowed vlan all
!

```

Verify RSTP configurations when spanning-tree is disabled on interface.

```

#show running-config interface ge2
!
interface ge2
switchport
bridge-group 1 spanning-tree disable
switchport mode trunk
switchport trunk allowed vlan all

```

Verify RSTP details after disabling spanning-tree on interface ge2 with the show spanning-tree command.

```

#sh spanning-tree
% 1: Bridge up - Spanning Tree Enabled - topology change detected
% 1: Root Path Cost 20000 - Root Port 908 - Bridge Priority 32768

```

## Disable Spanning Tree Configuration

---

```
% 1: Forward Delay 15 - Hello Time 2 - Max Age 20 - Transmit Hold Count 6
% 1: Root Id 80003417ebfbe9c4
% 1: Bridge Id 800064006ac779a0
% 1: last topology change Fri Nov 25 21:08:56 2016
% 1: 11 topology change(s) - last topology change Fri Nov 25 21:08:56 2016
% 1: portfast bpdu-filter disabled
% 1: portfast bpdu-guard disabled
% 1: portfast errdisable timeout disabled
% 1: portfast errdisable timeout interval 300 sec
% ge2: Port Number 905 - Ifindex 5001 - Port Id 0x8389 - Role Disabled -
State Forwarding
% ge2: Designated Path Cost 0
% ge2: Configured Path Cost 20000 - Add type Explicit ref count 1
% ge2: Designated Port Id 0x838a - Priority 128 -
% ge2: Message Age 0 - Max Age 20
% ge2: Hello Time 2 - Forward Delay 15
% ge2: Forward Timer 0 - Msg Age Timer 5 - Hello Timer 0 - topo change timer
0
% ge2: forward-transitions 2
% ge2: Version Rapid Spanning Tree Protocol - Received RSTP - Send RSTP
% ge2: No portfast configured - Current portfast off
% ge2: bpdu-guard default - Current bpdu-guard off
% ge2: bpdu-filter default - Current bpdu-filter off
% ge2: no root guard configured - Current root guard off
% ge2: Configured Link Type point-to-point - Current point-to-point
% ge2: No auto-edge configured - Current port Auto Edge off
%
% ge3: Port Number 908 - Ifindex 5004 - Port Id 0x838c - Role Rootport -
State Forwarding
% ge3: Designated Path Cost 0
% ge3: Configured Path Cost 20000 - Add type Explicit ref count 1
% ge3: Designated Port Id 0x838b - Priority 128 -
% ge3: Root 80003417ebfbe9c4
% ge3: Designated Bridge 80003417ebfbe9c4
% ge3: Message Age 0 - Max Age 20
% ge3: Hello Time 2 - Forward Delay 15
% ge3: Forward Timer 0 - Msg Age Timer 5 - Hello Timer 1 - topo change timer
0
% ge3: forward-transitions 3
% ge3: Version Rapid Spanning Tree Protocol - Received RSTP - Send RSTP
% ge3: No portfast configured - Current portfast off
% ge3: bpdu-guard default - Current bpdu-guard off
% ge3: bpdu-filter default - Current bpdu-filter off
% ge3: no root guard configured - Current root guard off
% ge3: Configured Link Type point-to-point - Current point-to-point
% ge3: No auto-edge configured - Current port Auto Edge off
```

## Overview

The Layer 2 Control Protocols (L2CP) processing specified here is based largely on the IEEE 802.1Q specification for handling L2CP Frames, i.e. if they should be forwarded, peered, or discarded.

IEEE 802.1Q provides a mechanism for separating the Layer2 control plane into multiple customer and provider control planes. It allows a certain layer 2 control protocol to operate only within a provider network, or to allow interaction between the customer and the provider network, or to pass transparently through a provider network with complete isolation from other customer networks.

In case of non-PB case, packet is forwarded without changing any MAC.

## L2CP Tunneling for Provider Bridging

L2CP tunneling provides support for tunneling control plane frames between CE nodes.

In the context of PB, a L2CP frame is defined as any frame containing a destination MAC address as 01:00:0C:CD:CD:D0 or 01:04:DF:CD:CD:D0 (which can be changed via CLI)

When control frames received at CEP port of a PE bridge, predefined multicast address (01-00-C2-CD-CD-D0) is replaced as destination for tunneling the packets across service provider network. If control packets are customer vlan tagged or untagged, then PE bridge will append corresponding service vlan tag to the control packet as per registration table / vlan translation table mapped to the port and send it across the service provider as a data packet.

When tunneled control packet with multicast address (01-00-C2-CD-CD-D0) received on PNP port, the multicast address is replaced with corresponding control packet multicast address and cvlan/svlan removal or update is done as per registration table / vlan translation table.

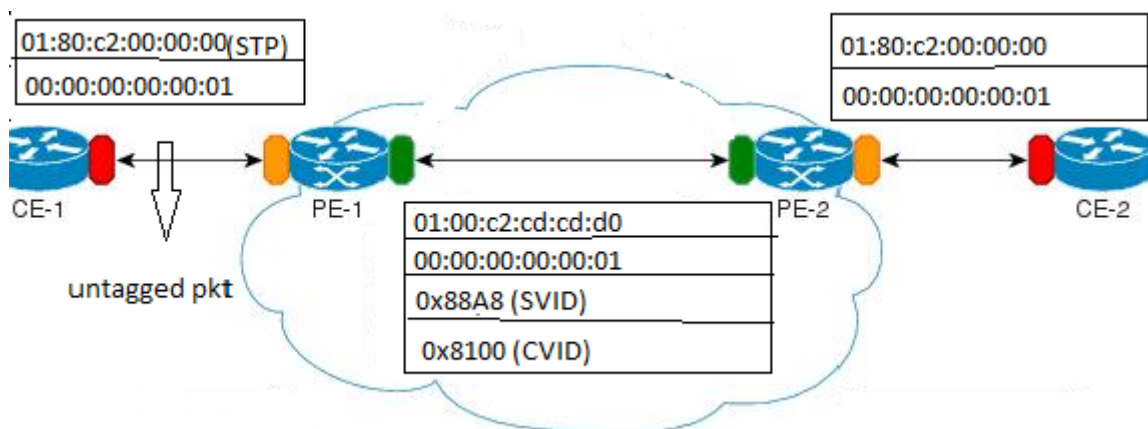

Figure 5-5: L2CP tunneling for provider bridging

## L2CP Tunneling for VPLS/VPWS/Hybrid (Bridge+VPWS)

L2CP tunneling provides support for tunneling Control plane frames across L2VPN.

## L2CP Tunneling for VXLAN

L2CP tunneling provides support for tunneling Control plane frames across VxLAN/MH.

### Topology

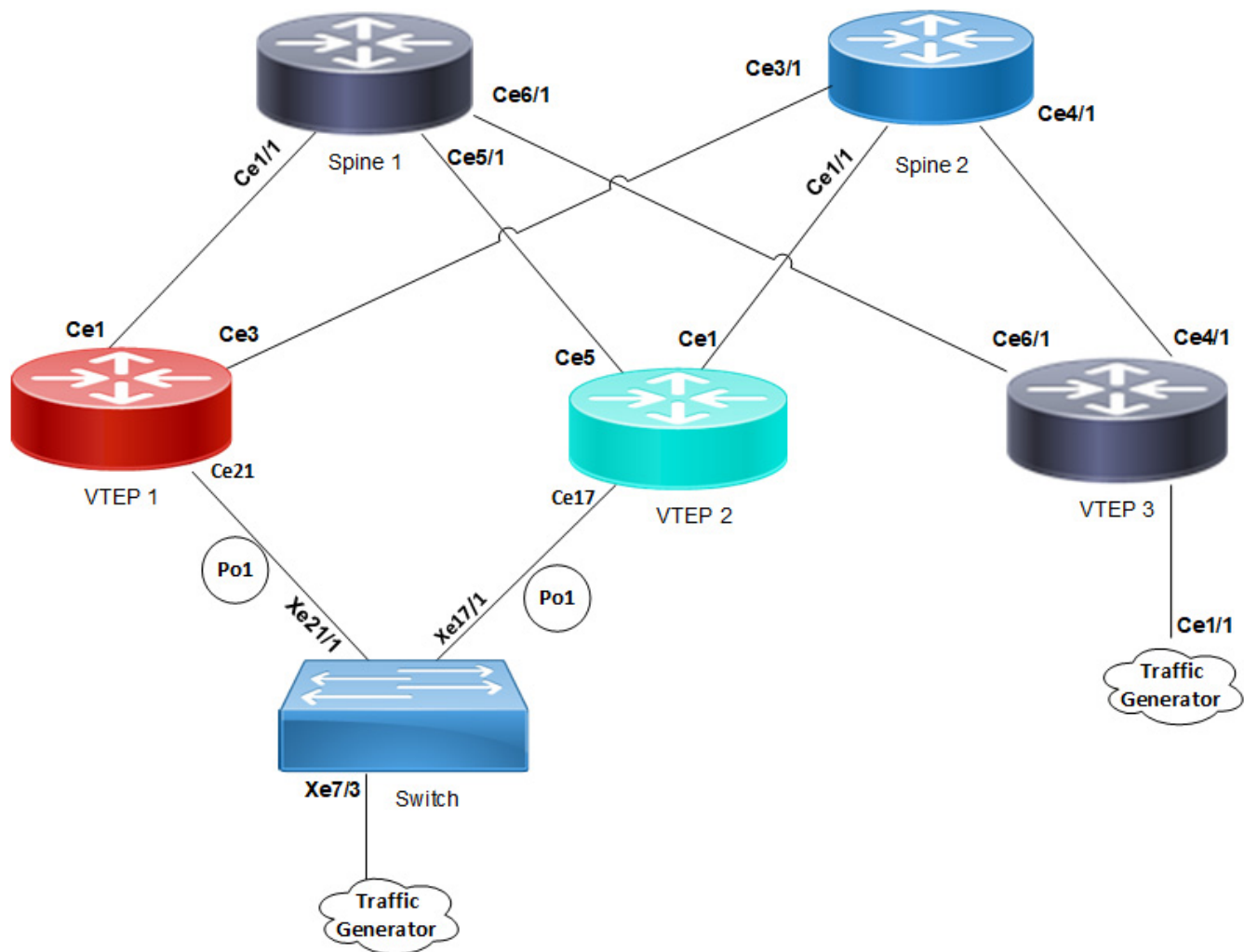

**Figure 5-6: L2CP tunneling for VXLAN**

VXLAN creates LAN segments using a MAC in IP encapsulation. The encapsulation carries the original L2 frame received from a host to the destination in another server using IP tunnels. The endpoints of the virtualized tunnel formed using VXLAN are called VTEPs (VXLAN Tunnel EndPoints).

L2CP tunneling provides support for tunneling control plane frames across VXLAN with MH/SH combination.



Any L2CP frame that is destined towards other end with a multicast destination MAC Address for L2 protocol is decided by looking at the frame and upon the configured values of the L2CP Service Attributes.

As and when Control packets with default destination MAC address for any L2 protocol is generated, it will be forwarded by VTEPs that are part of MH towards the VTEP that is part of SH and vice versa.

During this operation, the default destination MAC address for any L2 protocol is replaced with predefined multicast address as destination for tunneling the packets across SPINE nodes. When tunneled control packet with pre-defined multicast address received on ingress port on the other end of the VTEP, the multicast address is replaced with corresponding control packet multicast address.

## Default Behavior

If control packets are received at the PE router on AC port (vlan tagged/untagged), corresponding AC port properties will take care of forwarding to peer PE node. These packets are encapsulated with MPLS headers and sent across the network to the remote PE router. The egress PE router receives the packet and performs MPLS decapsulation and forwards to the CE. Except for LACP, all other control packets are tunnels across the MPLS circuit.

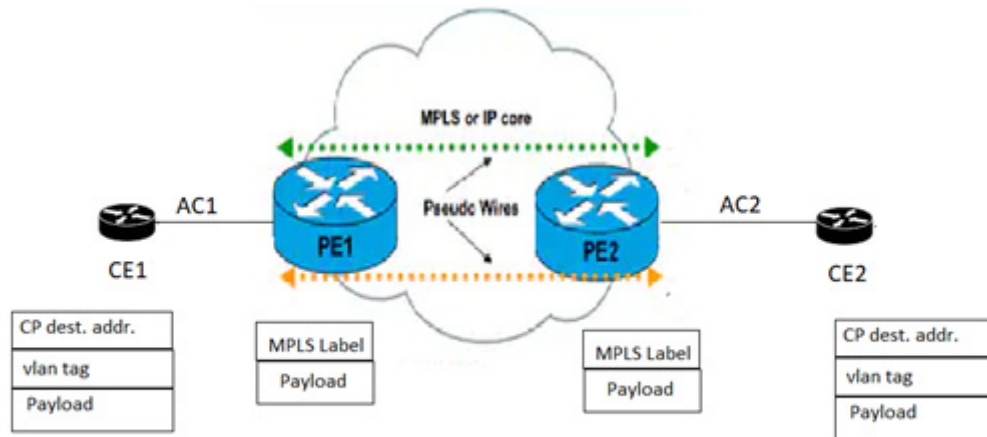

Figure 5-7: L2CP tunneling for VPLS/VPWS/Hybrid (bridge+VPWS)

## Hybrid Port

When the incoming port is configured as Hybrid (Bridge+L2VPN), L2CP switches to peering mode. You can override this behavior with the help of L2CP configurations.

## L2CP Behavior

The action taken for a given L2CP Frame at a given L2CP Decision Point depends upon the Destination Address within the frame, and upon the configured values of the L2CP Service Attributes.

The three possible actions at an L2CP Decision Points are: Discard, Peer, or Pass/Tunnel.

Discard	The L2CP frame is neither peered nor forwarded.
Peer	The L2CP frame will be processed.
Pass/Tunnel	Pass (or forwarded) means that the frame will be passed transparently in the same way as normal data frames.

## Default L2CP configuration

Default L2CP decision in Provider Bridging case:

**Table 5-1: Default L2CP decision for Provider Bridging**

Protocol Type	L2CP destination address	Ethertype/subtype	Default L2CP action
STP (Spanning Tree Protocols)	01-80-c2-00-00-00	N/A	PEER
LACP (Link Aggregation Control Protocol)	01-80-c2-00-00-02	ethertype 0x8809 and subtype 0x1 or 0x2	PEER
DOT1X (Port Authentication (802.1 X))	01-80-c2-00-00-03	N/A	PEER
LLDP (Link layer discovery protocol)	01-80-c2-00-00-0e	ethertype 0x88CC	PEER
EFM (Ethernet first mile (Link OAM))	01-80-c2-00-00-02	ethertype 0x8809 and subtype 0x3	PEER
ELMI (Ethernet Local Management Interface)	01-80-c2-00-00-07	ethertype 0x88EE	PEER

Default L2CP Decision in VPLS/VPWS/Hybrid case:

- For bridged packets in case of hybrid port:

**Table 5-2: Default L2CP decision for hybrid port**

Protocol Type	L2CP destination address	Default L2CP action
STP(Spanning Tree Protocols)	01-80-c2-00-00-00	PEER
LACP (Link Aggregation Control Protocol)	01-80-c2-00-00-02	PEER
DOT1X (Port Authentication (802.1 X))	01-80-c2-00-00-03	PEER
LLDP (Link layer discovery protocol)	01-80-c2-00-00-0e	PEER
EFM (Ethernet first mile (Link OAM))	01-80-c2-00-00-02	PEER
ELMI (Ethernet Local Management Interface)	01-80-c2-00-00-07	PEER

- For VPLS/VPWS:

**Table 5-3: Default L2CP decision for VPLS/VPWS**

Protocol Type	L2CP destination address	Default L2CP action
STP(Spanning Tree Protocols)	01-80-c2-00-00-00	TUNEEL
LACP (Link Aggregation Control Protocol)	01-80-c2-00-00-02	PEER

**Table 5-3: Default L2CP decision for VPLS/VPWS (Continued)**

Protocol Type	L2CP destination address	Default L2CP action
DOT1X (Port Authentication (802.1 X))	01-80-c2-00-00-03	TUNNEL
LLDP (Link layer discovery protocol)	01-80-c2-00-00-0e	TUNNEL
EFM (Ethernet first mile (Link OAM))	01-80-c2-00-00-02	TUNNEL
ELMI (Ethernet Local Management Interface)	01-80-c2-00-00-07	TUNNEL

## Operational Concepts and Scenarios

### Basic Configuration for L2CP for Hybrid+VPLS

Enabling tunneling at bridged interface:

```
(config-if)#show run in xel1
!
interface xel1
 speed 1g
 switchport
 bridge-group 1
 switchport mode trunk
 switchport trunk allowed vlan all
 mpls-l2-circuit vc1 service-template svc1

#config ter
#(config)interface xel1
(config-if)# l2protocol stp tunnel
(config-if)#commit
(config-if)#end
```

To display L2CP information:

```
#show l2protocol processing interface xel1
Bridge      Interface Name  Protocol      Processing Status      Hardware Status
=====      =====
-          xel1           stp           Tunnel                 Tunnel
-          xel1           lacp          None                   Peer
-          xel1           dot1x         None                   Peer
-          xel1           lldp          None                   Peer
-          xel1           efm           None                   Peer
-          xel1           elmi          None                   Peer
```

```
(config)#in xel1
(config-if)#no l2protocol stp
(config-if)#end
```

```
#show l2protocol processing interface xe11
```

Bridge	Interface Name	Protocol	Processing Status	Hardware Status
=====	=====	=====	=====	=====
-	xe11	stp	None	Peer
-	xe11	lacp	None	Peer
-	xe11	dot1x	None	Peer
-	xe11	lldp	None	Peer
-	xe11	efm	None	Peer
-	xe11	elmi	None	Peer

Note: If the configuration is not done, hardware status shows the default values while the configured will be none. On configuring L2CP on interface, configured and hardware status will be same.

---

## Basic Configuration for L2CP in VPLS

Enabling tunneling at ingress VPLS interface:

```
#show run in xe12
!
interface xe12
  speed 1g
  mpls-l2-circuit vc1 service-template svcl
!
#config ter
#(config)interface xe12
(config-if)#commit
```

To display L2CP information:

```
#show l2protocol processing interface xe12
```

Bridge	Interface Name	Protocol	Processing Status	Hardware Status
=====	=====	=====	=====	=====
-	xe12	stp	Discard	Discard
-	xe12	lacp	None	Peer
-	xe12	dot1x	None	Tunnel
-	xe12	lldp	None	Tunnel
-	xe12	efm	None	Tunnel
-	xe12	elmi	None	Tunnel

---

## Basic Configuration for L2CP on Provider Bridging

Enabling tunneling at interface:

```
(config)#bridge 1 protocol provider-rstp edge
(config)#vlan database
(config-vlan)#vlan 2-10 bridge 1 state enable
(config-vlan)#vlan 11 type service point-point bridge 1 state enable
(config-vlan)#ex
(config)#cvlan registration table map1 bridge 1
(config-cvlan-registration)#cvlan 2 svlan 11
(config-cvlan-registration)#ex
```

```
(config)#interface xe1
(config-if)#switchport
(config-if)#bridge-group 1
(config-if)#switchport mode customer-edge hybrid
(config-if)#switchport customer-edge hybrid allowed vlan all
(config-if)#switchport customer-edge vlan registration map1
(config-if)#l2protocol stp tunnel
#show running-config interface xe1
!
interface xe1
speed 1g
switchport
bridge-group 1
switchport mode customer-edge hybrid
switchport customer-edge hybrid allowed vlan all
switchport customer-edge vlan registration map1
l2protocol stp tunnel
customer-spanning-tree provider-edge svlan 11 path-cost 128
(config-if)#commit
```

### Configuring egress interfaces”

```
(config)#interface xe2
(config-if)#switchport
(config-if)#bridge-group 1
(config-if)#switchport mode provider-network
(config-if)#switchport provider-network allowed vlan all
(config-if)#commit
```

### To display L2protocol information:

```
#show l2protocol processing interface xe1
```

Bridge	Interface Name	Protocol	Processing Status	Hardware Status
=====	=====	=====	=====	=====
1	xe1	stp	Tunnel	Tunnel
1	xe1	lacp	Peer	Peer
1	xe1	dot1x	Peer	Peer
1	xe1	lldp	Peer	Peer
1	xe1	efm	Peer	Peer
1	xe1	elmi	Peer	Peer

### To display L2protocol counters:

```
#show l2protocol interface counters
Interface xe1
Tunnel          : stp          : 45
```



## CHAPTER 6 Link Aggregation Configuration

This chapter contains a complete sample Link Aggregation Group configuration.

LACP is based on the 802.3ad IEEE specification. It allows bundling of several physical interfaces to form a single logical channel providing enhanced performance and redundancy. The aggregated interface is viewed as a single link to each switch. The spanning tree views it as one interface and not as two or three interfaces. When there is a failure in one physical interface, the other interfaces stay up and there is no disruption. Traffic can be load balanced within an LACP trunk group in a controlled manner using the hashing algorithm. The maximum number of physical Ethernet links in a single logical channel depends upon the hardware support.

Note:

- Physical interfaces will inherit the properties of LAG port once it is attached to be part of LAG, irrespective of the configuration present on the physical interface.
- In case of Dynamic and Static LAG, it is possible to move member ports from one LAG to another LAG.
- Configure LAG port as a switch or router port, before adding member ports into it.

### Topology

In [Figure 6-8](#), 3 links are configured between the two switches S1 and S2. These three links are assigned the same administrative key (1) so that they aggregate to form a single channel 1. They are viewed by the STP as one interface.

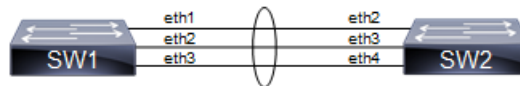

Figure 6-8: LACP Topology

### Dynamic LAG Configuration

#### SW1

SW1#configure terminal	Enter configure mode.
SW1(config)# bridge 1 protocol mstp	Configure bridge 1 as MSTP bridge
SW1(config)#vlan database	Enter vlan database mode.
SW1(config-vlan)#vlan 2-10 bridge 1 state enable	Configure a VLAN and add it to the bridge.
SW1(config-vlan)#exit	Exit vlan configuration mode.
SW1(config)#lacp system-priority 20000	Set the system priority of this switch. This priority is used for determining the system that is responsible for resolving conflicts in the choice of aggregation groups. A lower numerical value has a higher priority.
SW1(config)#interface po10	Enter into port channel interface po10.
SW1(config-if)#switchport	Configure po10 as a layer 2 port.
SW1(config-if)#bridge-group 1	Associate bridge to an interface.
SW1(config-if)#switchport mode trunk	Configure port as a trunk.

## Link Aggregation Configuration

SW1(config-if)#switchport trunk allowed vlan all	Allow all the VLANs on the po10 interface.
SW1(config-if)#exit	Exit interface mode.
SW1(config)#interface eth1	Enter interface mode.
SW1(config-if)#channel-group 10 mode active	Add this interface to channel group 10 and enable link aggregation so that it can be selected for aggregation by the local system.
SW1(config-if)#exit	Exit interface mode.
SW1(config)#interface eth2	Enter interface mode.
SW1(config-if)#channel-group 10 mode active	Add this interface to channel group 10 and enable link aggregation so that it can be selected for aggregation by the local system.
SW1(config-if)#exit	Exit interface mode.
SW1(config)#interface eth3	Enter interface mode.
SW1(config-if)#channel-group 10 mode active	Add this interface to channel group 10 and enable link aggregation so that it can be selected for aggregation by the local system.
SW1(config-if)#commit	Commit the transaction.
SW1(config-if)#exit	Exit interface mode.

## S2

SW2#configure terminal	Enter configure mode.
SW2(config)# bridge 1 protocol mstp	Configure bridge 1 as MSTP bridge
SW2(config)#vlan database	Enter vlan database mode.
SW2(config-vlan)#vlan 2-10 bridge 1 state enable	Configure a VLAN and add it to the bridge.
SW2(config-vlan)#exit	Exit vlan configuration mode.
SW1(config)#interface po10	Enter into port channel interface sa10.
SW2(config-if)#switchport	Configure po10 as a layer 2 port.
SW2(config-if)#bridge-group 1	Associate bridge to an interface.
SW2(config-if)#switchport mode trunk	Configure port as a trunk.
SW2(config-if)#switchport trunk allowed vlan all	Allow all the VLANs on the po10 interface.
SW2(config-if)#exit	Exit interface mode.
SW2(config)#interface eth2	Enter interface mode.
SW2(config-if)#channel-group 10 mode active	Add this interface to channel group 10 and enable link aggregation so that it can be selected for aggregation by the local system.
SW2(config-if)#exit	Exit interface mode.
SW2(config)#interface eth3	Enter interface mode.
SW2(config-if)#channel-group 10 mode active	Add this interface to channel group 10 and enable link aggregation so that it can be selected for aggregation by the local system.
SW2(config-if)#exit	Exit interface mode.
SW2(config)#interface eth4	Enter interface mode.



SW2(config-if)#channel-group 10 mode active	Add this interface to channel group 10 and enable link aggregation so that it can be selected for aggregation by the local system.
SW2(config-if)#commit	Commit the transaction.
SW2(config-if)#exit	Exit interface mode.

## Validation

show etherchannel detail, show etherchannel summary, show running-config interface po10, show running-config interface eth1

```
#show etherchannel detail
% Aggregator po10 7
% Aggregator Type: Layer2
% Mac address: 08:00:27:50:6a:9b
% Admin Key: 0010 - Oper Key 0010
% Actor LAG ID- 0x4e20,08-00-27-ab-ea-38,0x000a
% Receive link count: 3 - Transmit link count: 3
% Individual: 0 - Ready: 1
% Partner LAG ID- 0x4e20,08-00-27-f8-3c-30,0x000a
% Link: eth1 (3) sync: 1
% Link: eth2 (4) sync: 1
% Link: eth3 (5) sync: 1
% Collector max delay: 5
```

```
#show etherchannel summary
% Aggregator po10 7
% Aggregator Type: Layer2
% Admin Key: 0010 - Oper Key 0010
% Aggregator Type: Layer2
% Link: eth1 (3) sync: 1
% Link: eth2 (4) sync: 1
% Link: eth3 (5) sync: 1
```

```
#show running-config interface po10
!
interface po10
  switchport
  bridge-group 1
  switchport mode trunk
  switchport trunk allowed vlan all
```

```
#show running-config interface eth1
!
interface eth1
  channel-group 10 mode active
```

## Static LAG Configuration

### SW1

SW1#configure terminal	Enter configure mode.
SW1(config)# bridge 1 protocol mstp	Configure bridge 1 as MSTP bridge
SW1(config)#vlan database	Enter vlan database mode.
SW1(config-vlan)#vlan 2-10 bridge 1 state enable	Configure a VLAN and add it to the bridge.
SW1(config-vlan)#exit	Exit vlan configuration mode.
SW1(config)#interface sa10	Enter into port channel interface sa10.
SW1(config-if)#switchport	Configure sa10 as a layer 2 port.
SW1(config-if)#bridge-group 1	Associate bridge to an interface.
SW1(config-if)#switchport mode trunk	Configure port as a trunk.
SW1(config-if)#switchport trunk allowed vlan all	Allow all the VLANs on the po10 interface.
SW1(config-if)#exit	Exit interface mode.
SW1(config)#interface eth1	Enter interface mode.
SW1(config-if)#static-channel-group 10	Add this interface to channel group 10 and enable link aggregation so that it can be selected for aggregation by the local system.
SW1(config-if)#exit	Exit interface mode.
SW1(config)#interface eth2	Enter interface mode.
SW1(config-if)#static-channel-group 10	Add this interface to channel group 10 and enable link aggregation so that it can be selected for aggregation by the local system.
SW1(config-if)#exit	Exit interface mode.
SW1(config)#interface eth3	Enter interface mode.
SW1(config-if)#static-channel-group 10	Add this interface to channel group 10 and enable link aggregation so that it can be selected for aggregation by the local system.
SW1(config-if)#commit	Commit the transaction.
SW1(config-if)#exit	Exit interface mode.

### SW2

SW2#configure terminal	Enter configure mode.
SW2(config)# bridge 1 protocol mstp	Configure bridge 1 as MSTP bridge
SW2(config)#vlan database	Enter vlan database mode.
SW2(config-vlan)#vlan 2-10 bridge 1 state enable	Configure a VLAN and add it to the bridge.
SW2(config-vlan)#exit	Exit vlan configuration mode.
SW2(config)#interface sa10	Enter into port channel interface sa10.
SW2(config-if)#switchport	Configure sa10 as a layer 2 port.

SW2(config-if)#bridge-group 1	Associate bridge to an interface.
SW2(config-if)#switchport mode trunk	Configure port as a trunk.
SW2(config-if)#switchport trunk allowed vlan all	Allow all the VLANs on the po10 interface.
SW2(config-if)#exit	Exit interface mode.
SW2(config)#interface eth2	Enter interface mode.
SW2(config-if)#static-channel-group 10	Add this interface to channel group 10 and enable link aggregation so that it can be selected for aggregation by the local system.
SW2(config-if)#exit	Exit interface mode.
SW2(config)#interface eth3	Enter interface mode.
SW2(config-if)#static-channel-group 10	Add this interface to channel group 10 and enable link aggregation so that it can be selected for aggregation by the local system.
SW2(config-if)#exit	Exit interface mode.
SW2(config)#interface eth4	Enter interface mode.
SW2(config-if)#static-channel-group 10	Add this interface to channel group 10 and enable link aggregation so that it can be selected for aggregation by the local system.
SW2(config-if)#exit	Exit interface mode.
SW1(config)#commit	Commit the transaction.

## Validation

```
#show static-channel-group
% Static Aggregator: sa10
% Member status:
  eth1    up
  eth2    up
  eth3    up

#show running-config interface sa10
!
interface sa10
  switchport
  bridge-group 1
  switchport mode trunk
  switchport trunk allowed vlan all

#show running-config interface eth1
!
interface eth1
  static-channel-group 10
```

## Static LAG Minimum Link Configuration

Configure the minimum number of ports that must be linked up and bundled in the LACP port channel. We can configure the minimum links range from 2 to 32. If the number of ports aggregated to the port channel is less than the minimum number of links configured, then the port channel enters the Protocol Down because of the minimum link state.

Note: Minimum links should be configured the same on both sides for optimal performance.

### Topology

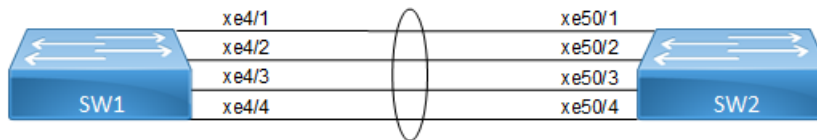

Figure 6-9: LAG Minimum Link

### SW11

#configure terminal	Enter configure mode.
(config)#interface sa10	Creating interface static-lag sa10
(config-if)#port-channel min-links 4	Configuring port channel minimum links as 4(range is 2-32)
(config-if)#commit	Commit the transaction.
(config-if)#exit	Exit the configure mode

### Validation

#### SW1

```
#show static-channel-group 10
% Static Aggregator: sa10
% Minimum-Links 4
% Member status:
    xe4/1      up
    xe4/2      up
    xe4/3      up
    xe4/4      up

#show running-config interface sa10
!
interface sa10
  switchport
  bridge-group 1
  switchport mode trunk
  switchport trunk allowed vlan all
  port-channel min-links 4
```

**SW2**

#configure terminal	Enter configure mode.
(config)#interface sa10	Creating interface port-channel sa10
(config-if)#port-channel min-links 4	Configuring port channel minimum links as 4 (range is 2-32)
(config-if)#commit	Commit the transaction.
(config-if)#exit	Exit the configure mode

**Validation****SW2**

```
#show running-config interface sa10
!
interface sa10
  switchport
  bridge-group 1
  switchport mode trunk
  switchport trunk allowed vlan all
  port-channel min-links 4
!
```

```
#show static-channel-group 10
% Static Aggregator: sa10
% Minimum-Links 4
% Member status:
    Xe50/1      up
    Xe50/2      up
    Xe50/3      up
    Xe50/4      up
```

Note:When a sa goes down due to the minimum links configured (number of minimum links is greater than the links aggregated to the sa).

SW1:

=====

```
#OcNOS#sh int brief sa10
```

```
Codes: ETH - Ethernet, LB - Loopback, AGG - Aggregate, MLAG - MLAG Aggregate
       FR - Frame Relay, TUN -Tunnel, PBB - PBB Logical Port, VP - Virtual
Port
       CVP - Channelised Virtual Port, METH - Management Ethernet, UNK-
Unknown
       ED - ErrDisabled, PD - Protocol Down, AD - Admin Down,
IA - InActive
       PD(Min L/B) - Protocol Down Min-Links/Bandwidth
       DV - DDM Violation, NA - Not Applicable
       NOM - No operational members, PVID - Port Vlan-id
       Ctl - Control Port (Br-Breakout/Bu-Bundle)
       HD - ESI Hold Timer Down
```

-----  
--

```

Port-channel  Type  PVID  Mode                Status  Reason  Speed
Interface
-----
--
sa10          AGG   1     trunk               down    PD (Min L/B)  0
OcNOS#

SW2:
=====

OcNOS#sh int brief sa10

Codes: ETH - Ethernet, LB - Loopback, AGG - Aggregate, MLAG - MLAG Aggregate
      FR - Frame Relay, TUN -Tunnel, PBB - PBB Logical Port, VP - Virtual
Port
      CVP - Channelised Virtual Port, METH - Management Ethernet, UNK-
Unknown
      ED - ErrDisabled, PD - Protocol Down, AD - Admin Down,
      IA - InActive
      PD (Min L/B) - Protocol Down Min-Links/Bandwidth
      DV - DDM Violation, NA - Not Applicable
      NOM - No operational members, PVID - Port Vlan-id
      Ctl - Control Port (Br-Breakout/Bu-Bundle)
      HD - ESI Hold Timer Down

-----
--
Port-channel  Type  PVID  Mode                Status  Reason  Speed
Interface
-----
--
sa10          AGG   1     trunk               down    PD (Min L/B)  0
OcNOS#

```

## Static-LAG Minimum Bandwidth Configuration

Configure the minimum bandwidth allowed for ports that must be linked up and bundled in the LACP port channel. We can configure the minimum bandwidth range from BANDWIDTH <1-999>k|m for 1 to 999 kilo bits or mega bits <1-1000>g for 1 to 1000 giga bits. If the Total bandwidth of ports aggregated to the port channel is less than the minimum Bandwidth value configured, then the port channel enters the Protocol Down because of the minimum Bandwidth state.

Note: Minimum Bandwidth should be configured the same on both sides for optimal performance.

## Topology

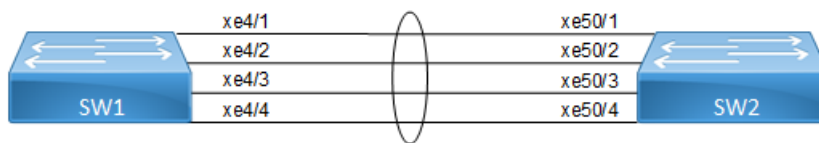

Figure 6-10: LAG Minimum Bandwidth

**SW1**

#configure terminal	Enter configure mode.
(config)#interface sa10	Creating interface static-lag sa10
(config-if)#port-channel min-bandwidth 40g	Configuring port channel minimum bandwidth as 40g (range from BANDWIDTH <1-999>k m for 1 to 999 kilo bits or mega bits <1-1000>g for 1 to 1000 giga bits.)
(config-if)#commit	Commit the transaction.
(config-if)#exit	Exit the configure mode

**Validation****SW1**

```
#show static-channel-group 10
% Static Aggregator: sa10
% Minimum- 4
% Member status:
    xe4/1      up
    xe4/2      up
    xe4/3      up
    xe4/4      up

#show running-config interface sa10
!
interface sa10
  switchport
  bridge-group 1
  switchport mode trunk
  switchport trunk allowed vlan all
  port-channel load-balance src-dst-mac
  port-channel min-links 40g
```

**SW2**

#configure terminal	Enter configure mode.
(config)#interface sa10	Creating interface port-channel sa10
(config-if)#port-channel min-bandwidth 40g	Configuring port channel minimum bandwidth as 40g (range from BANDWIDTH <1-999>k m for 1 to 999 kilo bits or mega bits <1-1000>g for 1 to 1000 giga bits.)
(config-if)#commit	Commit the transaction.
(config-if)#exit	Exit the configure mode

## Validation

### SW2

```
#show running-config interface sa10
!
interface sa10
  switchport
  bridge-group 1
  switchport mode trunk
  switchport trunk allowed vlan all
  port-channel min-bandwidth 40g
!

#show static-channel-group 10
% Static Aggregator: sa10
% Minimum-bandwidth 40g
% Member status:
    Xe50/1      up
    Xe50/2      up
    Xe50/3      up
    Xe50/4      up
```

Note: When sa goes down due to [Total Bandwidth of sa] < [Minimum Bandwidth value Configured]

SW1:

=====

```
#OcNOS #sh int brief sa10
```

Codes: ETH - Ethernet, LB - Loopback, AGG - Aggregate, MLAG - MLAG Aggregate  
FR - Frame Relay, TUN - Tunnel, PBB - PBB Logical Port, VP - Virtual

Port

CVP - Channelised Virtual Port, METH - Management Ethernet, UNK-

Unknown

ED - ErrDisabled, PD - Protocol Down, AD - Admin Down,

IA - InActive

PD(Min L/B) - Protocol Down Min-Links/Bandwidth

DV - DDM Violation, NA - Not Applicable

NOM - No operational members, PVID - Port Vlan-id

Ctl - Control Port (Br-Breakout/Bu-Bundle)

HD - ESI Hold Timer Down

```
-----
--
Port-channel Type PVID Mode           Status   Reason Speed
Interface
-----
--
sa10          AGG    1    trunk           down     PD(Min L/B)  0
OcNOS#
```

SW2:

=====



```
OcNOS#sh int brief sa10
```

```
Codes: ETH - Ethernet, LB - Loopback, AGG - Aggregate, MLAG - MLAG Aggregate
FR - Frame Relay, TUN -Tunnel, PBB - PBB Logical Port, VP - Virtual
Port
CVP - Channelised Virtual Port, METH - Management Ethernet, UNK-
Unknown
ED - ErrDisabled, PD - Protocol Down, AD - Admin Down,
IA - InActive
PD(Min L/B) - Protocol Down Min-Links/Bandwidth
DV - DDM Violation, NA - Not Applicable
NOM - No operational members, PVID - Port Vlan-id
Ctl - Control Port (Br-Breakout/Bu-Bundle)
HD - ESI Hold Timer Down
```

```
-----
--
Port-channel  Type  PVID  Mode                Status  Reason  Speed
Interface
-----
--
sa10           AGG   1     trunk               down    PD(Min L/B)  0
OcNOS#
```

!

## Dynamic-LAG Minimum Link Configuration

Configure the minimum number of ports that must be linked up and bundled in the LACP port channel. We can configure the minimum links range from 2 to 32. If the number of ports aggregated to the port channel is less than the minimum number of links configured, then the port channel enters the Protocol Down because of the minimum link state.

Note: Minimum links should be configured the same on both sides for optimal performance.

### Topology

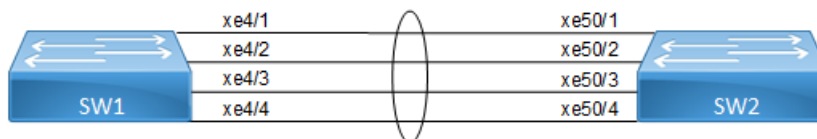

Figure 6-11: LAG Minimum Link

### SW1

#configure terminal	Enter configure mode.
(config)#interface po10	Creating interface port-channel po10
(config-if)#port-channel min-links 4	Configuring port channel minimum links as 4 (range is 2-32)
(config-if)#commit	Commit the transaction.
(config-if)#exit	Exit the configure mode

## Validation

### SW1

```
#sh running-config interface po10

interface po10
  switchport
  bridge-group 1
  switchport mode trunk
  switchport trunk allowed vlan all
  port-channel min-links 4
!

!

#show etherchannel
-----
% LACP Aggregator: po10
% Min-links : 4
% Member:
  xe4/1
  xe4/2
  xe4/3
  xe4/4
-----

#show etherchannel summary

% Aggregator po10 100010
% Aggregator Type: Layer2
% Admin Key: 0010 - Oper Key 0010
% Link: xe4/4 (10072) sync: 1
% Link: xe4/1 (10069) sync: 1
% Link: xe4/2 (10070) sync: 1
% Link: xe4/3 (10071) sync: 1
-----
```

### SW2

#configure terminal	Enter configure mode.
(config)#interface po10	Creating interface port-channel po10
(config-if)#port-channel min-links 4	Configuring port channel minimum links as 4 (range is 2-32)
(config-if)#commit	Commit the transaction.
(config-if)#exit	Exit the configure mode

## Validation

### SW2

```
#show running-config interface po10
!
```

```
interface po10
  switchport
  bridge-group 1
  switchport mode trunk
  switchport trunk allowed vlan all
  port-channel min-links 4
!
```

```
#show etherchannel
```

```
% LACP Aggregator: po10
% Min-links: 4
% Member:
  xe50/1
  xe50/2
  xe50/3
  xe50/4
```

```
#show etherchannel summary
```

```
% Aggregator po10 100010
% Aggregator Type: Layer2
% Admin Key: 0010 - Oper Key 0010
% Link: xe50/4 (10072) sync: 1
% Link: xe50/1 (10069) sync: 1
% Link: xe50/2 (10070) sync: 1
% Link: xe50/3 (10071) sync: 1
```

**Note:** When a PO goes down due to the minimum links configured (number of minimum links is greater than the links aggregated to the PO).

```
SW1:
====
```

```
#OcNOS#sh int brief po10
```

```
Codes: ETH - Ethernet, LB - Loopback, AGG - Aggregate, MLAG - MLAG Aggregate
       FR - Frame Relay, TUN - Tunnel, PBB - PBB Logical Port, VP - Virtual
Port
       CVP - Channelised Virtual Port, METH - Management Ethernet, UNK-
Unknown
       ED - ErrDisabled, PD - Protocol Down, AD - Admin Down,
       IA - InActive
       PD(Min L/B) - Protocol Down Min-Links/Bandwidth
       DV - DDM Violation, NA - Not Applicable
       NOM - No operational members, PVID - Port Vlan-id
       Ctl - Control Port (Br-Breakout/Bu-Bundle)
       HD - ESI Hold Timer Down
```

```
-----
--
Port-channel Type PVID Mode Status Reason Speed
Interface
-----
--
```

## Link Aggregation Configuration

---

```
po10          AGG  1    trunk          down    PD (Min L/B)  0
OcNOS#
```

```
OcNOS#sh etherchannel
% LACP Aggregator: po10
% Min-links: 4
% Protocol Down (Min L/B): True
% Member:
  xe4/1
  xe4/2
  xe4/3
  xe4/4
```

SW2:

====

```
OcNOS#sh etherchannel
% LACP Aggregator: po10
% Min-links: 4
% Protocol Down (Min L/B): True
% Member:
  Xe50/1
  Xe50/2
  Xe50/3
  xe50/4
```

```
OcNOS#sh int brief po10
```

```
Codes: ETH - Ethernet, LB - Loopback, AGG - Aggregate, MLAG - MLAG Aggregate
FR - Frame Relay, TUN - Tunnel, PBB - PBB Logical Port, VP - Virtual
Port
CVP - Channelised Virtual Port, METH - Management Ethernet, UNK-
Unknown
ED - ErrDisabled, PD - Protocol Down, AD - Admin Down,
IA - InActive
PD (Min L/B) - Protocol Down Min-Links/Bandwidth
DV - DDM Violation, NA - Not Applicable
NOM - No operational members, PVID - Port Vlan-id
Ctl - Control Port (Br-Breakout/Bu-Bundle)
HD - ESI Hold Timer Down
```

```
-----
--
Port-channel  Type  PVID  Mode          Status  Reason  Speed
Interface
-----
--
po10          AGG  1    trunk          down    PD (Min L/B)  0
OcNOS#
```

## Dynamic LAG Minimum Bandwidth Configuration

Configure the minimum bandwidth allowed for ports that must be linked up and bundled in the LACP port channel. We can configure the minimum bandwidth range from BANDWIDTH <1-999>k|m for 1 to 999 kilo bits or mega bits <1-1000>g for 1 to 1000 giga bits. If the Total bandwidth of ports aggregated to the port channel is less than the minimum Bandwidth value configured, then the port channel enters the Protocol Down because of the minimum Bandwidth state.

Note: Minimum Bandwidth should be configured the same on both sides for optimal performance.

### Topology

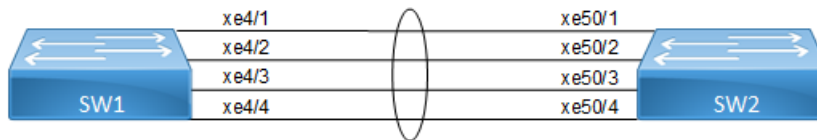

Figure 6-12: LAG Minimum Bandwidth

### SW1

#configure terminal	Enter configure mode.
(config)#interface po10	Creating interface port-channel po10
(config-if)#port-channel min-bandwidth 40g	Configuring port channel minimum bandwidth as 40g (range from BANDWIDTH <1-999>k m for 1 to 999 kilo bits or mega bits <1-1000>g for 1 to 1000 giga bits.)
(config-if)#commit	Commit the transaction.
(config-if)#exit	Exit the configure mode

### Validation

#### SW1

```
#sh running-config interface po10

interface po10
  switchport
  bridge-group 1
  switchport mode trunk
  switchport trunk allowed vlan all
  port-channel min-bandwidth 40g
  !
  !

#show etherchannel
-----
% LACP Aggregator: po10
% Min-Bandwidth : 40g
% Member:
  xe4/1
  xe4/2
```

## Link Aggregation Configuration

---

```
xe4/3
xe4/4
-----
```

```
#show etherchannel summary
```

```
% Aggregator po10 100010
% Aggregator Type: Layer2
% Admin Key: 0010 - Oper Key 0010
% Link: xe4/4 (10072) sync: 1
% Link: xe4/1 (10069) sync: 1
% Link: xe4/2 (10070) sync: 1
% Link: xe4/3 (10071) sync: 1
-----
```

## SW2

#configure terminal	Enter configure mode.
(config)#interface po10	Creating interface port-channel po10
(config-if)#port-channel min-bandwidth 40g	Configuring port channel minimum bandwidth as 40g (range from BANDWIDTH <1-999>k m for 1 to 999 kilo bits or mega bits <1-1000>g for 1 to 1000 giga bits.)
(config-if)#commit	Commit the transaction.
(config-if)#exit	Exit the configure mode

---

## Validation

### SW2

```
#show running-config interface po10
!
interface po10
 switchport
 bridge-group 1
 switchport mode trunk
 switchport trunk allowed vlan all
 port-channel min-bandwidth 40g
!
```

```
#show etherchannel
```

```
% LACP Aggregator: po10
% Min-Bandwidth : 40g
% Member:
  xe50/1
  xe50/2
  xe50/3
  xe50/4
```

```
#show etherchannel summary
```

```
% Aggregator po10 100010
```

```
% Aggregator Type: Layer2
% Admin Key: 0010 - Oper Key 0010
% Link: xe50/4 (10072) sync: 1
% Link: xe50/1 (10069) sync: 1
% Link: xe50/2 (10070) sync: 1
% Link: xe50/3 (10071) sync: 1
```

Note: When a PO goes down due to the [Total bandwidth] < [minimum bandwidth configured]

SW1:

=====

```
OcNOS#sh int brief po10
```

```
Codes: ETH - Ethernet, LB - Loopback, AGG - Aggregate, MLAG - MLAG Aggregate
Port    FR - Frame Relay, TUN -Tunnel, PBB - PBB Logical Port, VP - Virtual
Unknown CVP - Channelised Virtual Port, METH - Management Ethernet, UNK-
        ED - ErrDisabled, PD - Protocol Down, AD - Admin Down,
        IA - InActive
        PD(Min L/B) - Protocol Down Min-Links/Bandwidth
        DV - DDM Violation, NA - Not Applicable
        NOM - No operational members, PVID - Port Vlan-id
        Ctl - Control Port (Br-Breakout/Bu-Bundle)
        HD - ESI Hold Timer Down
```

```
-----
```

Port-channel	Type	PVID	Mode	Status	Reason	Speed
po10	AGG	1	trunk	down	PD(Min L/B)	0

```
-----
OcNOS#
```

```
OcNOS#sh etherchannel
% LACP Aggregator: po10
% Min-Bandwidth : 40g
% Protocol Down (Min L/B): True
% Member:
  xe4/1
  xe4/2
  xe4/3
  xe4/4
```

SW2:

=====

```
OcNOS#sh etherchannel
% LACP Aggregator: po10
% Min-Bandwidth : 40g
% Protocol Down (Min L/B): True
% Member:
  Xe50/1
  Xe50/2
```

```
Xe50/3
xe50/4
```

```
OcNOS#sh int brief po10
```

```
Codes: ETH - Ethernet, LB - Loopback, AGG - Aggregate, MLAG - MLAG Aggregate
Port    FR - Frame Relay, TUN -Tunnel, PBB - PBB Logical Port, VP - Virtual
Unknown CVP - Channelised Virtual Port, METH - Management Ethernet, UNK-
        ED - ErrDisabled, PD - Protocol Down, AD - Admin Down,
IA - InActive
        PD(Min L/B) - Protocol Down Min-Links/Bandwidth
        DV - DDM Violation, NA - Not Applicable
        NOM - No operational members, PVID - Port Vlan-id
        Ctl - Control Port (Br-Breakout/Bu-Bundle)
        HD - ESI Hold Timer Down
```

```
-----
--
Port-channel  Type  PVID  Mode                Status  Reason  Speed
Interface
-----
--
po10          AGG   1     trunk              down    PD(Min L/B)  0
OcNOS#
```

---

## LACP Minimum-Link, Minimum-Bandwidth Configurations on dynamic, static Channel-Groups with MLAG.

---

### Overview

OcNOS allows the configuration of minimum number of the LAG members per LAG group. Both these configurations are meaningful in case the LAG is used for incremental-BW mode. The minimum configuration controls the minimum number of members /bandwidth that must be operationally up / bandwidth available to declare their LAG as operationally UP.

When static/dynamic LAG interface configured with minimum links / minimum bandwidth, the following conditions are to be met:

- Ports which are admin and operational up are considered for min-link.
- The specified minimum number of links should be up.
- Min-link and min-bandwidth cannot co-exist.
- When ports are down due to min-link/min-bandwidth, in show interface brief command output, port down with the corresponding reason code for the failure due to min-link/min-bandwidth.



## Minimum Active Members/Bandwidth

The user can specify the minimum number of members that must be operationally up to declare their LAG as operationally UP. Note that this parameter applies to static/dynamic LAG.

```
port-channel min-links <2 - 32>
```

The minimum active member configuration will be allowed to be modified to be greater than the current number of active members. In such configuration, the LAG operational status will become operationally down.

The user can specify the minimum bandwidth, based on the configured value and the ports that satisfy the conditions LAG will be operationally UP. This parameter is applied for static/dynamic LAG.

```
port-channel min-bandwidth BANDWIDTH
```

BANDWIDTH <1-999>k|m for 1 to 999 kilo bits or mega bits <1-1000>g for 1 to 1000 giga bits.

When condition fails, the operational state changes to DOWN.

Note: Do not configure minimum-link, Minimum Bandwidth both on TORS and switches at the same time to avoid flaps of MLAG.

## Topology

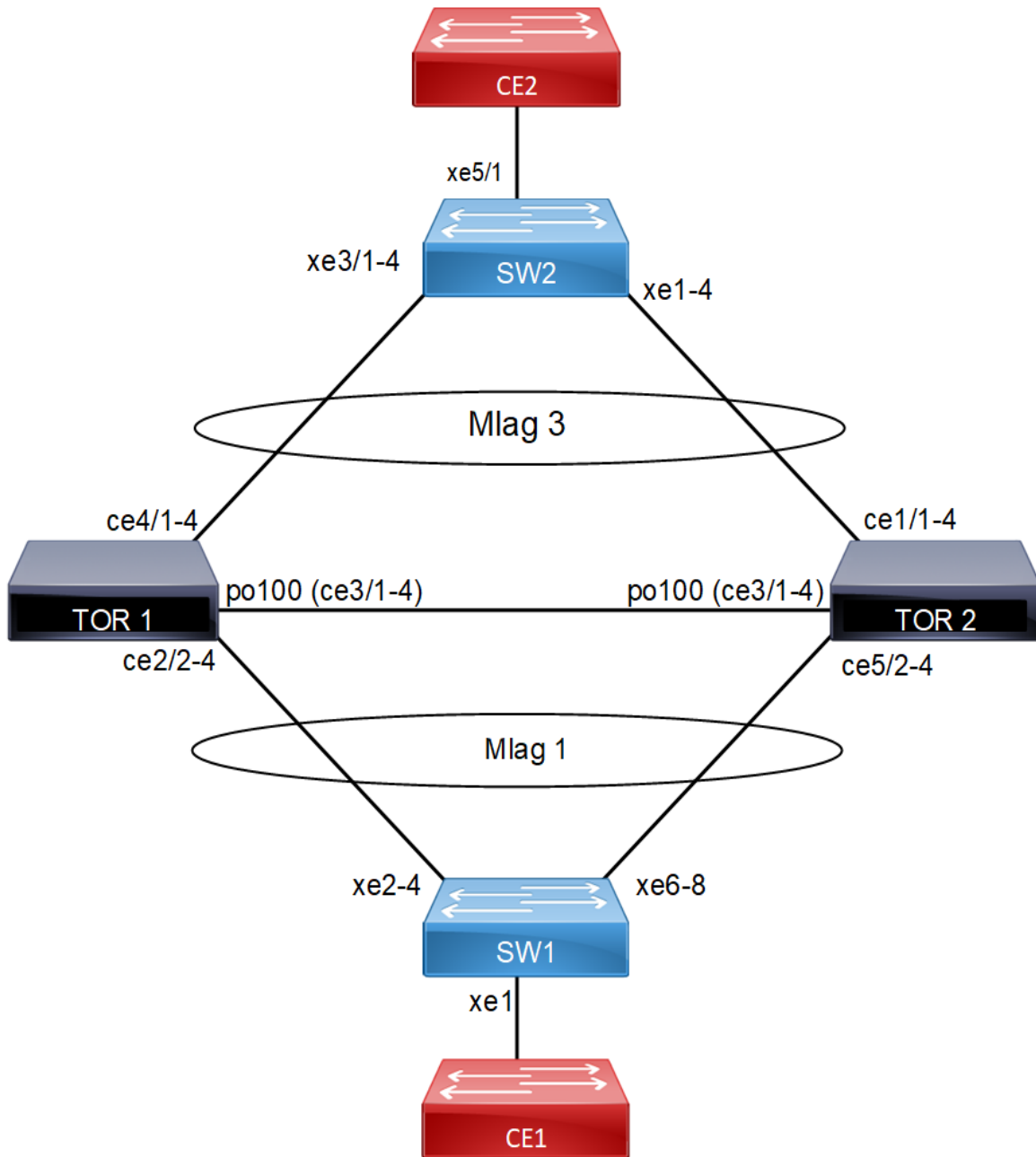

Figure 6-13: MC - LAG Topology

## Configuration

### TOR1:

#configure terminal	Enter configure mode.
(config)# bridge 1 protocol rstp vlan-bridge	Configure bridge type
(config)# vlan database	Enter vlan database mode
(config-vlan)# vlan 600,601,502 bridge 1 state enable	Configure a vlans and add it to the bridge.
(config-if)#exit	Exit vlan configuration mode.
(config)#interface mlag1	Enter Interface mode
(config-if)# switchport	Make mlag as layer2 port
(config-if)# bridge-group 1	Attach interface to bridge
(config-if)# switchport mode trunk	Configure trunk port
(config-if)# switchport trunk allowed vlan add 600,601,502	Add interface to vlans
(config-if)# spanning-tree edgeport	Configure port as edge port to avoid loops
(config-if)# spanning-tree bpdu-filter enable	Enable bpdu filter to avoid loops
(config-if)#mtu 9216	Configure mtu.
(config-if)#exit	Return to privilege mode
(config)#interface mlag3	Enter Interface mode
(config-if)# switchport	Make mlag as layer2 port
(config-if)# bridge-group 1	Attach interface to bridge
(config-if)# switchport mode trunk	Configure trunk port
(config-if)# switchport trunk allowed vlan add 600,502	Add interface to vlans
(config-if)# spanning-tree edgeport	Configure port as edge port to avoid loops
(config-if)# spanning-tree bpdu-filter enable	Enable bpdu filter to avoid loops
(config-if)#mtu 9216	Configure mtu.
(config-if)#exit	Return to privilege mode
(config)#commit	Commit the candidate configuration to the running Configuration.
(config)#interface po100	Enter Interface mode
(config-if)# switchport	Make po as layer2 port
(config-if)#exit	Exit interface mode.
(config)#interface sa1	Enter Interface mode
(config-if)# switchport	Make sa1 as layer2 port
(config-if)# port-channel load-balance src-dst-mac	Enable load balance
(config-if)#exit	Return to privilege mode

## Link Aggregation Configuration

(config)#interface sa3	Enter Interface mode
(config-if)# switchport	Make sa3 as layer2 port
(config-if)# port-channel load-balance src-dst-mac	Enable load balance
(config-if)#exit	Return to privilege mode
(config)#interface ce2/4	Enter Interface mode
(config-if)# static-channel-group 1	Add interface to sa1
(config-if)#exit	Return to privilege mode
(config)#interface ce3/1	Enter Interface mode
(config-if)# channel-group 100 mode active	Add interface to po100
(config-if)#exit	Return to privilege mode
(config)#interface ce3/2	Enter Interface mode
(config-if)# channel-group 100 mode active	Add interface to po100
(config-if)#exit	Return to privilege mode
(config)#interface ce3/3	Enter Interface mode
(config-if)# channel-group 100 mode active	Add interface to po100
(config-if)#exit	Return to privilege mode
(config)#interface ce3/4	Enter Interface mode
(config-if)# channel-group 100 mode active	Add interface to po100
(config-if)#exit	Return to privilege mode
(config)#interface ce4/1	Enter Interface mode
(config-if)# static-channel-group 3	Add interface to sa3
(config-if)#exit	Return to privilege mode
(config)#interface ce4/2	Enter Interface mode
(config-if)# static-channel-group 3	Add interface to sa3
(config-if)#exit	Return to privilege mode
(config)#interface ce4/3	Enter Interface mode
(config-if)# static-channel-group 3	Add interface to sa3
(config-if)#exit	Return to privilege mode
(config)#commit	Commit the candidate configuration to the running Configuration.
(config)#mcec domain configuration	Enter Multichasis Etherchannel domain configuration mode.
(config-mcec-domain)# domain-address 1111.2222.3333	Configure the domain address.
(config-mcec-domain)# domain-system-number 1	Configure the domain system number
(config-mcec-domain)# intra-domain-link po100	Specify the intra domain link for MLAG communication
(config-mcec-domain)#exit	Return to privilege mode
(config)#int mlag1	Enter Interface mode

(config-if)#mode active-standby	Configure mlag mode for mlag1
(config-if)#switchover type revertive 10	Configure revertive timer
(config-if)#exit	Return to privilege mode
(config)#interface sa1	Enter Interface mode
(config-if)#mlag 1	Map sa1 to mlag1
(config-if)#exit	Return to privilege mode
(config)#int mlag3	Enter Interface mode
(config-if)#mode active-standby	Configure mlag mode for mlag3
(config-if)#switchover type revertive 10	Configure revertive timer
(config-if)#exit	Return to privilege mode
(config)#interface sa3	Enter Interface mode
(config-if)#mlag 3	Map sa3 to mlag3
(config-if)#exit	Return to privilege mode
(config-if)# interface sa1	Enter sa interface mode
(config-if)#port-channel min-links 3	Configure min-link value on sa interface
(config)#interface sa3	Enter sa Interface mode
(config-if)#port-channel min-bandwidth 30g	Configure min-bandwidth value on sa/po interface
(config-if)#commit	Commit the candidate configuration to the running Configuration.
(config-if)#exit	Exit interface mode.

## TOR2

#configure terminal	Enter configure mode.
(config)#bridge 1 protocol rstp vlan-bridge	Configure bridge type
(config)# vlan database	Enter vlan database
(config-vlan)# vlan 600,601,502 bridge 1 state enable	Configure vlans
(config-vlan)#exit	Exit vlan configure mode.
(config)#interface mlag1	Enter Interface mode
(config-if)# switchport	Make mlag as layer2 port
(config-if)# bridge-group 1	Attach interface to bridge
(config-if)# switchport mode trunk	Configure trunk port
(config-if)# switchport trunk allowed vlan add 600,601,502	Add interface to vlans
(config-if)# spanning-tree edgeport	Configure port as edge port to avoid loops
(config-if)# spanning-tree bpdu-filter enable	Enable bpdu filter to avoid loops
(config-if)#mtu 9216	Configure mtu.
(config-if)#exit	Return to privilege mode

## Link Aggregation Configuration

(config)#interface mlag3	Enter Interface mode
(config-if)# switchport	Make mlag as layer2 port
(config-if)# bridge-group 1	Attach interface to bridge
(config-if)# switchport mode trunk	Configure trunk port
(config-if)# switchport trunk allowed vlan add 600,502	Add interface to vlans
(config-if)# spanning-tree edgeport	Configure port as edge port to avoid loops
(config-if)# spanning-tree bpdu-filter enable	Enable bpdu filter to avoid loops
(config-if)#mtu 9216	Configure mtu.
(config-if)#exit	Return to privilege mode
(config)#commit	Commit the candidate configuration to the running Configuration.
(config)#interface po100	Enter Interface mode
(config-if)# switchport	Make po(IDL) as layer2 port
(config-if)#exit	Return to privilege mode
(config)#interface sa1	Enter Interface mode
(config-if)# switchport	Make sa1 as layer2 port
(config-if)# port-channel load-balance src-dst-mac	Enable load balance
(config-if)#exit	Return to privilege mode
(config)#interface sa3	Enter Interface mode
(config-if)# switchport	Make sa3 as layer2 port
(config-if)# port-channel load-balance src-dst-mac	Enable load balance
(config-if)#exit	Return to privilege mode
(config)#interface ce1/1	Enter Interface mode
(config-if)# static-channel-group 3	Add interface to sa3
(config-if)#exit	Return to privilege mode
(config)#interface ce1/2	Enter Interface mode
(config-if)# static-channel-group 3	Add interface to sa3
(config-if)#exit	Return to privilege mode
(config)#interface ce1/3	Enter Interface mode
(config-if)# static-channel-group 3	Add interface to sa3
(config-if)#exit	Return to privilege mode
(config)#interface ce3/1	Enter Interface mode
(config-if)# channel-group 100 mode active	Add interface to po100
(config-if)#exit	Return to privilege mode
(config)#interface ce3/2	Enter Interface mode
(config-if)# channel-group 100 mode active	Add interface to po100

(config-if)#exit	Return to privilege mode
(config)#interface ce3/3	Enter Interface mode
(config-if)# channel-group 100 mode active	Add interface to po100
(config-if)#exit	Return to privilege mode
(config)#interface ce3/4	Enter Interface mode
(config-if)# channel-group 100 mode active	Add interface to po100
(config-if)#exit	Return to privilege mode
(config)#interface ce5/1	Enter Interface mode
(config-if)# static-channel-group 1	Add interface to sa1
(config-if)#exit	Return to privilege mode
(config)#interface ce5/2	Enter Interface mode
(config-if)# static-channel-group 1	Add interface to sa1
(config-if)#exit	Return to privilege mode
(config)#interface ce5/3	Enter Interface mode
(config-if)# static-channel-group 1	Add interface to sa1
(config-if)#exit	Return to privilege mode
(config)#commit	Commit the candidate configuration to the running Configuration.
(config)#mcec domain configuration	Enter Multichassis Etherchannel domain configuration mode.
(config-mcec-domain)# domain-address 1111.2222.3333	Configure the domain address.
(config-mcec-domain)# domain-system-number 2	Configure the domain system number
(config-mcec-domain)# intra-domain-link po100	Specify the intra domain link for MLAG communication
(config-mcec-domain)#exit	Return to privilege mode
(config)#int mlag1	Enter Interface mode
(config-if)#mode active-standby	Configure mlag mode for mlag1
(config-if)#switchover type revertive 10	Configure revertive timer
(config-if)#exit	Return to privilege mode
(config)#interface sa1	Enter Interface mode
(config-if)#mlag 1	Map sa1 to mlag1
(config-if)#exit	Return to privilege mode
(config)#int mlag3	Enter Interface mode
(config-if)#mode active-standby	Configure mlag mode for mlag3
(config-if)#switchover type revertive 10	Configure revertive timer
(config-if)#exit	Return to privilege mode
(config)#interface sa3	Enter Interface mode
(config-if)#mlag 3	Map sa3 to mlag3
(config-if)#exit	Return to privilege mode

## Link Aggregation Configuration

(config-if)#interface sa1	Enter sa interface mode
(config-if)#port-channel min-links 3	Configure min-link value on sa interface
(config)#interface sa3	Enter sa Interface mode
(config-if)#port-channel min-bandwidth 30g	Configure min-bandwidth value on sa interface.
(config-if)#commit	Commit the candidate configuration to the running Configuration.
(config-if)#exit	Exit interface mode.

## SW1

#configure terminal	Enter Configure mode.
(config)#bridge 1 protocol rstp vlan-bridge	Configure bridge type
(config)#vlan database	Create vlan database
(config-vlan)#vlan 600,601,502,101,100,300,401,402 bridge 1 state enable	Create Vlans
(config-vlan)#exit	Exit vlan configuration mode.
(config)#interface xe1	Enter Interface mode
(config-if)# switchport	Make xe1 as layer2 port
(config-if)# bridge-group 1	Associate the interface with bridge group 1.
(config-if)# switchport mode trunk	Set the switching characteristics of this interface to trunk mode.
(config-if)# switchport trunk allowed vlan all	Enable all VLAN identifiers on this interface.
(config-if)#spanning-tree edgeport	Configure port as edgeport
(config-if)#spanning-tree bpdu-filter enable	Enable spanning tree bpdu filter
(config-if)# mtu 9216	Configure mtu
(config-if)#exit	Return to privilege mode
(config)#interface sa1	Enter Interface mode
(config-if)# switchport	Make xe1 as layer2 port
(config-if)# bridge-group 1	Associate the interface with bridge group 1.
(config-if)# switchport mode trunk	Set the switching characteristics of this interface to trunk mode.
(config-if)# switchport trunk allowed vlan add 100,101,300,401,402,502	Enable all VLAN identifiers on this interface.
(config-if)# port-channel load-balance src- dst-mac	Enable load balance
(config-if)#spanning-tree edgeport	Configure port as edgeport
(config-if)#spanning-tree bpdu-filter enable	Enable spanning tree bpdu filter
(config-if)# mtu 9216	Configure mtu



<code>(config-if)#exit</code>	Return to privilege mode
<code>(config)#interface xe2</code>	Enter Interface mode
<code>(config-if)# static-channel-group 1</code>	Add interface to sa1
<code>(config-if)#exit</code>	Return to privilege mode
<code>(config)#interface xe3</code>	Enter Interface mode
<code>(config-if)# static-channel-group 1</code>	Add interface to sa1
<code>(config-if)#exit</code>	Return to privilege mode
<code>(config)#interface xe4</code>	Enter Interface mode
<code>(config-if)#static-channel-group 1</code>	Add interface to sa1
<code>(config-if)#exit</code>	Return to privilege mode
<code>(config)#interface xe6</code>	Enter Interface mode
<code>(config-if)# static-channel-group 1</code>	Add interface to sa3
<code>(config-if)#exit</code>	Return to privilege mode
<code>(config)#interface xe7</code>	Enter Interface mode
<code>(config-if)# static-channel-group 1</code>	Add interface to sa3
<code>(config-if)#exit</code>	Return to privilege mode
<code>(config)#interface xe8</code>	Enter Interface mode
<code>(config-if)# static-channel-group 1</code>	Add interface to sa3
<code>(config-if)#exit</code>	Return to privilege mode
<code>(config)#commit</code>	Commit the candidate configuration to the running Configuration.

**SW2**

<code>(config)#bridge 1 protocol rstp vlan-bridge</code>	Configure bridge type
<code>(config)#vlan database</code>	Create vlan database
<code>(config-vlan)#vlan 600,601,502,101,100, 300,401,402 bridge 1 state enable</code>	Create vlans
<code>(config-vlan)#exit</code>	Exit vlan configuration mode
<code>(config)#interface xe5/1</code>	Enter Interface mode
<code>(config-if)# switchport</code>	Make xe1 as layer2 port
<code>(config-if)# bridge-group 1</code>	Associate the interface with bridge group 1.
<code>(config-if)# switchport mode trunk</code>	Set the switching characteristics of this interface to trunk mode.
<code>(config-if)# switchport trunk allowed vlan all</code>	Enable all VLAN identifiers on this interface.
<code>(config-if)#spanning-tree edgeport</code>	Configure port as edge port
<code>(config-if)#spanning-tree bpdu-filter enable</code>	Enable spanning tree bpdu filter
<code>(config-if)# mtu 9216</code>	Configure mtu

## Link Aggregation Configuration

<code>(config-if)#exit</code>	Return to privilege mode
<code>(config)#interface sa3</code>	Enter Interface mode
<code>(config-if)# switchport</code>	Make xe1 as layer2 port
<code>(config-if)# bridge-group 1</code>	Associate the interface with bridge group 1.
<code>(config-if)# switchport mode trunk</code>	Set the switching characteristics of this interface to trunk mode.
<code>(config-if)# switchport trunk allowed vlan add 100,101,401,402,600,502</code>	Enable all VLAN identifiers on this interface.
<code>(config-if)# port-channel load-balance src-dst-mac</code>	Enable load balance
<code>(config-if)#spanning-tree edgeport</code>	Configure port as edge port
<code>(config-if)#spanning-tree bpdu-filter enable</code>	Enable spanning tree bpdu filter
<code>(config-if)# mtu 9216</code>	Configure mtu
<code>(config-if)#exit</code>	Return to privilege mode
<code>(config)#interface xe3/1</code>	Enter Interface mode
<code>(config-if)# static-channel-group 3</code>	Add interface to sa3
<code>(config-if)#exit</code>	Return to privilege mode
<code>(config)#interface xe3/2</code>	Enter Interface mode
<code>(config-if)# static-channel-group 3</code>	Add interface to sa3
<code>(config-if)#exit</code>	Return to privilege mode
<code>(config)#interface xe3/3</code>	Enter Interface mode
<code>(config-if)#static-channel-group 3</code>	Add interface to sa3
<code>(config-if)#exit</code>	Return to privilege mode
<code>(config)#interface xe1/1</code>	Enter Interface mode
<code>(config-if)#static-channel-group 3</code>	Add interface to sa3
<code>(config-if)#exit</code>	Return to privilege mode
<code>(config)#interface xe1/2</code>	Enter Interface mode
<code>(config-if)# static-channel-group 3</code>	Add interface to sa3
<code>(config-if)#exit</code>	Return to privilege mode
<code>(config)#interface xe1/3</code>	Enter Interface mode
<code>(config-if)#static-channel-group 3</code>	Add interface to sa3
<code>(config-if)#exit</code>	Exit interface mode.
<code>(config)#commit</code>	Commit the candidate configuration to the running Configuration.

This configuration is applicable for the dynamic LAG with MLAG topology except dynamic LAG interface creations, which needs to be referred from the dynamic LAG configurations given above.

---

## Validation Commands

sh int brief sa [id], sh int brief po [id], sh mlag-domain summary, sh static-channel-group <sa id>, <sh etherchannel>, sh running-config interface sa [id], <sh etherchannel summary>.

When sa or po goes down due to min-link or min-bandwidth not satisfied, below validations to be done:

### TOR

====

```
#sh int brief sa1
Codes: ETH - Ethernet, LB - Loopback, AGG - Aggregate, MLAG - MLAG Aggregate
      FR - Frame Relay, TUN -Tunnel, PBB - PBB Logical Port, VP - Virtual
Port
      CVP - Channelised Virtual Port, METH - Management Ethernet, UNK-
Unknown
      ED - ErrDisabled, PD - Protocol Down, AD - Admin Down,
      IA - InActive
      PD(Min L/B) - Protocol Down Min-Links/Bandwidth
      DV - DDM Violation, NA - Not Applicable
      NOM - No operational members, PVID - Port Vlan-id
      Ctl - Control Port (Br-Breakout/Bu-Bundle)
      HD - ESI Hold Timer Down
```

```
-----
Port-channel Type  PVID  Mode                Status  Reason  Speed
Interface
-----
--
sa1            AGG   1      trunk                down    PD(Min L/B)  0
```

```
#
#sh int brief po100
Codes: ETH - Ethernet, LB - Loopback, AGG - Aggregate, MLAG - MLAG Aggregate
      FR - Frame Relay, TUN -Tunnel, PBB - PBB Logical Port, VP - Virtual
Port
      CVP - Channelised Virtual Port, METH - Management Ethernet, UNK-
Unknown
      ED - ErrDisabled, PD - Protocol Down, AD - Admin Down,
      IA - InActive
      PD(Min L/B) - Protocol Down Min-Links/Bandwidth
      DV - DDM Violation, NA - Not Applicable
      NOM - No operational members, PVID - Port Vlan-id
      Ctl - Control Port (Br-Breakout/Bu-Bundle)
      HD - ESI Hold Timer Down
```

```
-----
--
Port-channel Type  PVID  Mode                Status  Reason  Speed
Interface
-----
--
po100         AGG   1      trunk                down    PD(Min L/B)  0
```

```
#
#sh etherchannel
```

```
% LACP Aggregator: po100
% Min-Bandwidth : 40g
% Protocol Down (Min L/B) : True
% Member:
  ce3/1
  ce3/2
  ce3/3
  ce3/4
```

```
-----
% LACP Aggregator: sa1
% Min-links : 3
% Protocol Down (Min L/B): True
% Member:
  ce2/2
  ce2/3
  ce2/4
```

```
-----
% LACP Aggregator: sa3
% Member:
  ce4/1
  ce4/2
  ce4/3
```

```
#
#sh running-config interface sa1
!
interface sa1
  switchport
  port-channel min-links 3
  mlag 1
!
```

```
#sh static-channel-group 1
Static Aggregator: sa1
Minimum-Links 3
Member Status
  ce2/2          down
  ce2/3          down
  ce2/4          down
```

```
#
#sh etherchannel summary
Aggregator po100 100100
Aggregator Type: Layer2
Admin Key: 0100 - Oper Key 0100
  Link: ce3/1 (5057) sync: 0
  Link: ce3/2 (5058) sync: 0
  Link: ce3/3 (5059) sync: 0
  Link: ce3/4 (5060) sync: 0
-----
```

---

## LACP Force-Up

In an aggregated environment, there are some parameters that are set for member ports in lag. Whenever the parameters are set and conditions are satisfied, the port channel will be in SYNC. If force-up mode is enabled for the member port, the port channel will always be in SYNC even if the parameters are not set i.e. the traffic will not be affected and the port channel will never go down.

## LACP force-up with Dynamic LAG

### Topology

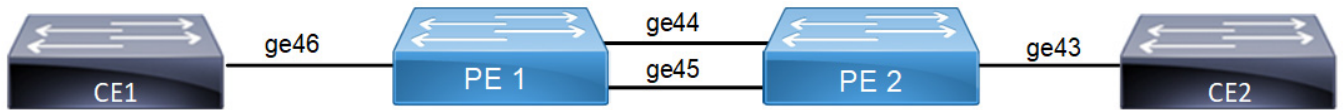

Figure 6-14: LACP force-up with Dynamic LAG

### PE1

#configure terminal	Enter configure mode.
(config)#hostname PE1	Configure host name
(config)#bridge 1 protocol rstp vlan-bridge	Create a RSTP VLAN bridge on customer side
(config)#vlan database	Enter vlan database.
(config-vlan)#vlan 2-100 bridge 1 state enable	Configure VLAN for the bridge
(config-vlan)#exit	Exit vlan configuration mode.
(config)#interface ge46	Enter interface mode
(config-if)#switchport	Make interface as Switchport
(config-if)#bridge-group 1	Associate the interface to bridge
(config-if)#switchport mode hybrid	Configure the mode as hybrid
(config-if)#switchport hybrid allowed vlan all	Configure allowed VLAN all on the interface
(config-if)#load-interval 30	Configure load period in multiple of 30 seconds
(config-if)#exit	Exit interface mode.
(config)#interface po1	Enter the interface mode
(config-if)#switchport	Make the interface as switch port
(config-if)#bridge-group 1	Associate the interface to bridge
(config-if)#switchport mode hybrid	Configure the mode as hybrid
(config-if)#switchport hybrid allowed vlan all	Configure allowed vlan all for the hybrid mode
(config-if)#load-interval 30	Configure load period in multiple of 30 seconds
(config-if)#exit	Exit interface mode.
(config)#interface ge44	Enter interface mode
(config-if)#channel-group 1 mode active	Adding interface to channel-group 1
(config-if)#exit	Exit interface mode.
(config)#interface ge45	Enter interface mode
(config-if)#channel-group 1 mode active	Adding interface to channel-group 1

## Link Aggregation Configuration

---

(config-if)#commit	Commit the candidate configuration to the running Configuration.
(config-if)#exit	Exit interface mode.

---

### PE2

#configure terminal	Enter configure mode.
(config)#hostname PE2	Configure host name
(config)#bridge 1 protocol provider-rstp edge	Create provider rstp edge bridge
(config)#vlan database	Enter vlan database mode
(config-vlan)#vlan 2-100 type customer bridge 1 state enable	Configure customer VLAN for the bridge
(config-vlan)#vlan 100 type service point-point bridge 1 state enable	Configure service VLAN for the bridge
(config)#exit	Exit vlan database mode
(config)#cvlan registration table map1 bridge 1	Creating registration table
(config-cvlan-registration)#cvlan 2-100 svlan 100	Mapping cvlan to svlan
(config-cvlan-registration)#exit	Exit cvlan registration mode.
(config)#commit	Commit the candidate configuration to the running Configuration.
(config)#interface ge43	Enter interface mode
(config-if)#switchport	Make interface as Switchport
(config-if)#bridge-group 1	Associate the interface to bridge
(config-if)#switchport mode provider-network	Configure the mode as provider-network
(config-if)# switchport provider-network allowed vlan all	Configure allowed VLAN all on the interface
(config-if)#load-interval 30	Configure load period in multiple of 30 seconds
(config-if)#exit	Exit interface mode.
(config)#interface pol	Enter the interface mode
(config-if)#switchport	Make the interface as switch port
(config-if)#bridge-group 1	Associate the interface with bridge group 1
(config-if)#switchport mode customer-edge hybrid	Set the switching characteristics of this interface to customer-edge hybrid
(config-if)#switchport customer-edge hybrid allowed vlan all	Set the switching characteristics of this interface to customer-edge hybrid and allow vlan all
(config-if)#switchport customer-edge vlan registration map1	Configuring the registration table mapping on lag interface
(config-if)#load-interval 30	Configure load period in multiple of 30 seconds
(config-if)#exit	Exit interface mode.

---

(config)#interface ge44	Enter interface mode
(config-if)#channel-group 1 mode active	Adding interface to channel-group 1
(config-if)#lacp force-up	Enable lacp force-up for the member port interface
(config-if)#exit	Exit interface mode.
(config)#interface ge45	Enter interface mode
(config-if)#channel-group 1 mode active	Adding interface to channel-group 1
(config-if)#commit	Commit the candidate configuration to the running Configuration.
(config-if)#exit	Exit interface mode.

Send L2 traffic with incremental source mac of 1000 and with VLAN 100 from CE1 and with incremental source mac of 1000 and with SVLAN 100(TPID 0x88a8), CVLAN 100 from CE2.

## Validation

### PE1

```
CE1#show mac address-table count bridge 1
MAC Entries for all vlans:
Dynamic Address Count: 2001
Static (User-defined) Unicast MAC Address Count: 0
Static (User-defined) Multicast MAC Address Count: 0
Total MAC Addresses in Use: 2001
```

```
CE1#show etherchannel summary
  Aggregator po1 100001
  Aggregator Type: Layer2
  Admin Key: 0001 - Oper Key 0001
    Link: ge44 (5043) sync: 1
    Link: ge45 (5046) sync: 1
```

```
CE1#show interface counters rate mbps
+-----+-----+-----+-----+
| Interface | Rx mbps | Rx pps | Tx mbps | Tx pps |
+-----+-----+-----+-----+
ge44       | 363.65  | 710252 | 772.76  | 1420506
ge45       | 363.63  | 710222 | 0.00    | 0
ge46       | 772.77  | 1420525| 727.31  | 1420526
po1        | 728.56  | 1422971| 774.09  | 1422966
```

```
CE2#show mac address-table count bridge 1
MAC Entries for all vlans:
Dynamic Address Count: 2001
Static (User-defined) Unicast MAC Address Count: 0
Static (User-defined) Multicast MAC Address Count: 0
Total MAC Addresses in Use: 2001
```

## Link Aggregation Configuration

```
CE2#show interface counters rate mbps
```

Interface	Rx mbps	Rx pps	Tx mbps	Tx pps
ge43	774.26	1423267	784.17	1361411
ge44	774.26	1423268	364.36	711634
ge45	0.00	0	364.36	711634
po1	774.26	1423267	728.71	1423267

```
CE2#show etherchannel summary
```

```
Aggregator po1 100001
Aggregator Type: Layer2
Admin Key: 0001 - Oper Key 0001
  Link: ge44 (5020) sync: 1
  Link: ge45 (5022) sync: 1
```

On server side (PE1) to make LAG down you can unconfigure the channel-group 1 configurations and verify force-up is getting enabled in PE2.

To simulate the force-up

PE1(config)#interface ge44	Enter interface mode.
PE1(config-if)#no channel-group	Removing channel-group configurations from interface.
PE1(config-if)#exit	Exit interface mode.
PE1(config)#interface ge45	Enter interface mode.
PE1(config-if)#no channel-group	Removing channel-group configurations from interface.
PE1(config-if)#exit	Exit interface mode.
PE1(config)#commit	Commit the candidate configuration to the running Configuration.

## PE2

```
PE2#show interface brief | include po1
po1          AGG  1      customer-edge  up      none  1g
```

```
PE2#show etherchannel summary
```

```
Aggregator po1 100001
Aggregator Type: Layer2
Admin Key: 0001 - Oper Key 0001
  Link: ge44 (5020) sync: 0 (force-up)
  Link: ge45 (5022) sync: 0
```

```
PE2#show etherchannel detail
```

```
Aggregator po1 100001
Aggregator Type: Layer2
Mac address: b8:6a:97:4d:65:d5
Admin Key: 0001 - Oper Key 0001
  Actor LAG ID- 0x8000,b8-6a-97-28-a5-c0,0x0001
  Receive link count: 0 - Transmit link count: 0
  Individual: 0 - Ready: 1
  Partner LAG ID- 0x0000,00-00-00-00-00-00,0x0000
```



```

Link: ge44 (5020) sync: 0 (force-up)
Link: ge45 (5022) sync: 0
Collector max delay: 5
    
```

To forward traffic from ge44 of PE1

PE1(config)#interface ge44	Enter interface mode.
PE1(config-if)#switchport	Make the interface as switch port.
PE1(config-if)#bridge-group 1	Associate the interface to bridge.
PE1(config-if)#switchport mode hybrid	Configure the mode as hybrid.
PE1(config-if)#switchport hybrid allowed vlan all	Configure allowed vlan all for the hybrid mode.
PE1(config-if)#load-interval 30	Configure load period in multiple of 30 seconds.
PE1(config-if)#exit	Exit interface mode.
PE1(config)#commit	Commit the candidate configuration to the running Configuration.

PE2#show interface counters rate mbps

Interface	Rx mbps	Rx pps	Tx mbps	Tx pps
ge43	774.25	1423257	784.17	1361400
ge44	774.25	1423258	728.71	1423257
ge45	0.00	0	0.00	0
po1	774.25	1423247	728.70	1423245

CE2#

PE1#show interface counters rate mbps

Interface	Rx mbps	Rx pps	Tx mbps	Tx pps
ge44	657.67	1284505	640.77	1177884
ge45	0.00	0	0.00	0
ge46	772.71	1420426	603.08	1177886

## LACP force-up with MLAG

### Topology

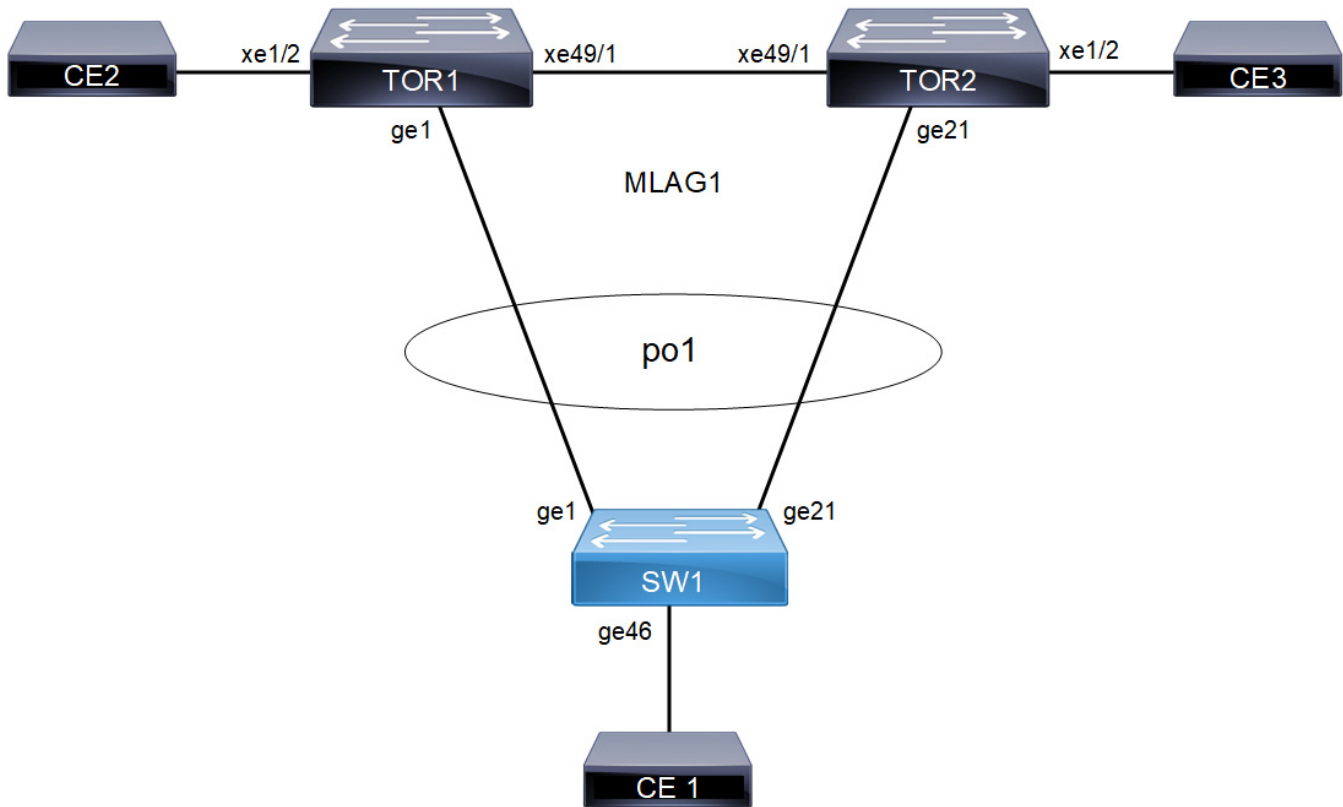

Figure 6-15: LACP force-up with MLAG

### TOR1

(config)#bridge 1 protocol provider-rstp edge	Create provider rstp bridge.
(config)#vlan database	Enter vlan database mode
(config-vlan)#vlan 2-10 type customer bridge 1 state enable	Enabling customer vlan for bridge
(config-vlan)#vlan 2-10 type service point bridge 1 state enable	Enabling service vlan for bridge
(config-vlan)#exit	Exit vlan configuration mode.
(config)#cvlan registration table map1 bridge 1	Creating registration table

(config-cvlan-registration)#cvlan 2 svlan 2	Mapping cvlan to svlan
(config-cvlan-registration)#cvlan 10 svlan 2	Mapping cvlan to svlan
(config-cvlan-registration)#exit	Exit cvlan registration mode.
(config)#commit	Commit the candidate configuration to the running configuration.
(config)#interface xe49/1	Entering interface mode
(config-if)#switchport	Configuring interface as switchport
(config-if)#exit	Exit interface mode.
(config)#interface mlag1	Entering mlag interface
(config-if)#switchport	Configuring interface as switchport
(config-if)#bridge-group 1 spanning-tree disable	Associate the interface with bridge group 1and disabling spanning-tree
(config-if)#switchport mode customer-edge hybrid	Set the switching characteristics of this interface to customer-edge hybrid
(config-if)#switchport customer-edge hybrid vlan 2	Set the switching characteristics of this interface to customer-edge hybrid and allow vlan 2
(config-if)#switchport customer-edge hybrid allowed vlan all	Set the switching characteristics of this interface to customer-edge hybrid and allow vlan all
(config-if)#switchport customer-edge vlan registration map1	Configuring the registration table mapping on mlag interface
(config-if)#exit	Exit interface mode.
(config)#interface po1	Entering dynamic lag interface
(config-if)#switchport	Configuring interface as switchport
(config-if)#mlag 1	Enabling mlag group number
(config-if)#exit	Exit interface mode.
(config)#interface ge1	Entering interface mode
(config-if)#lacp force-up	Enable lacp force-up for the member port interface
(config-if)#channel-group 1 mode active	Add this interface to channel group 1
(config-if)#exit	Exit the interface mode
(config)#mcec domain configuration	Entering MCEC mode
(config-mcec-domain)#domain-address 2222.2222.2222	Domain address for the mlag domain
(config-mcec-domain)#domain-system-number 1	Number to identify the node in a domain
(config-mcec-domain)#intra-domain-link xe49/1	Intra domain line between mlag domain
(config-mcec-domain)#exit	Exit mcec domain mode.
(config)#commit	Commit the candidate configuration to the running configuration.

**TOR2**

(config)#bridge 1 protocol provider-rstp edge	Create provider rstp bridge.
(config)#vlan database	Enter vlan database mode
(config-vlan)#vlan 2-10 type customer bridge 1 state enable	Enabling customer vlan for bridge
(config-vlan)#vlan 2-10 type service point-point bridge 1 state enable	Enabling service vlan for bridge
(config-vlan)#exit	Exit vlan database mode.
(config)#cvlan registration table map1 bridge 1	Creating registration table
(config-cvlan-registration)#cvlan 2 svlan 2	Mapping cvlan to svlan
(config-cvlan-registration)#cvlan 10 svlan 2	Mapping cvlan to svlan
(config-cvlan-registration)#exit	Exit cvlan registration mode.
(config)#commit	Commit the candidate configuration to the running configuration.
(config)#interface xe49/1	Entering interface mode
(config-if)#switchport	Configuring interface as switchport
(config-if)#exit	Exit interface mode.
(config)#interface mlag1	Entering mlag interface
(config-if)#switchport	Configuring interface as switchport
(config-if)#bridge-group 1 spanning-tree disable	Associate the interface with bridge group 1 and disabling spanning-tree
(config-if)#switchport mode customer-edge hybrid	Set the switching characteristics of this interface to customer-edge hybrid
(config-if)#switchport customer-edge hybrid vlan 2	Set the switching characteristics of this interface to customer-edge hybrid and allow vlan 2
(config-if)#switchport customer-edge hybrid allowed vlan all	Set the switching characteristics of this interface to customer-edge hybrid and allow vlan all
(config-if)#switchport customer-edge vlan registration map1	Configuring the registration table mapping on mlag interface
(config-if)#exit	Exit interface mode.
(config)#interface pol	Entering dynamic lag interface
(config-if)#switchport	Configuring interface as switchport
(config-if)#mlag 1	Enabling mlag group number
(config-if)#exit	Exit interface mode.
(config)#interface ge21	Entering interface mode
(config-if)#lacp force-up	Enable lacp force-up for the member port interface

(config-if)#channel-group 1 mode active	Add this interface to channel group 1
(config-if)#exit	Exit the interface mode
(config)#mcec domain configuration	Entering MCEC mode
(config-mcec-domain)#domain-address 2222.2222.2222	Domain address for the mlag domain
(config-mcec-domain)#domain-system-number 2	Number to identify the node in a domain
(config-mcec-domain)#intra-domain-link xe49/1	Intra domain line between mlag domain
(config-mcec-domain)#exit	Exit mcec domain mode.
(config)#commit	Commit the candidate configuration to the running configuration.

**SW1**

(config)#config t	Enter configure terminal.
(config)#bridge 1 protocol rstp vlan-bridge	Configuring the rstp vlan bridge
(config)#vlan database	Enter vlan database mode.
(config-vlan)#vlan 2-10 bridge 1 state enable	Configure customer vlan.
(config-vlan)#exit	Exit vlan configuration mode.
(config)#interface po1	Entering interface mode
(config-if)#switchport	Configuring interface as switchport
(config-if)#bridge-group 1 spanning-tree disable	Associate the interface with bridge group 1 and disabling spanning-tree
(config-if)#switchport mode access	Configure switchport mode as access
(config-if)#switchport access vlan 2,10	Configure access vlan 2,10
(config-if)#exit	Exit interface mode.
(config)#interface ge1	Entering interface mode
(config-if)#channel-group 1 mode active	Add this interface to channel group 1 .
(config-if)#exit	Exit interface mode.
(config)#interface ge21	Entering interface mode
(config-if)#channel-group 1 mode active	Add this interface to channel group 1.
(config-if)#exit	Exit interface mode.
(config-if)#interface ge46	Entering interface mode
(config-if)#switchport	Configuring interface as switchport
(config-if)#bridge-group 1 spanning-tree disable	Associate the interface with bridge group 1and disabling spanning-tree
(config-if)#switchport mode hybrid	Set the switching characteristics of this interface to hybrid
(config-if)#switchport hybrid allowed vlan all	Set the switching characteristics of this interface to hybrid and allow vlan all

## Link Aggregation Configuration

---

(config-if)#exit	Exit interface mode.
(config)#commit	Commit the candidate configuration to the running configuration.

---

## Validation

TOR1#show etherchannel summary

```
Aggregator po1 100001
Aggregator Type: Layer2
Admin Key: 32769 - Oper Key 16385
  Link: ge1 (5026) sync: 1
```

TOR2#show etherchannel summary

```
Aggregator po1 100001
Aggregator Type: Layer2
Admin Key: 16385 - Oper Key 16385
  Link: ge21 (5046) sync: 1
```

SW1#show etherchannel summary

```
Aggregator po2 100002
Aggregator Type: Layer2
Admin Key: 0002 - Oper Key 0002
  Link: ge2 (5001) sync: 1
  Link: ge22 (5021) sync: 1
```

TOR1#show mlag domain summary

-----  
Domain Configuration  
-----

```
Domain System Number      : 2
Domain Address             : 1111.2222.3333
Domain Priority            : 32768
Intra Domain Interface    : po99
Domain Adjacency          : UP
-----
```

MLAG Configuration  
-----

MLAG-1

```
Mapped Aggregator        : po1
Physical properties Digest : 1 ef 71 4b 7f 37 5b 6a a5 8c e1 2f 95 9a fe cf
Total Bandwidth          : 2g
Mlag Sync                : IN_SYNC
Mode                     : Active-Active
Current Mlag state       : Active
```

---

```
TOR2#show mlag domain summary
```

```
-----  
Domain Configuration  
-----
```

```
Domain System Number      : 1  
Domain Address            : 1111.2222.3333  
Domain Priority           : 32768  
Intra Domain Interface   : po99  
Domain Adjacency         : UP  
-----
```

```
MLAG Configuration  
-----
```

```
MLAG-1
```

```
Mapped Aggregator        : po1  
Physical properties Digest : 1 ef 71 4b 7f 37 5b 6a a5 8c e1 2f 95 9a fe cf  
Total Bandwidth          : 2g  
Mode                     : Active-Active  
Current Mlag state       : Activ
```

```
TOR1#show mac address-table count bridge 1 interface mlag1
```

```
MAC Entries for all vlans:
```

```
Dynamic Address Count: 1001
```

```
Static (User-defined) Unicast MAC Address Count: 0
```

```
Static (User-defined) Multicast MAC Address Count: 0
```

```
Total MAC Addresses in Use: 1001
```

```
TOR1#show mac address-table 1 count bridge 1 interface mlag1
```

```
MAC Entries for all vlans:
```

```
Total MAC Addresses in Use: 500
```

```
TOR1#show mac address-table r count bridge 1 interface mlag1
```

```
MAC Entries for all vlans:
```

```
Total MAC Addresses in Use: 501
```

```
TOR2#show mac address-table count bridge 1 interface mlag1
```

```
MAC Entries for all vlans:
```

```
Dynamic Address Count: 1001
```

```
Static (User-defined) Unicast MAC Address Count: 0
```

```
Static (User-defined) Multicast MAC Address Count: 0
```

```
Total MAC Addresses in Use: 1001
```

```
TOR2#show mac address-table 1 count bridge 1 interface mlag1
```

```
MAC Entries for all vlans:
```

```
Total MAC Addresses in Use: 501
```

```
TOR2#show mac address-table r count bridge 1 interface mlag1
```

```
MAC Entries for all vlans:
```

## Link Aggregation Configuration

---

Total MAC Addresses in Use: 500

Note: For MLAG case, admin should configure 'force-up' port either on master node or slave node only.

Example: In a static trunk environment, Preboot eXecution Environment (PXE) images are too small for most operating systems to leverage LACP during the boot process. As a result, during a PXE build process, traffic sent by the server is dropped, and the build process can fail.

To correct this situation, a port on an ICX 7750 device connected to a server that is configured as an MCT client can be set to a "force-up" state so that even if the LACPDU is not received from the server, the connected port is up and forwards packets.

To simulate this scenario we can remove channel-group configurations from the server side switch SW1 and check LACP force-up is getting enabled on TOR1:

SW1(config)#interface ge1	Enter interface mode.
SW1(config-if)#no channel-group	Removing channel-group configurations from interface.
SW1(config-if)#exit	Exit interface mode.
SW1(config)#interface ge21	Enter interface mode.
SW1(config-if)#no channel-group	Removing channel-group configurations from interface.
SW1(config-if)#exit	Exit interface mode.
SW1(config)#commit	Commit the candidate configuration to the running Configuration.

```
TOR1#show etherchannel summary
  Aggregator pol 100001
  Aggregator Type: Layer2
  Admin Key: 32769 - Oper Key 16385
  Link: ge1 (5026) sync: 0 (force-up)
```

```
TOR2#show etherchannel summary
  Aggregator pol 100001
  Aggregator Type: Layer2
  Admin Key: 16385 - Oper Key 16385
  Link: ge21 (5046) sync: 0
```

```
TOR1#show mlag domain summary
-----
Domain Configuration
-----
Domain System Number      : 2
Domain Address            : 1111.2222.3333
Domain Priority           : 32768
Intra Domain Interface    : po99
Domain Adjacency          : UP
-----
MLAG Configuration
-----
MLAG-1
```



```

Mapped Aggregator          : po1
Physical properties Digest : 1 ef 71 4b 7f 37 5b 6a a5 8c e1 2f 95 9a fe cf
Total Bandwidth           : 1g
Mlag Sync                 : IN_SYNC
Mode                      : Active-Active
Current Mlag state        : Active
    
```

TOR2#show mlag domain summary

-----  
Domain Configuration  
-----

```

Domain System Number      : 1
Domain Address            : 1111.2222.3333
Domain Priority           : 32768
Intra Domain Interface   : po99
Domain Adjacency         : UP
    
```

-----  
MLAG Configuration  
-----

MLAG-1

```

Mapped Aggregator          : po1
Physical properties Digest : 1 ef 71 4b 7f 37 5b 6a a5 8c e1 2f 95 9a fe cf
Total Bandwidth           : 1g
Mlag Sync                 : IN_SYNC
Mode                      : Active-Active
Current Mlag state        : Active
    
```

To forward traffic from ge1 of SW2:

SW1(config)#interface ge1	Enter interface mode.
SW1(config-if)#switchport	Make the interface as switch port.
SW1(config-if)#bridge-group 1 spanning-tree disable	Associate the interface to bridge.
SW1(config-if)#switchport mode access	Configure the mode as access.
SW1(config-if)#switchport access vlan 4001	Configure allowed vlan 4001 for the access mode.
SW1(config-if)#load-interval 30	Configure load period in multiple of 30 seconds.
SW1(config-if)#commit	Commit the candidate configuration to the running configuration.
SW1(config-if)#exit	Exit interface mode.

```

TOR1#show mac address-table count bridge 1 interface mlag1
MAC Entries for all vlans:
Dynamic Address Count: 999
Static (User-defined) Unicast MAC Address Count: 0
Static (User-defined) Multicast MAC Address Count: 0
Total MAC Addresses in Use: 999
    
```

## Link Aggregation Configuration

---

```
TOR1#show mac address-table 1 count bridge 1 interface mlag1
MAC Entries for all vlans:
Total MAC Addresses in Use: 999
TOR1#show mac address-table r count bridge 1 interface mlag1
MAC Entries for all vlans:
Total MAC Addresses in Use: 0
```

```
TOR2#show mac address-table count bridge 1 interface mlag1
MAC Entries for all vlans:
Dynamic Address Count: 0
Static (User-defined) Unicast MAC Address Count: 0
Static (User-defined) Multicast MAC Address Count: 0
Total MAC Addresses in Use: 0
```

```
TOR2#show mac address-table 1 count bridge 1 interface mlag1
MAC Entries for all vlans:
Total MAC Addresses in Use: 0
TOR2#show mac address-table r count bridge 1 interface mlag1
MAC Entries for all vlans:
Total MAC Addresses in Use: 0
```

```
TOR1#show etherchannel summary
  Aggregator po1 100001
  Aggregator Type: Layer2
  Admin Key: 32769 - Oper Key 16385
    Link: ge1 (5026) sync: 0 (force-up)
```

```
TOR1#show etherchannel detail
  Aggregator po1 100001
  Aggregator Type: Layer2
  Mac address: 14:02:ec:1c:31:5b
  Admin Key: 32769 - Oper Key 16385
  Actor LAG ID- 0x8000,11-11-22-22-33-33,0x4001
  Receive link count: 0 - Transmit link count: 0
  Individual: 0 - Ready: 1
  Partner LAG ID- 0x0000,00-00-00-00-00-00,0x0000
    Link: ge1 (5026) sync: 0 (force-up)
  Collector max delay: 5
```

```
SW1#show interface counters rate mbps
```

Interface	Rx mbps	Rx pps	Tx mbps	Tx pps
ge1	0.00	0	726.53	1418994
ge46	772.68	1420362	0.00	0

---

TOR1#show interface counters rate mbps

Interface	Rx mbps	Rx pps	Tx mbps	Tx pps
ge1	729.42	1424656	0.00	0
mlag1	729.42	1424655	0.00	0
po1	729.43	1424658	0.00	0



## CHAPTER 7 Link Layer Discovery Protocol Configuration

This chapter contains a complete sample Link Layer Discovery Protocol (LLDP) configuration.

LLDP is a neighbor discovery protocol that defines a method for network access devices using Ethernet connectivity to advertise themselves to other devices on the same physical LAN, and then to store information about the network. It allows a device to learn higher-layer management reachability and connection endpoint information from adjacent devices. Using LLDP, a network device is able to advertise its identity, its capabilities and its media-specific configuration, as well as learn the same information from other connected devices.

Note: The `lldp-agent` command is not supported for SVLAN, VLAN, and loop-back interfaces.

### Topology

Figure 7-16 displays a sample LLDP topology.

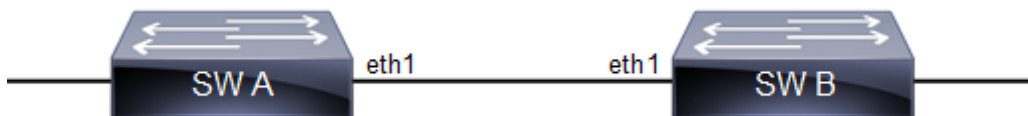

Figure 7-16: LLDP Topology

### LLDPv2 (Interface Mode TLV)

#### Default Agent

All configuration commands in the table below should be followed for each machines.

<code>#configure terminal</code>	Enter configure mode.
<code>(config)#bridge 1 protocol ieee vlan-bridge</code>	Configure an IEEE VLAN-aware bridge.
<code>(config)#vlan database</code>	Enter VLAN configure mode.
<code>(config-vlan)#vlan 2 bridge 1 state enable</code>	Configure a VLAN and add it to the bridge.
<code>(config-vlan)#exit</code>	Exit the VLAN configuration mode.
<code>(config)#interface eth1</code>	Enter interface mode.
<code>(config-if)#switchport</code>	Set switching characteristics on the port.
<code>(config-if)#bridge-group 1</code>	Associate the interface to the bridge.
<code>(config-if)#lldp-agent</code>	Enter into the default agent
<code>(if-lldp-agent)#set lldp enable txrx</code>	Enable an LLDP agent on the port.
<code>(if-lldp-agent)#set lldp chassis-id-tlv ip-address</code>	Configure the subtype for chassis-id TLV
<code>(if-lldp-agent)#set lldp port-id-tlv mac-address</code>	Configure the subtype for port-id TLV

## Link Layer Discovery Protocol Configuration

<pre>(if-lldp-agent)# lldp tlv basic-mgmt port-description select</pre>	Enable the port-description TLV to be transmitted on the port
<pre>(if-lldp-agent)# lldp tlv basic-mgmt system-name select</pre>	Enable the system-name TLV to be transmitted on the port
<pre>(if-lldp-agent)# lldp tlv basic-mgmt system-capabilities select</pre>	Enable the system-capabilities TLV to be transmitted on the port
<pre>(if-lldp-agent)# lldp tlv basic-mgmt system-description select</pre>	Enable the system-description TLV to be transmitted on the port
<pre>(if-lldp-agent)# lldp tlv basic-mgmt management-address select</pre>	Enable the management-address TLV to be transmitted on the port
<pre>(if-lldp-agent)# lldp tlv ieee-8021-org-specific port-vlanid select</pre>	Enable the VLAN-id TLV to be transmitted on the port
<pre>(if-lldp-agent)# lldp tlv ieee-8021-org-specific vlan-name select</pre>	Enable the VLAN-NAME TLV to be transmitted on the port
<pre>(if-lldp-agent)# lldp tlv ieee-8021-org-specific port-ptcl-vlanid select</pre>	Enable the Port and Protocol VLAN id TLV to be transmitted on the port
<pre>(if-lldp-agent)# lldp tlv ieee-8021-org-specific ptcl-identity select</pre>	Enable the Protocol Identity TLV to be transmitted on the port
<pre>(if-lldp-agent)# lldp tlv ieee-8021-org-specific vid-digest select</pre>	Enable the VID Usage Digest TLV to be transmitted on the port
<pre>(if-lldp-agent)# lldp tlv ieee-8021-org-specific mgmt-vid select</pre>	Enable the Management VID TLV to be transmitted on the port
<pre>(if-lldp-agent)# lldp tlv ieee-8021-org-specific link-agg select</pre>	Enable the Link Aggregation TLV to be transmitted on the port
<pre>(if-lldp-agent)# lldp tlv ieee-8023-org-specific mac-phy select</pre>	Enable the MAC/PHY Configuration/Status TLV to be transmitted on the port
<pre>(if-lldp-agent)# lldp tlv ieee-8023-org-specific max-mtu-size select</pre>	Enable the Maximum Frame Size TLV to be transmitted on the port
<pre>(if-lldp-agent)#set lldp timer msg-fast-tx 5</pre>	Defines the time interval during fast transmission periods
<pre>(if-lldp-agent)#set lldp tx-fast-init 6</pre>	Defines the number of LLDPDUs that are transmitted during a fast transmission period
<pre>(if-lldp-agent)#exit</pre>	Exit the lldp agent mode
<pre>(config-if)#commit</pre>	Commit the transaction.
<pre>(config-if)#exit</pre>	Exit interface mode.

## Validation

1. Verify the LLDP configurations in the local machine

```
#show running-config lldp
!
interface eth0
  lldp-agent
!
interface eth1
  lldp-agent
```

```

set lldp enable txrx
set lldp chassis-id-tlv ip-address
lldp tlv-select basic-mgmt port-description
lldp tlv-select basic-mgmt system-name
lldp tlv-select basic-mgmt system-capabilities
lldp tlv-select basic-mgmt system-description
lldp tlv-select basic-mgmt management-address
lldp tlv-select ieee-8021-org-specific port-vlanid
lldp tlv-select ieee-8021-org-specific vlan-name
lldp tlv-select ieee-8021-org-specific port-ptcl-vlanid
lldp tlv-select ieee-8021-org-specific ptcl-identity
lldp tlv-select ieee-8021-org-specific vid-digest
lldp tlv-select ieee-8021-org-specific mgmt-vid
lldp tlv-select ieee-8021-org-specific link-agg
lldp tlv-select ieee-8023-org-specific mac-phy
lldp tlv-select ieee-8023-org-specific max-mtu-size
set lldp timer msg-fast-tx 5
set lldp tx-fast-init 6
!
interface eth2
  lldp-agent
!
interface eth3
  lldp-agent

```

## 2. Verify the LLDP port statistics

```
#show lldp interface eth1 nearest-bridge
```

```

Agent Mode                : Nearest bridge
Enable (tx/rx)            : Y/Y
Message fast transmit time : 5
Message transmit interval : 30
Message fast transmit interval : 6
Maximum transmit credit   : 5
Reinitialisation delay    : 2
MED Enabled                : N
Device Type               : Not Defined
Traffic statistics        :
Total frames transmitted   : 0
Total entries aged        : 0
Total frames received      : 5
Total error frames received : 0
Total frames discarded     : 0
Total discarded TLVs      : 0
Total unrecognised TLVs   : 0

```

---

## Customer Bridge

All configuration commands in the table below should be followed for each machine.

#configure terminal	Enter configure mode.
(config)#bridge 1 protocol ieee vlan-bridge	Configure an IEEE VLAN-aware bridge.

---

## Link Layer Discovery Protocol Configuration

(config)#vlan database	Enter VLAN configure mode.
(config-vlan)#vlan 2 bridge 1 state enable	Configure a VLAN and add it to the bridge.
(config-vlan)#exit	Exit the VLAN configuration mode.
(config)#interface eth1	Enter interface mode.
(config-if)#switchport	Set switching characteristics on the port.
(config-if)#bridge-group 1	Associate the interface to the bridge.
(config-if)#lldp-agent customer-bridge	Enter into the Customer Bridge agent
(if-lldp-agent)#set lldp enable txrx	Enable an LLDP agent on the port.
(if-lldp-agent)#set lldp chassis-id-tlv ip-address	Configure the subtype for chassis-id TLV
(if-lldp-agent)#set lldp port-id-tlv mac-address	Configure the subtype for port-id TLV
(if-lldp-agent)# lldp tlv basic-mgmt port-description select	Enable the port-description TLV to be transmitted on the port.
(if-lldp-agent)# lldp tlv basic-mgmt system-name select	Enable the system-name TLV to be transmitted on the port.
(if-lldp-agent)# lldp tlv basic-mgmt system-capabilities select	Enable the system-capabilities TLV to be transmitted on the port.
(if-lldp-agent)# lldp tlv basic-mgmt system-description select	Enable the system-description TLV to be transmitted on the port.
(if-lldp-agent)# lldp tlv basic-mgmt management-address select	Enable the management-address TLV to be transmitted on the port.
(if-lldp-agent)# lldp tlv ieee-8021-org-specific port-vlanid select	Enable the VLAN-id TLV to be transmitted on the port.
(if-lldp-agent)# lldp tlv ieee-8021-org-specific vlan-name select	Enable the VLAN-NAME TLV to be transmitted on the port.
(if-lldp-agent)# lldp tlv ieee-8021-org-specific port-ptcl-vlanid select	Enable the Port and Protocol VLAN id TLV to be transmitted on the port.
(if-lldp-agent)# lldp tlv ieee-8021-org-specific ptcl-identity select	Enable the Protocol Identity TLV to be transmitted on the port.
(if-lldp-agent)# lldp tlv ieee-8021-org-specific vid-digest select	Enable the VID Usage Digest TLV to be transmitted on the port
(if-lldp-agent)# lldp tlv ieee-8021-org-specific mgmt-vid select	Enable the Management VID TLV to be transmitted on the port.
(if-lldp-agent)# lldp tlv ieee-8021-org-specific link-agg select	Enable the Link Aggregation TLV to be transmitted on the port.
(if-lldp-agent)# lldp tlv ieee-8023-org-specific mac-phy select	Enable the MAC/PHY Configuration/Status TLV to be transmitted on the port
(if-lldp-agent)# lldp tlv ieee-8023-org-specific max-mtu-size select	Enable the Maximum Frame Size TLV to be transmitted on the port.
(if-lldp-agent)#set lldp timer msg-fast-tx 5	Defines the time interval during fast transmission periods.
(if-lldp-agent)#set lldp tx-fast-init 6	Defines the number of LLD PDUs that are transmitted during a fast transmission period.



(if-lldp-agent)#exit	Exit the lldp agent mode
(config-if)#commit	Commit the transaction.
(config-if)#exit	Exit interface mode.

## Validation

### 1. Verify the LLDP configurations in the local machine

```
#show running-config lldp
!
interface eth1
  lldp-agent customer-bridge
  set lldp enable txrx
  set lldp chassis-id-tlv ip-address
  set lldp port-id-tlv mac-address
  lldp tlv basic-mgmt port-description select
  lldp tlv basic-mgmt system-name select
  lldp tlv basic-mgmt system-description select
  lldp tlv basic-mgmt system-capabilities select
  lldp tlv basic-mgmt management-address select
  lldp tlv ieee-8021-org-specific port-vlanid select
  lldp tlv ieee-8021-org-specific port-ptcl-vlanid select
  lldp tlv ieee-8021-org-specific vlan-name select
  lldp tlv ieee-8021-org-specific ptcl-identity select
  lldp tlv ieee-8021-org-specific vid-digest select
  lldp tlv ieee-8021-org-specific mgmt-vid select
  lldp tlv ieee-8021-org-specific link-agg select
  lldp tlv ieee-8023-org-specific mac-phy select
  lldp tlv ieee-8023-org-specific max-mtu-size select
  set lldp timer msg-fast-tx 5
  set lldp tx-fast-init 6
!
```

### 2. Verify the LLDP port statistics

```
#show lldp interface eth1 customer-bridge

Agent Mode                : Customer-bridge
Enable (tx/rx)            : Y/Y
Message fast transmit time : 5
Message transmit interval : 30
Message fast transmit interval : 6
Maximum transmit credit   : 5
Reinitialisation delay    : 2
MED Enabled                : N
Device Type                : Not Defined
Traffic statistics        :
Total frames transmitted   : 5
Total entries aged         : 0
Total frames received      : 0
Total error frames received : 0
Total frames discarded     : 0
Total discarded TLVs      : 0
Total unrecognised TLVs   : 0
```

## Non-Tpmr-Bridge

The below configurations should be followed for each machines.

#configure terminal	Enter configure mode.
(config)#bridge 1 protocol ieee vlan-bridge	Configure an IEEE VLAN-aware bridge.
(config)#vlan database	Enter VLAN configure mode.
(config-vlan)#vlan 2 bridge 1 state enable	Configure a VLAN and add it to the bridge.
(config-vlan)#exit	Exit the VLAN configuration mode.
(config)#interface eth1	Enter interface mode.
(config-if)#switchport	Set switching characteristics on the port.
(config-if)#bridge-group 1	Associate the interface to the bridge.
(config-if)#lldp-agent non-tpmr-bridge	Enter into the Non tpmr Bridge agent
(if-lldp-agent)#set lldp enable txrx	Enable an LLDP agent on the port.
(if-lldp-agent)#set lldp chassis-id-tlv ip-address	Configure the subtype for chassis-id TLV
(if-lldp-agent)#set lldp port-id-tlv mac-address	Configure the subtype for port-id TLV
(if-lldp-agent)# lldp tlv basic-mgmt port-description select	Enable the port-description TLV to be transmitted on the port
(if-lldp-agent)# lldp tlv basic-mgmt system-name select	Enable the system-name TLV to be transmitted on the port
(if-lldp-agent)# lldp tlv basic-mgmt system-capabilities select	Enable the system-capabilities TLV to be transmitted on the port
(if-lldp-agent)# lldp tlv basic-mgmt system-description select	Enable the system-description TLV to be transmitted on the port
(if-lldp-agent)# lldp tlv basic-mgmt management-address select	Enable the management-address TLV to be transmitted on the port
(if-lldp-agent)# lldp tlv ieee-8021-org-specific port-vlanid select	Enable the VLAN-id TLV to be transmitted on the port
(if-lldp-agent)# lldp tlv ieee-8021-org-specific vlan-name select	Enable the VLAN-NAME TLV to be transmitted on the port
(if-lldp-agent)# lldp tlv ieee-8021-org-specific port-ptcl-vlanid select	Enable the Port and Protocol VLAN id TLV to be transmitted on the port
(if-lldp-agent)# lldp tlv ieee-8021-org-specific ptcl-identity select	Enable the Protocol Identity TLV to be transmitted on the port
(if-lldp-agent)# lldp tlv ieee-8021-org-specific vid-digest select	Enable the VID Usage Digest TLV to be transmitted on the port
(if-lldp-agent)# lldp tlv ieee-8021-org-specific mgmt-vid select	Enable the Management VID TLV to be transmitted on the port

(if-lldp-agent)# lldp tlv ieee-8021-org-specific link-agg select	Enable the Link Aggregation TLV to be transmitted on the port
(if-lldp-agent)# lldp tlv ieee-8023-org-specific mac-phy select	Enable the MAC/PHY Configuration/Status TLV to be transmitted on the port
(if-lldp-agent)# lldp tlv ieee-8023-org-specific max-mtu-size select	Enable the Maximum Frame Size TLV to be transmitted on the port
(if-lldp-agent)#set lldp timer msg-fast-tx 5	Defines the time interval during fast transmission periods
(if-lldp-agent)#set lldp tx-fast-init 6	Defines the number of LLD PDUs that are transmitted during a fast transmission period
(if-lldp-agent)#exit	Exit the lldp agent mode
(config-if)#commit	Commit the transaction.
(config-if)#exit	Exit interface mode.

## Validation

### 1. Verify the LLDP configurations in the local machine

```
#show running-config lldp
!
interface eth1
lldp-agent non-tpmr-bridge
set lldp enable txrx
set lldp chassis-id-tlv ip-address
set lldp port-id-tlv mac-address
lldp tlv basic-mgmt port-description select
lldp tlv basic-mgmt system-name select
lldp tlv basic-mgmt system-description select
lldp tlv basic-mgmt system-capabilities select
lldp tlv basic-mgmt management-address select
lldp tlv ieee-8021-org-specific port-vlanid select
lldp tlv ieee-8021-org-specific port-ptcl-vlanid select
lldp tlv ieee-8021-org-specific vlan-name select
lldp tlv ieee-8021-org-specific ptcl-identity select
lldp tlv ieee-8021-org-specific vid-digest select
lldp tlv ieee-8021-org-specific mgmt-vid select
lldp tlv ieee-8021-org-specific link-agg select
lldp tlv ieee-8023-org-specific mac-phy select
lldp tlv ieee-8023-org-specific max-mtu-size select
set lldp timer msg-fast-tx 5
set lldp tx-fast-init 6
!
```

### 2. Verify the LLDP port statistics

```
#show lldp interface eth1 non-tpmr-bridge

Agent Mode                : Non-TPMR-bridge
Enable (tx/rx)           : Y/Y
Message fast transmit time : 5
Message transmit interval : 30
Message fast transmit interval : 6
Maximum transmit credit   : 5
Reinitialisation delay    : 2
```

```

MED Enabled                : N
Device Type                : Not Defined
Traffic statistics         :
Total frames transmitted   : 6
Total entries aged         : 0
Total frames received      : 0
Total error frames received : 0
Total frames discarded     : 0
Total discarded TLVs      : 0
Total unrecognised TLVs   : 0
    
```

## LLDPV2 (Global Mode TLV)

LLDPv2 TLVs can be configured globally, making it applicable for all interfaces where LLDP is enabled.

### Topology

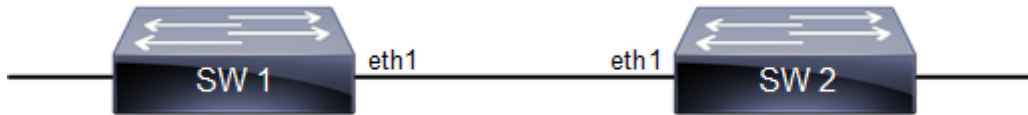

Figure 7-17: LLDP topology

### SW1

SW1#configure terminal	Enter Configure mode
SW1(config)#lldp tlv-select basic-mgmt port-description	Enable LLDP port description TLV in global mode
SW1(config)#lldp tlv-select basic-mgmt system-name	Enable LLDP system name TLV in global mode
SW1(config)#lldp tlv-select basic-mgmt system-capabilities	Enable LLDP system capabilities TLV in global mode
SW1(config)#lldp tlv-select basic-mgmt system-description	Enable LLDP system description TLV in global mode
SW1(config)#lldp tlv-select basic-mgmt management-address	Enable LLDP port description TLV in global mode
SW1(config)#interface eth1	Enter interface mode
SW1(config-if)#lldp-agent	Enter LLDP interface mode
SW1(if-lldp-agent)#set lldp enable txrx	Enable LLDP TLV transmit and receive for the nearest bridge
SW1(if-lldp-agent)#exit	Exit LLDP mode
SW1(config-if)#commit	Commit the transaction.
SW1(config-if)#exit	Exit the configure mode

SW2

SW2(config)#lldp tlv-select basic-mgmt port-description	Enable LLDP port description TLV in global mode
SW2(config)#lldp tlv-select basic-mgmt system-name	Enable LLDP system name TLV in global mode
SW2(config)#lldp tlv-select basic-mgmt system-capabilities	Enable LLDP system capabilities TLV in global mode
SW2(config)#lldp tlv-select basic-mgmt system-description	Enable LLDP system description TLV in global mode
SW2(config)#lldp tlv-select basic-mgmt management-address	Enable LLDP management address TLV in global mode
SW2(config)#interface eth1	Enter interface mode
SW2(config-if)#lldp-agent	Enter LLDP interface mode
SW2(if-lldp-agent)#set lldp enable txrx	Enable LLDP TLV transmit and receive for the nearest bridge
SW2(if-lldp-agent)#exit	Exit LLDP mode
SW2(config-if)#commit	Commit the transaction.
SW2(config)#end	Exit the configure mode

Validation

```
SW1#show running-config lldp
!
lldp tlv-select basic-mgmt port-description
lldp tlv-select basic-mgmt system-name
lldp tlv-select basic-mgmt system-capabilities
lldp tlv-select basic-mgmt system-description
lldp tlv-select basic-mgmt management-address
!
```

```
SW1#show lldp neighbors
  Loc PortID      Rem Host Name      Rem Chassis Id      Rem Port Id      Agent Mode
-----
Eth1              OcNOS              cc37.ab56.6d80      cc37.abb.ed81     Nearest bridge
```

```
SW1#show lldp neighbors detail
-----
--
Nearest bridge Neighbors
Interface Name      : eth1
Mandatory TLVs
Chassis id type     : MAC address [cc37.ab56.6d80]
Port id type        : MAC address [cc37.abb.ed81]
```

```
Time to live                : 121
Basic Management TLVs
System Name                  : SW2
System Description           : Hardware Model:CEL_BELGITE_E1070, Software
version: Oc
NOS,6.3.2.47
Port Description             : eth1
Remote System Capabilities  : Bridge
                             Router
Capabilities Enabled         : Router
Management Address          : MAC Address [cc37.abbb.ed81]
Interface Number subtype    : ifindex
Interface Number            : 10046
OID Number                   : 0
802.1 Org specific TLVs
Port vlan id                 : 0
Port & Protocol vlan id     : 0
Remote Configured VLANs     : None
Remote Protocols Advertised: None
Remote VID Usage Digest     : 0
Remote Management Vlan      : 0
Link Aggregation Capability: not capable of being aggregated
Link Aggregation Status     : not currently in aggregation
Link Aggregation Port ID    :
802.3 Org specific TLVs
AutoNego Support             : Not-Supported
AutoNego Status              : Disabled
AutoNego Capability         : 0
Operational MAU Type        : 0 [unknown]
Max Frame Size               :
SW1#
```

---

## LLDP-MED

LLDP extensions and behavior requirements are described specifically in the areas of network Configuration and policy, device location (including for Emergency Call Service / E911), Power over Ethernet management, and inventory management.

Based on the device type, different TLVs are advertised by the Station.

---

## LLDP-MED Network Connectivity Device

LLDP-MED Network Connectivity Devices, as defined in this Standard, provide access to the IEEE 802 based LAN infrastructure for LLDP-MED Endpoint Devices. An LLDP-MED Network Connectivity Device is a LAN access device based on any of the following technologies:

- LAN Switch/Router
- IEEE 802.1 Bridge
- IEEE 802.3 Repeater (included for historical reasons)
- IEEE 802.11 Wireless Access Point
- Any device that supports the IEEE 802.1AB and MED extensions defined by this Standard and can relay IEEE 802 frames via any method.

---

## Configuration Command

```
set lldp med-devtype net-connect
```

---

## LLDP-MED Generic Endpoint (Class 1)

The LLDP-MED Generic Endpoint (Class I) definition is applicable to all endpoint products that require the base LLDP discovery services, however do not support IP media or act as an end-user communication appliance. Such devices may include (but are not limited to) IP Communication Controllers, other communication related servers, or any device requiring basic services.

## Configuration Command

```
set lldp med-devtype ep-class1
```

---

## LLDP-MED Generic Endpoint (Class 2)

The LLDP-MED Media Endpoint (Class II) definition is applicable to all endpoint products that have IP media capabilities however may or may not be associated with a particular end user. Capabilities include all of the capabilities defined for the previous Generic Endpoint Class (Class I), and are extended to include aspects related to media streaming. Example product categories expected to adhere to this class include (but are not limited to) Voice / Media Gateways, Conference Bridges, Media Servers, and similar

## Configuration Command

```
set lldp med-devtype ep-class2
```

---

## LLDP-MED Generic Endpoint (Class 3)

The LLDP-MED Communication Endpoint (Class III) definition is applicable to all endpoint products that act as end user communication appliances supporting IP media. Capabilities include all of the capabilities defined for the previous Generic Endpoint (Class I) and Media Endpoint (Class II) classes, and are extended to include aspects related to end user devices. Example product categories expected to adhere to this class include (but are not limited to) end user communication appliances, such as IP Phones, PC-based softphones, or other communication appliances that directly support the end user.

## Configuration Command

```
set lldp med-devtype ep-class3
```

---

## Topology

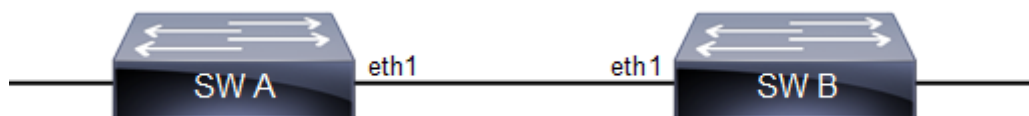

---

## SW A

## Link Layer Discovery Protocol Configuration

<code>#configure terminal</code>	Enter configure mode.
<code>(config)#bridge 1 protocol ieee vlan-bridge</code>	Configure an IEEE VLAN-aware bridge.
<code>(config)#vlan database</code>	Enter VLAN configure mode.
<code>(config-vlan)#vlan 2 bridge 1 state enable</code>	Configure a VLAN and add it to the bridge.
<code>(config-vlan)#exit</code>	Exit the VLAN configuration mode.
<code>(config)#interface eth1</code>	Enter interface mode.
<code>(config-if)#switchport</code>	Set switching characteristics on the port.
<code>(config-if)#bridge-group 1</code>	Associate the interface to the bridge.
<code>(config-if)#lldp-agent</code>	Enter into the default agent
<code>(if-lldp-agent)#set lldp enable txrx</code>	Enable an LLDP agent on the port.
<code>(if-lldp-agent)# lldp tlv med media-capabilities select</code>	Enable the med media capabilities TLV to be transmitted on the port
<code>(if-lldp-agent)# lldp tlv med network-policy select</code>	Enable the med network policy TLV to be transmitted on the port
<code>(if-lldp-agent)# lldp tlv med location select</code>	Enable the med location TLV to be transmitted on the port
<code>(if-lldp-agent)#exit</code>	Exit the lldp agent mode
<code>(if-config-if)#lldp-agent customer-bridge</code>	Enter into the customer-bridge agent
<code>(if-lldp-agent)#set lldp enable txrx</code>	Enable an LLDP agent on the port.
<code>(if-lldp-agent)# lldp tlv med media-capabilities select</code>	Enable the med media capabilities TLV to be transmitted on the port
<code>(if-lldp-agent)# lldp tlv med network-policy select</code>	Enable the med network policy TLV to be transmitted on the port
<code>(if-lldp-agent)# lldp tlv med location select</code>	Enable the med location TLV to be transmitted on the port
<code>(if-lldp-agent)#exit</code>	Exit the lldp agent mode
<code>(config-if)#lldp-agent non-tpmr-bridge</code>	Enter into the non-tpmr-bridge agent
<code>(if-lldp-agent)#set lldp enable txrx</code>	Enable an LLDP agent on the port.
<code>(if-lldp-agent)# lldp tlv med media-capabilities select</code>	Enable the med media capabilities TLV to be transmitted on the port
<code>(if-lldp-agent)# lldp tlv med network-policy select</code>	Enable the med network policy TLV to be transmitted on the port



(if-lldp-agent)# lldp tlv med location select	Enable the med location TLV to be transmitted on the port
(if-lldp-agent)#exit	Exit the lldp agent mode
(config-if)#set lldp med-devtype net-connect	Configure the med device type
(config-if)#exit	Exit interface mode.
(config)#commit	Commit the transaction.

## SW B

#configure terminal	Enter configure mode.
(config)#bridge 1 protocol ieee vlan-bridge	Configure an IEEE VLAN-aware bridge.
(config)#vlan database	Enter VLAN configure mode.
(config-vlan)#vlan 2 bridge 1 state enable	Configure a VLAN and add it to the bridge.
(config-vlan)#exit	Exit the VLAN configuration mode.
(config)#interface eth1	Enter interface mode.
(config-if)#switchport	Set switching characteristics on the port.
(config-if)#bridge-group 1	Associate the interface to the bridge.
(config-if)#lldp-agent	Enter into the default agent
(if-lldp-agent)#set lldp enable txrx	Enable an LLDP agent on the port.
(if-lldp-agent)#exit	Exit the lldp agent mode
(config-if)#lldp-agent customer-bridge	Enter into the customer-bridge agent
(if-lldp-agent)#set lldp enable txrx	Enable an LLDP agent on the port.
(if-lldp-agent)#exit	Exit the lldp agent mode
(config-if)#lldp-agent non-tpmr-bridge	Enter into the non-tpmr-bridge agent
(if-lldp-agent)#set lldp enable txrx	Enable an LLDP agent on the port.
(if-lldp-agent)#exit	Exit the lldp agent mode
(config-if)#set lldp med-devtype {ep-class1 ep-class2 ep-class3}	Configure the med device type
(config-if)#exit	Exit interface mode.
(config)#commit	Commit the transaction.

## Validation

1. Verify the LLDP configurations on Machine A

```
#show running-config lldp
!
interface eth0
  lldp-agent
```

```
!  
interface eth1  
lldp-agent  
set lldp enable txrx  
lldp tlv med media-capabilities select  
lldp tlv med network-policy select  
lldp tlv med location select  
set lldp med-devtype net-connect  
lldp-agent non-tpmr-bridge  
set lldp enable txrx  
lldp tlv med media-capabilities select  
lldp tlv med network-policy select  
lldp tlv med location select  
lldp-agent customer-bridge  
set lldp enable txrx  
lldp tlv med media-capabilities select  
lldp tlv med network-policy select  
lldp tlv med location select  
!
```

### 2. Verify the LLDP port statistics on machine A

```
#show lldp interface eth1
```

```
Agent Mode                : Customer-bridge  
  Enable (tx/rx)          : Y/Y  
  Message fast transmit time : 1  
  Message transmit interval : 30  
  Message fast transmit interval : 4  
  Maximum transmit credit   : 5  
  Reinitialisation delay    : 2  
  MED Enabled              : Y  
  Device Type              : Network Connectivity  
  Traffic statistics        :  
    Total frames transmitted : 33  
    Total entries aged       : 0  
    Total frames received    : 34  
    Total error frames received : 0  
    Total frames discarded    : 0  
    Total discarded TLVs     : 0  
    Total unrecognised TLVs  : 0  
Agent Mode                : Non-TPMR-bridge  
  Enable (tx/rx)          : Y/Y  
  Message fast transmit time : 1  
  Message transmit interval : 30  
  Message fast transmit interval : 4  
  Maximum transmit credit   : 5  
  Reinitialisation delay    : 2  
  MED Enabled              : Y  
  Device Type              : Network Connectivity  
  Traffic statistics        :  
    Total frames transmitted : 30  
    Total entries aged       : 0  
    Total frames received    : 31  
    Total error frames received : 0  
    Total frames discarded    : 0  
    Total discarded TLVs     : 0
```

```
Total unrecognised TLVs      : 0
Agent Mode                    : Nearest bridge
Enable (tx/rx)                : Y/Y
Message fast transmit time    : 1
Message transmit interval     : 30
Message fast transmit interval : 4
Maximum transmit credit       : 5
Reinitialisation delay        : 2
MED Enabled                    : Y
Device Type                    : Network Connectivity
Traffic statistics             :
Total frames transmitted      : 30
Total entries aged            : 0
Total frames received         : 31
Total error frames received   : 0
Total frames discarded        : 0
Total discarded TLVs         : 0
Total unrecognised TLVs      : 0
```

```
#show lldp interface eth1 non-tpmr-bridge
```

```
Agent Mode                    : Non-TPMR-bridge
Enable (tx/rx)                : Y/Y
Message fast transmit time    : 1
Message transmit interval     : 30
Message fast transmit interval : 4
Maximum transmit credit       : 5
Reinitialisation delay        : 2
MED Enabled                    : Y
Device Type                    : Network Connectivity
Traffic statistics             :
Total frames transmitted      : 32
Total entries aged            : 0
Total frames received         : 33
Total error frames received   : 0
Total frames discarded        : 0
Total discarded TLVs         : 0
Total unrecognised TLVs      : 0
```

### 3. Verify the LLDP configurations for end device ep-class3 on machine B

```
#show running-config lldp
!
interface eth0
 lldp-agent
!
interface eth1
 lldp-agent
  set lldp enable txrx
  set lldp chassis-id-tlv ip-address
set lldp med-devtype ep-class3
lldp-agent non-tpmr-bridge
  set lldp enable txrx
  set lldp chassis-id-tlv ip-address
lldp-agent customer-bridge
```

```
set lldp enable txrx
set lldp chassis-id-tlv ip-address
!
```

#### 4. Verify the LLDP port statistics on machine B

```
#show lldp interface eth1
Agent Mode : Customer-bridge
Enable (tx/rx) : Y/Y
Message fast transmit time : 1
Message transmit interval : 30
Message fast transmit interval : 4
Maximum transmit credit : 5
Reinitialisation delay : 2
MED Enabled : Y
Device Type : End Point Class-3
Traffic statistics :
Total frames transmitted : 0
Total entries aged : 0
Total frames received : 8
Total error frames received : 0
Total frames discarded : 0
Total discarded TLVs : 0
Total unrecognised TLVs : 0
Agent Mode : Non-TPMR-bridge
Enable (tx/rx) : Y/Y
Message fast transmit time : 1
Message transmit interval : 30
Message fast transmit interval : 4
Maximum transmit credit : 5
Reinitialisation delay : 2
MED Enabled : Y
Device Type : End Point Class-3
Traffic statistics :
Total frames transmitted : 0
Total entries aged : 0
Total frames received : 8
Total error frames received : 0
Total frames discarded : 0
Total discarded TLVs : 0
Total unrecognised TLVs : 0
Agent Mode : Nearest bridge
Enable (tx/rx) : Y/Y
Message fast transmit time : 1
Message transmit interval : 30
Message fast transmit interval : 4
Maximum transmit credit : 5
Reinitialisation delay : 2
MED Enabled : Y
Device Type : End Point Class-3
Traffic statistics :
Total frames transmitted : 0
Total entries aged : 0
Total frames received : 8
Total error frames received : 0
Total frames discarded : 0
Total discarded TLVs : 0
```

Total unrecognised TLVs : 0



## CHAPTER 8 MLAG Configuration

This chapter contains a complete example of Multi-Chassis Link Aggregation (MLAG) configuration.

MLAG (also called DRNI, Distributed Resilient Network Interconnect) expands the concept of link aggregation so that it provides node-level redundancy by allowing two or more nodes to share a common LAG endpoint. MLAG emulates multiple nodes to represent as a single logical node to the remote node running link aggregation. As a result even if one of the nodes is down there exists a path to reach the destination through the other nodes.

Note: MLAG is compatible only with a RSTP VLAN-aware bridge or a spanning tree disabled bridge.

Note: All MLAG nodes must have the same MAC table size as specified by each node's switching ASIC forwarding profile limit.

Note: More than one IDL is not supported in single node under mcec configuration.

Note: IDL and IDP configurations are allowed together, IDP will provide a Layer 3 communication path which will be used as a Secondary test to determine the state of MLAG Peer, however It is recommended not to use IDP without IDL for MLAG Active-Active

### Dynamic Configuration

#### Topology

As shown in [Figure 8-18](#), switches 3 and 4 form an MLAG domain. Switches 3 and 4 are a single logical switch to switches 1 and 2. Even if either switch 3 or 4 is down, there exists a path to reach other destinations.

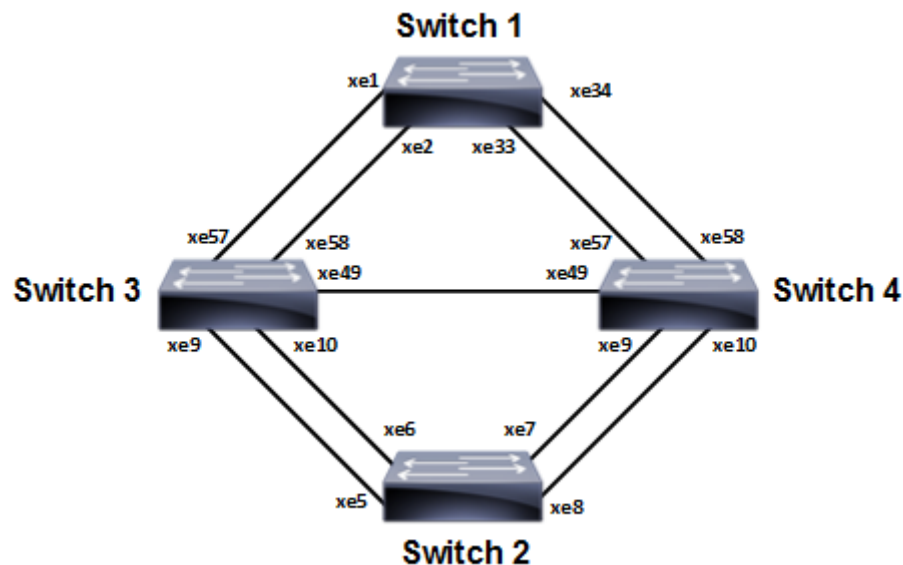

Figure 8-18: MLAG Topology

#### Switch 1

#configure terminal	Enter configure mode.
(config)#bridge 1 protocol rstp vlan-bridge	Create RSTP bridge 1.

## MLAG Configuration

<code>(config)#vlan database</code>	Enter vlan database mode.
<code>(config-vlan)#vlan 2 bridge 1 state enable</code>	Create VLAN 2.
<code>(config-vlan)#exit</code>	Exit vlan database mode.
<code>(config)#interface po2</code>	Enter interface mode.
<code>(config-if)#switchport</code>	Configure the interface as Layer 2
<code>(config-if)#bridge-group 1</code>	Associate the interface with bridge group 1.
<code>(config-if)#switchport mode trunk</code>	Set the switching characteristics of this interface to trunk mode.
<code>(config-if)#switchport trunk allowed vlan all</code>	Enable all VLAN identifiers on this interface.
<code>(config-if)#exit</code>	Exit interface mode.
<code>(config)#interface xe1</code>	Enter interface mode.
<code>(config-if)#channel-group 2 mode active</code>	Add this interface to channel group 2 and enable link aggregation so that it can be selected for aggregation by the local system.
<code>(config-if)#exit</code>	Exit interface mode.
<code>(config)#interface xe2</code>	Enter interface mode.
<code>(config-if)#channel-group 2 mode active</code>	Add this interface to channel group 2 and enable link aggregation so that it can be selected for aggregation by the local system.
<code>(config-if)#exit</code>	Exit interface mode.
<code>(config)#interface xe33</code>	Enter interface mode.
<code>(config-if)#channel-group 2 mode active</code>	Add this interface to channel group 2 and enable link aggregation so that it can be selected for aggregation by the local system.
<code>(config-if)#exit</code>	Exit interface mode.
<code>(config)#interface xe34</code>	Enter interface mode.
<code>(config-if)#channel-group 2 mode active</code>	Add this interface to channel group 2 and enable link aggregation so that it can be selected for aggregation by the local system.
<code>(config-if)#exit</code>	Exit interface mode.
<code>(config)#commit</code>	Commit the transaction.

## Switch 2

<code>#configure terminal</code>	Enter configure mode.
<code>(config)#bridge 1 protocol rstp vlan-bridge</code>	Create RSTP bridge 1.
<code>(config)#vlan database</code>	Enter vlan database mode.
<code>(config-vlan)#vlan 2 bridge 1 state enable</code>	Create VLAN 2.
<code>(config-vlan)#exit</code>	Exit vlan database mode.
<code>(config)#interface po1</code>	Enter interface mode.
<code>(config-if)#switchport</code>	Configure the interface as Layer 2



<code>(config-if)#bridge-group 1</code>	Associate the interface with bridge group 1.
<code>(config-if)#switchport mode trunk</code>	Set the switching characteristics of this interface to trunk mode.
<code>(config-if)#switchport trunk allowed vlan all</code>	Enable all VLAN identifiers on this interface.
<code>(config-if)#exit</code>	Exit interface mode.
<code>(config)#interface xe5</code>	Enter interface mode.
<code>(config-if)#channel-group 1 mode active</code>	Add this interface to channel group 1 and enable link aggregation so that it can be selected for aggregation by the local system.
<code>(config-if)#exit</code>	Exit interface mode.
<code>(config)#interface xe6</code>	Enter interface mode.
<code>(config-if)#channel-group 1 mode active</code>	Add this interface to channel group 1 and enable link aggregation so that it can be selected for aggregation by the local system.
<code>(config-if)#exit</code>	Exit interface mode.
<code>(config)#interface xe7</code>	Enter interface mode.
<code>(config-if)#channel-group 1 mode active</code>	Add this interface to channel group 1 and enable link aggregation so that it can be selected for aggregation by the local system.
<code>(config-if)#exit</code>	Exit interface mode.
<code>(config)#interface xe8</code>	Enter interface mode.
<code>(config-if)#channel-group 1 mode active</code>	Add this interface to channel group 1 and enable link aggregation so that it can be selected for aggregation by the local system.
<code>(config-if)#exit</code>	Exit interface mode.
<code>(config)#commit</code>	Commit the transaction.

### Switch 3

<code>#configure terminal</code>	Enter configure mode.
<code>(config)#bridge 1 protocol rstp vlan-bridge</code>	Create RSTP bridge 1.
<code>(config)#vlan database</code>	Enter vlan database mode.
<code>(config-vlan)#vlan 2 bridge 1 state enable</code>	Create VLAN 2.
<code>(config-vlan)#exit</code>	Exit vlan database mode.
<code>(config)#interface mlag1</code>	Enter interface mode.
<code>(config-if)#switchport</code>	Configure the interface as Layer 2
<code>(config-if)#bridge-group 1</code>	Associate the interface with bridge group 1.
<code>(config-if)#switchport mode trunk</code>	Set the switching characteristics of this interface to trunk mode.
<code>(config-if)#switchport trunk allowed vlan all</code>	Enable all VLAN identifiers on this interface.
<code>(config-if)#exit</code>	Exit interface mode.

## MLAG Configuration

<code>(config)#interface mlag2</code>	Enter interface mode.
<code>(config-if)#switchport</code>	Configure the interface as Layer 2
<code>(config-if)#bridge-group 1</code>	Associate the interface with bridge group 1.
<code>(config-if)#switchport mode trunk</code>	Set the switching characteristics of this interface to trunk mode.
<code>(config-if)#switchport trunk allowed vlan all</code>	Enable all VLAN identifiers on this interface.
<code>(config-if)#exit</code>	Exit interface mode.
<code>(config)#interface po1</code>	Enter interface mode.
<code>(config-if)#switchport</code>	Configure the interface as Layer 2
<code>(config-if)#mlag 1</code>	Enabling Mlag group number
<code>(config-if)#exit</code>	Exit interface mode.
<code>(config)#interface po2</code>	Enter interface mode.
<code>(config-if)#switchport</code>	Configure the interface as Layer 2
<code>(config-if)#mlag 2</code>	enabling Mlag group number
<code>(config-if)#exit</code>	Exit interface mode.
<code>(config)#interface xe9</code>	Enter interface mode.
<code>(config-if)#channel-group 1 mode active</code>	Add this interface to channel group 1 and enable link aggregation so that it can be selected for aggregation by the local system.
<code>(config-if)#exit</code>	Exit interface mode.
<code>(config)#interface xe57</code>	Enter interface mode.
<code>(config-if)#channel-group 2 mode active</code>	Add this interface to channel group 2 and enable link aggregation so that it can be selected for aggregation by the local system.
<code>(config-if)#exit</code>	Exit interface mode.
<code>(config)#interface xe58</code>	Enter interface mode.
<code>(config-if)#channel-group 2 mode active</code>	Add this interface to channel group 2 and enable link aggregation so that it can be selected for aggregation by the local system.
<code>(config-if)#exit</code>	Exit interface mode.
<code>(config)#interface xe10</code>	Enter interface mode.
<code>(config-if)#channel-group 1 mode active</code>	Add this interface to channel group 1 and enable link aggregation so that it can be selected for aggregation by the local system.
<code>(config-if)#exit</code>	Exit interface mode.
<code>(config)#interface xe49</code>	Enter interface mode.
<code>(config-if)#switchport</code>	Configure the interface as Layer 2
<code>(config-if)#exit</code>	Exit interface mode.
<code>(cosnfig)#commit</code>	Commit the transaction.
<code>(config)#mcec domain configuration</code>	Entering MCEC mode

(config-mcec-domain)#domain-address 1111.2222.3333	Domain address for the mlag domain
(config-mcec-domain)#intra-domain link xe49	Intra domain line between mlag domain
(config-mcec-domain)#domain-system-number 1	Number to identify the node in a domain
(config-mcec-domain)#exit	Exit MCEC mode
(config)#commit	Commit the transaction.

## Switch 4

#configure terminal	Enter configure mode.
(config)#bridge 1 protocol rstp vlan-bridge	Create RSTP bridge 1.
(config)#vlan database	Enter vlan database mode.
(config-vlan)#vlan 2 bridge 1 state enable	Create VLAN 2.
(config-vlan)#exit	Exit vlan database mode.
(config-if)#switchport	Configure the interface as Layer 2
(config-if)#bridge-group 1	Associate the interface with bridge group 1.
(config-if)#switchport mode trunk	Set the switching characteristics of this interface to trunk mode.
(config-if)#switchport trunk allowed vlan all	Enable all VLAN identifiers on this interface.
(config-if)#exit	Exit interface mode.
(config)#interface mlag2	Enter interface mode.
(config-if)#switchport	Configure the interface as Layer 2
(config-if)#bridge-group 1	Associate the interface with bridge group 1.
(config-if)#switchport mode trunk	Set the switching characteristics of this interface to trunk mode.
(config-if)#switchport trunk allowed vlan all	Enable all VLAN identifiers on this interface.
(config-if)#exit	Exit interface mode.
(config)#interface po1	Enter interface mode.
(config-if)#switchport	Configure the interface as Layer 2
(config-if)#mlag 1	Enabling Mlag group number
(config-if)#exit	Exit interface mode.
(config)#interface po2	Enter interface mode.
(config-if)#switchport	Configure the interface as Layer 2
(config-if)#mlag 2	enabling Mlag group number
(config-if)#exit	Exit interface mode.
(config)#interface xe9	Enter interface mode.
(config-if)#channel-group 1 mode active	Add this interface to channel group 1 and enable link aggregation so that it can be selected for aggregation by the local system.

## MLAG Configuration

---

(config-if)#exit	Exit interface mode.
(config)#interface xe10	Enter interface mode.
(config-if)#channel-group 1 mode active	Add this interface to channel group 1 and enable link aggregation so that it can be selected for aggregation by the local system.
(config-if)#exit	Exit interface mode.
(config)#interface xe57	Enter interface mode.
(config-if)#channel-group 2 mode active	Add this interface to channel group 2 and enable link aggregation so that it can be selected for aggregation by the local system.
(config-if)#exit	Exit interface mode.
(config)#interface xe58	Enter interface mode.
(config-if)#channel-group 2 mode active	Add this interface to channel group 2 and enable link aggregation so that it can be selected for aggregation by the local system.
(config-if)#exit	Exit interface mode.
(config)#interface xe49	Enter interface mode.
(config-if)#switchport	Configure the interface as Layer 2
(config-if)#exit	Exit interface mode.
(config)#commit	Commit the transaction.
(config)#mcec domain configuration	Entering MCEC mode
(config-mcec-domain)#domain-address 1111.2222.3333	Domain address for the Mlag domain
(config-mcec-domain)#intra-domain link xe49	Intra domain Link between Mlag domains
(config-mcec-domain)#domain-system-number 2	Number to identify the node in domain
(config-mcec-domain)#exit	Exit MCEC mode
(config)#commit	Commit the transaction.

---

## Validation

### Switch 3

```
#sh mlag domain details
```

```
-----  
Domain Configuration  
-----
```

```
Domain System Number      : 1  
Domain Address            : 1111.2222.3333  
Domain Priority           : 1000  
Intra Domain Interface    : xe49
```

---

```
Hello RCV State           : Current
Hello Periodic Timer State : Fast Periodic
Domain Sync               : IN_SYNC
Neigh Domain Sync        : IN_SYNC
Domain Adjacency         : UP
```

```
-----
MLAG Configuration
-----
```

## MLAG-1

```
Mapped Aggregator       : po1
Admin Key               : 16385
Oper Key                : 16385
Physical properties Digest : dd 9c f 76 dd b6 5f 2f eb a1 d3 bb 8d 96 fc 82

Neigh Admin Key        : 32769
Neigh Physical Digest  : dd 9c f 76 dd b6 5f 2f eb a1 d3 bb 8d 96 fc 82
Info RCV State         : Current
Info Periodic Time State : Standby
Mlag Sync              : IN_SYNC
Mode                   : Active-Active
Current Mlag State     : Active
```

## MLAG-2

```
Mapped Aggregator       : po2
Admin Key               : 16386
Oper Key                : 16386
Physical properties Digest : dd 9c f 76 dd b6 5f 2f eb a1 d3 bb 8d 96 fc 82

Neigh Admin Key        : 32770
Neigh Physical Digest  : dd 9c f 76 dd b6 5f 2f eb a1 d3 bb 8d 96 fc 82
Info RCV State         : Current
Info Periodic Time State : Standby
Mlag Sync              : IN_SYNC
Mode                   : Active-Active
Current Mlag State     : Active
```

```
#sh etherchannel summary
% Aggregator po1 0
% Aggregator Type: Layer2
% Admin Key: 16385 - Oper Key 16385
% Link: xe57 (5057) sync: 1 (Mlag-active-link)
% Link: xe58 (5058) sync: 1 (Mlag-active-link)
% Aggregator po2 0
% Aggregator Type: Layer2
% Admin Key: 16386 - Oper Key 16386
% Link: xe9 (5009) sync : 1 (Mlag-active-link)
```

## MLAG Configuration

---

% Link: xe10 (5010) sync: 1 (Mlag-active-link)

#sh mlag 1 detail

MLAG-1

```
Mapped Aggregator      : pol
Admin Key              : 16385
Oper Key               : 16385
Physical properties Digest : dd 9c f 76 dd b6 5f 2f eb a1 d3 bb 8d 96 fc 82

Neigh Admin Key       : 32769
Neigh Physical Digest : dd 9c f 76 dd b6 5f 2f eb a1 d3 bb 8d 96 fc 82
Info RCV State        : Current
Info Periodic Time State : Standby
Total Bandwidth       : 20g
Mlag Sync              : IN_SYNC
Mode                   : Active-Active
Current Mlag State    : Active
```

sh mcec statistics

Unknown MCCPDU received on the system : 0

-----  
IDP xe49  
-----

```
Valid RX Hello PDUs      : 398
Valid TX Hello PDUs      : 417
Valid RX Info PDUs       : 16
Valid TX Info PDUs       : 6

Valid RX Mac Sync PDUs   : 3
Valid TX Mac Sync PDUs   : 4
```

MLAG 1

```
Valid RX Info PDUs      : 8
Valid TX Info PDUs      : 3
```

MLAG 2

```
Valid RX Info PDUs      : 8
Valid TX Info PDUs      : 3
```

sh mlag domain summary

-----  
Domain Configuration  
-----

```
Domain System Number    : 1
Domain Address           : 1111.2222.3333
```

---

Domain Priority : 1000  
Intra Domain Interface : xe49  
Domain Adjacency : UP

-----  
MLAG Configuration  
-----

## MLAG-1

Mapped Aggregator : po1  
Physical properties Digest : dd 9c f 76 dd b6 5f 2f eb a1 d3 bb 8d 96 fc 82  
Total Bandwidth : 40g  
Mlag Sync : IN\_SYNC  
Mode : Active-Active  
Current Mlag State : Active

## MLAG-2

Mapped Aggregator : po2  
Physical properties Digest : dd 9c f 76 dd b6 5f 2f eb a1 d3 bb 8d 96 fc 82  
Total Bandwidth : 40g  
Mlag Sync : IN\_SYNC  
Mode : Active-Active  
Current Mlag State : Active





(config-if)#exit	Exit the interface mode
(config)#interface xe2	Enter the interface mode
(config-if)# static-channel-group 1	Map static channel to the interface
(config-if)#exit	Exit the interface mode
(config)#interface xe9	Enter the interface mode
(config-if)# static-channel-group 1	Map static channel to the interface
(config-if)#exit	Exit the interface mode
(config)#interface xe11	Enter the interface mode
(config-if)# static-channel-group 1	Map static channel to the interface
(config-if)#exit	Exit the interface mode
(config)#interface xe22	Enter the interface mode
(config-if)# static-channel-group 1	Map static channel to the interface
(config-if)#exit	Exit the interface mode
(config)#interface xe47	Enter the interface mode
(config-if)#switchport	Make the interface as switch port
(config-if)# bridge-group 1 spanning-tree disable	Disable the spanning-tree for the interface
(config-if)#switchport mode hybrid	Configure the mode as hybrid
(config-if)#switchport hybrid allowed vlan all	Configure allowed VLAN all on the interface
(config-if)#exit	Exit the interface mode
(config)#commit	Commit the transaction.

## TOR1

#configure terminal	Enter configure mode.
(config)#hostname TOR1	Configuring host name
(config)#bridge 1 protocol provider-rstp edge	Create a PROVIDER-RSTP EDGE bridge
(config)#vlan database	Enter vlan database mode.
(config-vlan)#vlan 2 type customer bridge 1 state enable	Configure VLAN for the bridge
(config-vlan)# vlan 200 type service point-point bridge 1 state enable	Configure SVLAN for the bridge
(config-vlan)#exit	Exit vlan database mode.
(config)# #cvlan registration table map1 bridge 1	Configure cvlan-svlan mapping registration table for the bridge.
(config-cvlan-registration)#cvlan 2 svlan 200	Map CVLAN to SVLAN
(config-cvlan-registration)#exit	Exit the config-cvlan-registration mode

## MLAG Configuration

(config)#interface mlag1	Enter the interface mode
(config-if)#switchport	Make the interface as switch port
(config-if)#bridge-group 1 spanning-tree disable	Associate the interface to bridge and disable the spanning tree.
(config-if)# switchport mode customer-edge hybrid	Configure the mode as customer-edge hybrid
(config-if)# switchport customer-edge hybrid allowed vlan all	Configure allowed VLAN all on the interface
(config-if)#switchport customer-edge vlan registration map1	Map the cvlan registration table into the MLAG interface
(config-if)#mode active-standby	Configuring MLAG mode
(config-if)#exit	Exit the interface mode
(config)#interface mlag2	Enter the interface mode
(config-if)#switchport	Make the interface as switch port
(config-if)#bridge-group 1 spanning-tree disable	Associate the interface to bridge and disable the spanning-tree.
(config-if)# switchport mode provider-network	Configure the mode as provider-network
(config-if)# switchport provider-network allowed vlan all	Configure allowed VLAN all on the interface
(config-if)#mode active-standby	Configuring MLAG mode
(config-if)#exit	Exit the interface mode
(config)#interface sa1	Enter the interface mode
(config-if)#switchport	Make the interface as switch port
(config-if)#mlag 1	Map MLAG on SA interface
(config-if)#exit	Exit the interface mode
(config)#interface sa2	Enter the interface mode
(config-if)#switchport	Make the interface as switch port
(config-if)#mlag 2	Map MLAG on SA interface
(config-if)#exit	Exit the interface mode
(config)#interface xe1	Enter the interface mode
(config-if)# static-channel-group 2	Map static channel-group to the interface
(config-if)#exit	Exit the interface mode
(config)#interface xe13	Enter the interface mode
(config-if)# static-channel-group 2	Map static channel-group to the interface
(config-if)#exit	Exit the interface mode
(config)#interface xe9	Enter the interface mode
(config-if)# static-channel-group 1	Map static channel-group to the interface
(config-if)#exit	Exit the interface mode
(config)#interface xe11	Enter the interface mode

(config-if)# static-channel-group 1	Map static channel to the interface
(config-if)#exit	Exit the interface mode
(config)#interface sa5	Enter the interface mode
(config-if)#switchport	Make the interface as switch port
(config-if)#exit	Exit the interface mode
(config)#interface xe3	Enter the interface mode
(config-if)#static-channel-group 5	Map static channel-group to the interface
(config)#interface xe5	Enter the interface mode
(config-if)#static-channel-group 5	Map static channel-group to the interface
(config-if)#exit	Exit the interface mode
(config)#commit	Commit the transaction.
(config)#mcec domain configuration	Enter the MLAG domain configuration mode
(config-mcec-domain)#domain-address 1111.2222.3333	Configure the MLAG domain address
(config-mcec-domain)#domain-system-number 1	Configure MLAG domain system number
(config-mcec-domain)#intra-domain-link sa5	Configure the intra domain link
(config-mcec-domain)#exit	Exit from mcec domain mode.
(config)#commit	Commit the transaction.

## TOR2

#configure terminal	Enter configure mode.
(config)#hostname TOR2	Configuring host name
(config)#bridge 1 protocol provider-rstp edge	Create a PROVIDER-RSTP EDGE bridge
(config)#vlan database	Enter vlan database mode.
(config-vlan)#vlan 2 bridge 1 state enable	Configure VLAN for the bridge
(config-vlan)# vlan 200 type service point- point bridge 1 state enable	Configure SVLAN for the bridge
(config-vlan)#exit	Exit vlan database mode.
(config)#cvlan registration table map1 bridge 1	Configure cvlan-svlan mapping registration table for the bridge
(config-cvlan-registration)#cvlan 2 svlan 200	Map CVLAN to SVLAN
(config-cvlan-registration)#exit	Exit the config-cvlan-registration mode
(config)#interface mlag1	Enter the interface mode
(config-if)#switchport	Make the interface as switch port
(config-if)#bridge-group 1 spanning-tree disable	Associate the interface to bridge and disable the spanning- tree.

## MLAG Configuration

(config-if)# switchport mode customer-edge hybrid	Configure the mode as customer-edge hybrid
(config-if)# switchport customer-edge hybrid allowed vlan all	Configure allowed VLAN all on the interface
(config-if)#switchport customer-edge vlan registration map1	Map the cvlan registration table into the MLAG interface
(config-if)#mode active-standby	Configuring MLAG mode
(config-if)#exit	Exit the interface mode
(config)#interface mlag2	Enter the interface mode
(config-if)#switchport	Make the interface as switch port
(config-if)#bridge-group 1 spanning-tree disable	Associate the interface to bridge and disable the spanning-tree.
(config-if)# switchport mode provider-network	Configure the mode as provider-network
(config-if)# switchport provider-network allowed vlan all	Configure allowed VLAN all on the interface
(config-if)#mode active-standby	Configuring MLAG mode
(config-if)#exit	Exit the interface mode
(config)#interface sa1	Enter the interface mode
(config-if)#switchport	Make the interface as switch port
(config-if)#mlag 1	Map MLAG on SA interface
(config-if)#exit	Exit the interface mode
(config)#interface sa2	Enter the interface mode
(config-if)#switchport	Make the interface as switch port
(config-if)#mlag 2	Map MLAG on SA interface
(config-if)#exit	Exit the interface mode
(config)#interface xe11	Enter the interface mode
(config-if)# static-channel-group 2	Map static channel to the interface
(config-if)#exit	Exit the interface mode
(config)#interface xe38	Enter the interface mode
(config-if)# static-channel-group 2	Map static channel to the interface
(config-if)#exit	Exit the interface mode
(config)#interface xe2	Enter the interface mode
(config-if)# static-channel-group 1	Create static channel group
(config-if)#exit	Exit the interface mode
(config)#interface xe22	Enter the interface mode
(config-if)# static-channel-group 1	Create static channel group
(config-if)#exit	Exit the interface mode
(config)#interface sa5	Enter the interface mode
(config-if)#switchport	Make the interface as switch port

(config-if)#exit	Exit the interface mode
(config)#interface xe3	Enter the interface mode
(config-if)#static-channel-group 5	Map static channel-group to the interface
(config)#interface xe5	Enter the interface mode
(config-if)#static-channel-group 5	Map static channel-group to the interface
(config-if)#exit	Exit the interface mode
(config)#commit	Commit the transaction.
(config)#mcec domain configuration	Enter the MLAG domain configuration mode
(config-mcec-domain)#domain-address 1111.2222.3333	Configure the MLAG domain address
(config-mcec-domain)#domain-system-number 2	Configure MLAG domain system number
(config-mcec-domain)#intra-domain-link sa5	Configure the intera domain link
(config-if)#exit	Exit the interface mode
(config)#commit	Commit the transaction.

## LEAF

#configure terminal	Enter configure mode.
(config)#hostname LEAF	Configuring host name
(config)#bridge 1 protocol provider-rstp edge	Create a PROVIDER-RSTP EDGE bridge
(config)#vlan database	Enter vlan database mode.
(config-vlan)#vlan 2 bridge 1 state enable	Configure VLAN for the bridge
(config-vlan)# vlan 200 type service point- point bridge 1 state enable	Configure SVLAN for the bridge
(config-vlan)#exit	Exit vlan database mode.
(config)#cvlan registration table map1 bridge 1	Configure cvlan-svlan mapping registration table for the bridge
(config-cvlan-registration)#cvlan 2 svlan 200	Map CVLAN to SVLAN
(config-cvlan-registration)#exit	Exit the config-cvlan-registration mode
(config)#interface sa2	Enter the interface mode
(config-if)#switchport	Make the interface a switch port
(config-if)# bridge-group 1 spanning-tree disable	Disable the spanning-tree for the interface
(config-if)#switchport mode provider- network	Configure the mode as provider-network
(config-if)#)# switchport provider-network allowed vlan all	Configure allowed VLAN all on the interface
(config-if)#exit	Exit the interface mode

## MLAG Configuration

(config)#interface xe1	Enter the interface mode
(config-if)# static-channel-group 2	Map the interface to the static channel-group
(config-if)#exit	Exit the interface mode
(config)#interface xe13	Enter the interface mode
(config-if)# static-channel-group 2	Create static channel group
(config-if)#exit	Exit the interface mode
(config)#interface xe11	Enter the interface mode
(config-if)# static-channel-group 2	Map the interface to the static channel-group
(config-if)#exit	Exit the interface mode
(config)#interface xe38	Enter the interface mode
(config-if)# static-channel-group 2	Create static channel group
(config-if)#exit	Exit the interface mode
(config)#interface xe47	Enter the interface mode
(config-if)#switchport	Make the interface as switch port
(config-if)# bridge-group 1 spanning-tree disable	Disable the spanning-tree for the interface
(config-if)# switchport mode customer-edge hybrid	Configure the mode as customer-edge hybrid
(config-if)# switchport customer-edge hybrid allowed vlan all	Configure allowed VLAN all on the interface
(config-if)#switchport customer-edge vlan registration map1	Map the cvlan registration table into the MLAG interface
(config-if)#exit	Exit the interface mode
(config)#commit	Commit the transaction.

## Validation

```
TOR1#show mlag 1 detail
```

```
MLAG-1
```

```
  Mapped Aggregator       : sa1
  Admin Key               : 16385
  Oper Key                : 16385
  Physical properties Digest : d a6 26 2d fa 9a 5c 7b e6 15 79 c2 d5 9c 57 cc

  Neigh Admin Key        : 32769
  Neigh Physical Digest  : d a6 26 2d fa 9a 5c 7b e6 15 79 c2 d5 9c 57 cc
  Info RCV State         : Current
  Info Periodic Time State : Standby
  Total Bandwidth        : 40g
  Mlag Sync              : IN_SYNC
  Mode                   : Active-Standby
  Current Mlag State     : Active
```

---

TOR1#

TOR1#show mlag domain summary

-----  
Domain Configuration  
-----

Domain System Number : 1  
Domain Address : 1111.2222.3333  
Domain Priority : 32768  
Intra Domain Interface : sa5  
Domain Adjacency : UP

-----  
MLAG Configuration  
-----

MLAG-1

Mapped Aggregator : sa1  
Physical properties Digest : d a6 26 2d fa 9a 5c 7b e6 15 79 c2 d5 9c 57 cc  
Total Bandwidth : 40g  
Mlag Sync : IN\_SYNC  
Mode : Active-Standby  
Current Mlag State : Active

MLAG-2

Mapped Aggregator : sa2  
Physical properties Digest : ae 56 a1 c5 b9 dc 46 a4 5d 97 dc 79 9c 6f a5 c8  
  
Total Bandwidth : 40g  
Mlag Sync : IN\_SYNC  
Mode : Active-Standby  
Current Mlag State : Active

TOR1#

TOR1#show mlag domain detail

-----  
Domain Configuration  
-----

Domain System Number : 1  
Domain Address : 1111.2222.3333

---

## MLAG Configuration

---

Domain Priority : 32768  
Intra Domain Interface : sa5  
  
Hello RCV State : Current  
Hello Periodic Timer State : Slow Periodic  
Domain Sync : IN\_SYNC  
Neigh Domain Sync : IN\_SYNC  
Domain Adjacency : UP

-----  
MLAG Configuration  
-----

### MLAG-1

Mapped Aggregator : sa1  
Admin Key : 16385  
Oper Key : 16385  
Physical properties Digest : d a6 26 2d fa 9a 5c 7b e6 15 79 c2 d5 9c 57 cc  
  
Neigh Admin Key : 32769  
Neigh Physical Digest : d a6 26 2d fa 9a 5c 7b e6 15 79 c2 d5 9c 57 cc  
Info RCV State : Current  
Info Periodic Time State : Standby  
Total Bandwidth : 40g  
Mlag Sync : IN\_SYNC  
Mode : Active-Standby  
Current Mlag State : Active

### MLAG-2

Mapped Aggregator : sa2  
Admin Key : 16386  
Oper Key : 16386  
Physical properties Digest : ae 56 a1 c5 b9 dc 46 a4 5d 97 dc 79 9c 6f a5 c8  
  
Neigh Admin Key : 32770  
Neigh Physical Digest : ae 56 a1 c5 b9 dc 46 a4 5d 97 dc 79 9c 6f a5 c8  
  
Info RCV State : Current  
Info Periodic Time State : Standby  
Total Bandwidth : 40g  
Mlag Sync : IN\_SYNC  
Mode : Active-Standby  
Current Mlag State : Active

TOR1#



## ARP ACL Configuration

### Topology

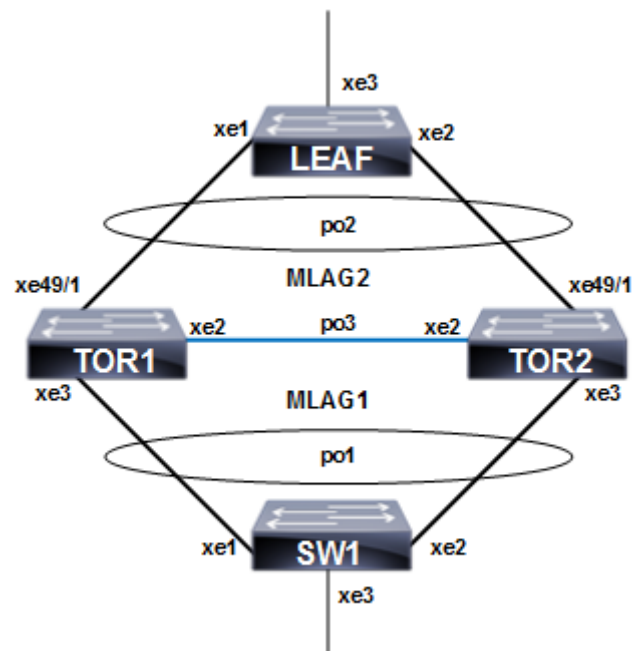

Figure 8-20: ARP ACL configuration with MC LAG

### TOR1

TOR1(config)#bridge 1 protocol provider-rstp edge	Create provider rstp bridge
TOR1(config)#vlan database	Enter vlan database mode.
TOR1(config-vlan)#vlan 2-3990 type customer bridge 1 state enable	Enable customer vlan for bridge
TOR1(config-vlan)#vlan 2-3990 type service point-point bridge 1 state enable	Enable service vlan for bridge
TOR1(config-vlan)#exit	Exit vlan database mode.
TOR1(config)#cvlan registration table map1 bridge 1	Create registration table
TOR1(config-cvlan-registration)#cvlan 2-3990 svlan 3990	Map cvlan to svlan
TOR1(config-cvlan-registration)#exit	Exit the cvlan registration table mode
TOR1(config)#interface mlag1	Enter mlag interface
TOR1(config-if)#switchport	Configure interface as switchport

## MLAG Configuration

TOR1(config-if)#bridge-group 1 spanning-tree disable	Associate the interface to bridge and disable the spanning-tree.
TOR1(config-if)# switchport mode customer-edge hybrid	Configure the mode as customer-edge hybrid
TOR1(config-if)# switchport customer-edge hybrid allowed vlan all	Configure allowed VLAN all on the interface
TOR1(config-if)#switchport customer-edge vlan registration map1	Map the cvlan registration table into the MLAG interface
TOR1(config-if)#exit	Exit interface mode.
TOR1(config)#interface mlag2	Enter mlag interface mode.
TOR1(config-if)#switchport	Configure interface as switchport
TOR1(config-if)#bridge-group 1 spanning-tree disable	Associate the interface to bridge and disable the spanning-tree.
TOR1(config-if)#switchport mode provider-network	Set the switching characteristics of this interface to provider network
TOR1(config-if)#switchport provider-network allowed vlan all	Set the switching characteristics of this interface to provider network and allow all vlan
TOR1(config-if)#exit	Exit the interface mode
TOR1(config)#interface po1	Enter dynamic lag interface
TOR1(config-if)#switchport	Configure interface as switchport
TOR1(config-if)#mlag 1	Enable mlag group number
TOR1(config-if)#exit	Exit the interface mode
TOR1(config-if)#interface po2	Enter dynamic lag interface
TOR1(config-if)#switchport	Configure interface as switchport
TOR1(config-if)#mlag 2	Enable mlag group number
TOR1(config-if)#exit	Exit the interface mode
TOR1(config)#interface po3	Enter dynamic lag interface
TOR1(config-if)#switchport	Configure interface as switchport
TOR1(config-if)#exit	Exit the interface mode
TOR1(config)#interface xe2	Enter interface mode
TOR1(config-if)#channel-group 3 mode active	Make part of channel group 3
TOR1(config-if)#exit	Exit the interface mode
TOR1(config)#interface xe3	Enter interface mode
TOR1(config-if)#channel-group 1 mode active	Add this interface to channel group 1 and enable link aggregation so that it can be selected for aggregation by the local system
TOR1(config-if)#exit	Exit the interface mode
TOR1(config-if)#interface xe49/1	Enter interface mode
TOR1(config-if)#channel-group 2 mode active	Enable channel-group 2
TOR1(config-if)#exit	Exit the interface mode
TOR1(config)#commit	Commit the transaction.

TOR1(config)#mcec domain configuration	Enter MCEC mode
TOR1(config-mcec-domain)#domain-address 2222.3333.4444	Domain address for the mlag domain
TOR1(config-mcec-domain)#domain-system-number 1	Number to identify the node in a domain
TOR1(config-mcec-domain)#intra-domain-link po3	Intra domain line between mlag domain
TOR1(config-mcec-domain)#exit	Exit mcec domain mode.
TOR1(config)#commit	Commit the transaction.
TOR1(config)#hardware-profile filter ingress-arp enable	Enable globally hardware profile for arp
TOR1(config)#arp access-list cep	Create access list with name as cep
TOR1(config-arp-acl)# 30 permit request ip any mac host 0000.2A6C.668D vlan 3990 inner- vlan 2	Create permit rule for particular arp request
TOR1(config-arp-acl)# 40 permit response ip any any mac host 0000.2A6C.668D host 0000.2A6C.7202 vlan 3990 inner-vlan 2	Create permit rule for particular arp response
TOR1(config-arp-acl)#exit	Exit ARP ACL mode.
TOR1(config)#arp access-list pnp	Create access list with name as pnp
TOR1(config-arp-acl)#20 permit request ip any mac host 0000.2A6C.7202 vlan 3990 inner- vlan 2	Create permit rule for particular arp request
TOR1(config-arp-acl)#30 permit response ip any any mac host 0000.2A6C.7202 host 0000.2A6C.668D vlan 3990 inner-vlan 2	Create permit rule for particular arp response
TOR1(config-arp-acl)#exit	Exit ARP ACL mode.
TOR1(config)#interface mlag1	Enter mlag1 interface
TOR1(config-if)#arp access-group cep in	Attach rule with access-group cep
TOR1(config-if)#interface mlag2	Enter mlag2 interface
TOR1(config-if)#arp access-group pnp in	Attach rule with access-group pnp
TOR1(config-if)#exit	Exit interface mode.
TOR1(config)#commit	Commit the transaction.

**TOR2**

TOR2(config)#bridge 1 protocol provider-rstp edge	Create provider rstp bridge
TOR2(config)#vlan database	Enter vlan database mode.

## MLAG Configuration

TOR2(config-vlan)#vlan 2-3990 type customer bridge 1 state enable	Enable customer vlan for bridge
TOR2(config-vlan)#vlan 2-3990 type service point-point bridge 1 state enable	Enable service vlan for bridge
TOR2(config-vlan)#exit	Exit vlan database mode.
TOR2(config)#cvlan registration table map1 bridge 1	Create registration table
TOR2(config-cvlan-registration)#cvlan 2- 3990 svlan 3990	Map cvlan to svlan
TOR2(config-cvlan-registration)#exit	Exit the cvlan registration table mode
TOR2(config)#interface mlag1	Enter mlag interface mode.
TOR2(config-if)#switchport	Configure interface as a switch.
TOR2(config-if)#bridge-group 1 spanning- tree disable	Associate the interface with bridge group 1and disabling spanning-tree
TOR2(config-if)#switchport mode customer- edge hybrid	Set the switching characteristics of this interface to customer- edge hybrid
TOR2(config-if)#switchport customer-edge hybrid allowed vlan all	Set the switching characteristics of this interface to customer- edge hybrid and allow vlan all
TOR2(config-if)#switchport customer-edge vlan registration map1	Configure the registration table mapping on mlag interface
TOR2(config-if)#exit	Exit the interface mode
TOR2(config)#interface mlag2	Enter mlag interface
TOR2(config-if)#switchport	Configure interface as switchport
TOR2(config-if)#bridge-group 1	Associate the interface with bridge group 1
TOR2(config-if)#switchport mode provider- network	Set the switching characteristics of this interface to provider network
TOR2(config-if)#switchport provider-network allowed vlan all	Set the switching characteristics of this interface to provider network and allow all vlan
TOR2(config-if)#exit	Exit the interface mode
TOR2(config)#interface po1	Enter dynamic lag interface
TOR2(config-if)#switchport	Configure interface as switchport
TOR2(config-if)#mlag 1	Enable mlag group number
TOR2(config-if)#exit	Exit the interface mode
TOR2(config)#interface po2	Enter dynamic lag interface
TOR2(config-if)#switchport	Configure interface as switchport
TOR2(config-if)#mlag 2	Enable mlag group number
TOR2(config-if)#exit	Exit the interface mode
TOR2(config)#interface po3	Enter dynamic lag interface
TOR2(config-if)#switchport	Configure interface as switchport
TOR2(config-if)#exit	Exit the interface mode
TOR2(config)#interface xe2	Enter interface mode

TOR2 (config-if) #channel-group 3 mode active	Make part of channel group 3
TOR2 (config-if) #interface xe3	Enter interface mode
TOR2 (config-if) #channel-group 1 mode active	Add this interface to channel group 1 and enable link aggregation so that it can be selected for aggregation by the local system
TOR2 (config-if) #exit	Exit the interface mode
TOR2 (config) #Interface xe49/1	Enter interface mode
TOR2 (config-if) #channel-group 2 mode active	Enable channel-group 2
TOR2 (config-if) #exit	Exit interface mode.
TOR2 (config) #commit	Commit the transaction.
TOR2 (config) #mcec domain configuration	Configure mcec domain information
TOR2 (config-mcec-domain) #domain-address 2222.3333.4444	Domain address for the mlag domain
TOR2 (config-mcec-domain) #domain-system-number 2	Number to identify the node in a domain
TOR2 (config-mcec-domain) #intra-domain-link po3	Intra domain line between mlag domain
TOR2 (config-mcec-domain) #exit	Exit mcec domain mode.
TOR2 (config) #commit	Commit the transaction.
TOR2 (config) #hardware-profile filter ingress-arp enable	Enable globally hardware profile for arp
TOR2 (config) #arp access-list cep	Create access list with name as cep
TOR2 (config-arp-acl) # 30 permit request ip any mac host 0000.2A6C.668D vlan 3990 inner-vlan 2	Create permit rule for particular arp request
TOR2 (config-arp-acl) # 40 permit response ip any any mac host 0000.2A6C.668D host 0000.2A6C.7202 vlan 3990 inner-vlan 2	Create permit rule for particular arp response
TOR2 (config-arp-acl) #exit	Exit ARP ACL mode.
TOR2 (config) #arp access-list pnp	Create access list with name as pnp
TOR2 (config-arp-acl) #20 permit request ip any mac host 0000.2A6C.7202 vlan 3990 inner-vlan 2	Create permit rule for particular arp request
TOR2 (config-arp-acl) #30 permit response ip any any mac host 0000.2A6C.7202 host 0000.2A6C.668D vlan 3990 inner-vlan 2	Create permit rule for particular arp response
TOR2 (config-arp-acl) #exit	Exit ARP ACL mode.
TOR2 (config-if) #interface mlag1	Enter mlag1 interface
TOR2 (config-if) #arp access-group cep in	Attach rule with access-group cep

## MLAG Configuration

TOR2(config-if)#interface mlag2	Enter mlag2 interface
TOR2(config-if)#arp access-group pnp in	Attach rule with access-group pnp
TOR2(config-if)#exit	Exit interface mode.
TOR2(config)#commit	Commit the transaction.

## SW1

SW1(config)#bridge 1 protocol rstp vlan-bridge	Configure the rstp vlan bridge
SW1(config)#vlan database	Enter vlan database mode.
SW1(config-vlan)#vlan 2-3990 type customer bridge 1 state enable	Enable customer vlan for bridge
SW1(config-vlan)#exit	Exit vlan database mode.
SW1(config)#interface po1	Enter dynamic lag interface
SW1(config-if)#switchport	Configure interface as switchport
SW1(config-if)#bridge-group 1 spanning-tree disable	Associate the interface with bridge group 1 and disabling spanning-tree
SW1(config-if)#switchport mode hybrid	Set the switching characteristics of this interface hybrid
SW1(config-if)#switchport hybrid allowed vlan all	Set the switching characteristics of this interface hybrid and allowing all vlan
SW1(config-if)#exit	Exit the interface mode
SW1(config)#interface xe1	Enter interface mode
SW1(config-if)#channel-group 1 mode active	Add this interface to channel group 1 and enable link aggregation so that it can be selected for aggregation by the local system.
SW1(config-if)#exit	Exit the interface mode
SW1(config)#interface xe2	Enter interface mode
SW1(config-if)#channel-group 1 mode active	Add this interface to channel group 1 and enable link aggregation so that it can be selected for aggregation by the local system.
SW1(config-if)#exit	Exit the interface mode
SW1(config)#interface xe3	Enter interface mode
SW1(config-if)#switchport	Configure interface as switchport
SW1(config-if)#bridge-group 1 spanning-tree disable	Associate the interface with bridge group 1 and disabling spanning-tree
SW1(config-if)#switchport mode hybrid	Set the switching characteristics of this interface hybrid
SW1(config-if)#switchport hybrid allowed vlan all	Set the switching characteristics of this interface hybrid and allowing all vlan
SW1(config-if)#exit	Exit the interface mode
SW1(config)#commit	Commit the transaction.

**LEAF**

Leaf(config)#bridge 1 protocol provider-rstp edge	Configure the rstp vlan bridge
Leaf(config)#vlan database	Enter vlan database
Leaf(config-vlan)#vlan 2-3990 type customer bridge 1 state enable	Enable customer vlan for bridge
Leaf(config)#vlan 2-3990 type service point-point bridge 1 state enable	Enable service vlan for bridge
Leaf(config-vlan)#exit	Exit vlan database mode.
Leaf(config)#cvlan registration table map1 bridge 1	Create registration table
Leaf(config-cvlan-registration)#cvlan 2-3990 svlan 3990	Map cvlan to svlan
Leaf(config-cvlan-registration)#exit	Exit the cvlan registration table mode
Leaf(config)#interface po2	Enter interface mode
Leaf(config-if)#switchport	Configure interface as switchport
Leaf(config-if)#bridge-group 1 spanning-tree disable	Associate the interface with bridge group 1 and disabling spanning-tree
Leaf(config-if)#switchport mode provider-network	Set the switching characteristics of this interface provider network
Leaf(config-if)#switchport provider-network allowed vlan all	Set the switching characteristics of this interface provider and allowing all vlan
Leaf(config-if)#exit	Exit the interface mode
Leaf(config)#interface xe1	Enter interface mode
Leaf(config-if)#channel-group 2 mode active	Add this interface to channel group 2 and enable link aggregation so that it can be selected for aggregation by the local system.
Leaf(config-if)#exit	Exit the interface mode
Leaf(config)#interface xe2	Enter interface mode
Leaf(config-if)#channel-group 2 mode active	Add this interface to channel group 2 and enable link aggregation so that it can be selected for aggregation by the local system.
Leaf(config-if)#exit	Exit the interface mode
Leaf(config)#Interface xe3	Enter interface mode
Leaf(config-if)#switchport	Configure interface as switchport
Leaf(config-if)#bridge-group 1 spanning-tree disable	Associate the interface with bridge group 1 and disabling spanning-tree
Leaf(config-if)#switchport mode customer-edge hybrid	Set the switching characteristics of this interface to customer-edge hybrid
Leaf(config-if)#switchport customer-edge hybrid allowed vlan all	Set the switching characteristics of this interface to customer-edge hybrid and allow vlan all

Leaf(config-if)#switchport customer-edge vlan registration map1	Configure the registration table mapping on mlag interface
Leaf(config-if)#exit	Exit the interface mode
Leaf(config)#commit	Commit the transaction.

---

## Validation

```
TOR1#show access-lists
ARP access list cep
    30 permit request ip any mac host 0000.2A6C.668D vlan 3990 inner-vlan 2
    40 permit response ip any any mac host 0000.2A6C.668D host 0000.2A6C.7202 vlan
3990 inner-vlan 2
    default deny-all
ARP access list pnp
    20 permit request ip any mac host 0000.2A6C.7202 vlan 3990 inner-vlan 2 [match=1]
    30 permit response ip any any mac host 0000.2A6C.7202 host 0000.2A6C.668D vlan
3990 inner-vlan 2 [match=1]
    default deny-all log

TOR2#show access-lists
ARP access list cep
    30 permit request ip any mac host 0000.2A6C.668D vlan 3990 inner-vlan 2 [match=1]
    40 permit response ip any any mac host 0000.2A6C.668D host 0000.2A6C.7202 vlan
3990 inner-vlan 2 [match=1]
    default deny-all log
ARP access list pnp
    20 permit request ip any mac host 0000.2A6C.7202 vlan 3990 inner-vlan 2
    30 permit response ip any any mac host 0000.2A6C.7202 host 0000.2A6C.668D vlan
3990 inner-vlan 2
    default deny-all
```

---

## Disabling STP for MLAG

The command `no bridge 1 provider-rstp enable bridge-forward` is used to disable the spanning tree globally.

---

## Enabling Provider RSTP

OcNOS#configure terminal	Enter Configure mode.
OcNOS(config)# bridge 1 protocol provider-rstp edge	Configure Provider-rstp edge bridge.
OcNOS(config)# interface xe13/2	Configure interface xe13/2\
OcNOS(config-if)# switchport	Configure the interface as switchport
OcNOS(config-if)# bridge-group 1	Assign the above created bridge to this port.
OcNOS(config-vrf)#exit	Exit from interface mode to config mode
OcNOS(config)# interface po1	Configure interface po1



OcNOS(config-if)# switchport	Configure the interface as switchport
OcNOS(config-if)# bridge-group 1	Assign the above created bridge to this port.
OcNOS(config-vrf)#exit	Exit from interface mode to config mode
OcNOS(config)# interface mlag2	Configure interface mlag1
OcNOS(config-if)# switchport	Configure the interface as switchport
OcNOS(config-if)# bridge-group 1 spanning-tree disable	Assign the above created bridge to this port and disable the spanning tree.
OcNOS(config-vrf)#exit	Exit from interface mode to config mode
OcNOS(config)#commit	Commit the transaction.

## Validation

```
OcNOS#show spanning-tree
% 1: Bridge up - Spanning Tree Enabled - topology change detected
% 1: Root Path Cost 0 - Root Port 0 - Bridge Priority 32768
% 1: Forward Delay 15 - Hello Time 2 - Max Age 20 - Transmit Hold Count 6
% 1: Root Id 8000ecf4bbfc6928
% 1: Bridge Id 8000ecf4bbfc6928
% 1: last topology change Tue Jul 30 06:47:37 2019
% 1: 2 topology change(s) - last topology change Tue Jul 30 06:47:37 2019

% 1: portfast bpdu-filter disabled
% 1: portfast bpdu-guard disabled
% xe13/2: Port Number 942 - Ifindex 5038 - Port Id 0x83ae - Role Designated - State Forwarding
% xe13/2: Designated Path Cost 0
% xe13/2: Configured Path Cost 2000 - Add type Explicit ref count 1
% xe13/2: Designated Port Id 0x83ae - Priority 128 -
% xe13/2: Root 8000ecf4bbfc6928
% xe13/2: Designated Bridge 8000ecf4bbfc6928
% xe13/2: Message Age 0 - Max Age 20
% xe13/2: Hello Time 2 - Forward Delay 15
% xe13/2: Forward Timer 0 - Msg Age Timer 0 - Hello Timer 0 - topo change timer 0
% xe13/2: forward-transitions 3
% xe13/2: Version Rapid Spanning Tree Protocol - Receive None - Send RSTP
% xe13/2: No portfast configured - Current portfast off
% xe13/2: bpdu-guard default - Current bpdu-guard off
% xe13/2: bpdu-filter default - Current bpdu-filter off
% xe13/2: no root guard configured - Current root guard off
% xe13/2: Configured Link Type point-to-point - Current point-to-point
% xe13/2: No auto-edge configured - Current port Auto Edge off
%
% po1: Port Number 1697 - Ifindex 100001 - Port Id 0x86a1 - Role Designated - State Forwarding
% po1: Designated Path Cost 0
% po1: Configured Path Cost 2000 - Add type Explicit ref count 1
% po1: Designated Port Id 0x86a1 - Priority 128 -
% po1: Root 8000ecf4bbfc6928
% po1: Designated Bridge 8000ecf4bbfc6928
```

## MLAG Configuration

---

```
% pol: Message Age 0 - Max Age 20
% pol: Hello Time 2 - Forward Delay 15
% pol: Forward Timer 0 - Msg Age Timer 0 - Hello Timer 0 - topo change timer 0
% pol: forward-transitions 1
% pol: Version Rapid Spanning Tree Protocol - Receive None - Send RSTP
% pol: No portfast configured - Current portfast off
% pol: bpdu-guard default - Current bpdu-guard off
% pol: bpdu-filter default - Current bpdu-filter off
% pol: no root guard configured - Current root guard off
% pol: Configured Link Type point-to-point - Current point-to-point
% pol: No auto-edge configured - Current port Auto Edge off
%
% mlag2: Port Number 2690 - Ifindex 400002 - Port Id 0x8a82 - Role Disabled - State
Forwarding
% mlag2: Designated Path Cost 0
% mlag2: Configured Path Cost 20000000 - Add type Explicit ref count 1
% mlag2: Designated Port Id 0x0 - Priority 128 -
% mlag2: Message Age 0 - Max Age 0
% mlag2: Hello Time 0 - Forward Delay 0
% mlag2: Forward Timer 0 - Msg Age Timer 0 - Hello Timer 0 - topo change timer 0
% mlag2: forward-transitions 1
% mlag2: Version Rapid Spanning Tree Protocol - Receive None - Send RSTP
% mlag2: No portfast configured - Current portfast off
% mlag2: bpdu-guard default - Current bpdu-guard off
% mlag2: bpdu-filter default - Current bpdu-filter off
% mlag2: no root guard configured - Current root guard off
% mlag2: Configured Link Type point-to-point - Current point-to-point
% mlag2: No auto-edge configured - Current port Auto Edge off
%
```

---

## Disabling RSTP Globally

OcNOS#configure terminal	Enter Configure mode.
OcNOS(config)# no bridge 1 rapid-spanning-tree enable bridge-forward	Disable spanning tree globally for Provider-RSTP and keeping the ports in Forwarding state.
OcNOS(config)# interface mlag1	Configure interface mlag1
OcNOS(config-if)# switchport	Configure the interface as switchport
OcNOS(config-if)# bridge-group 1	Assign the above created bridge to this port.
OcNOS(config-vrf)#exit	Exit from interface mode to config mode
OcNOS(config)#commit	Commit the transaction.

---

## Validation

```
OcNOS#sh run int mlag2-
!
interface mlag2
 switchport
 bridge-group 1 spanning-tree disable
 switchport mode provider-network
```

```
!  
OcNOS#sh run int mlag1  
!  
interface mlag1  
  switchport  
  bridge-group 1  
  switchport mode provider-network  
!  
OcNOS#  
OcNOS#sh spanning-tree  
% 1: Bridge up - Spanning Tree Disabled - topology change detected  
% 1: Root Path Cost 0 - Root Port 0 - Bridge Priority 32768  
% 1: Forward Delay 15 - Hello Time 2 - Max Age 20 - Transmit Hold Count 6  
% 1: Root Id 8000000000000000  
% 1: Bridge Id 8000000000000000  
% 1: 2 topology change(s) - last topology change Tue Jul 30 06:47:37 2019  
  
% 1: portfast bpdu-filter disabled  
% 1: portfast bpdu-guard disabled  
% xe13/2: Port Number 942 - Ifindex 5038 - Port Id 0x83ae - Role Disabled - State  
Forwarding  
% xe13/2: Designated Path Cost 0  
% xe13/2: Configured Path Cost 2000 - Add type Explicit ref count 1  
% xe13/2: Designated Port Id 0x83ae - Priority 128 -  
% xe13/2: Message Age 0 - Max Age 20  
% xe13/2: Hello Time 2 - Forward Delay 15  
% xe13/2: Forward Timer 0 - Msg Age Timer 0 - Hello Timer 0 - topo change timer 0  
% xe13/2: forward-transitions 4  
% xe13/2: Version Rapid Spanning Tree Protocol - Receive None - Send RSTP  
% xe13/2: No portfast configured - Current portfast off  
% xe13/2: bpdu-guard default - Current bpdu-guard off  
% xe13/2: bpdu-filter default - Current bpdu-filter off  
% xe13/2: no root guard configured - Current root guard off  
% xe13/2: Configured Link Type point-to-point - Current point-to-point  
% xe13/2: No auto-edge configured - Current port Auto Edge off  
%  
% pol: Port Number 1697 - Ifindex 100001 - Port Id 0x86a1 - Role Disabled - State  
Forwarding  
% pol: Designated Path Cost 0  
% pol: Configured Path Cost 2000 - Add type Explicit ref count 1  
% pol: Designated Port Id 0x86a1 - Priority 128 -  
% pol: Message Age 0 - Max Age 20  
% pol: Hello Time 2 - Forward Delay 15  
% pol: Forward Timer 0 - Msg Age Timer 0 - Hello Timer 0 - topo change timer 0  
% pol: forward-transitions 2  
% pol: Version Rapid Spanning Tree Protocol - Receive None - Send RSTP  
% pol: No portfast configured - Current portfast off  
% pol: bpdu-guard default - Current bpdu-guard off  
% pol: bpdu-filter default - Current bpdu-filter off  
% pol: no root guard configured - Current root guard off  
% pol: Configured Link Type point-to-point - Current point-to-point
```

## MLAG Configuration

---

```
% pol: No auto-edge configured - Current port Auto Edge off
%
% mlag1: Port Number 2689 - Ifindex 400001 - Port Id 0x8a81 - Role Disabled - State
Forwarding
% mlag1: Designated Path Cost 0
% mlag1: Configured Path Cost 20000000 - Add type Explicit ref count 1
% mlag1: Designated Port Id 0x0 - Priority 128 -
% mlag1: Message Age 0 - Max Age 0
% mlag1: Hello Time 0 - Forward Delay 0
% mlag1: Forward Timer 0 - Msg Age Timer 0 - Hello Timer 0 - topo change timer 0
% mlag1: forward-transitions 2
% mlag1: Version Rapid Spanning Tree Protocol - Receive None - Send RSTP
% mlag1: No portfast configured - Current portfast off
% mlag1: bpdu-guard default - Current bpdu-guard off
% mlag1: bpdu-filter default - Current bpdu-filter off
% mlag1: no root guard configured - Current root guard off
% mlag1: Configured Link Type point-to-point - Current point-to-point
% mlag1: No auto-edge configured - Current port Auto Edge off
%
% mlag2: Port Number 2690 - Ifindex 400002 - Port Id 0x8a82 - Role Disabled - State
Forwarding
% mlag2: Designated Path Cost 0
% mlag2: Configured Path Cost 20000000 - Add type Explicit ref count 1
% mlag2: Designated Port Id 0x0 - Priority 128 -
% mlag2: Message Age 0 - Max Age 0
% mlag2: Hello Time 0 - Forward Delay 0
% mlag2: Forward Timer 0 - Msg Age Timer 0 - Hello Timer 0 - topo change timer 0
% mlag2: forward-transitions 2
% mlag2: Version Rapid Spanning Tree Protocol - Receive None - Send RSTP
% mlag2: No portfast configured - Current portfast off
% mlag2: bpdu-guard default - Current bpdu-guard off
% mlag2: bpdu-filter default - Current bpdu-filter off
% mlag2: no root guard configured - Current root guard off
% mlag2: Configured Link Type point-to-point - Current point-to-point
% mlag2: No auto-edge configured - Current port Auto Edge off
%
```

---

## Port-isolation for MLAG

The feature is to prohibit communication between Isolated ports across MLAG switches. Protected port can communicate with an unprotected port and vice-versa. The use of protected ports ensures that there is no exchange of unicast, broadcast, or multicast data traffic between ports on the same switch so that one neighbor does not see the traffic generated by another neighbor.

---

## Topology

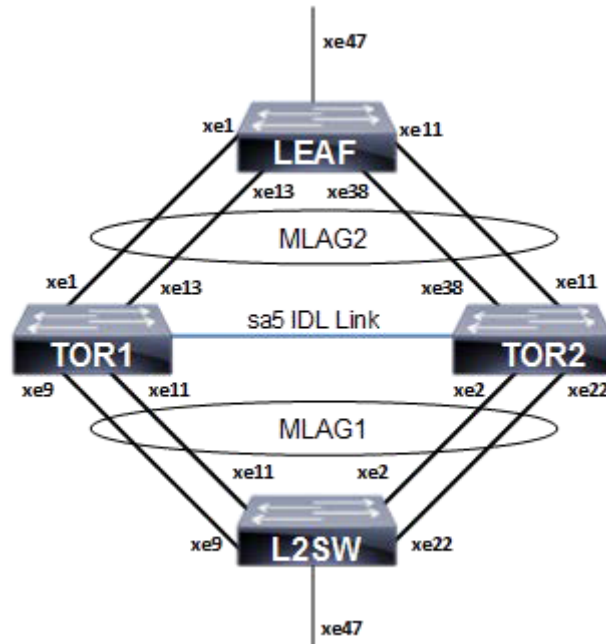

Figure 8-21: Static MLAG Topology

## L2SW

#configure terminal	Enter configure mode.(config)#bridge 1 protocol rstp vlan-bridge
(config)#bridge 1 protocol rstp vlan-bridge	Create RSTP bridge 1.
(config)#vlan database	Enter VLAN database mode.
(config-vlan)#vlan 2 bridge 1 state enable	Create VLAN 2.
(config-vlan)#exit	Exit vlan database mode.
(config)#interface po1	Enter interface mode.
(config-if)#switchport	Configure the interface as Layer 2
(config-if)#bridge-group 1	Associate the interface with bridge group 1.
(config-if)#switchport mode trunk	Set the switching characteristics of this interface to trunk mode.
(config-if)#switchport trunk allowed vlan all	Enable all VLAN identifiers on this interface.
(config-if)#exit	Exit interface mode.
(config)#interface xe2	Enter interface mode.
(config-if)#channel-group 1 mode active	Add this interface to channel group 1 and enable link aggregation so that it can be selected for aggregation by the local system.
(config-if)#exit	Exit interface mode.
(config)#interface xe9	Enter interface mode.
(config-if)#channel-group 1 mode active	Add this interface to channel group 1 and enable link aggregation so that it can be selected for aggregation by the local system.
(config-if)#exit	Exit interface mode.

## MLAG Configuration

<code>(config)#interface xe11</code>	Enter interface mode.
<code>(config-if)#channel-group 1 mode active</code>	Add this interface to channel group 1 and enable link aggregation so that it can be selected for aggregation by the local system.
<code>(config-if)#exit</code>	Exit interface mode.
<code>(config)#interface xe22</code>	Enter interface mode.
<code>(config-if)#channel-group 1 mode active</code>	Add this interface to channel group 1 and enable link aggregation so that it can be selected for aggregation by the local system.
<code>(config-if)#exit</code>	Exit interface mode.
<code>(config)#commit</code>	Commit the transaction.

## TOR1

<code>#configure terminal</code>	Enter configure mode.
<code>(config)#bridge 1 protocol rstp vlan-bridge</code>	Create RSTP bridge 1.
<code>(config)#vlan database</code>	Enter vlan database mode.
<code>(config-vlan)#vlan 2 bridge 1 state enable</code>	Create VLAN 2.
<code>(config-vlan)#exit</code>	Exit vlan database mode.
<code>(config)#hardware-profile filter port-isolation enable</code>	Enable the hardware profile filter globally
<code>(config)#interface mlag1</code>	Enter interface mode.
<code>(config-if)#switchport</code>	Configure the interface as Layer 2
<code>(config-if)#bridge-group 1</code>	Associate the interface with bridge group 1.
<code>(config-if)#switchport mode trunk</code>	Set the switching characteristics of this interface to trunk mode.
<code>(config-if)#switchport trunk allowed vlan all</code>	Enable all VLAN identifiers on this interface.
<code>(config-if)#switchport protected promiscuous</code>	Configure interface as promiscuous port
<code>(config-if)#exit</code>	Exit interface mode.
<code>(config)#interface mlag2</code>	Enter interface mode.
<code>(config-if)#switchport</code>	Configure the interface as Layer 2
<code>(config-if)#bridge-group 1</code>	Associate the interface with bridge group 1.
<code>(config-if)#switchport mode trunk</code>	Set the switching characteristics of this interface to trunk mode.
<code>(config-if)#switchport trunk allowed vlan all</code>	Enable all VLAN identifiers on this interface.
<code>(config-if)#switchport protected isolated</code>	Configure interface as isolated port
<code>(config-if)#exit</code>	Exit interface mode.
<code>(config)#interface po1</code>	Enter interface mode.
<code>(config-if)#switchport</code>	Configure the interface as Layer 2
<code>(config-if)#mlag 1</code>	Enabling Mlag group number
<code>(config-if)#exit</code>	Exit interface mode.
<code>(config)#interface po2</code>	Enter interface mode.

(config-if)#switchport	Configure the interface as Layer 2
(config-if)#mlag 2	enabling Mlag group number
(config-if)#exit	Exit interface mode.
(config)#interface po3	Enter interface mode.
(config-if)#switchport	Configure the interface as Layer 2
(config-if)#exit	Exit interface mode.
(config)#interface xe9	Enter interface mode.
(config-if)#channel-group 1 mode active	Add this interface to channel group 1 and enable link aggregation so that it can be selected for aggregation by the local system.
(config-if)#exit	Exit interface mode.
(config)#interface xel1	Enter interface mode.
(config-if)#channel-group 1 mode active	Add this interface to channel group 1 and enable link aggregation so that it can be selected for aggregation by the local system.
(config-if)#exit	Exit interface mode.
(config)#interface xel	Enter interface mode.
(config-if)#channel-group 2 mode active	Add this interface to channel group 2 and enable link aggregation so that it can be selected for aggregation by the local system.
(config-if)#exit	Exit interface mode.
(config)#interface xel3	Enter interface mode.
(config-if)#channel-group 2 mode active	Add this interface to channel group 2 and enable link aggregation so that it can be selected for aggregation by the local system.
(config-if)#exit	Exit interface mode.
(config)#interface xe49	Enter interface mode.
(config-if)#channel-group 3 mode active	Add this interface to channel group 3 and enable link aggregation so that it can be selected for aggregation by the local system.
(config-if)#exit	Exit interface mode.
(cosnfig)#commit	Commit the transaction.
(config)#mcec domain configuration	Entering MCEC mode
(config-mcec-domain)#domain-address 1111.2222.3333	Domain address for the mlag domain
(config-mcec-domain)# domain-system-number 1	Number to identify the node in a domain
(config-mcec-domain)# intra-domain link po3	Intra domain line between mlag domain
(config-mcec-domain)#idl-higig	Enable the idl-higig on mlag idl.
(config-mcec-domain)#exit	Exit MCEC mode
(config)#commit	Commit the transaction.

## TOR2

#configure terminal	Enter configure mode.
(config)#bridge 1 protocol rstp vlan-bridge	Create RSTP bridge 1.

## MLAG Configuration

<code>(config)#vlan database</code>	Enter vlan database mode.
<code>(config-vlan)#vlan 2 bridge 1 state enable</code>	Create VLAN 2.
<code>(config-vlan)#exit</code>	Exit vlan database mode.
<code>(config)#hardware-profile filter port-isolation enable</code>	Enable the hardware profile filter globally
<code>(config)#interface mlag1</code>	Enter interface mode.
<code>(config-if)#switchport</code>	Configure the interface as Layer 2
<code>(config-if)#bridge-group 1</code>	Associate the interface with bridge group 1.
<code>(config-if)#switchport mode trunk</code>	Set the switching characteristics of this interface to trunk mode.
<code>(config-if)#switchport trunk allowed vlan all</code>	Enable all VLAN identifiers on this interface.
<code>(config-if)#switchport protected promiscuous</code>	Configure interface as promiscuous port
<code>(config-if)#exit</code>	Exit interface mode.
<code>(config)#interface mlag2</code>	Enter interface mode.
<code>(config-if)#switchport</code>	Configure the interface as Layer 2
<code>(config-if)#bridge-group 1</code>	Associate the interface with bridge group 1.
<code>(config-if)#switchport mode trunk</code>	Set the switching characteristics of this interface to trunk mode.
<code>(config-if)#switchport trunk allowed vlan all</code>	Enable all VLAN identifiers on this interface.
<code>(config-if)#switchport protected isolated</code>	Configure interface as isolated port
<code>(config-if)#exit</code>	Exit interface mode.
<code>(config)#interface po1</code>	Enter interface mode.
<code>(config-if)#switchport</code>	Configure the interface as Layer 2
<code>(config-if)#mlag 1</code>	Enabling Mlag group number
<code>(config-if)#exit</code>	Exit interface mode.
<code>(config)#interface po2</code>	Enter interface mode.
<code>(config-if)#switchport</code>	Configure the interface as Layer 2
<code>(config-if)#mlag 2</code>	Enabling Mlag group number
<code>(config-if)#exit</code>	Exit interface mode.
<code>(config)#interface po3</code>	Enter interface mode.
<code>(config-if)#switchport</code>	Configure the interface as Layer 2
<code>(config-if)#exit</code>	Exit interface mode.
<code>(config)#interface xe2</code>	Enter interface mode.
<code>(config-if)#channel-group 1 mode active</code>	Add this interface to channel group 1 and enable link aggregation so that it can be selected for aggregation by the local system.
<code>(config-if)#exit</code>	Exit interface mode.
<code>(config)#interface xe22</code>	Enter interface mode.
<code>(config-if)#channel-group 1 mode active</code>	Add this interface to channel group 1 and enable link aggregation so that it can be selected for aggregation by the local system.
<code>(config-if)#exit</code>	Exit interface mode.



(config)#interface xe11	Enter interface mode.
(config-if)#channel-group 2 mode active	Add this interface to channel group 2 and enable link aggregation so that it can be selected for aggregation by the local system.
(config-if)#exit	Exit interface mode.
(config)#interface xe38	Enter interface mode.
(config-if)#channel-group 2 mode active	Add this interface to channel group 2 and enable link aggregation so that it can be selected for aggregation by the local system.
(config-if)#exit	Exit interface mode.
(config)#interface xe49	Enter interface mode.
(config-if)#channel-group 3 mode active	Add this interface to channel group 3 and enable link aggregation so that it can be selected for aggregation by the local system.
(config-if)#exit	Exit interface mode.
(config)#commit	Commit the transaction.
(config)#mcec domain configuration	Entering MCEC mode
(config-mcec-domain)#domain-address 1111.2222.3333	Domain address for the mlag domain
(config-mcec-domain)# domain-system-number 2	Number to identify the node in a domain
(config-mcec-domain)# intra-domain link po3	Intra domain line between mlag domain
(config-mcec-domain)#idl-higig	Enable the idl-higig on mlag idl.
(config-mcec-domain)#exit	Exit MCEC mode
(config)#commit	Commit the transaction.

## LEAF

#configure terminal	Enter configure mode.
(config)#bridge 1 protocol rstp vlan-bridge	Create RSTP bridge 1.
(config)#vlan database	Enter vlan database mode.
(config-vlan)#vlan 2 bridge 1 state enable	Create VLAN 2.
(config-vlan)#exit	Exit vlan database mode.
(config)#interface po2	Enter interface mode.
(config-if)#switchport	Configure the interface as Layer 2
(config-if)#bridge-group 1	Associate the interface with bridge group 1.
(config-if)#switchport mode trunk	Set the switching characteristics of this interface to trunk mode.
(config-if)#switchport trunk allowed vlan all	Enable all VLAN identifiers on this interface.
(config-if)#exit	Exit interface mode.
(config)#interface xe1	Enter interface mode.
(config-if)#channel-group 2 mode active	Add this interface to channel group 2 and enable link aggregation so that it can be selected for aggregation by the local system.
(config-if)#exit	Exit interface mode.

## MLAG Configuration

(config)#interface xe11	Enter interface mode.
(config-if)#channel-group 2 mode active	Add this interface to channel group 2 and enable link aggregation so that it can be selected for aggregation by the local system.
(config-if)#exit	Exit interface mode.
(config)#interface xe13	Enter interface mode.
(config-if)#channel-group 2 mode active	Add this interface to channel group 2 and enable link aggregation so that it can be selected for aggregation by the local system.
(config-if)#exit	Exit interface mode.
(config)#interface xe38	Enter interface mode.
(config-if)#channel-group 2 mode active	Add this interface to channel group 2 and enable link aggregation so that it can be selected for aggregation by the local system.
(config-if)#exit	Exit interface mode.
(config)#commit	(config)#commit

## Validation

### TOR1

```
#sh mlag domain details
```

#### Domain Configuration

```
Domain System Number      :1
Domain Address             :1111.2222.3333
Domain Priority            :1000
Intra Domain Interface    :po3
  Hello RCV State         :Current
  Hello Periodic Timer State :Fast Periodic
Domain Sync                :IN_SYNC
Neigh Domain Sync         :IN_SYNC
Domain Adjacency          :UP
```

#### MLAG Configuration

```
MLAG-1
Mapped Aggregator        :po1
Admin Key                : 16385
Oper Key                 : 16385
Physical properties Digest : dd 9c f 76 dd b6 5f 2f eb a1 d3 bb 8d 96
fc 82

Neigh Admin Key          : 32769
Neigh Physical Digest   : dd 9c f 76 dd b6 5f 2f eb a1 d3 bb 8d 96
fc 82
Info RCV State           : Current
Info Periodic Time State : Standby
Mlag Sync                : IN_SYNC
Mode                     : Active-Active
```

```
Current Mlag State           : Active

MLAG-2
Mapped Aggregator           : po2
Admin Key                   : 16386
Oper Key                    : 16386
Physical properties Digest   : dd 9c f 76 dd b6 5f 2f eb a1 d3 bb 8d 96 fc
82

Neigh Admin Key             : 32770
Neigh Physical Digest       : dd 9c f 76 dd b6 5f 2f eb a1 d3 bb 8d 96 fc
82
Info RCV State              : Current
Info Periodic Time State    : Standby
Mlag Sync                   : IN_SYNC
Mode                        : Active-Active
Current Mlag State          : Active

#sh etherchannel summary
  Aggregator po1 100001
  Aggregator Type: Layer2
  Admin Key: 16385 - Oper Key 16385
    Link: xe9 (5007) sync: 1 (Mlag-active-link)
    Link: xe11 (5008) sync: 1 (Mlag-active-link)
-----
  Aggregator po2 100002
  Aggregator Type: Layer2
  Admin Key: 16386 - Oper Key 16386
    Link: xe1 (5005) sync: 1 (Mlag-active-link)
    Link: xe13 (5006) sync: 1 (Mlag-active-link)
-----
  Aggregator po3 100003
  Aggregator Type: Layer2
  Admin Key: 0003 - Oper Key 0003
    Link: xe49 (5002) sync: 1

#sh mlag 1 detail
MLAG-1
Mapped Aggregator           :po1
Admin Key                   : 16385
Oper Key                    : 16385
Physical properties Digest   : dd 9c f 76 dd b6 5f 2f eb a1 d3 bb 8d 96
fc 82

Neigh Admin Key             : 32769
Neigh Physical Digest       : dd 9c f 76 dd b6 5f 2f eb a1 d3 bb 8d 96
fc 82
Info RCV State              : Current
Info Periodic Time State    : Standby
Mlag Sync                   : IN_SYNC
Mode                        : Active-Active
Current Mlag State          : Active

#sh mcec statistics

Unknown MCCPDU received on the system           : 0
```

IDP xe49

```
Valid RX Hello PDUs           : 398
Valid TX Hello PDUs           : 417
Valid RX Info PDUs            : 16
Valid TX Info PDUs            : 6
```

```
Valid RX Mac Sync PDUs        : 3
Valid TX Mac Sync PDUs        : 4
```

MLAG 1

```
Valid RX Info PDUs           : 8
Valid TX Info PDUs           : 3
```

MLAG 2

```
Valid RX Info PDUs           : 8
Valid TX Info PDUs           : 3
```

#sh mlag domain summary

Domain Configuration

```
Domain System Number          :1
Domain Address                 :1111.2222.3333
Domain Priority                 :1000
Intra Domain Interface        :xe49
Domain Adjacency               :UP
```

MLAG Configuration

MLAG-1

```
Mapped Aggregator             :po1
Physical properties Digest     : dd 9c f 76 dd b6 5f 2f eb a1 d3 bb 8d 96
fc 82
```

```
Total Bandwidth               : 40g
Mlag Sync                      : IN_SYNC
Mode                           : Active-Active
Current Mlag State             : Active
```

MLAG-2

```
Mapped Aggregator             : po2
Physical properties Digest     : dd 9c f 76 dd b6 5f 2f eb a1 d3 bb 8d 96 fc
82
```

```
Total Bandwidth               : 40g
Mlag Sync                      : IN_SYNC
Mode                           : Active-Active
Current Mlag State             : Active
```

## CHAPTER 9 MSTP Configuration

This chapter contains a complete sample Multiple Spanning Tree Protocol (MSTP) configuration. MSTP allows multiple VLANs to be grouped into one spanning-tree instance. Every MST instance has a spanning-tree that is independent of other spanning-tree instances providing multiple forwarding paths for data traffic.

### Topology

This example gives a simple multi-bridge topology and its configuration.

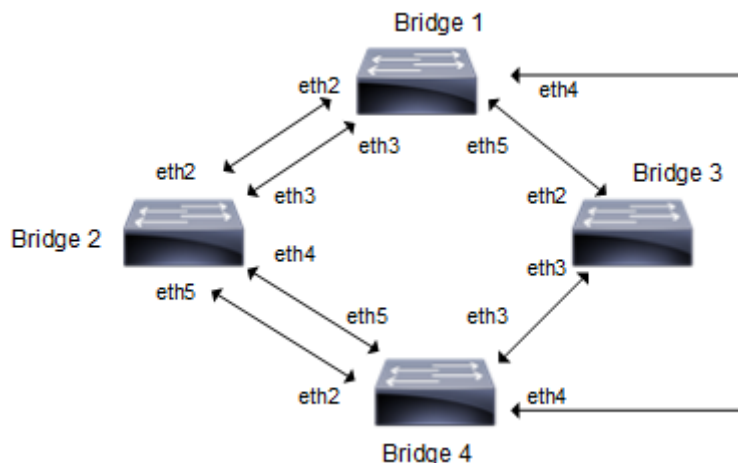

Figure 9-22: MSTP Topology

Note: Run the `switchport` command on each port to change to Layer-2 mode.

## Configuration

### Bridge 1

<code>Bridge1#configure terminal</code>	Enter configure mode.
<code>Bridge1(config)#bridge 1 protocol mstp</code>	Add a bridge (1) to the multiple spanning tree table.
<code>Bridge1(config)#vlan database</code>	Enter the VLAN configuration mode.
<code>Bridge1(config-vlan)#vlan 2 bridge 1 state enable</code>	Enable the state of VLAN 2 on bridge 1. Specifying an enable state allows forwarding of frames over VLAN 2 on bridge 1.
<code>Bridge1(config-vlan)#vlan 3 bridge 1 state enable</code>	Enable the state of VLAN 3 on bridge 1. Specifying an enable state allows forwarding of frames over VLAN 3 on bridge 1.
<code>Bridge1(config-vlan)#vlan 4 bridge 1 state enable</code>	Enable the state of VLAN 4 on bridge 1. Specifying an enable state allows forwarding of frames over VLAN 4 on bridge 1.
<code>Bridge1(config-vlan)#vlan 5 bridge 1 state enable</code>	Enable the state of VLAN 5 on bridge 1. Specifying an enable state allows forwarding of frames over VLAN 5 on bridge 1.
<code>Bridge1(config-vlan)#commit</code>	Commit candidate configuration to be running configuration
<code>Bridge1(config-vlan)#exit</code>	Exit the VLAN configuration mode.
<code>Bridge1(config)#spanning-tree mst configuration</code>	Enter the Multiple Spanning Tree

## MSTP Configuration

<pre>Bridgel(config-mst)#bridge 1 instance 2 vlan 2</pre>	Create an instance of VLAN. The VLANs must be created before being associating with an MST instance (MSTI). If the VLAN range is not specified the MSTI will not be created.
<pre>Bridgel(config-mst)#bridge 1 instance 3 vlan 3</pre>	Create another instance of VLAN. The VLANs must be created before being associating with an MST instance (MSTI). If the VLAN range is not specified the MSTI will not be created.
<pre>Bridgel(config-mst)#bridge 1 instance 4 vlan 4</pre>	same as mention above.
<pre>Bridgel(config-mst)#bridge 1 instance 5 vlan 5</pre>	same as mention above.
<pre>Bridgel(config-mst)#commit</pre>	Commit candidate configuration to be running configuration
<pre>Bridgel(config-mst)#exit</pre>	Exit MST Configuration mode.
<pre>Bridgel(config)#interface eth2</pre>	Enter interface mode for eth2
<pre>Bridgel(config-if)#bridge-group 1</pre>	Associating the interface to bridge-group 1
<pre>Bridgel(config-if)#bridge-group 1 instance 2</pre>	Assigning bridge-group 1 to this instance
<pre>Bridgel(config-if)#bridge-group 1 instance 3</pre>	Assigning bridge-group 1 to this instance
<pre>Bridgel(config-if)#bridge-group 1 instance 4</pre>	Assigning bridge-group 1 to this instance
<pre>Bridgel(config-if)#bridge-group 1 instance 5</pre>	Assigning bridge-group 1 to this instance
<pre>Bridgel(config-if)#commit</pre>	Commit candidate configuration to be running configuration
<pre>Bridgel(config-if)#exit</pre>	Exit interface mode.
<pre>Bridgel(config)#interface eth3</pre>	Enter interface mode for eth3.
<pre>Bridgel(config-if)#bridge-group 1</pre>	Associating the interface to bridge-group 1
<pre>Bridgel(config-if)#bridge-group 1 instance 2</pre>	Assigning bridge-group 1 to this instance
<pre>Bridgel(config-if)#bridge-group 1 instance 3</pre>	Assigning bridge-group 1 to this instance
<pre>Bridgel(config-if)#bridge-group 1 instance 4</pre>	Assigning bridge-group 1 to this instance
<pre>Bridgel(config-if)#bridge-group 1 instance 5</pre>	Assigning bridge-group 1 to this instance
<pre>Bridgel(config-if)#commit</pre>	Commit candidate configuration to be running configuration
<pre>Bridgel(config-if)#exit</pre>	Exit interface mode.
<pre>Bridgel(config)#interface eth4</pre>	Enter interface mode for eth4.
<pre>Bridgel(config-if)#bridge-group 1</pre>	Associating the interface to bridge-group 1
<pre>Bridgel(config-if)#bridge-group 1 instance 2</pre>	Assigning bridge-group 1 to this instance
<pre>Bridgel(config-if)#bridge-group 1 instance 3</pre>	Assigning bridge-group 1 to this instance
<pre>Bridgel(config-if)#bridge-group 1 instance 4</pre>	Assigning bridge-group 1 to this instance
<pre>Bridgel(config-if)#bridge-group 1 instance 5</pre>	Assigning bridge-group 1 to this instance

Bridge1 (config-if) #commit	Commit candidate configuration to be running configuration
Bridge1 (config-if) #exit	Exit interface mode.
Bridge1 (config) #interface eth5	Enter interface mode for eth5.
Bridge1 (config-if) #bridge-group 1	Associating the interface to bridge-group 1
Bridge1 (config-if) #bridge-group 1 instance 2	Assigning bridge-group 1 to this instance
Bridge1 (config-if) #bridge-group 1 instance 3	Assigning bridge-group 1 to this instance
Bridge1 (config-if) #bridge-group 1 instance 4	Assigning bridge-group 1 to this instance
Bridge1 (config-if) #bridge-group 1 instance 5	Assigning bridge-group 1 to this instance
Bridge1 (config-if) #commit	Commit candidate configuration to be running configuration
Bridge1 (config-if) #exit	Exit interface mode.

## Bridge 2

Bridge2#configure terminal	Enter configure mode.
Bridge2 (config) #bridge 2 protocol mstp	Add a bridge (2) to the multiple spanning
Bridge2 (config) #bridge 2 priority 4096	Assign priority to this bridge.
Bridge2 (config) #vlan database	Enter the VLAN configuration mode.
Bridge2 (config-vlan) #vlan 2 bridge 2 state enable	Enable the state of VLAN 2 on bridge 2. Specifying an enable state allows forwarding of frames over VLAN 2 on bridge 2.
Bridge2 (config-vlan) #vlan 3 bridge 2 state enable	Enable the state of VLAN 3 on bridge 2. Specifying an enable state allows forwarding of frames over VLAN 3 on bridge 2
Bridge2 (config-vlan) #vlan 4 bridge 2 state enable	Enable the state of VLAN 4 on bridge 2. Specifying an enable state allows forwarding of frames over VLAN 4 on bridge 2
Bridge2 (config-vlan) #vlan 5 bridge 2 state enable	Enable the state of VLAN 5 on bridge 2. Specifying an enable state allows forwarding of frames over VLAN 5 on bridge 2
Bridge2 (config-vlan) #commit	Commit candidate configuration to be running configuration
Bridge2 (config-vlan) #exit	Exit the VLAN configuration mode.
Bridge2 (config) #spanning-tree mst configuration	Enter the Multiple Spanning Tree configuration mode
Bridge2 (config-mst) #bridge 2 instance 2 vlan 2	Create an instance of VLAN. The VLANs must be created before being associating with an MST instance (MSTI). If the VLAN range is not specified the MSTI will not be created.
Bridge2 (config-mst) #bridge 2 instance 3 vlan 3	same as mention above.
Bridge2 (config-mst) #bridge 2 instance 4 vlan 4	same as mention above.
Bridge2 (config-mst) #bridge 2 instance 5 vlan 5	same as mention above.
Bridge2 (config-mst) #commit	Commit candidate configuration to be running configuration
Bridge2 (config-mst) #exit	Exit MST Configuration mode.
Bridge2 (config) #interface eth2	Enter interface mode for eth2

## MSTP Configuration

Bridge2 (config-if) #bridge-group 2	Associating the interface to bridge-group 2
Bridge2 (config-if) #bridge-group 2 instance 2	Assigning bridge-group 2 to this instance
Bridge2 (config-if) #bridge-group 2 instance 3	Assigning bridge-group 2 to this instance
Bridge2 (config-if) #bridge-group 2 instance 4	Assigning bridge-group 2 to this instance
Bridge2 (config-if) #bridge-group 2 instance 5	Assigning bridge-group 2 to this instance
Bridge2 (config-if) #commit	Commit candidate configuration to be running configuration
Bridge2 (config-if) #exit	Exit interface mode.
Bridge2 (config) #interface eth3	Enter interface mode for eth3
Bridge2 (config-if) #bridge-group 2	Associating the interface to bridge-group 2
Bridge2 (config-if) #bridge-group 2 instance 2	Assigning bridge-group 2 to this instance
Bridge2 (config-if) #bridge-group 2 instance 3	Assigning bridge-group 2 to this instance
Bridge2 (config-if) #bridge-group 2 instance 3 priority 16	Assign bridge-group 2 to this instance and set a port priority in order of 16 for it. MSTP uses port priority as a tiebreaker to determine which port should forward frames for a particular instance on a LAN, or which port should be the root port for an instance. A lower value implies better priority.
Bridge2 (config-if) #bridge-group 2 instance 4	Assigning bridge-group 2 to this instance
Bridge2 (config-if) #bridge-group 2 instance 4 priority 16	Assign bridge-group 2 to this instance and set a port priority in order of 16 for it. MSTP uses port priority as a tiebreaker to determine which port should forward frames for a particular instance on a LAN, or which port should be the root port for an instance. A lower value implies better priority
Bridge2 (config-if) #bridge-group 2 instance 5	Assigning bridge-group 2 to this instance
Bridge2 (config-if) #commit	Commit candidate configuration to be running configuration
Bridge2 (config-if) #exit	Exit interface mode
Bridge2 (config) #interface eth4	Enter interface mode for eth4
Bridge2 (config-if) #bridge-group 2	Associating the interface to bridge-group 2
Bridge2 (config-if) #bridge-group 2 instance 2	Assigning bridge-group 2 to this instance
Bridge2 (config-if) #bridge-group 2 instance 3	Assigning bridge-group 2 to this instance
Bridge2 (config-if) #bridge-group 2 instance 4	Assigning bridge-group 2 to this instance
Bridge2 (config-if) #bridge-group 2 instance 5	Assigning bridge-group 2 to this instance
Bridge2 (config-if) #commit	Commit candidate configuration to be running configuration
Bridge2 (config-if) #exit	Exit interface mode.
Bridge2 (config) #interface eth5	Enter interface mode for eth5
Bridge2 (config-if) #bridge-group 2	Associating the interface to bridge-group 2



Bridge2(config-if)#bridge-group 2 instance 2	Assigning bridge-group 2 to this instance
Bridge2(config-if)#bridge-group 2 instance 3	Assigning bridge-group 2 to this instance
Bridge2(config-if)#bridge-group 2 instance 4	Assigning bridge-group 2 to this instance
Bridge2(config-if)#bridge-group 2 instance 5	Assigning bridge-group 2 to this instance
Bridge2(config-if)#commit	Commit candidate configuration to be running configuration
Bridge2(config-if)#exit	Exit interface mode.

### Bridge 3

Bridge3#configure terminal	Enter configure mode.
Bridge3(config)#bridge 3 protocol mstp	Add a bridge (3) to the multiple spanning tree table
Bridge3(config)#vlan database	Enter the VLAN configuration mode.
Bridge3(config-vlan)#vlan 2 bridge 3 state enable	Enable the state of VLAN 2 on bridge 3. Specifying an enable state allows forwarding of frames over VLAN 2 on bridge 3.
Bridge3(config-vlan)#vlan 3 bridge 3 state enable	Enable the state of VLAN 3 on bridge 3. Specifying an enable state allows forwarding of frames over VLAN 3 on bridge 3.
Bridge3(config-vlan)#vlan 4 bridge 3 state enable	Enable the state of VLAN 4 on bridge 3. Specifying an enable state allows forwarding of frames over VLAN 4 on bridge 3.
Bridge3(config-vlan)#vlan 5 bridge 3 state enable	Enable the state of VLAN 5 on bridge 3. Specifying an enable state allows forwarding of frames over VLAN 5 on bridge 3.
Bridge3(config-vlan)#commit	Commit candidate configuration to be running configuration
Bridge3(config-vlan)#exit	Exit the VLAN configuration mode.
Bridge3(config)#spanning-tree mst configuration	Enter the Multiple Spanning Tree Configuration mode.
Bridge3(config-mst)#bridge 3 instance 2 vlan 2	Create an instance of VLAN. The VLANs must be created before being associating with an MST instance (MSTI). If the VLAN range is not specified the MSTI will not be created.
Bridge3(config-mst)#bridge 3 instance 3 vlan 3	same as mention above.
Bridge3(config-mst)#bridge 3 instance 4 vlan 4	same as mention above.
Bridge3(config-mst)#bridge 3 instance 5 vlan 5	same as mention above.
Bridge3(config-mst)#commit	Commit candidate configuration to be running configuration
Bridge3(config-mst)#exit	Exit MST Configuration mode.
Bridge3(config)#interface eth2	Enter interface mode for eth2

## MSTP Configuration

Bridge3(config-if)#bridge-group 3	Associating the interface to bridge-group 3
Bridge3(config-if)#bridge-group 3 instance 2	Assigning bridge-group 3 to this instance
Bridge3(config-if)#bridge-group 3 instance 3	Assigning bridge-group 3 to this instance
Bridge3(config-if)#bridge-group 3 instance 4	Assigning bridge-group 3 to this instance
Bridge3(config-if)#bridge-group 3 instance 5	Assigning bridge-group 3 to this instance
Bridge3(config-if)#commit	Commit candidate configuration to be running configuration
Bridge3(config-if)#exit	Exit interface mode.
Bridge3(config)#interface eth3	Enter interface mode for eth3
Bridge3(config-if)#bridge-group 3	Associating the interface to bridge-group 3
Bridge3(config-if)#bridge-group 3 instance 2	Assigning bridge-group 3 to this instance
Bridge3(config-if)#bridge-group 3 instance 3	Assigning bridge-group 3 to this instance
Bridge3(config-if)#bridge-group 3 instance 4	Assigning bridge-group 3 to this instance
Bridge3(config-if)#bridge-group 3 instance 5	Assigning bridge-group 3 to this instance
Bridge3(config-if)#commit	Commit candidate configuration to be running configuration
Bridge3(config-if)#exit	Exit interface mode.

## Bridge 4

Bridge4#configure terminal	Enter configure mode.
Bridge4(config)#bridge 4 protocol mstp	Add a bridge (4) to the multiple spanning tree table
Bridge4(config)#vlan database	Enter the VLAN configuration mode.
Bridge4(config-vlan)#vlan 2 bridge 4 state enable	Enable the state of VLAN 2 on bridge 4. Specifying an enable state allows forwarding of frames over VLAN 2 on bridge 4.
Bridge4(config-vlan)#vlan 3 bridge 4 state enable	Enable the state of VLAN 3 on bridge 4. Specifying an enable state allows forwarding of frames over VLAN 3 on bridge 4.
Bridge4(config-vlan)#vlan 4 bridge 4 state enable	Enable the state of VLAN 4 on bridge 4. Specifying an enable state allows forwarding of frames over VLAN 4 on bridge 4.
Bridge4(config-vlan)#vlan 5 bridge 4 state enable	Enable the state of VLAN 5 on bridge 4. Specifying an enable state allows forwarding of frames over VLAN 5 on bridge 4.
Bridge4(config-vlan)#commit	Commit candidate configuration to be running configuration
Bridge4(config-vlan)#exit	Exit the VLAN configuration mode.
Bridge4(config)#spanning-tree mst configuration	Enter the Multiple Spanning Tree Configuration mode.
Bridge4(config-mst)#bridge 4 instance 2 vlan 2	Create an instance of VLAN. The VLANs must be created before being associating with an MST instance (MSTI). If the VLAN range is not specified the MSTI will not be created.
Bridge4(config-mst)#bridge 4 instance 3 vlan 3	same as mention above.

Bridge4(config-mst)#bridge 4 instance 4 vlan 4	same as mention above.
Bridge4(config-mst)#bridge 4 instance 5 vlan 5	same as mention above.
Bridge4(config-mst)#commit	Commit candidate configuration to be running configuration
Bridge4(config-mst)#exit	Exit MST Configuration mode.
Bridge4(config)#interface eth2	Enter interface mode for eth2
Bridge4(config-if)#bridge-group 4	Associating the interface to bridge-group 4
Bridge4(config-if)#bridge-group 4 instance 2	Assigning bridge-group 4 to this instance
Bridge4(config-if)#bridge-group 4 instance 3	Assigning bridge-group 4 to this instance
Bridge4(config-if)#bridge-group 4 instance 4	Assigning bridge-group 4 to this instance
Bridge4(config-if)#bridge-group 4 instance 5	Assigning bridge-group 4 to this instance
Bridge4(config-if)#commit	Commit candidate configuration to be running configuration
Bridge4(config-if)#exit	Exit interface mode.
Bridge4(config)#interface eth3	Enter interface mode for eth3
Bridge4(config-if)#bridge-group 4	Associating the interface to bridge-group 4
Bridge4(config-if)#bridge-group 4 instance 2	Assigning bridge-group 4 to this instance
Bridge4(config-if)#bridge-group 4 instance 3	Assigning bridge-group 4 to this instance
Bridge4(config-if)#bridge-group 4 instance 4	Assigning bridge-group 4 to this instance
Bridge4(config-if)#bridge-group 4 instance 5	Assigning bridge-group 4 to this instance
Bridge4(config-if)#commit	Commit candidate configuration to be running configuration
Bridge4(config-if)#exit	Exit interface mode.
Bridge4(config)#interface eth4	Enter interface mode for eth4
Bridge4(config-if)#bridge-group 4	Associating the interface to bridge-group 4
Bridge4(config-if)#bridge-group 4 instance 2	Assigning bridge-group 4 to this instance
Bridge4(config-if)#bridge-group 4 instance 3	Assigning bridge-group 4 to this instance
Bridge4(config-if)#bridge-group 4 instance 4	Assigning bridge-group 4 to this instance
Bridge4(config-if)#bridge-group 4 instance 5	Assigning bridge-group 4 to this instance
Bridge4(config-if)#commit	Commit candidate configuration to be running configuration
Bridge4(config-if)#exit	Exit interface mode.
Bridge4(config)#interface eth5	Enter interface mode for eth5
Bridge4(config-if)#bridge-group 4	Associating the interface to bridge-group 4
Bridge4(config-if)#bridge-group 4 instance 2	Assigning bridge-group 4 to this instance

## MSTP Configuration

Bridge4(config-if)#bridge-group 4 instance 3	Assigning bridge-group 4 to this instance
Bridge4(config-if)#bridge-group 4 instance 4	Assigning bridge-group 4 to this instance
Bridge4(config-if)#bridge-group 4 instance 5	Assigning bridge-group 4 to this instance
Bridge4(config-if)#commit	Commit candidate configuration to be running configuration
Bridge4(config-if)#exit	Exit interface mode.

## Validation

show spanning-tree, show spanning-tree mst detail

```
#show spanning-tree mst detail
% 1: Bridge up - Spanning Tree Enabled - topology change detected
% 1: CIST Root Path Cost 0 - CIST Root Port 3 - CIST Bridge Priority 32768
% 1: Forward Delay 15 - Hello Time 2 - Max Age 20 - Transmit Hold Count 6 -
Max-hops 20
% 1: CIST Root Id 1000525400d15789
% 1: CIST Reg Root Id 1000525400d15789
% 1: CIST Bridge Id 8000525400244323
% 1: 26 topology change(s) - last topology change Mon Mar 4 12:58:35 2019

% 1: portfast bpdu-filter disabled
% 1: portfast bpdu-guard disabled
% 1: portfast errdisable timeout disabled
% 1: portfast errdisable timeout interval 300 sec
% eth1: Port Number 3 - Ifindex 3 - Port Id 0x8003 - Role Rootport - State
Forwarding
% eth1: Designated External Path Cost 0 -Internal Path Cost 20000
% eth1: Configured Path Cost 20000 - Add type Explicit ref count 5
% eth1: Designated Port Id 0x8003 - CIST Priority 128 -
% eth1: CIST Root 1000525400d15789
% eth1: Regional Root 1000525400d15789
% eth1: Designated Bridge 1000525400d15789
% eth1: Message Age 0 - Max Age 20
% eth1: CIST Hello Time 2 - Forward Delay 15
% eth1: CIST Forward Timer 0 - Msg Age Timer 5 - Hello Timer 0 - topo change
timer 0
% eth1: forward-transitions 1
% eth1: Version Multiple Spanning Tree Protocol - Received MSTP - Send MSTP
% eth1: No portfast configured - Current portfast off
% eth1: bpdu-guard default - Current bpdu-guard off
% eth1: bpdu-filter default - Current bpdu-filter off
% eth1: no root guard configured - Current root guard off
% eth1: Configured Link Type point-to-point - Current point-to-point
% eth1: No auto-edge configured - Current port Auto Edge off
%
% eth2: Port Number 4 - Ifindex 4 - Port Id 0x8004 - Role Alternate - State
Discarding
% eth2: Designated External Path Cost 0 -Internal Path Cost 20000
% eth2: Configured Path Cost 20000 - Add type Explicit ref count 5
% eth2: Designated Port Id 0x8004 - CIST Priority 128 -
% eth2: CIST Root 1000525400d15789
% eth2: Regional Root 1000525400d15789
```

```
% eth2: Designated Bridge 1000525400d15789
% eth2: Message Age 0 - Max Age 20
% eth2: CIST Hello Time 2 - Forward Delay 15
% eth2: CIST Forward Timer 0 - Msg Age Timer 5 - Hello Timer 1 - topo change
timer 0
% eth2: forward-transitions 2
% eth2: Version Multiple Spanning Tree Protocol - Received MSTP - Send MSTP
% eth2: No portfast configured - Current portfast off
% eth2: bpdu-guard default - Current bpdu-guard off
% eth2: bpdu-filter default - Current bpdu-filter off
% eth2: no root guard configured - Current root guard off
% eth2: Configured Link Type point-to-point - Current point-to-point
% eth2: No auto-edge configured - Current port Auto Edge off
%
% eth3: Port Number 5 - Ifindex 5 - Port Id 0x8005 - Role Designated - State
Forwarding
% eth3: Designated External Path Cost 0 -Internal Path Cost 20000
% eth3: Configured Path Cost 20000 - Add type Explicit ref count 5
% eth3: Designated Port Id 0x8005 - CIST Priority 128 -
% eth3: CIST Root 1000525400d15789
% eth3: Regional Root 1000525400d15789
% eth3: Designated Bridge 8000525400244323
% eth3: Message Age 0 - Max Age 20
% eth3: CIST Hello Time 2 - Forward Delay 15
% eth3: CIST Forward Timer 0 - Msg Age Timer 0 - Hello Timer 1 - topo change
timer 0
% eth3: forward-transitions 3
% eth3: Version Multiple Spanning Tree Protocol - Received None - Send MSTP
% eth3: No portfast configured - Current portfast off
% eth3: bpdu-guard default - Current bpdu-guard off
% eth3: bpdu-filter default - Current bpdu-filter off
% eth3: no root guard configured - Current root guard off
% eth3: Configured Link Type point-to-point - Current point-to-point
% eth3: No auto-edge configured - Current port Auto Edge off
%
% eth4: Port Number 6 - Ifindex 6 - Port Id 0x8006 - Role Designated - State
Forwarding
% eth4: Designated External Path Cost 0 -Internal Path Cost 20000
% eth4: Configured Path Cost 20000 - Add type Explicit ref count 5
% eth4: Designated Port Id 0x8006 - CIST Priority 128 -
% eth4: CIST Root 1000525400d15789
% eth4: Regional Root 1000525400d15789
% eth4: Designated Bridge 8000525400244323
% eth4: Message Age 0 - Max Age 20
% eth4: CIST Hello Time 2 - Forward Delay 15
% eth4: CIST Forward Timer 0 - Msg Age Timer 0 - Hello Timer 1 - topo change
timer 0
% eth4: forward-transitions 3
% eth4: Version Multiple Spanning Tree Protocol - Received None - Send MSTP
% eth4: No portfast configured - Current portfast off
% eth4: bpdu-guard default - Current bpdu-guard off
% eth4: bpdu-filter default - Current bpdu-filter off
% eth4: no root guard configured - Current root guard off
% eth4: Configured Link Type point-to-point - Current point-to-point
% eth4: No auto-edge configured - Current port Auto Edge off
%
% Instance 2: Vlans: 2
```

## MSTP Configuration

---

```
% 1: MSTI Root Path Cost 0 -MSTI Root Port 0 - MSTI Bridge Priority 32768
% 1: MSTI Root Id 8002525400244323
% 1: MSTI Bridge Id 8002525400244323
% eth1: Port Number 3 - Ifindex 3 - Port Id 0x8003 - Role Designated - State
Forwarding
% eth1: Designated Internal Path Cost 0 - Designated Port Id 0x8003
% eth1: Configured Internal Path Cost 20000
% eth1: Configured CST External Path cost 20000
% eth1: CST Priority 128 - MSTI Priority 128
% eth1: Designated Root 8002525400244323
% eth1: Designated Bridge 8002525400244323
% eth1: Message Age 0
% eth1: Hello Time 2 - Forward Delay 15
% eth1: Forward Timer 0 - Msg Age Timer 0 - Hello Timer 0

% eth2: Port Number 4 - Ifindex 4 - Port Id 0x8004 - Role Designated - State
Forwarding
% eth2: Designated Internal Path Cost 0 - Designated Port Id 0x8004
% eth2: Configured Internal Path Cost 20000
% eth2: Configured CST External Path cost 20000
% eth2: CST Priority 128 - MSTI Priority 128
% eth2: Designated Root 8002525400244323
% eth2: Designated Bridge 8002525400244323
% eth2: Message Age 0
% eth2: Hello Time 2 - Forward Delay 15
% eth2: Forward Timer 0 - Msg Age Timer 0 - Hello Timer 1

% eth3: Port Number 5 - Ifindex 5 - Port Id 0x8005 - Role Designated - State
Forwarding
% eth3: Designated Internal Path Cost 0 - Designated Port Id 0x8005
% eth3: Configured Internal Path Cost 20000
% eth3: Configured CST External Path cost 20000
% eth3: CST Priority 128 - MSTI Priority 128
% eth3: Designated Root 8002525400244323
% eth3: Designated Bridge 8002525400244323
% eth3: Message Age 0
% eth3: Hello Time 2 - Forward Delay 15
% eth3: Forward Timer 0 - Msg Age Timer 0 - Hello Timer 1

% eth4: Port Number 6 - Ifindex 6 - Port Id 0x8006 - Role Designated - State
Forwarding
% eth4: Designated Internal Path Cost 0 - Designated Port Id 0x8006
% eth4: Configured Internal Path Cost 20000
% eth4: Configured CST External Path cost 20000
% eth4: CST Priority 128 - MSTI Priority 128
% eth4: Designated Root 8002525400244323
% eth4: Designated Bridge 8002525400244323
% eth4: Message Age 0
% eth4: Hello Time 2 - Forward Delay 15
% eth4: Forward Timer 0 - Msg Age Timer 0 - Hello Timer 1

% Instance 3: Vlans: 3

% 1: MSTI Root Path Cost 0 -MSTI Root Port 0 - MSTI Bridge Priority 32768
% 1: MSTI Root Id 8003525400244323
```

---

```
% 1: MSTI Bridge Id 8003525400244323
% eth1: Port Number 3 - Ifindex 3 - Port Id 0x8003 - Role Masterport - State
Forwarding
% eth1: Designated Internal Path Cost 0 - Designated Port Id 0x8003
% eth1: Configured Internal Path Cost 20000
% eth1: Configured CST External Path cost 20000
% eth1: CST Priority 128 - MSTI Priority 128
% eth1: Designated Root 8003525400244323
% eth1: Designated Bridge 8003525400244323
% eth1: Message Age 0
% eth1: Hello Time 2 - Forward Delay 15
% eth1: Forward Timer 0 - Msg Age Timer 0 - Hello Timer 0

% eth2: Port Number 4 - Ifindex 4 - Port Id 0x8004 - Role Designated - State
Forwarding
% eth2: Designated Internal Path Cost 0 - Designated Port Id 0x8004
% eth2: Configured Internal Path Cost 20000
% eth2: Configured CST External Path cost 20000
% eth2: CST Priority 128 - MSTI Priority 128
% eth2: Designated Root 8003525400244323
% eth2: Designated Bridge 8003525400244323
% eth2: Message Age 0
% eth2: Hello Time 2 - Forward Delay 15
% eth2: Forward Timer 0 - Msg Age Timer 0 - Hello Timer 1

% eth3: Port Number 5 - Ifindex 5 - Port Id 0x8005 - Role Designated - State
Forwarding
% eth3: Designated Internal Path Cost 0 - Designated Port Id 0x8005
% eth3: Configured Internal Path Cost 20000
% eth3: Configured CST External Path cost 20000
% eth3: CST Priority 128 - MSTI Priority 128
% eth3: Designated Root 8003525400244323
% eth3: Designated Bridge 8003525400244323
% eth3: Message Age 0
% eth3: Hello Time 2 - Forward Delay 15
% eth3: Forward Timer 0 - Msg Age Timer 0 - Hello Timer 1

% eth4: Port Number 6 - Ifindex 6 - Port Id 0x8006 - Role Designated - State
Forwarding
% eth4: Designated Internal Path Cost 0 - Designated Port Id 0x8006
% eth4: Configured Internal Path Cost 20000
% eth4: Configured CST External Path cost 20000
% eth4: CST Priority 128 - MSTI Priority 128
% eth4: Designated Root 8003525400244323
% eth4: Designated Bridge 8003525400244323
% eth4: Message Age 0
% eth4: Hello Time 2 - Forward Delay 15
% eth4: Forward Timer 0 - Msg Age Timer 0 - Hello Timer 1

% Instance 4: Vlans: 4

% 1: MSTI Root Path Cost 0 -MSTI Root Port 0 - MSTI Bridge Priority 32768
% 1: MSTI Root Id 8004525400244323
% 1: MSTI Bridge Id 8004525400244323
% eth1: Port Number 3 - Ifindex 3 - Port Id 0x8003 - Role Masterport - State
Forwarding
% eth1: Designated Internal Path Cost 0 - Designated Port Id 0x8003
```

---

## MSTP Configuration

---

```
% eth1: Configured Internal Path Cost 20000
% eth1: Configured CST External Path cost 20000
% eth1: CST Priority 128 - MSTI Priority 128
% eth1: Designated Root 8004525400244323
% eth1: Designated Bridge 8004525400244323
% eth1: Message Age 0
% eth1: Hello Time 2 - Forward Delay 15
% eth1: Forward Timer 0 - Msg Age Timer 0 - Hello Timer 0

% eth2: Port Number 4 - Ifindex 4 - Port Id 0x8004 - Role Designated - State
Forwarding
% eth2: Designated Internal Path Cost 0 - Designated Port Id 0x8004
% eth2: Configured Internal Path Cost 20000
% eth2: Configured CST External Path cost 20000
% eth2: CST Priority 128 - MSTI Priority 128
% eth2: Designated Root 8004525400244323
% eth2: Designated Bridge 8004525400244323
% eth2: Message Age 0
% eth2: Hello Time 2 - Forward Delay 15
% eth2: Forward Timer 0 - Msg Age Timer 0 - Hello Timer 1

% eth3: Port Number 5 - Ifindex 5 - Port Id 0x8005 - Role Designated - State
Forwarding
% eth3: Designated Internal Path Cost 0 - Designated Port Id 0x8005
% eth3: Configured Internal Path Cost 20000
% eth3: Configured CST External Path cost 20000
% eth3: CST Priority 128 - MSTI Priority 128
% eth3: Designated Root 8004525400244323
% eth3: Designated Bridge 8004525400244323
% eth3: Message Age 0
% eth3: Hello Time 2 - Forward Delay 15
% eth3: Forward Timer 0 - Msg Age Timer 0 - Hello Timer 1

% eth4: Port Number 6 - Ifindex 6 - Port Id 0x8006 - Role Designated - State
Forwarding
% eth4: Designated Internal Path Cost 0 - Designated Port Id 0x8006
% eth4: Configured Internal Path Cost 20000
% eth4: Configured CST External Path cost 20000
% eth4: CST Priority 128 - MSTI Priority 128
% eth4: Designated Root 8004525400244323
% eth4: Designated Bridge 8004525400244323
% eth4: Message Age 0
% eth4: Hello Time 2 - Forward Delay 15
% eth4: Forward Timer 0 - Msg Age Timer 0 - Hello Timer 1

% Instance 5: Vlans: 5

% 1: MSTI Root Path Cost 0 -MSTI Root Port 0 - MSTI Bridge Priority 32768
% 1: MSTI Root Id 8005525400244323
% 1: MSTI Bridge Id 8005525400244323
% eth1: Port Number 3 - Ifindex 3 - Port Id 0x8003 - Role Masterport - State
Forwarding
% eth1: Designated Internal Path Cost 0 - Designated Port Id 0x8003
% eth1: Configured Internal Path Cost 20000
% eth1: Configured CST External Path cost 20000
% eth1: CST Priority 128 - MSTI Priority 128
```



```
% eth1: Designated Root 8005525400244323
% eth1: Designated Bridge 8005525400244323
% eth1: Message Age 0
% eth1: Hello Time 2 - Forward Delay 15
% eth1: Forward Timer 0 - Msg Age Timer 0 - Hello Timer 0

% eth2: Port Number 4 - Ifindex 4 - Port Id 0x8004 - Role Designated - State
Forwarding
% eth2: Designated Internal Path Cost 0 - Designated Port Id 0x8004
% eth2: Configured Internal Path Cost 20000
% eth2: Configured CST External Path cost 20000
% eth2: CST Priority 128 - MSTI Priority 128
% eth2: Designated Root 8005525400244323
% eth2: Designated Bridge 8005525400244323
% eth2: Message Age 0
% eth2: Hello Time 2 - Forward Delay 15
% eth2: Forward Timer 0 - Msg Age Timer 0 - Hello Timer 1

% eth3: Port Number 5 - Ifindex 5 - Port Id 0x8005 - Role Designated - State
Forwarding
% eth3: Designated Internal Path Cost 0 - Designated Port Id 0x8005
% eth3: Configured Internal Path Cost 20000
% eth3: Configured CST External Path cost 20000
% eth3: CST Priority 128 - MSTI Priority 128
% eth3: Designated Root 8005525400244323
% eth3: Designated Bridge 8005525400244323
% eth3: Message Age 0
% eth3: Hello Time 2 - Forward Delay 15
% eth3: Forward Timer 0 - Msg Age Timer 0 - Hello Timer 1

% eth4: Port Number 6 - Ifindex 6 - Port Id 0x8006 - Role Designated - State
Forwarding
% eth4: Designated Internal Path Cost 0 - Designated Port Id 0x8006
% eth4: Configured Internal Path Cost 20000
% eth4: Configured CST External Path cost 20000
% eth4: CST Priority 128 - MSTI Priority 128
% eth4: Designated Root 8005525400244323
% eth4: Designated Bridge 8005525400244323
% eth4: Message Age 0
% eth4: Hello Time 2 - Forward Delay 15
% eth4: Forward Timer 0 - Msg Age Timer 0 - Hello Timer 1

#show spanning-tree
% 1: Bridge up - Spanning Tree Enabled - topology change detected
% 1: CIST Root Path Cost 0 - CIST Root Port 3 - CIST Bridge Priority 32768
% 1: Forward Delay 15 - Hello Time 2 - Max Age 20 - Transmit Hold Count 6 -
Max-hops 20
% 1: CIST Root Id 1000525400d15789
% 1: CIST Reg Root Id 1000525400d15789
% 1: CIST Bridge Id 8000525400244323
% 1: 26 topology change(s) - last topology change Mon Mar 4 12:58:35 2019

% 1: portfast bpdu-filter disabled
% 1: portfast bpdu-guard disabled
% 1: portfast errdisable timeout disabled
% 1: portfast errdisable timeout interval 300 sec
```

## MSTP Configuration

---

```
% eth1: Port Number 3 - Ifindex 3 - Port Id 0x8003 - Role Rootport - State
Forwarding
% eth1: Designated External Path Cost 0 -Internal Path Cost 20000
% eth1: Configured Path Cost 20000 - Add type Explicit ref count 5
% eth1: Designated Port Id 0x8003 - CIST Priority 128 -
% eth1: CIST Root 1000525400d15789
% eth1: Regional Root 1000525400d15789
% eth1: Designated Bridge 1000525400d15789
% eth1: Message Age 0 - Max Age 20
% eth1: CIST Hello Time 2 - Forward Delay 15
% eth1: CIST Forward Timer 0 - Msg Age Timer 5 - Hello Timer 1 - topo change
timer 0
% eth1: forward-transitions 1
% eth1: Version Multiple Spanning Tree Protocol - Received MSTP - Send MSTP
% eth1: No portfast configured - Current portfast off
% eth1: bpdu-guard default - Current bpdu-guard off
% eth1: bpdu-filter default - Current bpdu-filter off
% eth1: no root guard configured - Current root guard off
% eth1: Configured Link Type point-to-point - Current point-to-point
% eth1: No auto-edge configured - Current port Auto Edge off
%
% eth2: Port Number 4 - Ifindex 4 - Port Id 0x8004 - Role Alternate - State
Discarding
% eth2: Designated External Path Cost 0 -Internal Path Cost 20000
% eth2: Configured Path Cost 20000 - Add type Explicit ref count 5
% eth2: Designated Port Id 0x8004 - CIST Priority 128 -
% eth2: CIST Root 1000525400d15789
% eth2: Regional Root 1000525400d15789
% eth2: Designated Bridge 1000525400d15789
% eth2: Message Age 0 - Max Age 20
% eth2: CIST Hello Time 2 - Forward Delay 15
% eth2: CIST Forward Timer 0 - Msg Age Timer 5 - Hello Timer 0 - topo change
timer 0
% eth2: forward-transitions 2
% eth2: Version Multiple Spanning Tree Protocol - Received MSTP - Send MSTP
% eth2: No portfast configured - Current portfast off
% eth2: bpdu-guard default - Current bpdu-guard off
% eth2: bpdu-filter default - Current bpdu-filter off
% eth2: no root guard configured - Current root guard off
% eth2: Configured Link Type point-to-point - Current point-to-point
% eth2: No auto-edge configured - Current port Auto Edge off
%
% eth3: Port Number 5 - Ifindex 5 - Port Id 0x8005 - Role Designated - State
Forwarding
% eth3: Designated External Path Cost 0 -Internal Path Cost 20000
% eth3: Configured Path Cost 20000 - Add type Explicit ref count 5
% eth3: Designated Port Id 0x8005 - CIST Priority 128 -
% eth3: CIST Root 1000525400d15789
% eth3: Regional Root 1000525400d15789
% eth3: Designated Bridge 8000525400244323
% eth3: Message Age 0 - Max Age 20
% eth3: CIST Hello Time 2 - Forward Delay 15
% eth3: CIST Forward Timer 0 - Msg Age Timer 0 - Hello Timer 1 - topo change
timer 0
% eth3: forward-transitions 3
% eth3: Version Multiple Spanning Tree Protocol - Received None - Send MSTP
% eth3: No portfast configured - Current portfast off
% eth3: bpdu-guard default - Current bpdu-guard off
```

---

```
% eth3: bpdu-filter default - Current bpdu-filter off
% eth3: no root guard configured - Current root guard off
% eth3: Configured Link Type point-to-point - Current point-to-point
% eth3: No auto-edge configured - Current port Auto Edge off
%
% eth4: Port Number 6 - Ifindex 6 - Port Id 0x8006 - Role Designated - State
Forwarding
% eth4: Designated External Path Cost 0 -Internal Path Cost 20000
% eth4: Configured Path Cost 20000 - Add type Explicit ref count 5
% eth4: Designated Port Id 0x8006 - CIST Priority 128 -
% eth4: CIST Root 1000525400d15789
% eth4: Regional Root 1000525400d15789
% eth4: Designated Bridge 8000525400244323
% eth4: Message Age 0 - Max Age 20
% eth4: CIST Hello Time 2 - Forward Delay 15
% eth4: CIST Forward Timer 0 - Msg Age Timer 0 - Hello Timer 0 - topo change
timer 0
% eth4: forward-transitions 3
% eth4: Version Multiple Spanning Tree Protocol - Received None - Send MSTP
% eth4: No portfast configured - Current portfast off
% eth4: bpdu-guard default - Current bpdu-guard off
% eth4: bpdu-filter default - Current bpdu-filter off
% eth4: no root guard configured - Current root guard off
% eth4: Configured Link Type point-to-point - Current point-to-point
% eth4: No auto-edge configured - Current port Auto Edge off%
#
```



## CHAPTER 10 Port Security Configuration

The Port Security feature allows network administrators to block unauthorized access to the network. Network administrators can configure each port of the switch to allow network access from only secured MACs, so that the switch forwards traffic from only secured MACs.

Users can limit each port's ingress traffic by limiting MAC addresses (source MACs) that are used to send traffic into ports. Port Security enables users to configure the maximum number of secured MACs for each port. Switches learn secured MAC dynamically (learned by switch during traffic inflow) or statically (User configured MACs). Dynamically Learned or statically programmed MAC addresses cannot exceed the maximum number of secured MACs configured for a particular port. Once the switch reaches the maximum limit for secured MACs, traffic from all other MAC addresses are dropped.

The violated MACs are logged in syslog messages. Refer to `cpu queue portsec-drop` using the command `show interface cpu counter queue-stats` for information on the number of violated MACs.

### Secured MACs Learned Dynamically



**Figure 10-23: Secured MACs learned dynamically**

Send Layer-2 traffic with incremental source MAC of 100 and with VLAN 100 from Edge Network node and since max limit is configured as 3 – only 3 secure MAC addresses will be learned by SW1.

#### SW1

<code>#configure terminal</code>	Enter configure mode.
<code>(config)#hostname SW1</code>	Set the host name
<code>(config)#bridge 1 protocol rstp vlan-bridge</code>	Create a RSTP VLAN bridge on customer side
<code>(config)#vlan 2-200 bridge 1 state enable</code>	Configure VLAN for the bridge
<code>(config)#interface ge1</code>	Enter interface mode
<code>(config-if)#switchport</code>	Make the interface Layer 2
<code>(config-if)#bridge-group 1</code>	Associate the interface to bridge
<code>(config-if)#switchport mode hybrid</code>	Configure the mode as trunk
<code>(config-if)#switchport hybrid allowed vlan all</code>	Configure allowed VLAN all on the interface
<code>(config-if)#switchport port-security</code>	Enable port security mode dynamic
<code>(config-if)#switchport port-security maximum 3</code>	Limit secure MAC to 3 mac addresses.
<code>(config-if)#commit</code>	Commit candidate configuration to be running configuration

## Port Security Configuration

---

(config-if)#exit	Exit interface mode
(config)#interface ge2	Enter interface mode
(config-if)#switchport	Make the interface Layer 2
(config-if)#bridge-group 1	Associate the interface to bridge
(config-if)#switchport mode hybrid	Configure the mode as trunk
(config-if)#switchport hybrid allowed vlan all	Configure allowed VLAN all on the interface
(config-if)#commit	Commit candidate configuration to be running configuration
(config-if)#exit	Exit interface mode
(config)#logging monitor 7	Enable logging level as 7 for debugging

---

## Validation

Validation commands are "show port-security," "show port-security interface <ifname>," "show mac address-table count bridge 1," "show bridge," and "show mac address-table bridge 1."

```
SW1#show port-security
```

```
Port      port-security mode  MAC limit  CVLAN  SVLAN  static secure MAC
-----+-----+-----+-----+-----+-----+-----
ge1      dynamic              3
```

```
SW1#show port-security interface ge1
```

```
Port Security Mode      : Dynamic
Secure MAC limit        : 3
Static Secure MAC list  :
CVLAN  SVLAN  MAC Address
-----+-----+-----
```

```
SW1#show mac address-table count bridge 1
```

```
MAC Entries for all vlans:
Dynamic Address Count: 3
Static (User-defined) Unicast MAC Address Count: 0
Static (User-defined) Multicast MAC Address Count: 0
Total MAC Addresses in Use: 3
```

```
SW1#show bridge
```

Ageout time is global and if something is configured for vxlan then it will be affected here also

```
Bridge  CVLAN  SVLAN  BVLAN  Port      MAC Address      FWD  Time-out
-----+-----+-----+-----+-----+-----+-----+-----
1        100      100      ge1     0000.0300.0500  1      100
1        100      100      ge1     0000.0300.055b  1      100
1        100      100      ge1     0000.0300.055c  1      100
```

```
SW1#show mac address-table bridge 1
```

```
VLAN  MAC Address      Type      Ports  Port-security
-----+-----+-----+-----+-----
100   0000.0300.0500  dynamic  ge1    Enable
100   0000.0300.055b  dynamic  ge1    Enable
```

```
100 0000.0300.055c dynamic ge1 Enable  
SW1#
```

## Secured MAC Addresses Learned Statically

1. Stop the traffic from Edge Network node and do “clear mac address-table dynamic bridge 1” on SW1.
2. Verify all dynamic secured MAC addresses are cleared.
3. Configure 3 static secure MAC addresses using the commands below in port security configured interface.
4. Try to add a fourth static secure MAC address.
5. Verify operator log message is displayed, saying “port security mac limit reached.”

(config)#interface gel	Enter interface mode
(config-if)#switchport port-security mac-address 0000.0000.aaaa vlanId 100	Add static secure MAC address for VLAN 100 in interface mode
(config-if)#switchport port-security mac-address 0000.0000.aaab vlanId 100	Add static secure MAC address for VLAN 100 in interface mode
(config-if)#switchport port-security mac-address 0000.0000.aaac vlanId 100	Add static secure MAC address for VLAN 100 in interface mode
(config-if)#commit	Commit candidate configuration to be running configuration

## Validation

```
SW1#show port-security
Port      port-security mode  MAC limit  CVLAN  SVLAN  static secure MAC
-----+-----+-----+-----+-----+-----
gel      dynamic             3          100   100   0000.0000.aaaa
          100                100   0000.0000.aaab
          100                100   0000.0000.aaac
```

```
SW1#show port-security interface gel
Port Security Mode      : Dynamic
Secure MAC limit       : 3
Static Secure MAC list :
CVLAN  SVLAN  MAC Address
-----+-----+-----
100    100    0000.0000.aaaa
100    100    0000.0000.aaab
100    100    0000.0000.aaac
```

```
SW1#show mac address-table count bridge 1
MAC Entries for all vlans:
Dynamic Address Count: 0
Static (User-defined) Unicast MAC Address Count: 3
Static (User-defined) Multicast MAC Address Count: 0
Total MAC Addresses in Use: 3
```

```
SW1#show bridge
```



Ageout time is global and if something is configured for vxlan then it will be affected here also

Bridge	CVLAN	SVLAN	BVLAN	Port	MAC Address	FWD	Time-out
1	100			ge1	0000.0000.aaaa	1	-
1	100			ge1	0000.0000.aaab	1	-
1	100			ge1	0000.0000.aaac	1	-

SW1#show mac address-table bridge 1

VLAN	MAC Address	Type	Ports	Port-security
100	0000.0000.aaaa	static	ge1	Enable
100	0000.0000.aaab	static	ge1	Enable
100	0000.0000.aaac	static	ge1	Enable

SW1#

Remove the port-security configuration method using the two commands below:

```
(
config)#interface ge1
(config-if)#no switchport port-security
(config-if)#commit
```

config)#interface ge1	Enter interface mode
(config-if)#no switchport port-security	Set the port-security method to static.
(config-if)#commit	Commit candidate configuration to be running configuration

## Static Mode

Use the below command to configure the port-security method to static and configure static secure MAC addresses using the commands the in static port-security method, below.

```
(config)#interface ge1
(config-if)#switchport port-security static
(config-if)#switchport port-security max 3
(config-if)#switchport port-security mac-address 0000.0000.aaaa vlanId 100
(config-if)#switchport port-security mac-address 0000.0000.aaab vlanId 100
(config-if)#switchport port-security mac-address 0000.0000.aaac vlanId 100
(config-if)#commit
```

(config)#interface ge1	Enter interface mode
(config-if)#switchport port-security static	Set the port-security method as static.
(config-if)#switchport port-security max 3	Limit static secure MAC to 3 mac addresses.
(config-if)#switchport port-security mac-address 0000.0000.aaaa vlanId 100	Add static secure MAC address for VLAN 100 in interface mode.
(config-if)#switchport port-security mac-address 0000.0000.aaab vlanId 100	Add static secure MAC address for VLAN 100 in interface mode.
(config-if)#switchport port-security mac-address 0000.0000.aaac vlanId 100	Add static secure MAC address for VLAN 100 in interface mode .
(config-if)#commit	Commit candidate configuration to be running configuration

Verify the 3 secure static MAC addresses are added in interface ge1 using show running-config and also verify the port-security method should be static using below show commands.

## Validation

```
SW1#show running-config interface ge1
interface ge1
 switchport
 bridge-group 1
 switchport mode hybrid
```

## Port Security Configuration

---

```
switchport hybrid allowed vlan all
switchport port-security static
switchport port-security maximum 3
switchport port-security mac-address 0000.0000.aaaa vlanId 100
switchport port-security mac-address 0000.0000.aaab vlanId 100
switchport port-security mac-address 0000.0000.aaac vlanId 100
```

SW1#show port-security

Port	port-security mode	MAC limit	CVLAN	SVLAN	static secure MAC
ge1	static	3	100		0000.0000.aaaa
			100		0000.0000.aaab
			100		0000.0000.aaac

SW1#show port-security interface ge1

```
Port Security Mode      : Static
Secure MAC limit       : 3
Static Secure MAC list :
CVLAN  SVLAN  MAC Address
```

CVLAN	SVLAN	MAC Address
100		0000.0000.aaaa
100		0000.0000.aaab
100		0000.0000.aaac

SW1#show mac address-table count bridge 1

```
MAC Entries for all vlans:
Dynamic Address Count: 0
Static (User-defined) Unicast MAC Address Count: 3
Static (User-defined) Multicast MAC Address Count: 0
Total MAC Addresses in Use: 3
```

SW1#show bridge

Ageout time is global and if something is configured for vxlan then it will be affected here also

Bridge	CVLAN	SVLAN	BVLAN	Port	MAC Address	FWD	Time-out
1	100			ge1	0000.0000.aaaa	1	-
1	100			ge1	0000.0000.aaab	1	-
1	100			ge1	0000.0000.aaac	1	-

SW1#show mac address-table bridge 1

VLAN	MAC Address	Type	Ports	Port-security
100	0000.0000.aaaa	static	ge1	Enable
100	0000.0000.aaab	static	ge1	Enable
100	0000.0000.aaac	static	ge1	Enable

SW1#

Configure one more static secure MAC address on interface ge1 and try to verify "port security mac limit reached" operator log message is displayed.

Start sending Layer-2 traffic with incremental source MAC of 100 and with VLAN 100 from Edge Network node, and verify no dynamic secure MAC addresses are being learned using all the validation commands used.

## Port Security using MLAG

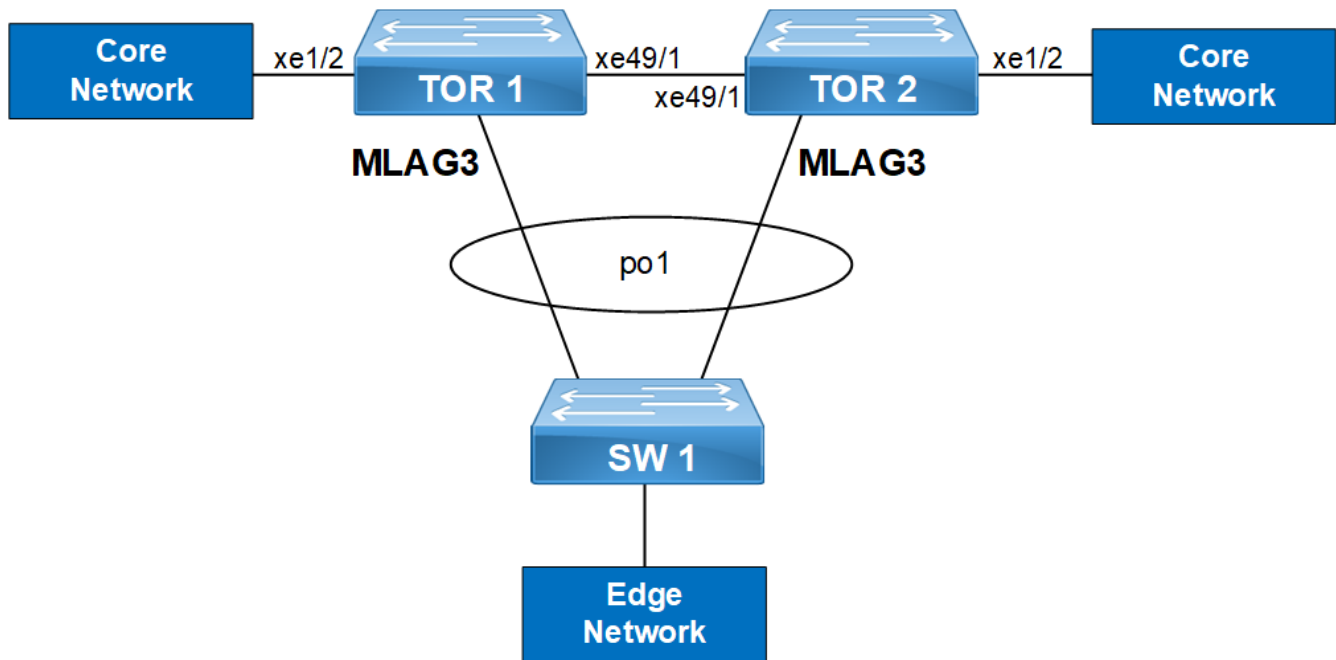

Figure 10-24: Port security with MLAG

### TOR1

#configure terminal	Enter configure mode
(config)#bridge 1 protocol provider-rstp edge	Create provider RSTP bridge
(config)#vlan 2-10 type customer bridge 1 state enable	Enabling customer vlan for bridge
(config)#vlan 2-10 type service point-point bridge 1 state enable	Enabling service vlan for bridge
(config)#cvlan registration table map1 bridge 1	Creating registration table
(config-cvlan-registation)#cvlan 2 svlan 2	Mapping CVLAN to SVLAN
(config-cvlan-registation)#cvlan 10 svlan 2	Mapping CVLAN to SVLAN
(config-cvlan-registation)#commit	Commit candidate configuration to be running configuration
(config-cvlan-registation)#exit	Exit registration table mode
(config)#interface mlag3	Entering MLAG interface
(config-if)#switchport	Configuring interface as switchport
(config-if)#commit	Commit candidate configuration to be running configuration
(config-if)#exit	Exit interface mode
(config)#interface po1	Entering dynamic lag interface
(config-if)#switchport	Configuring interface as switchport

(config-if)#bridge-group 1 spanning-tree disable	Associate the interface with bridge group 1 and disabling spanning-tree
(config-if)#switchport mode customer-edge hybrid	Set the switching characteristics of this interface to customer edge hybrid
(config-if)#switchport customer-edge hybrid vlan 2	Set the switching characteristics of this interface to customer edge hybrid and allow VLAN 2
(config-if)#switchport customer-edge hybrid allowed vlan all	Set the switching characteristics of this interface to customer edge hybrid and allow VLAN all
(config-if)#mlag 3	Enabling mlag group number
(config-if)#commit	Commit candidate configuration to be running configuration
(config-if)#exit	Exit interface mode
(config)#interface xe49/1	Entering interface mode
(config-if)#switchport	Configuring interface as switchport
(config-if)#bridge-group 1	Associate the interface with bridge group 1.
(config-if)#switchport mode provider-network	Set the switching characteristics of this interface to provider network
(config-if)#switchport provider-network allowed vlan all	Set the switching characteristics of this interface to provider network and allow all VLAN
(config-if)#commit	Commit candidate configuration to be running configuration
(config-if)#exit	Enter interface mode
(config)#interface xe3	Entering interface mode
(config-if)#switchport	Configuring interface as switchport
(config-if)#bridge-group 1	Associate the interface with bridge group 1.
(config-if)#switchport mode customer-edge hybrid	Set the switching characteristics of this interface to customer edge hybrid
(config-if)#switchport customer-edge hybrid vlan 2	Set the switching characteristics of this interface to customer edge hybrid and allow vlan 2
(config-if)#switchport customer-edge hybrid allowed vlan all	Set the switching characteristics of this interface to customer edge hybrid and allow VLAN all
(config-if)#channel-group 1 mode active	Add this interface to channel group 1 and enable link aggregation so that it can be selected for aggregation by the local system
(config-if)#commit	Commit candidate configuration to be running configuration
(config-if)#exit	Exit interface mode
(config)#interface mlag3	Entering MLAG interface
(config-if)#bridge-group 1 spanning-tree disable	Associate the interface with bridge group 1 and disabling spanning-tree
(config-if)#switchport mode customer-edge hybrid	Set the switching characteristics of this interface to customer edge hybrid
(config-if)#switchport customer-edge hybrid vlan 2	Set the switching characteristics of this interface to customer edge hybrid and allow VLAN 2
(config-if)#switchport customer-edge hybrid allowed vlan all	Set the switching characteristics of this interface to customer edge hybrid and allow VLAN all
(config-if)#switchport customer-edge vlan registration map1	Configuring the registration table mapping on MLAG interface
(config-if)#switchport port-security	Enabling port security

## Port Security Configuration

(config-if) #switchport port-security maximum 10	Limiting the maximum mac to 10
(config-if) #commit	Commit candidate configuration to be running configuration
(config-if) #exit	Exit interface mode
(config) #mcec domain configuration	Entering MCEC mode
(config-mcec-domain) #domain-address 2222.2222.2222	Domain address for the MLAG domain
(config-mcec-domain) #domain-system-number 1	Number to identify the node in a domain
(config-if) #commit	Commit candidate configuration to be running configuration
(config-mcec-domain) #exit	Exit MCEC mode
(config) #intra-domain-link xe49/1	Intra domain line between MLAG domain
(config-if) #domain-priority 333	Domain priority for MCEC
(config-if) #commit	Commit candidate configuration to be running configuration

## TOR2

(config-if) #	
#configure terminal	Enter configure mode
(config) #bridge 1 protocol provider-rstp edge	Create provider RSTP bridge
(config) #vlan 2-10 type customer bridge 1 state enable	Enabling customer VLAN for bridge
(config) #vlan 2-10 type service point-point bridge 1 state enable	Enabling service VLAN for bridge
(config) #cvlan registration table map1 bridge 1	Creating registration table
(config-cvlan-registation) #cvlan 2 svlan 2	Mapping CVLAN to SVLAN
(config-cvlan-registation) #cvlan 10 svlan 2	Mapping CVLAN to SVLAN
(config-cvlan-registation) #commit	Commit candidate configuration to be running configuration
(config-cvlan-registation) #exit	Exit registration table mode
(config) #interface mlag3	Entering MLAG interface
(config-if) #switchport	Configuring interface as switchport
(config-if) #commit	Commit candidate configuration to be running configuration
(config-if) #exit	Exit interface mode
(config) #interface po1	Entering dynamic lag interface
(config-if) #Switchport	Configuring interface as switchport
(config-if) #bridge-group 1 spanning-tree disable	Associate the interface with bridge group 1 and disabling spanning-tree
(config-if) #switchport mode customer-edge hybrid	Set the switching characteristics of this interface to customer edge hybrid
(config-if) #switchport customer-edge hybrid vlan 2	Set the switching characteristics of this interface to customer edge hybrid and allow VLAN 2
(config-if) #switchport customer-edge hybrid allowed vlan all	Set the switching characteristics of this interface to customer edge hybrid and allow VLAN all
(config-if) #mlag 3	Enabling MLAG group number
(config-if) #commit	Commit candidate configuration to be running configuration

(config-if)#exit	Exit interface mode
(config)#interface xe49/1	Entering interface mode
(config-if)#switchport	Configuring interface as switchport
(config-if)#bridge-group 1	Associate the interface with bridge group 1.
(config-if)#switchport mode provider-network	Set the switching characteristics of this interface to provider network
(config-if)#switchport provider-network allowed vlan all	Set the switching characteristics of this interface to provider network and allow all VLAN
(config-if)#commit	Commit candidate configuration to be running configuration
(config-if)#exit	Exit interface mode
(config)#interface xe3	Entering interface mode
(config-if)#switchport	Configuring interface as switchport
bridge-group 1	Associate the interface with bridge group 1
(config-if)#switchport mode customer-edge hybrid	Set the switching characteristics of this interface to customer edge hybrid
(config-if)#switchport customer-edge hybrid vlan 2	Set the switching characteristics of this interface to customer edge hybrid and allow VLAN 2
(config-if)#switchport customer-edge hybrid allowed vlan all	Set the switching characteristics of this interface to customer edge hybrid and allow VLAN all
(config-if)#channel-group 1 mode active	Add this interface to channel group 1 and enable link aggregation so that it can be selected for aggregation by the local system
(config-if)#commit	Commit candidate configuration to be running configuration
(config-if)#exit	Exit interface mode
(config)#interface mlag3	Entering MLAG interface
(config-if)#bridge-group 1 spanning-tree disable	Associate the interface with bridge group 1 and disabling spanning-tree
(config-if)#switchport mode customer-edge hybrid	Set the switching characteristics of this interface to customer edge hybrid
(config-if)#switchport customer-edge hybrid vlan 2	Set the switching characteristics of this interface to customer edge hybrid and allow VLAN 2
(config-if)#switchport customer-edge hybrid allowed vlanall	Set the switching characteristics of this interface to customer edge hybrid and allow VLAN all
(config-if)#switchport customer-edge vlan registration map1	Configuring the registration table mapping on MLAG interface
(config-if)#commit	Commit candidate configuration to be running configuration
(config-if)#exit	Exit interface mode
mcec domain configuration	Entering MCEC mode
(config-mcec-domain)#domain-address 2222.2222.2222	Domain address for the MLAG domain
(config-mcec-domain)#domain-system-number 2	Number to identify the node in a domain
(config-mcec-domain)#intra-domain-link xe49/1	Intra domain line between MLAG domain
(config-mcec-domain)#domain-priority 333	Domain priority for MCEC
(config-mcec-domain)#commit	Commit candidate configuration to be running configuration

**SW1**

configure terminal	Enter configuration mode
(config)#bridge 1 protocol rstp vlan-bridge	Configuring the RSTP vlan bridge
(config)#interface po1	Entering interface mode
(config-if)#switchport	Configuring interface as switchport
(config-if)#bridge-group 1 spanning-tree disable	Associate the interface with bridge group 1and disabling spanning-tree
(config-if)#switchport mode hybrid	Set the switching characteristics of this interface hybrid
(config-if)#switchport hybrid allowed vlan all	Set the switching characteristics of this interface hybrid and allowing all vlan
(config-if)#commit	Commit candidate configuration to be running configuration
(config-if)#exit	Exit interface mode
(config)#interface xe1/3	Entering interface mode
(config-if)#switchport	Configuring interface as switchport
(config-if)#bridge-group 1 spanning-tree disable	Associate the interface with bridge group 1and disabling spanning-tree
(config-if)#switchport mode hybrid	Set the switching characteristics of this interface hybrid
(config-if)#switchport hybrid allowed vlan all	Set the switching characteristics of this interface hybrid and allowing all vlan
(config-if)#channel-group 1 mode active	Add this interface to channel group 1 and enable link aggregation so that it can be selected for aggregation by the local system.
(config-if)#commit	Commit candidate configuration to be running configuration
(config-if)#exit	Exit interface mode
(config)#interface xe1/1	Entering interface mode
(config-if)#switchport	Configuring interface as switchport
(config-if)#bridge-group 1 spanning-tree disable	Associate the interface with bridge group 1 and disabling spanning-tree
(config-if)#switchport mode hybrid	Set the switching characteristics of this interface hybrid
(config-if)#switchport hybrid allowed vlan all	Set the switching characteristics of this interface hybrid and allowing all vlan
(config-if)#channel-group 1 mode active	Add this interface to channel group 1 and enable link aggregation so that it can be selected for aggregation by the local system.
(config-if)#commit	Commit candidate configuration to be running configuration
(config-if)#exit	Exit interface mode
(config)#interface xe3/3	Entering interface mode
(config-if)#switchport	Configuring interface as switchport
(config-if)#bridge-group 1	Associate the interface with bridge group 1and disabling spanning-tree
(config-if)#switchport mode hybrid	Set the switching characteristics of this interface hybrid
(config-if)#switchport hybrid allowed vlan all	Set the switching characteristics of this interface hybrid and allowing all VLAN
(config-if)#commit	Commit candidate configuration to be running configuration



## Validation

TOR1#show bridge

Ageout time is global and if something is configured for vxlan then it will be affected here also

Bridge	CVLAN	SVLAN	BVLAN	Port	MAC Address	FWD	Time-out
1		2		mlag3	0000.0500.0200	1	54
1		2		mlag3	0000.0500.0201	1	60
1		2		mlag3	0000.0500.0202	1	54
1		2		mlag3	0000.0500.0203	1	60
1		2		mlag3	0000.0500.0204	1	54
1		2		mlag3	0000.0500.0205	1	60
1		2		mlag3	0000.0500.0207	1	60
1		2		mlag3	0000.0500.0208	1	54
1		2		mlag3	0000.0500.0209	1	60
1		2		mlag3	0000.0500.020a	1	54
1		2		mlag3	0000.0500.020b	1	60
1		2		mlag3	0000.0500.020c	1	54
1		2		mlag3	0000.0500.020d	1	60
1		2		mlag3	0000.0500.020e	1	54
1		2		mlag3	0000.0500.020f	1	60
1		2		mlag3	0000.0500.0210	1	54
1		2		mlag3	0000.0500.0211	1	60
1		2		mlag3	0000.0500.0212	1	54
1		2		mlag3	cc37.abbb.ed9b	1	40

TOR1#sh port-security

Port	port-security mode	MAC limit	CVLAN	SVLAN	static	secure	MAC
Mlag3	dynamic	10					

TOR1#

TOR1#show mac address-table count bridge 1 interface mlag3

MAC Entries for all vlans:

Dynamic Address Count: 20

Static (User-defined) Unicast MAC Address Count: 0

Static (User-defined) Multicast MAC Address Count: 0

Total MAC Addresses in Use: 20

TOR1#



## CHAPTER 11 Traffic Segmentation-Protected Port

The protected port is a feature that does not forward any traffic (unicast, multicast, or broadcast) to any other port that is also a protected port. However, a protected port can communicate with an unprotected port and vice-versa.

The protected port is a feature that does not forward any traffic (unicast, multicast, or broadcast) to any other port that is also a protected port. However, a protected port can communicate with an unprotected port and vice-versa.

- Protected port(isolated) to protected port(isolated) - communication is not allowed.
- Protected port(isolated) to protected port(community) - communication is not allowed.
- Protected port(isolated) to protected port(promiscuous) - communication is allowed.
- Protected port(community) to protected port(community) - communication is allowed.
- Protected port(community) to protected port(promiscuous) - communication is allowed.
- Protected port(promiscuous) to protected port(promiscuous) - communication is allowed.
- Unprotected port to protected port(any type) - communication is allowed.

The protected port configuration is local to the switch. This information is not propagated outside the switch. Protected ports across switches can still be able to communicate with each other.

The use of protected ports ensures that there is no exchange of unicast, broadcast, or multicast data traffic between ports on the same switch so that one neighbor does not see the traffic generated by another neighbor.

### Topology

Figure 11-25 displays Traffic Segmentation-Protected Port Topology

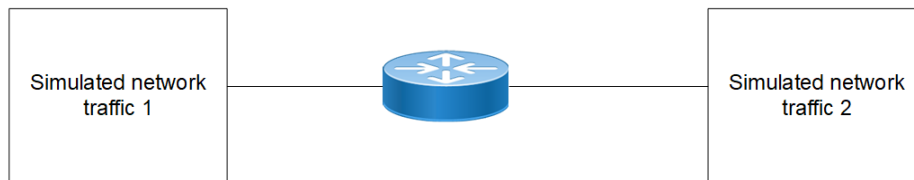

Figure 11-25: Traffic Segmentation-Protected Port Topology

### Isolated-Promiscuous Configuration

#### RTR1

Bridge Configuration:

#configure terminal	Enter configure mode.
(config)#bridge 1 protocol ieee vlan-bridge	Configure bridge
(config)#commit	Commit candidate configuration to be running configuration

VLAN Configuration:

#configure terminal	Enter configterminal mode
(config)#vlan database	Enter into the vlan database
(config-vlan)# vlan 30 bridge 1 state enable	Configure vlan 30 to bridge 1
(config-vlan)#commit	Commit candidate configuration to be running configuration
(config-vlan)#exit	Exit from the vlan database.
(config)#int xe1	Enter interface configuration mode for xe1
(config-if)#switchport	Configure switchport
(config-if)#bridge-group 1	Associate interface with bridge-group 1
(config-if)#switchport mode trunk	Set the switching characteristics of this interface as trunk
(config-if)#switchport trunk allowed vlan add 30	Configure vlan 30
(config-if)#switchport protected isolated	Configure interface as isolated port
(config-if)#commit	Commit candidate configuration to be running configuration
(config-if)#exit	Exit from interface
(config)#int xe2	Enter interface configuration mode for xe2
(config-if)#switchport	Configure switchport
(config-if)#bridge-group 1	Associate interface with bridge-group 1
(config-if)#switchport mode trunk	Set the switching characteristics of this interface as trunk
(config-if)#switchport trunk allowed vlan add 30	Configure vlan 30
(config-if)#switchport protected promiscuous	Configure interface as promiscuous port
(config-if)#exit	Exit from interface mode
(config)#commit	Commit the configure on the node.

---

## Validation

### RTR1

```
#show running-config interface xe1
!
interface xe1
switchport
    switchport protected isolated
    bridge-group 1
    switchport mode trunk
    switchport trunk allowed vlan add 30
!
#show running-config interface xe2
!
interface xe2
switchport
switchport protected promiscuous
bridge-group 1
```

---

```
switchport mode trunk
switchport trunk allowed vlan add 30
```

```
#show interface xe1
```

```
Interface xe1
```

```
Flexport: Non Control Port (Active)
Hardware is ETH Current HW addr: 80a2.353f.edb7
Physical:80a2.353f.edb7 Logical:(not set)
Forward Error Correction (FEC) configured is Auto (default)
FEC status is N/A
Port Mode is trunk
Protected Mode is Isolated
Interface index: 5001
Metric 1 mtu 1500 duplex-full link-speed 10g
Debounce timer: disable
<UP,BROADCAST,RUNNING,MULTICAST>
VRF Binding: Not bound
Label switching is disabled
No Virtual Circuit configured
Administrative Group(s): None
Bandwidth 10g
DHCP client is disabled.
Last Flapped: 2022 Jan 06 13:13:42 (00:24:53 ago)
Statistics last cleared: 2022 Jan 06 13:13:42 (00:24:53 ago)
5 minute input rate 0 bits/sec, 0 packets/sec
5 minute output rate 256 bits/sec, 0 packets/sec
RX
  unicast packets 0 multicast packets 7 broadcast packets 0
  input packets 7 bytes 814
  jumbo packets 0
  undersize 0 oversize 0 CRC 0 fragments 0 jabbers 0
  input error 0
  input with dribble 0 input discard 7
  Rx pause 0
TX
  unicast packets 0 multicast packets 749 broadcast packets 0
  output packets 749 bytes 47944
  jumbo packets 0
  output errors 0 collision 0 deferred 0 late collision 0
  output discard 0
  Tx pause 0
```

```
#show interface xe2
```

```
Interface xe2
```

```
Flexport: Non Control Port (Active)
Hardware is ETH Current HW addr: 80a2.353f.edb9
Physical:80a2.353f.edb9 Logical:(not set)
Forward Error Correction (FEC) configured is Auto (default)
FEC status is N/A
Port Mode is trunk
```

## Traffic Segmentation-Protected Port

---

```
Protected Mode is Promiscuous
Interface index: 5003
Metric 1 mtu 1500 duplex-full link-speed 10g
Debounce timer: disable
<UP,BROADCAST,RUNNING,MULTICAST>
VRF Binding: Not bound
Label switching is disabled
No Virtual Circuit configured
Administrative Group(s): None
Bandwidth 10g
DHCP client is disabled.
Last Flapped: Never
Statistics last cleared: 2022 Jan 06 13:15:32 (00:23:52 ago)
5 minute input rate 0 bits/sec, 0 packets/sec
5 minute output rate 0 bits/sec, 0 packets/sec
```

```
RX
  unicast packets 0 multicast packets 0 broadcast packets 0
  input packets 0 bytes 0
  jumbo packets 0
  undersize 0 oversize 0 CRC 0 fragments 0 jabbers 0
  input error 0
  input with dribble 0 input discard 0
  Rx pause 0
```

```
TX
  unicast packets 0 multicast packets 4569 broadcast packets 0
  input packets 4569 bytes 327802
  jumbo packets 0
  output errors 0 collision 0 deferred 0 late collision 0
  output discard 0
  Tx pause 0
```

```
Send the vlan 30 tagged traffic from traffic 1 to traffic 2,
#show interface counters rate mbps
```

```
+-----+-----+-----+-----+-----+
| Interface|Rx mbps|Rx pps|Tx mbps|Tx pps|
+-----+-----+-----+-----+-----+
|   Xe1    | 100.01|   20 |   0.00|    0 |
|   Xe2    |   0.00|    0 | 100.01|   20 |
```

```
Send the vlan 30 tagged traffic from traffic 1 to traffic 2,
#show interface counters rate mbps
```

```
+-----+-----+-----+-----+-----+
| Interface|Rx mbps|Rx pps|Tx mbps|Tx pps|
+-----+-----+-----+-----+-----+
|   Xe1    |   0.00|   20 | 100.00|    0 |
|   Xe2    | 100.00|    0 |   0.00|   20 |
```

---

## Isolated-Isolated Configuration

### RTR1

#### Bridge Configuration:

#configure terminal	Enter configure mode.
(config-if)#commit	Commit candidate configuration to be running configuration
(config-if)#bridge 1 protocol ieee vlan-bridge	Configure bridge

#### VLAN Configuration:

#configure terminal	Enter configterminal mode
(config)#vlan database	Enter into the vlan database
(config-vlan)# vlan 30 bridge 1 state enable	Configure vlan 30 to bridge 1
(config-vlan)#commit	Commit candidate configuration to be running configuration
(config-vlan)#exit	Exit from the vlan database.
(config)#int xe1	Enter interface configuration mode for xe1
(config-if)#switchport	Configure switchport
(config-if)#bridge-group 1	Associate interface with bridge-group 1
(config-if)#switchport mode trunk	Set the switching characteristics of this interface as trunk
(config-if)#switchport trunk allowed vlan add 30	Configure vlan 30
(config-if)#switchport protected isolated	Configure interface as isolated port
(config-if)#commit	Commit candidate configuration to be running configuration
(config-if)#exit	Exit from interface
(config)#int xe2	Enter interface configuration mode for xe2
(config-if)#switchport	Configure switchport
(config-if)#bridge-group 1	Associate interface with bridge-group 1
(config-if)#switchport mode trunk	Set the switching characteristics of this interface as trunk
(config-if)#switchport trunk allowed vlan add 30	Configure vlan 30
(config-if)#switchport protected isolated	Configure interface as isolated port
(config-if)#exit	Exit from interface mode
(config)#commit	Commit the configure on the node.

---

## Validation

### RTR1

```
#show running-config interface xe1
!
```

```
interface xe1
switchport
    switchport protected isolated
    bridge-group 1
    switchport mode trunk
    switchport trunk allowed vlan add 30
!
#show running-config interface xe2
!
interface xe2
switchport
switchport protected isolated
bridge-group 1
switchport mode trunk
switchport trunk allowed vlan add 30

#show interface xe1
Interface xe1
Flexport: Non Control Port (Active)
Hardware is ETH Current HW addr: 80a2.353f.edb7
Physical:80a2.353f.edb7 Logical:(not set)
Forward Error Correction (FEC) configured is Auto (default)
FEC status is N/A
Port Mode is trunk
Protected Mode is Isolated
Interface index: 5001
Metric 1 mtu 1500 duplex-full link-speed 10g
Debounce timer: disable
<UP,BROADCAST,RUNNING,MULTICAST>
VRF Binding: Not bound
Label switching is disabled
No Virtual Circuit configured
Administrative Group(s): None
Bandwidth 10g
DHCP client is disabled.
Last Flapped: 2022 Jan 06 13:13:42 (00:24:53 ago)
Statistics last cleared: 2022 Jan 06 13:13:42 (00:24:53 ago)
5 minute input rate 0 bits/sec, 0 packets/sec
5 minute output rate 256 bits/sec, 0 packets/sec
RX
    unicast packets 0 multicast packets 7 broadcast packets 0
    input packets 7 bytes 814
    jumbo packets 0
    undersize 0 oversize 0 CRC 0 fragments 0 jabbers 0
    input error 0
    input with dribble 0 input discard 7
    Rx pause 0
TX
    unicast packets 0 multicast packets 749 broadcast packets 0
    output packets 749 bytes 47944
```



jumbo packets 0
output errors 0 collision 0 deferred 0 late collision 0
output discard 0
Tx pause 0

#show interface xe2

Interface xe2

Flexport: Non Control Port (Active)
Hardware is ETH Current HW addr: 80a2.353f.edb9
Physical:80a2.353f.edb9 Logical:(not set)
Forward Error Correction (FEC) configured is Auto (default)
FEC status is N/A
Port Mode is trunk
Protected Mode is Isolated
Interface index: 5003
Metric 1 mtu 1500 duplex-full link-speed 10g
Debounce timer: disable
<UP,BROADCAST,RUNNING,MULTICAST>
VRF Binding: Not bound
Label switching is disabled
No Virtual Circuit configured
Administrative Group(s): None
Bandwidth 10g
DHCP client is disabled.
Last Flapped: Never
Statistics last cleared: 2022 Jan 06 13:15:32 (00:23:52 ago)
5 minute input rate 0 bits/sec, 0 packets/sec
5 minute output rate 0 bits/sec, 0 packets/sec

RX
unicast packets 0 multicast packets 0 broadcast packets 0
input packets 0 bytes 0
jumbo packets 0
undersize 0 oversize 0 CRC 0 fragments 0 jabbers 0
input error 0
input with dribble 0 input discard 0
Rx pause 0

TX
unicast packets 0 multicast packets 0 broadcast packets 0
output packets 0 bytes 0
jumbo packets 0
output errors 0 collision 0 deferred 0 late collision 0
output discard 0
Tx pause 0

Send the vlan 30 tagged traffic from traffic 1 to traffic 2,

#show interface counters rate mbps

Table with 5 columns: Interface, Rx mbps, Rx pps, Tx mbps, Tx pps. Row 1: Xe1, 100.01, 20, 0.00, 0

## Traffic Segmentation-Protected Port

---

xe2	0.00	0	0.00	0
-----	------	---	------	---

## CHAPTER 12 RPVST+ Configuration

This chapter contains a complete example of an RPVST+ configuration.

### Topology



Figure 12-26: RPVST+ configuration

### Configuration

#### Switch 2

#configure terminal	Enter configure mode for the switch.
(config)#bridge 1 protocol rpvst+	Configure bridge 1 as an RPVST+ bridge.
(config)#vlan 2-3 bridge 1	Configure VLAN 2 and 3 and associate it to bridge 1.
(config)#spanning-tree rpvst+ configuration	Enter Rapid Per-VLAN Spanning Tree configuration mode.
(config-rpvst+)#bridge 1 vlan 2	Associate a configured VLAN with bridge 1.
(config-rpvst+)#bridge 1 vlan 3	Associate a configured VLAN with bridge 1,.
(config-rvpst+)#exit	Exit RPVST+ configuration mode.
(config)#interface eth1	Enter interface mode for eth1.
(config-if)#switchport	Configure eth1 as a Layer 2 port.
(config-if)#bridge-group 1	Associate bridge to interface.
(config-if)#switchport mode trunk	Configure port as trunk.
(config-if)#switchport trunk allowed vlan add 2,3	Configure VLAN 2 and VLAN 3 on interface.
(config-if)#bridge-group 1 vlan 2	Configure bridge group to interface with VLAN 2.
(config-if)#bridge-group 1 vlan 3	Configure bridge group to interface with VLAN 3.
(config-if)#exit	Exit interface mode.
(config)#interface eth2	Enter interface mode for eth2.
(config-if)#switchport	Configure eth2 as a Layer 2 port.
(config-if)#bridge-group 1	Associate bridge to interface/
(config-if)#switchport mode trunk	Configure port as trunk
(config-if)#switchport trunk allowed vlan add 2,3	Configure VLAN 2 and VLAN 3 on interface.
(config-if)#bridge-group 1 vlan 2	Configure bridge group to interface with VLAN 2.
(config-if)#bridge-group 1 vlan 3	Configure bridge group to interface with VLAN3.
(config-if)#exit	Exit interface mode.

### Switch 1

#configure terminal	Enter configure mode for the switch.
(config)#bridge 1 protocol rpvst+	Configure bridge 1 as an rpvst+ bridge.
(config)#vlan 2-3 bridge 1	Configure VLAN 2 and 3 and associate it to bridge 1.
(config)#spanning-tree rpvst+ configuration	Enter Rapid Per-VLAN Spanning Tree configuration mode.
(config-rpvst+)#bridge 1 vlan 2	Associate a configured VLAN with bridge 1.
(config-rpvst+)#bridge 1 vlan 3	Associate a configured VLAN with bridge 1.
(config-rvpst+)#exit	Exit RPVST+ configuration mode.
(config)#interface eth1	Enter interface mode for eth1.
(config-if)#switchport	Configure eth1 as a Layer 2 port.
(config-if)#bridge-group 1	Associate bridge to interface.
(config-if)#switchport mode trunk	Configure port as trunk.
(config-if)#switchport trunk allowed vlan add 2,3	Configure VLAN 2 and VLAN 3 on interface.
(config-if)#bridge-group 1 vlan 2	Configure bridge group to interface with VLAN 2.
(config-if)#bridge-group 1 vlan 3	Configure bridge group to interface with VLAN3.
(config-if)#exit	Exit interface mode.

### Switch 3

#configure terminal	Enter configure mode for the switch.
(config)#bridge 1 protocol rpvst+	Configure bridge 1 as an rpvst+ bridge
(config)#vlan 2-3 bridge 1	Configure VLAN 2 and 3 and associate it to bridge 1.
(config)#interface eth1	Enter interface mode for eth1.
(config-if)#switchport	Configure eth1 as a Layer 2 port.
(config-if)#bridge-group 1	Associate bridge to interface.
(config-if)#switchport mode trunk	Configure port as trunk.
(config-if)#switchport trunk allowed vlan add 2,3	Configure VLAN 2 and VLAN 3 on interface.
(config-if)#exit	Exit interface mode.

## Validation

### Switch2

```
#show spanning-tree rpvst+ vlan 2
% vlan 2 Instance 1 configured
% 1: Root Path Cost 0 - Root Port 0 - Bridge Priority 32768
% 1: Root Id 8002525400b7bfa7
% 1: Bridge Id 8002525400b7bfa7
% eth1: Port Number 3 - Ifindex 3 - Port Id 0x8003 - Role Designated - State Forwarding
```

```
% eth1: Designated Internal Path Cost 0 - Designated Port Id 0x8003
% eth1: Configured Internal Path Cost 200000
% eth1: Configured External Path cost 200000
% eth1: Configured Internal Priority 128
% eth1: Configured External Priority 128
% eth1: Designated Root 8002525400b7bfa7
% eth1: Designated Bridge 8002525400b7bfa7
% eth1: Message Age 0 - Max Age 20
% eth1: Hello Time 2 - Forward Delay 15
% eth1: Forward Timer 0 - Msg Age Timer 0 - Hello Timer 0
%
% eth2: Port Number 4 - Ifindex 4 - Port Id 0x8004 - Role Designated - State
Forwarding
% eth2: Designated Internal Path Cost 0 - Designated Port Id 0x8004
% eth2: Configured Internal Path Cost 200000
% eth2: Configured External Path cost 200000
% eth2: Configured Internal Priority 128
% eth2: Configured External Priority 128
% eth2: Designated Root 8002525400b7bfa7
% eth2: Designated Bridge 8002525400b7bfa7
% eth2: Message Age 0 - Max Age 20
% eth2: Hello Time 2 - Forward Delay 15
% eth2: Forward Timer 0 - Msg Age Timer 0 - Hello Timer 1
%

#show spanning-tree rpvst+ interface eth1
% 1: Bridge up - Spanning Tree Enabled - topology change detected
% 1: Root Path Cost 0 - Root Port 0 - Bridge Priority 32768
% 1: Forward Delay 15 - Hello Time 2 - Max Age 20 - Transmit Hold Count 6
% 1: Root Id 8001525400b7bfa7
% 1: Bridge Id 8001525400b7bfa7
% 1: last topology change Wed Mar 28 15:33:06 2018
% 1: 2 topology change(s) - last topology change Wed Mar 28 15:33:06 2018

% 1: portfast bpdu-filter disabled
% 1: portfast bpdu-guard disabled
% 1: portfast errdisable timeout disabled
% 1: portfast errdisable timeout interval 300 sec
% eth1: Port Number 3 - Ifindex 3 - Port Id 0x8003 - Role Designated - State
Forwarding
% eth1: Designated External Path Cost 0 -Internal Path Cost 0
% eth1: Configured Path Cost 200000 - Add type Explicit ref count 3
% eth1: Designated Port Id 0x8003 - Priority 128 -
% eth1: Root 8001525400b7bfa7
% eth1: Designated Bridge 8001525400b7bfa7
% eth1: Message Age 0 - Max Age 20
% eth1: Hello Time 2 - Forward Delay 15
% eth1: Forward Timer 0 - Msg Age Timer 0 - Hello Timer 2 - topo change timer 0
% eth1: forward-transitions 1
% eth1: Version Rapid Spanning Tree Protocol - Received None - Send RSTP
% eth1: No portfast configured - Current portfast off
```

## RPVST+ Configuration

---

```
% eth1: bpdu-guard default - Current bpdu-guard off
% eth1: bpdu-filter default - Current bpdu-filter off
% eth1: no root guard configured - Current root guard off
% eth1: Configured Link Type point-to-point - Current point-to-point
% eth1: No auto-edge configured - Current port Auto Edge off
%
%
% Instance          VLAN
% 0:                1
% 1:                2
% 2:                3

#show spanning-tree rpvst+ detail
% 1: Bridge up - Spanning Tree Enabled - topology change detected
% 1: Root Path Cost 0 - Root Port 0 - Bridge Priority 32768
% 1: Forward Delay 15 - Hello Time 2 - Max Age 20 - Transmit Hold Count 6
% 1: Root Id 8001525400b7bfa7
% 1: Bridge Id 8001525400b7bfa7
% 1: last topology change Wed Mar 28 15:33:06 2018
% 1: 2 topology change(s) - last topology change Wed Mar 28 15:33:06 2018

% 1: portfast bpdu-filter disabled
% 1: portfast bpdu-guard disabled
% 1: portfast errdisable timeout disabled
% 1: portfast errdisable timeout interval 300 sec
% eth1: Port Number 3 - Ifindex 3 - Port Id 0x8003 - Role Designated - State Forwarding
% eth1: Designated External Path Cost 0 -Internal Path Cost 0
% eth1: Configured Path Cost 200000 - Add type Explicit ref count 3
% eth1: Designated Port Id 0x8003 - Priority 128 -
% eth1: Root 8001525400b7bfa7
% eth1: Designated Bridge 8001525400b7bfa7
% eth1: Message Age 0 - Max Age 20
% eth1: Hello Time 2 - Forward Delay 15
% eth1: Forward Timer 0 - Msg Age Timer 0 - Hello Timer 0 - topo change timer 0
% eth1: forward-transitions 1
% eth1: Version Rapid Spanning Tree Protocol - Received None - Send RSTP
% eth1: No portfast configured - Current portfast off
% eth1: bpdu-guard default - Current bpdu-guard off
% eth1: bpdu-filter default - Current bpdu-filter off
% eth1: no root guard configured - Current root guard off
% eth1: Configured Link Type point-to-point - Current point-to-point
% eth1: No auto-edge configured - Current port Auto Edge off
%
% eth2: Port Number 4 - Ifindex 4 - Port Id 0x8004 - Role Designated - State Forwarding
% eth2: Designated External Path Cost 0 -Internal Path Cost 0
% eth2: Configured Path Cost 200000 - Add type Explicit ref count 3
% eth2: Designated Port Id 0x8004 - Priority 128 -
```

---

```
% eth2: Root 8001525400b7bfa7
% eth2: Designated Bridge 8001525400b7bfa7
% eth2: Message Age 0 - Max Age 20
% eth2: Hello Time 2 - Forward Delay 15
% eth2: Forward Timer 0 - Msg Age Timer 0 - Hello Timer 1 - topo change timer 0
% eth2: forward-transitions 1
% eth2: Version Rapid Spanning Tree Protocol - Received None - Send RSTP
% eth2: No portfast configured - Current portfast off
% eth2: bpdu-guard default - Current bpdu-guard off
% eth2: bpdu-filter default - Current bpdu-filter off
% eth2: no root guard configured - Current root guard off
% eth2: Configured Link Type point-to-point - Current point-to-point
% eth2: No auto-edge configured - Current port Auto Edge off
%
```

```
% Instance 1: Vlans: 2
% eth1: Port Number 3 - Ifindex 3 - Port Id 0x8003 - Role Designated - State
Forwarding
% eth1: Designated Internal Path Cost 0 - Designated Port Id 0x8003
% eth1: Configured Internal Path Cost 200000
% eth1: Configured External Path cost 200000
% eth1: Configured Internal Priority 128
% eth1: Configured External Priority 128
% eth1: Designated Root 8002525400b7bfa7
% eth1: Designated Bridge 8002525400b7bfa7
% eth1: Message Age 0 - Max Age 20
% eth1: Hello Time 2 - Forward Delay 15
% eth1: Forward Timer 0 - Msg Age Timer 0 - Hello Timer 0
```

```
% Instance 1: Vlans: 2
% eth2: Port Number 4 - Ifindex 4 - Port Id 0x8004 - Role Designated - State
Forwarding
% eth2: Designated Internal Path Cost 0 - Designated Port Id 0x8004
% eth2: Configured Internal Path Cost 200000
% eth2: Configured External Path cost 200000
% eth2: Configured Internal Priority 128
% eth2: Configured External Priority 128
% eth2: Designated Root 8002525400b7bfa7
% eth2: Designated Bridge 8002525400b7bfa7
% eth2: Message Age 0 - Max Age 20
% eth2: Hello Time 2 - Forward Delay 15
% eth2: Forward Timer 0 - Msg Age Timer 0 - Hello Timer 1
```

```
% Instance 2: Vlans: 3
% eth1: Port Number 3 - Ifindex 3 - Port Id 0x8003 - Role Designated - State
Forwarding
% eth1: Designated Internal Path Cost 0 - Designated Port Id 0x8003
% eth1: Configured Internal Path Cost 200000
% eth1: Configured External Path cost 200000
```

## RPVST+ Configuration

---

```
% eth1: Configured Internal Priority 128
% eth1: Configured External Priority 128
% eth1: Designated Root 8003525400b7bfa7
% eth1: Designated Bridge 8003525400b7bfa7
% eth1: Message Age 0 - Max Age 20
% eth1: Hello Time 2 - Forward Delay 15
% eth1: Forward Timer 0 - Msg Age Timer 0 - Hello Timer 0

% Instance 2: Vlans: 3
% eth2: Port Number 4 - Ifindex 4 - Port Id 0x8004 - Role Designated - State
Forwarding
% eth2: Designated Internal Path Cost 0 - Designated Port Id 0x8004
% eth2: Configured Internal Path Cost 200000
% eth2: Configured External Path cost 200000
% eth2: Configured Internal Priority 128
% eth2: Configured External Priority 128
% eth2: Designated Root 8003525400b7bfa7
% eth2: Designated Bridge 8003525400b7bfa7
% eth2: Message Age 0 - Max Age 20
% eth2: Hello Time 2 - Forward Delay 15
% eth2: Forward Timer 0 - Msg Age Timer 0 - Hello Timer 1
```



## CHAPTER 13 RSTP Configuration

This chapter contains a complete sample Rapid Spanning Tree Protocol (RSTP) configuration. RSTP provides rapid convergence of a spanning tree. It speeds up the reconfiguration of the tree after a change by using alternate ports.

### Topology

The following example is a simple multi-bridge topology.

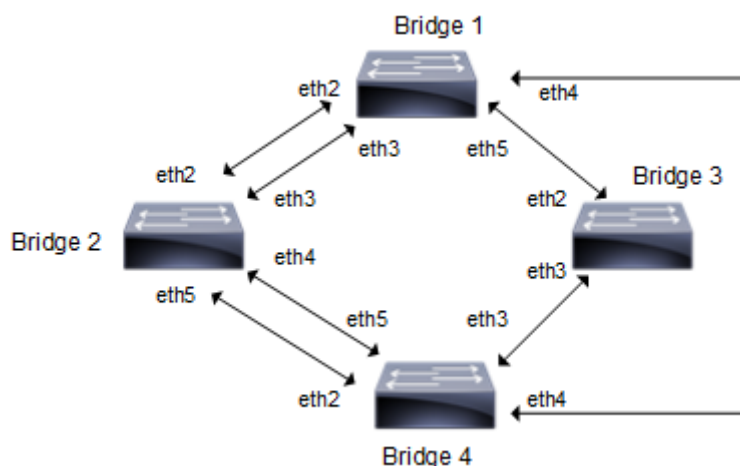

Figure 13-27: RSTP Topology

Note: Run the `switchport` command on each port to change to Layer-2 mode.

## Configuration

### Bridge 1

<code>Bridgel#configure terminal</code>	Enter configure mode.
<code>Bridgel(config)#bridge 1 protocol rstp</code>	Add a bridge (1) to the rapid spanning tree table
<code>Bridgel(config)#interface eth2</code>	Enter interface mode.
<code>Bridgel(config-if)#switchport</code>	Configure interface as a layer 2 port.
<code>Bridgel(config-if)#bridge-group 1</code>	Associate the interface with bridge group 1.
<code>Bridgel(config-if)#commit</code>	Commit the transaction.
<code>Bridgel(config-if)#exit</code>	Exit interface mode.
<code>Bridgel(config)#interface eth3</code>	Enter interface mode.
<code>Bridgel(config-if)#switchport</code>	Configure interface as a layer 2 port.
<code>Bridgel(config-if)#bridge-group 1</code>	Associate the interface with bridge group 1.
<code>Bridgel(config-if)#commit</code>	Commit the transaction.
<code>Bridgel(config-if)#exit</code>	Exit interface mode.
<code>Bridgel(config)#interface eth4</code>	Enter interface mode.
<code>Bridgel(config-if)#switchport</code>	Configure interface as a layer 2 port.

## RSTP Configuration

---

Bridge1 (config-if) #bridge-group 1	Associate the interface with bridge group 1.
Bridge1 (config-if) #commit	Commit the transaction.
Bridge1 (config-if) #exit	Exit interface mode.
Bridge1 (config) #interface eth5	Enter interface mode
Bridge1 (config-if) #switchport	Configure interface as a layer 2 port.
Bridge1 (config-if) #bridge-group 1	Associate the interface with bridge group 1.
Bridge1 (config-if) #commit	Commit the transaction.
Bridge1 (config-if) #exit	Exit interface mode.

---

### Bridge 2

Bridge2#configure terminal	Enter configure mode.
Bridge2 (config) #bridge 2 protocol rstp	Add a bridge (2) to the rapid spanning tree table
Bridge2 (config) #interface eth2	Enter interface mode.
Bridge2 (config-if) #switchport	Configure interface as a layer 2 port.
Bridge2 (config-if) #bridge-group 2	Associate the interface with bridge group 2.
Bridge2 (config-if) #commit	Commit the transaction.
Bridge2 (config-if) #exit	Exit interface mode.
Bridge2 (config) #interface eth3	Enter interface mode.
Bridge2 (config-if) #switchport	Configure interface as a layer 2 port.
Bridge2 (config-if) #bridge-group 2	Associate the interface with bridge group 2.
Bridge2 (config-if) #commit	Commit the transaction.
Bridge2 (config-if) #exit	Exit interface mode.
Bridge2 (config) #interface eth4	Enter interface mode.
Bridge2 (config-if) #switchport	Configure interface as a layer 2 port.
Bridge2 (config-if) #bridge-group 2	Associate the interface with bridge group 2.
Bridge2 (config-if) #commit	Commit the transaction.
Bridge2 (config-if) #exit	Exit interface mode.
Bridge2 (config) #interface eth5	Enter interface mode
Bridge2 (config-if) #switchport	Configure interface as a layer 2 port.
Bridge2 (config-if) #bridge-group 2	Associate the interface with bridge group 2.
Bridge2 (config-if) #commit	Commit the transaction.
Bridge2 (config-if) #exit	Exit interface mode.

---

### Bridge 3

Bridge3#configure terminal	Enter configure mode.
Bridge3 (config) #bridge 3 protocol rstp	Add a bridge (3) to the rapid spanning tree table
Bridge3 (config) #interface eth2	Enter interface mode.
Bridge3 (config-if) #switchport	Configure interface as a layer 2 port.
Bridge3 (config-if) #bridge-group 3	Associate the interface with bridge group 3.
Bridge3 (config-if) #commit	Commit the transaction.

---

---

Bridge3(config-if)#exit	Exit interface mode.
Bridge3(config-if)#switchport	Configure interface as a layer 2 port.
Bridge3(config)#interface eth3	Enter interface mode.
Bridge3(config-if)#bridge-group 3	Associate the interface with bridge group 3.
Bridge3(config-if)#commit	Commit the transaction.
Bridge3(config-if)#exit	Exit interface mode.

---

## Bridge 4

Bridge4#configure terminal	Enter configure mode.
Bridge4(config)#bridge 4 protocol rstp	Add a bridge (4) to the rapid spanning tree table
Bridge4(config)#interface eth2	Enter interface mode.
Bridge4(config-if)#switchport	Configure interface as a layer 2 port.
Bridge4(config-if)#bridge-group 4	Associate the interface with bridge group 4.
Bridge4(config-if)#commit	Commit the transaction.
Bridge4(config-if)#exit	Exit interface mode.
Bridge4(config)#interface eth3	Enter interface mode.
Bridge4(config-if)#switchport	Configure interface as a layer 2 port.
Bridge4(config-if)#bridge-group 4	Associate the interface with bridge group 4.
Bridge4(config-if)#commit	Commit the transaction.
Bridge4(config-if)#exit	Exit interface mode.
Bridge4(config)#interface eth4	Enter interface mode.
Bridge4(config-if)#switchport	Configure interface as a layer 2 port.
Bridge4(config-if)#bridge-group 4	Associate the interface with bridge group 4.
Bridge4(config-if)#commit	Commit the transaction.
Bridge4(config-if)#exit	Exit interface mode.
Bridge4(config)#interface eth5	Enter interface mode
Bridge4(config-if)#switchport	Configure interface as a layer 2 port.
Bridge4(config-if)#bridge-group 4	Associate the interface with bridge group 4.
Bridge4(config-if)#commit	Commit the transaction.
Bridge3(config-if)#exit	

---

## Validation

show spanning-tree, show spanning-tree interface <if-name>

### Bridge 1

```
#show spanning-tree
% 1: Bridge up - Spanning Tree Enabled - topology change detected
% 1: Root Path Cost 200000 - Root Port 6 - Bridge Priority 32768
% 1: Forward Delay 15 - Hello Time 2 - Max Age 20 - Transmit Hold Count 6
% 1: Root Id 800052540046f549
% 1: Bridge Id 80005254009cb7e6
% 1: last topology change Tue Aug 11 02:25:01 2020
```

---

## RSTP Configuration

---

```
% 1: 30 topology change(s) - last topology change Tue Aug 11 02:25:01 2020

% 1: portfast bpdu-filter disabled
% 1: portfast bpdu-guard disabled
% eth2: Port Number 4 - Ifindex 4 - Port Id 0x8004 - Role Alternate - State
Discarding
% eth2: Designated Path Cost 200000
% eth2: Configured Path Cost 200000 - Add type Explicit ref count 1
% eth2: Designated Port Id 0x8004 - Priority 128 -
% eth2: Root 800052540046f549
% eth2: Designated Bridge 8000525400751db5
% eth2: Message Age 1 - Max Age 20
% eth2: Hello Time 2 - Forward Delay 15
% eth2: Forward Timer 0 - Msg Age Timer 4 - Hello Timer 0 - topo change
timer 0
% eth2: forward-transitions 2
% eth2: Restricted-role OFF
% eth2: Version Rapid Spanning Tree Protocol - Receive RSTP - Send RSTP
% eth2: No portfast configured - Current portfast off
% eth2: bpdu-guard default - Current bpdu-guard off
% eth2: bpdu-filter default - Current bpdu-filter off
% eth2: no root guard configured - Current root guard off
% eth2: Configured Link Type point-to-point - Current point-to-point
% eth2: No auto-edge configured - Current port Auto Edge off
%
% eth3: Port Number 5 - Ifindex 5 - Port Id 0x8005 - Role Alternate - State
Discarding
% eth3: Designated Path Cost 200000
% eth3: Configured Path Cost 200000 - Add type Explicit ref count 1
% eth3: Designated Port Id 0x8005 - Priority 128 -
% eth3: Root 800052540046f549
% eth3: Designated Bridge 8000525400751db5
% eth3: Message Age 1 - Max Age 20
% eth3: Hello Time 2 - Forward Delay 15
% eth3: Forward Timer 0 - Msg Age Timer 3 - Hello Timer 0 - topo change
timer 0
% eth3: forward-transitions 3
% eth3: Restricted-role OFF
% eth3: Version Rapid Spanning Tree Protocol - Receive RSTP - Send RSTP
% eth3: No portfast configured - Current portfast off
% eth3: bpdu-guard default - Current bpdu-guard off
% eth3: bpdu-filter default - Current bpdu-filter off
% eth3: no root guard configured - Current root guard off
% eth3: Configured Link Type point-to-point - Current point-to-point
% eth3: No auto-edge configured - Current port Auto Edge off
%
% eth4: Port Number 6 - Ifindex 6 - Port Id 0x8006 - Role Rootport - State
Forwarding
% eth4: Designated Path Cost 0
% eth4: Configured Path Cost 200000 - Add type Explicit ref count 1
% eth4: Designated Port Id 0x8006 - Priority 128 -
% eth4: Root 800052540046f549
% eth4: Designated Bridge 800052540046f549
% eth4: Message Age 0 - Max Age 20
% eth4: Hello Time 2 - Forward Delay 15
% eth4: Forward Timer 0 - Msg Age Timer 3 - Hello Timer 0 - topo change
timer 0
% eth4: forward-transitions 6
```

```

% eth4: Restricted-role OFF
% eth4: Version Rapid Spanning Tree Protocol - Receive RSTP - Send RSTP
% eth4: No portfast configured - Current portfast off
% eth4: bpdu-guard default - Current bpdu-guard off
% eth4: bpdu-filter default - Current bpdu-filter off
% eth4: no root guard configured - Current root guard off
% eth4: Configured Link Type point-to-point - Current point-to-point
% eth4: No auto-edge configured - Current port Auto Edge off
%
% eth5: Port Number 7 - Ifindex 7 - Port Id 0x8007 - Role Alternate - State
Discarding
% eth5: Designated Path Cost 200000
% eth5: Configured Path Cost 200000 - Add type Explicit ref count 1
% eth5: Designated Port Id 0x8004 - Priority 128 -
% eth5: Root 800052540046f549
% eth5: Designated Bridge 800052540065fd8c
% eth5: Message Age 1 - Max Age 20
% eth5: Hello Time 2 - Forward Delay 15
% eth5: Forward Timer 0 - Msg Age Timer 3 - Hello Timer 0 - topo change
timer 0
% eth5: forward-transitions 4
% eth5: Restricted-role OFF
% eth5: Version Rapid Spanning Tree Protocol - Receive RSTP - Send RSTP
% eth5: No portfast configured - Current portfast off
% eth5: bpdu-guard default - Current bpdu-guard off
% eth5: bpdu-filter default - Current bpdu-filter off
% eth5: no root guard configured - Current root guard off
% eth5: Configured Link Type point-to-point - Current point-to-point
% eth5: No auto-edge configured - Current port Auto Edge off
%
#

```

## Bridge 2

```

#show spanning-tree
% 2: Bridge up - Spanning Tree Enabled - topology change detected
% 2: Root Path Cost 200000 - Root Port 7 - Bridge Priority 32768
% 2: Forward Delay 15 - Hello Time 2 - Max Age 20 - Transmit Hold Count 6
% 2: Root Id 800052540046f549
% 2: Bridge Id 8000525400751db5
% 2: last topology change Tue Aug 11 02:25:00 2020
% 2: 22 topology change(s) - last topology change Tue Aug 11 02:25:00 2020

% 2: portfast bpdu-filter disabled
% 2: portfast bpdu-guard disabled
% eth2: Port Number 4 - Ifindex 4 - Port Id 0x8004 - Role Designated - State
Forwarding
% eth2: Designated Path Cost 200000
% eth2: Configured Path Cost 200000 - Add type Explicit ref count 1
% eth2: Designated Port Id 0x8004 - Priority 128 -
% eth2: Root 800052540046f549
% eth2: Designated Bridge 8000525400751db5
% eth2: Message Age 1 - Max Age 20
% eth2: Hello Time 2 - Forward Delay 15
% eth2: Forward Timer 0 - Msg Age Timer 0 - Hello Timer 0 - topo change
timer 0
% eth2: forward-transitions 3
% eth2: Restricted-role OFF

```

## RSTP Configuration

---

```
% eth2: Version Rapid Spanning Tree Protocol - Receive RSTP - Send RSTP
% eth2: No portfast configured - Current portfast off
% eth2: bpdu-guard default - Current bpdu-guard off
% eth2: bpdu-filter default - Current bpdu-filter off
% eth2: no root guard configured - Current root guard off
% eth2: Configured Link Type point-to-point - Current point-to-point
% eth2: No auto-edge configured - Current port Auto Edge off
%
% eth3: Port Number 5 - Ifindex 5 - Port Id 0x8005 - Role Designated - State
Forwarding
% eth3: Designated Path Cost 200000
% eth3: Configured Path Cost 200000 - Add type Explicit ref count 1
% eth3: Designated Port Id 0x8005 - Priority 128 -
% eth3: Root 800052540046f549
% eth3: Designated Bridge 8000525400751db5
% eth3: Message Age 1 - Max Age 20
% eth3: Hello Time 2 - Forward Delay 15
% eth3: Forward Timer 0 - Msg Age Timer 0 - Hello Timer 0 - topo change
timer 0
% eth3: forward-transitions 3
% eth3: Restricted-role OFF
% eth3: Version Rapid Spanning Tree Protocol - Receive RSTP - Send RSTP
% eth3: No portfast configured - Current portfast off
% eth3: bpdu-guard default - Current bpdu-guard off
% eth3: bpdu-filter default - Current bpdu-filter off
% eth3: no root guard configured - Current root guard off
% eth3: Configured Link Type point-to-point - Current point-to-point
% eth3: No auto-edge configured - Current port Auto Edge off
%
% eth4: Port Number 6 - Ifindex 6 - Port Id 0x8006 - Role Alternate - State
Discarding
% eth4: Designated Path Cost 0
% eth4: Configured Path Cost 200000 - Add type Explicit ref count 1
% eth4: Designated Port Id 0x8007 - Priority 128 -
% eth4: Root 800052540046f549
% eth4: Designated Bridge 800052540046f549
% eth4: Message Age 0 - Max Age 20
% eth4: Hello Time 2 - Forward Delay 15
% eth4: Forward Timer 0 - Msg Age Timer 4 - Hello Timer 0 - topo change
timer 0
% eth4: forward-transitions 3
% eth4: Restricted-role OFF
% eth4: Version Rapid Spanning Tree Protocol - Receive RSTP - Send RSTP
% eth4: No portfast configured - Current portfast off
% eth4: bpdu-guard default - Current bpdu-guard off
% eth4: bpdu-filter default - Current bpdu-filter off
% eth4: no root guard configured - Current root guard off
% eth4: Configured Link Type point-to-point - Current point-to-point
% eth4: No auto-edge configured - Current port Auto Edge off
%
% eth5: Port Number 7 - Ifindex 7 - Port Id 0x8007 - Role Rootport - State
Forwarding
% eth5: Designated Path Cost 0
% eth5: Configured Path Cost 200000 - Add type Explicit ref count 1
% eth5: Designated Port Id 0x8004 - Priority 128 -
% eth5: Root 800052540046f549
% eth5: Designated Bridge 800052540046f549
% eth5: Message Age 0 - Max Age 20
```

```
% eth5: Hello Time 2 - Forward Delay 15
% eth5: Forward Timer 0 - Msg Age Timer 4 - Hello Timer 0 - topo change
timer 0
% eth5: forward-transitions 2
% eth5: Restricted-role OFF
% eth5: Version Rapid Spanning Tree Protocol - Receive RSTP - Send RSTP
% eth5: No portfast configured - Current portfast off
% eth5: bpdu-guard default - Current bpdu-guard off
% eth5: bpdu-filter default - Current bpdu-filter off
% eth5: no root guard configured - Current root guard off
% eth5: Configured Link Type point-to-point - Current point-to-point
% eth5: No auto-edge configured - Current port Auto Edge off
%
#
```

### Bridge 3

```
#show spanning-tree
% 3: Bridge up - Spanning Tree Enabled - topology change detected
% 3: Root Path Cost 200000 - Root Port 5 - Bridge Priority 32768
% 3: Forward Delay 15 - Hello Time 2 - Max Age 20 - Transmit Hold Count 6
% 3: Root Id 800052540046f549
% 3: Bridge Id 800052540065fd8c
% 3: last topology change Tue Aug 11 02:25:00 2020
% 3: 16 topology change(s) - last topology change Tue Aug 11 02:25:00 2020

% 3: portfast bpdu-filter disabled
% 3: portfast bpdu-guard disabled
% eth2: Port Number 4 - Ifindex 4 - Port Id 0x8004 - Role Designated - State
Forwarding
% eth2: Designated Path Cost 200000
% eth2: Configured Path Cost 200000 - Add type Explicit ref count 1
% eth2: Designated Port Id 0x8004 - Priority 128 -
% eth2: Root 800052540046f549
% eth2: Designated Bridge 800052540065fd8c
% eth2: Message Age 1 - Max Age 20
% eth2: Hello Time 2 - Forward Delay 15
% eth2: Forward Timer 0 - Msg Age Timer 0 - Hello Timer 1 - topo change
timer 0
% eth2: forward-transitions 2
% eth2: Restricted-role OFF
% eth2: Version Rapid Spanning Tree Protocol - Receive RSTP - Send RSTP
% eth2: No portfast configured - Current portfast off
% eth2: bpdu-guard default - Current bpdu-guard off
% eth2: bpdu-filter default - Current bpdu-filter off
% eth2: no root guard configured - Current root guard off
% eth2: Configured Link Type point-to-point - Current point-to-point
% eth2: No auto-edge configured - Current port Auto Edge off
%
% eth3: Port Number 5 - Ifindex 5 - Port Id 0x8005 - Role Rootport - State
Forwarding
% eth3: Designated Path Cost 0
% eth3: Configured Path Cost 200000 - Add type Explicit ref count 1
% eth3: Designated Port Id 0x8005 - Priority 128 -
% eth3: Root 800052540046f549
% eth3: Designated Bridge 800052540046f549
% eth3: Message Age 0 - Max Age 20
% eth3: Hello Time 2 - Forward Delay 15
```

## RSTP Configuration

---

```
% eth3: Forward Timer 0 - Msg Age Timer 3 - Hello Timer 0 - topo change
timer 0
% eth3: forward-transitions 2
% eth3: Restricted-role OFF
% eth3: Version Rapid Spanning Tree Protocol - Receive RSTP - Send RSTP
% eth3: No portfast configured - Current portfast off
% eth3: bpdu-guard default - Current bpdu-guard off
% eth3: bpdu-filter default - Current bpdu-filter off
% eth3: no root guard configured - Current root guard off
% eth3: Configured Link Type point-to-point - Current point-to-point
% eth3: No auto-edge configured - Current port Auto Edge off
#
```

## Bridge 4

```
#show spanning-tree
% 4: Bridge up - Spanning Tree Enabled - topology change detected
% 4: Root Path Cost 0 - Root Port 0 - Bridge Priority 32768
% 4: Forward Delay 15 - Hello Time 2 - Max Age 20 - Transmit Hold Count 6
% 4: Root Id 800052540046f549
% 4: Bridge Id 800052540046f549
% 4: last topology change Tue Aug 11 02:24:58 2020
% 4: 6 topology change(s) - last topology change Tue Aug 11 02:24:58 2020

% 4: portfast bpdu-filter disabled
% 4: portfast bpdu-guard disabled
% eth2: Port Number 4 - Ifindex 4 - Port Id 0x8004 - Role Designated - State
Forwarding
% eth2: Designated Path Cost 0
% eth2: Configured Path Cost 200000 - Add type Explicit ref count 1
% eth2: Designated Port Id 0x8004 - Priority 128 -
% eth2: Root 800052540046f549
% eth2: Designated Bridge 800052540046f549
% eth2: Message Age 0 - Max Age 20
% eth2: Hello Time 2 - Forward Delay 15
% eth2: Forward Timer 0 - Msg Age Timer 0 - Hello Timer 0 - topo change
timer 0
% eth2: forward-transitions 1
% eth2: Restricted-role OFF
% eth2: Version Rapid Spanning Tree Protocol - Receive None - Send RSTP
% eth2: No portfast configured - Current portfast off
% eth2: bpdu-guard default - Current bpdu-guard off
% eth2: bpdu-filter default - Current bpdu-filter off
% eth2: no root guard configured - Current root guard off
% eth2: Configured Link Type point-to-point - Current point-to-point
% eth2: No auto-edge configured - Current port Auto Edge off
%
% eth3: Port Number 5 - Ifindex 5 - Port Id 0x8005 - Role Designated - State
Forwarding
% eth3: Designated Path Cost 0
% eth3: Configured Path Cost 200000 - Add type Explicit ref count 1
% eth3: Designated Port Id 0x8005 - Priority 128 -
% eth3: Root 800052540046f549
% eth3: Designated Bridge 800052540046f549
% eth3: Message Age 0 - Max Age 20
% eth3: Hello Time 2 - Forward Delay 15
% eth3: Forward Timer 0 - Msg Age Timer 0 - Hello Timer 0 - topo change
timer 0
```



```
% eth3: forward-transitions 1
% eth3: Restricted-role OFF
% eth3: Version Rapid Spanning Tree Protocol - Receive None - Send RSTP
% eth3: No portfast configured - Current portfast off
% eth3: bpdu-guard default - Current bpdu-guard off
% eth3: bpdu-filter default - Current bpdu-filter off
% eth3: no root guard configured - Current root guard off
% eth3: Configured Link Type point-to-point - Current point-to-point
% eth3: No auto-edge configured - Current port Auto Edge off
%
% eth4: Port Number 6 - Ifindex 6 - Port Id 0x8006 - Role Designated - State
Forwarding
% eth4: Designated Path Cost 0
% eth4: Configured Path Cost 200000 - Add type Explicit ref count 1
% eth4: Designated Port Id 0x8006 - Priority 128 -
% eth4: Root 800052540046f549
% eth4: Designated Bridge 800052540046f549
% eth4: Message Age 0 - Max Age 20
% eth4: Hello Time 2 - Forward Delay 15
% eth4: Forward Timer 0 - Msg Age Timer 0 - Hello Timer 0 - topo change
timer 0
% eth4: forward-transitions 1
% eth4: Restricted-role OFF
% eth4: Version Rapid Spanning Tree Protocol - Receive None - Send RSTP
% eth4: No portfast configured - Current portfast off
% eth4: bpdu-guard default - Current bpdu-guard off
% eth4: bpdu-filter default - Current bpdu-filter off
% eth4: no root guard configured - Current root guard off
% eth4: Configured Link Type point-to-point - Current point-to-point
% eth4: No auto-edge configured - Current port Auto Edge off
%
% eth5: Port Number 7 - Ifindex 7 - Port Id 0x8007 - Role Designated - State
Forwarding
% eth5: Designated Path Cost 0
% eth5: Configured Path Cost 200000 - Add type Explicit ref count 1
% eth5: Designated Port Id 0x8007 - Priority 128 -
% eth5: Root 800052540046f549
% eth5: Designated Bridge 800052540046f549
% eth5: Message Age 0 - Max Age 20
% eth5: Hello Time 2 - Forward Delay 15
% eth5: Forward Timer 0 - Msg Age Timer 0 - Hello Timer 0 - topo change
timer 0
% eth5: forward-transitions 1
% eth5: Restricted-role OFF
% eth5: Version Rapid Spanning Tree Protocol - Receive None - Send RSTP
% eth5: No portfast configured - Current portfast off
% eth5: bpdu-guard default - Current bpdu-guard off
% eth5: bpdu-filter default - Current bpdu-filter off
% eth5: no root guard configured - Current root guard off
% eth5: Configured Link Type point-to-point - Current point-to-point
% eth5: No auto-edge configured - Current port Auto Edge off
%
#
```



## CHAPTER 14 Spanning Tree Protocol Configuration

This chapter contains a complete sample Spanning Tree Protocol (STP) configuration.

Spanning Tree Protocol (STP) is a network protocol that ensures a loop-free topology for Ethernet networks. The basic function of STP is to prevent bridge loops. Spanning tree also allows a network design to include redundant links to provide automatic backup paths if an active link fails, thus, eliminating the need to manually enable or disable the backup links.

### Topology

The following example is a simple multi-bridge topology.

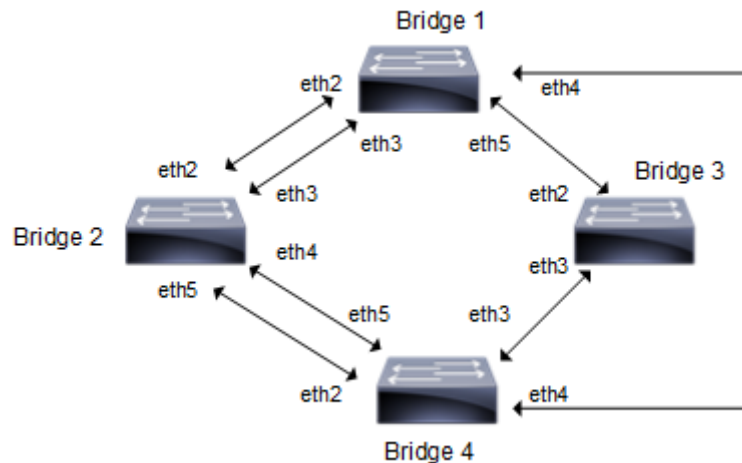

Figure 14-28: STP Topology

Note: Run the `switchport` command on each port to change to Layer-2 mode.

## Configurations

### Bridge 1

<code>Bridge1#configure terminal</code>	Enter configure mode.
<code>Bridge1(config)#bridge 1 protocol ieee</code>	Add a bridge (1) to the spanning tree table
<code>Bridge1(config)#interface eth2</code>	Enter interface mode.
<code>Bridge1(config-if)#bridge-group 1</code>	Associate the interface with bridge group 1.
<code>Bridge1(config-if)#commit</code>	Commit the transaction.
<code>Bridge1(config-if)#exit</code>	Exit interface mode.
<code>Bridge1(config)#interface eth3</code>	Enter interface mode.
<code>Bridge1(config-if)#bridge-group 1</code>	Associate the interface with bridge group 1.
<code>Bridge1(config-if)#commit</code>	Commit the transaction.
<code>Bridge1(config-if)#exit</code>	Exit interface mode.
<code>Bridge1(config)#interface eth4</code>	Enter interface mode.

## Spanning Tree Protocol Configuration

---

Bridge1 (config-if) #bridge-group 1	Associate the interface with bridge group 1.
Bridge1 (config-if) #commit	Commit the transaction.
Bridge1 (config-if) #exit	Exit interface mode.
Bridge1 (config) #interface eth5	Enter interface mode
Bridge1 (config-if) #bridge-group 1	Associate the interface with bridge group 1.
Bridge1 (config-if) #commit	Commit the transaction.

---

### Bridge 2

Bridge2#configure terminal	Enter configure mode.
Bridge2 (config) #bridge 2 protocol ieee	Add a bridge (2) to the spanning tree table
Bridge2 (config) #interface eth2	Enter interface mode.
Bridge2 (config-if) #bridge-group 2	Associate the interface with bridge group 2.
Bridge2 (config-if) #commit	Commit the transaction.
Bridge2 (config-if) #exit	Exit interface mode.
Bridge2 (config) #interface eth3	Enter interface mode.
Bridge2 (config-if) #bridge-group 2	Associate the interface with bridge group 2.
Bridge2 (config-if) #commit	Commit the transaction.
Bridge2 (config-if) #exit	Exit interface mode.
Bridge2 (config) #interface eth4	Enter interface mode.
Bridge2 (config-if) #bridge-group 2	Associate the interface with bridge group 2.
Bridge2 (config-if) #commit	Commit the transaction.
Bridge2 (config-if) #exit	Exit interface mode.
Bridge2 (config) #interface eth5	Enter interface mode
Bridge2 (config-if) #bridge-group 2	Associate the interface with bridge group 2.
Bridge2 (config-if) #commit	Commit the transaction.

---

### Bridge 4

Bridge4#configure terminal	Enter configure mode.
Bridge4 (config) #bridge 4 protocol ieee	Add a bridge (4) to the spanning tree table
Bridge4 (config) #interface eth2	Enter interface mode.
Bridge4 (config-if) #bridge-group 4	Associate the interface with bridge group 4.
Bridge4 (config-if) #commit	Commit the transaction.
Bridge4 (config-if) #exit	Exit interface mode.
Bridge4 (config) #interface eth3	Enter interface mode.
Bridge4 (config-if) #bridge-group 4	Associate the interface with bridge group 4.
Bridge1 (config-if) #commit	Commit the transaction.
Bridge4 (config-if) #exit	Exit interface mode.
Bridge4 (config) #interface eth4	Enter interface mode.
Bridge4 (config-if) #bridge-group 4	Associate the interface with bridge group 4.
Bridge4 (config-if) #commit	Commit the transaction.

---

Bridge4(config-if)#exit	Exit interface mode.
Bridge4(config)#interface eth5	Enter interface mode
Bridge4(config-if)#bridge-group 4	Associate the interface with bridge group 4.
Bridge4(config-if)#commit	Commit the transaction.

### Bridge 3

Bridge3#configure terminal	Enter configure mode.
Bridge3(config)#bridge 3 protocol ieee	Add a bridge (3) to the spanning tree table
Bridge3(config)#interface eth2	Enter interface mode.
Bridge3(config-if)#bridge-group 3	Associate the interface with bridge group 3.
Bridge3(config-if)#commit	Commit the transaction.
Bridge3(config-if)#exit	Exit interface mode.
Bridge3(config)#interface eth3	Enter interface mode.
Bridge3(config-if)#bridge-group 3	Associate the interface with bridge group 3.
Bridge3(config-if)#commit	Commit the transaction.

## Validation

show spanning-tree, show spanning-tree interface <if-name>

### Bridge 1

```
#show spanning-tree
1: Bridge up - Spanning Tree Enabled - topology change detected
1: Root Path Cost 19 - Root Port 6 - Bridge Priority 32768
1: Forward Delay 15 - Hello Time 2 - Max Age 20 - Transmit Hold Count 6
1: Root Id 800052540046f549
1: Bridge Id 80005254009cb7e6
1: last topology change Tue Aug 11 02:25:01 2020
1: 30 topology change(s) - last topology change Tue Aug 11 02:25:01 2020
1: portfast bpdu-filter disabled
1: portfast bpdu-guard disabled
eth2: Port Number 4 - Ifindex 4 - Port Id 0x8004 -State Blocked
eth2: Designated Path Cost 19
eth2: Configured Path Cost 19 - Add type Explicit ref count 1
eth2: Designated Port Id 0x8004 - Priority 128 -
eth2: Root 800052540046f549
eth2: Designated Bridge 8000525400751db5
eth2: Message Age 1 - Max Age 20
eth2: Hello Time 2 - Forward Delay 15
eth2: Forward Timer 0 - Msg Age Timer 4 - Hello Timer 0 - topo change timer 0
eth3: Port Number 5 - Ifindex 5 - Port Id 0x8005 - State blocked
eth3: Designated Path Cost 19
eth3: Configured Path Cost 19 - Add type Explicit ref count 1
eth3: Designated Port Id 0x8005 - Priority 128 -
eth3: Root 800052540046f549
eth3: Designated Bridge 8000525400751db5
eth3: Message Age 1 - Max Age 20
eth3: Hello Time 2 - Forward Delay 15
eth3: Forward Timer 0 - Msg Age Timer 3 - Hello Timer 0 - topo change timer 0
```

## Spanning Tree Protocol Configuration

---

```
eth3: forward-transitions 3
eth3: Restricted-role OFF
eth3: No portfast configured - Current portfast off
eth3: bpdu-guard default - Current bpdu-guard off
eth3: bpdu-filter default - Current bpdu-filter off
eth3: no root guard configured - Current root guard off
eth3: Configured Link Type point-to-point - Current point-to-point
eth3: No auto-edge configured - Current port Auto Edge off
eth4: Port Number 6-Ifindex 6-Port Id 0x8006-Role Rootport-State Forwarding
eth4: Designated Path Cost 0
eth4: Configured Path Cost 19 - Add type Explicit ref count 1
eth4: Designated Port Id 0x8006 - Priority 128 -
eth4: Root 800052540046f549
eth4: Designated Bridge 800052540046f549
eth4: Message Age 0 - Max Age 20
eth4: Hello Time 2 - Forward Delay 15
eth4: Forward Timer 0 - Msg Age Timer 3-Hello Timer 0 - topo changen timer 0
eth4: forward-transitions 6
eth4: Restricted-role OFF
eth4: No portfast configured - Current portfast off
eth4: bpdu-guard default - Current bpdu-guard off
eth4: bpdu-filter default - Current bpdu-filter off
eth4: no root guard configured - Current root guard off
eth4: Configured Link Type point-to-point - Current point-to-point
eth4: No auto-edge configured - Current port Auto Edge off
eth5: Port Number 7 - Ifindex 7 - Port Id 0x8007 - State Blocked
eth5: Designated Path Cost 19
eth5: Configured Path Cost 19 - Add type Explicit ref count 1
eth5: Designated Port Id 0x8004 - Priority 128 -
eth5: Root 800052540046f549
eth5: Designated Bridge 800052540065fd8c
eth5: Message Age 1 - Max Age 20
eth5: Hello Time 2 - Forward Delay 15
eth5: Forward Timer 0 - Msg Age Timer 3 - Hello Timer 0 - topo change timer 0
eth5: forward-transitions 4
eth5: Restricted-role OFF
eth5: No portfast configured - Current portfast off
eth5: bpdu-guard default - Current bpdu-guard off
eth5: bpdu-filter default - Current bpdu-filter off
eth5: no root guard configured - Current root guard off
eth5: Configured Link Type point-to-point - Current point-to-point
eth5: No auto-edge configured - Current port Auto Edge off
```

## Bridge 2

```
#show spanning-tree
2: Bridge up - Spanning Tree Enabled - topology change detected
2: Root Path Cost 19 - Root Port 7 - Bridge Priority 32768
2: Forward Delay 15 - Hello Time 2 - Max Age 20 - Transmit Hold Count 6
2: Root Id 800052540046f549
2: Bridge Id 8000525400751db5
2: last topology change Tue Aug 11 02:25:00 2020
2: 22 topology change(s) - last topology change Tue Aug 11 02:25:00 2020
2: portfast bpdu-filter disabled
2: portfast bpdu-guard disabled
eth2: Port Number 4-Ifindex 4-Port Id 0x8004-Role Designated-State Forwarding
eth2: Designated Path Cost 19
```

---

```
eth2: Configured Path Cost 19 - Add type Explicit ref count 1
eth2: Designated Port Id 0x8004 - Priority 128 -
eth2: Root 800052540046f549
eth2: Designated Bridge 8000525400751db5
eth2: Message Age 1 - Max Age 20
eth2: Hello Time 2 - Forward Delay 15
eth2: Forward Timer 0 - Msg Age Timer 0 - Hello Timer 0 - topo change timer 0
eth2: forward-transitions 3
eth2: Restricted-role OFF
eth2: No portfast configured - Current portfast off
eth2: bpdu-guard default - Current bpdu-guard off
eth2: bpdu-filter default - Current bpdu-filter off
eth2: no root guard configured - Current root guard off
eth2: Configured Link Type point-to-point - Current point-to-point
eth2: No auto-edge configured - Current port Auto Edge off
eth3: Port Number 5-Ifindex 5-Port Id 0x8005-Role Designated-State Forwarding
eth3: Designated Path Cost 19
eth3: Configured Path Cost 19 - Add type Explicit ref count 1
eth3: Designated Port Id 0x8005 - Priority 128 -
eth3: Root 800052540046f549
eth3: Designated Bridge 8000525400751db5
eth3: Message Age 1 - Max Age 20
eth3: Hello Time 2 - Forward Delay 15
eth3: Forward Timer 0-Msg Age Timer 0-Hello Timer 0-topo change timer 0
eth3: forward-transitions 3
eth3: Restricted-role OFF
eth3: No portfast configured - Current portfast off
eth3: bpdu-guard default - Current bpdu-guard off
eth3: bpdu-filter default - Current bpdu-filter off
eth3: no root guard configured - Current root guard off
eth3: Configured Link Type point-to-point - Current point-to-point
eth3: No auto-edge configured - Current port Auto Edge off
eth4: Port Number 6 - Ifindex 6 - Port Id 0x8006 ---State Blocked
eth4: Designated Path Cost 0
eth4: Configured Path Cost 19 - Add type Explicit ref count 1
eth4: Designated Port Id 0x8007 - Priority 128 -
eth4: Root 800052540046f549
eth4: Designated Bridge 800052540046f549
eth4: Message Age 0 - Max Age 20
eth4: Hello Time 2 - Forward Delay 15
eth4: Forward Timer 0-Msg Age Timer 4-Hello Timer 0-topo change timer 0
eth4: forward-transitions 3
eth4: Restricted-role OFF
eth4: No portfast configured - Current portfast off
eth4: bpdu-guard default - Current bpdu-guard off
eth4: bpdu-filter default - Current bpdu-filter off
eth4: no root guard configured - Current root guard off
eth4: Configured Link Type point-to-point - Current point-to-point
eth4: No auto-edge configured - Current port Auto Edge off
eth5: Port Number 7-Ifindex 7-Port Id 0x8007-Role Rootport-State Forwarding
eth5: Designated Path Cost 0
eth5: Configured Path Cost 19 - Add type Explicit ref count 1
eth5: Designated Port Id 0x8004 - Priority 128 -
eth5: Root 800052540046f549
eth5: Designated Bridge 800052540046f549
eth5: Message Age 0 - Max Age 20
eth5: Hello Time 2 - Forward Delay 15
```

## Spanning Tree Protocol Configuration

---

```
eth5: Forward Timer 0-Msg Age Timer 4-Hello Timer 0-topo change timer 0
eth5: forward-transitions 2
eth5: Restricted-role OFF
eth5: No portfast configured - Current portfast off
eth5: bpdu-guard default - Current bpdu-guard off
eth5: bpdu-filter default - Current bpdu-filter off
eth5: no root guard configured - Current root guard off
eth5: Configured Link Type point-to-point - Current point-to-point
eth5: No auto-edge configured - Current port Auto Edge off
```

### Bridge 3

```
#show spanning-tree
3: Bridge up - Spanning Tree Enabled - topology change detected
3: Root Path Cost 19 - Root Port 5 - Bridge Priority 32768
3: Forward Delay 15 - Hello Time 2 - Max Age 20 - Transmit Hold Count 6
3: Root Id 800052540046f549
3: Bridge Id 800052540065fd8c
3: last topology change Tue Aug 11 02:25:00 2020
3: 16 topology change(s) - last topology change Tue Aug 11 02:25:00 2020
3: portfast bpdu-filter disabled
3: portfast bpdu-guard disabled
eth2: Port Number 4-Ifindex 4-Port Id 0x8004-Role Designated-State Forwarding
eth2: Designated Path Cost 19
eth2: Configured Path Cost 19 - Add type Explicit ref count 1
eth2: Designated Port Id 0x8004 - Priority 128 -
eth2: Root 800052540046f549
eth2: Designated Bridge 800052540065fd8c
eth2: Message Age 1 - Max Age 20
eth2: Hello Time 2 - Forward Delay 15
eth2: Forward Timer 0-Msg Age Timer 0-Hello Timer 1-topo change timer 0
eth2: forward-transitions 2
eth2: Restricted-role OFF
eth2: No portfast configured - Current portfast off
eth2: bpdu-guard default - Current bpdu-guard off
eth2: bpdu-filter default - Current bpdu-filter off
eth2: no root guard configured - Current root guard off
eth2: Configured Link Type point-to-point - Current point-to-point
eth2: No auto-edge configured - Current port Auto Edge off
eth3: Port Number 5-Ifindex 5-Port Id 0x8005-Role Rootport - State Forwarding
eth3: Designated Path Cost 0
eth3: Configured Path Cost 19 - Add type Explicit ref count 1
eth3: Designated Port Id 0x8005 - Priority 128 -
eth3: Root 800052540046f549
eth3: Designated Bridge 800052540046f549
eth3: Message Age 0 - Max Age 20
eth3: Hello Time 2 - Forward Delay 15
eth3: Forward Timer 0 - Msg Age Timer 3 - Hello Timer 0 - topo change timer 0
eth3: forward-transitions 2
eth3: Restricted-role OFF
eth3: No portfast configured - Current portfast off
eth3: bpdu-guard default - Current bpdu-guard off
eth3: bpdu-filter default - Current bpdu-filter off
eth3: no root guard configured - Current root guard off
eth3: Configured Link Type point-to-point - Current point-to-point
eth3: No auto-edge configured - Current port Auto Edge off
```



**Bridge 4**

```
#show spanning-tree
4: Bridge up - Spanning Tree Enabled - topology change detected
4: Root Path Cost 0 - Root Port 0 - Bridge Priority 32768
4: Forward Delay 15 - Hello Time 2 - Max Age 20 - Transmit Hold Count 6
4: Root Id 800052540046f549
4: Bridge Id 800052540046f549
4: last topology change Tue Aug 11 02:24:58 2020
4: 6 topology change(s) - last topology change Tue Aug 11 02:24:58 2020
4: portfast bpdu-filter disabled
4: portfast bpdu-guard disabled
eth2: Port Number 4-Ifindex 4-Port Id 0x8004-Role Designated-State Forwarding
eth2: Designated Path Cost 0
eth2: Configured Path Cost 19 - Add type Explicit ref count 1
eth2: Designated Port Id 0x8004 - Priority 128 -
eth2: Root 800052540046f549
eth2: Designated Bridge 800052540046f549
eth2: Message Age 0 - Max Age 20
eth2: Hello Time 2 - Forward Delay 15
eth2: Forward Timer 0-Msg Age Timer 0-Hello Timer 0-topo change timer 0
eth2: forward-transitions 1
eth2: Restricted-role OFF
eth2: No portfast configured - Current portfast off
eth2: bpdu-guard default - Current bpdu-guard off
eth2: bpdu-filter default - Current bpdu-filter off
eth2: no root guard configured - Current root guard off
eth2: Configured Link Type point-to-point - Current point-to-point
eth2: No auto-edge configured - Current port Auto Edge off
eth3: Port Number 5-Ifindex 5-Port Id 0x8005-Role Designated-State Forwarding
eth3: Designated Path Cost 0
eth3: Configured Path Cost 19 - Add type Explicit ref count 1
eth3: Designated Port Id 0x8005 - Priority 128 -
eth3: Root 800052540046f549
eth3: Designated Bridge 800052540046f549
eth3: Message Age 0 - Max Age 20
eth3: Hello Time 2 - Forward Delay 15
eth3: Forward Timer 0-Msg Age Timer 0-Hello Timer 0-topo change timer 0
eth3: forward-transitions 1
eth3: Restricted-role OFF
eth3: No portfast configured - Current portfast off
eth3: bpdu-guard default - Current bpdu-guard off
eth3: bpdu-filter default - Current bpdu-filter off
eth3: no root guard configured - Current root guard off
eth3: Configured Link Type point-to-point - Current point-to-point
eth3: No auto-edge configured - Current port Auto Edge off
eth4: Port Number 6-Ifindex 6-Port Id 0x8006-Role Designated-State Forwarding
eth4: Designated Path Cost 0
eth4: Configured Path Cost 19 - Add type Explicit ref count 1
eth4: Designated Port Id 0x8006 - Priority 128 -
eth4: Root 800052540046f549
eth4: Designated Bridge 800052540046f549
eth4: Message Age 0 - Max Age 20
eth4: Hello Time 2 - Forward Delay 15
eth4: Forward Timer 0-Msg Age Timer 0-Hello Timer 0-topo change timer 0
```

```
eth4: forward-transitions 1
eth4: Restricted-role OFF
eth4: No portfast configured - Current portfast off
eth4: bpdu-guard default - Current bpdu-guard off
eth4: bpdu-filter default - Current bpdu-filter off
eth4: no root guard configured - Current root guard off
eth4: Configured Link Type point-to-point - Current point-to-point
eth4: No auto-edge configured - Current port Auto Edge off
eth5: Port Number 7-Ifindex 7-Port Id 0x8007-Role Designated-State Forwarding
eth5: Designated Path Cost 0
eth5: Configured Path Cost 19 - Add type Explicit ref count 1
eth5: Designated Port Id 0x8007 - Priority 128 -
eth5: Root 800052540046f549
eth5: Designated Bridge 800052540046f549
eth5: Message Age 0 - Max Age 20
eth5: Hello Time 2 - Forward Delay 15
eth5: Forward Timer 0-Msg Age Timer 0-Hello Timer 0-topo change timer 0
eth5: forward-transitions 1
eth5: Restricted-role OFF
eth5: No portfast configured - Current portfast off
eth5: bpdu-guard default - Current bpdu-guard off
eth5: bpdu-filter default - Current bpdu-filter off
eth5: no root guard configured - Current root guard off
eth5: Configured Link Type point-to-point - Current point-to-point
eth5: No auto-edge configured - Current port Auto Edge off
```

## CHAPTER 15 VLAN Configuration

This chapter contains a complete VLAN configuration.

### Configuring VLAN Tags

#### Topology

This shows configuring a VLAN bridge with VLAN tags on forwarding frames. Link between Bridge 1 and Bridge 2 is configured as VLAN 5 and link between Bridge 3 and Bridge 1 is configured as VLAN 10. Link between Bridge 2 and Bridge 3 is configured with VLAN 5 and VLAN 10.

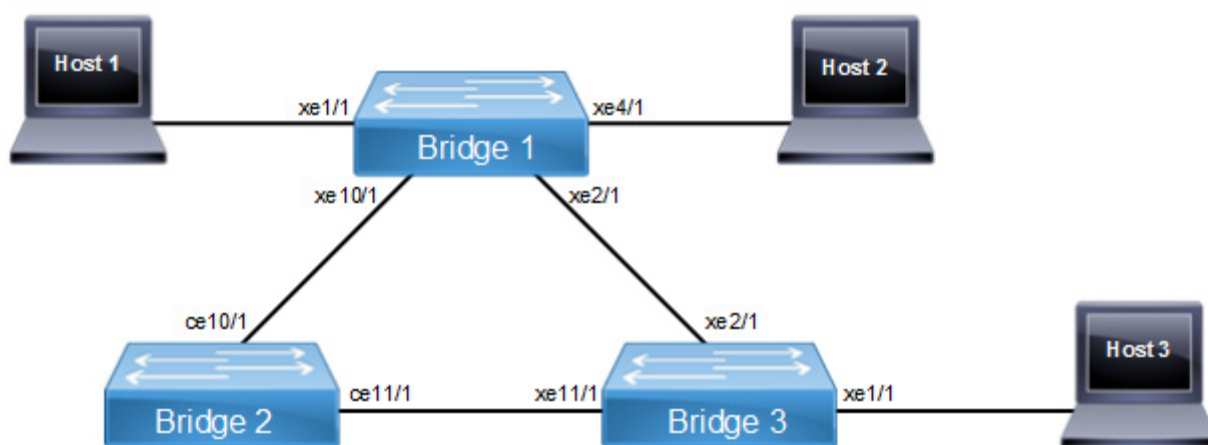

Figure 15-29: VLAN Topology

Note: Run the `switchport` command on each port to change to Layer-2 mode.

#### Bridge 1

<code>Bridgel#configure terminal</code>	Enter configuration mode
<code>Bridgel(config)#bridge 1 protocol ieee vlan-bridge</code>	Specify VLAN for bridge 1.
<code>Bridgel(config)#vlan database</code>	Enter the VLAN configuration mode.
<code>Bridgel(config-if)#vlan 5 bridge 1 state enable</code>	Enable VLAN (5) on bridge 1. Specifying the enable state allows forwarding of frames on this VLAN-aware bridge.
<code>Bridgel(config-if)#vlan 10 bridge 1 state enable</code>	Enable VLAN (10) on bridge 1. Specifying the enable state allows forwarding of frames on this VLAN-aware bridge.
<code>Bridgel(config-if)#commit</code>	Commit candidate configuration to be running configuration
<code>Bridgel(config-if)#exit</code>	Exit the VLAN configuration mode.
<code>Bridgel(config)#interface xe1/1</code>	Enter interface mode.
<code>Bridgel(config-if)#switchport</code>	Configure port as L2.
<code>Bridgel(config-if)#bridge-group 1</code>	Associate the interface with bridge group 1.
<code>Bridgel(config-if)#switchport mode access</code>	Set the switching characteristics of this interface to access mode.

## VLAN Configuration

<code>Bridge1(config-if)#switchport access vlan 5</code>	Enable VLAN ID 5 on this port.
<code>Bridge1(config-if)#commit</code>	Commit candidate configuration to be running configuration
<code>Bridge1(config-if)#exit</code>	Exit from the interface mode and go config mode.
<code>Bridge1(config)#interface xe2/1</code>	Enter interface mode.
<code>Bridge1(config-if)#switchport</code>	Configure port as L2.
<code>Bridge1(config-if)#bridge-group 1</code>	Associate the interface with bridge group 1.
<code>Bridge1(config-if)#switchport mode trunk</code>	Set the switching characteristics of this interface to trunk mode.
<code>Bridge1(config-if)#switchport trunk allowed vlan add 10</code>	Enable VLAN ID 10 on this port.
<code>Bridge1(config-if)#commit</code>	Commit candidate configuration to be running configuration
<code>Bridge1(config-if)#exit</code>	Exit from the interface mode and go config mode.
<code>Bridge1(config)#interface xe4/1</code>	Enter interface mode.
<code>Bridge1(config-if)#switchport</code>	Configure port as L2.
<code>Bridge1(config-if)#bridge-group 1</code>	Associate the interface with bridge group 1.
<code>Bridge1(config-if)#switchport mode access</code>	Set the switching characteristics of this interface to access mode.
<code>Bridge1(config-if)#switchport access vlan 10</code>	Enable VLAN ID 10 on this port.
<code>Bridge1(config-if)#exit</code>	Exit from the interface mode and go config mode.
<code>Bridge1(config)#interface xe10/1</code>	Enter interface mode.
<code>Bridge1(config-if)#switchport</code>	Configure port as L2.
<code>Bridge1(config-if)#bridge-group 1</code>	Associate the interface with bridge group 1.
<code>Bridge1(config-if)#switchport mode trunk</code>	Set the switching characteristics of this interface to trunk mode.
<code>Bridge1(config-if)#switchport trunk allowed vlan add 5</code>	Enable VLAN ID 5 on this port.
<code>Bridge1(config-if)#commit</code>	Commit candidate configuration to be running configuration
<code>Bridge1(config-if)#exit</code>	Exit from the interface mode and go config mode.

## Bridge 2

<code>Bridge2#configure terminal</code>	Enter configure mode.
<code>Bridge2(config)#bridge 2 protocol ieee vlan-bridge</code>	Specify VLAN for bridge 2.
<code>Bridge2(config)#vlan database</code>	Enter the VLAN configuration mode.
<code>Bridge2(config-vlan)#vlan 5 bridge 2 state enable</code>	Enable VLAN (5) on bridge 2. Specifying the enable state allows forwarding of frames on this VLAN-aware bridge.
<code>Bridge2(config-vlan)#vlan 10 bridge 2 state enable</code>	Specifying the enable state allows forwarding of frames on this VLAN-aware bridge.
<code>Bridge2(config-vlan)#commit</code>	Commit candidate configuration to be running configuration
<code>Bridge2(config-vlan)#exit</code>	Exit the VLAN configuration mode.
<code>Bridge2(config)#interface ce10/1</code>	Enter interface mode.
<code>Bridge2(config-if)#switchport</code>	
<code>Bridge2(config-if)#bridge-group 2</code>	Associate the interface with bridge group 2.

Bridge2(config-if)#switchport mode trunk	Set the switching characteristics of this interface to trunk mode.
Bridge2(config-if)#switchport access vlan 5	Enable VLAN port access by specifying the VLAN ID 5 on this interface.
Bridge2(config-if)#switchport trunk allowed vlan add 10	Enable VLAN ID 10 on this port.
Bridge2(config-if)#switchport	Configure port as L2.
Bridge2(config-if)#bridge-group 2	Associate the interface with bridge group 2.
Bridge2(config-if)#switchport mode trunk	Set the switching characteristics of this interface to trunk mode.
Bridge2(config-if)#switchport trunk allowed vlan add 5	Enable VLAN ID 5 on this port.
Bridge2(config-if)#switchport trunk allowed vlan add 10	Enable VLAN ID 10 on this port.
Bridge2(config-if)#commit	Commit candidate configuration to be running configuration
Bridge2(config-if)#exit	Exit from the interface mode and go config mode.
Bridge2(config)#interface cell1/1	Enter interface mode.
Bridge2(config-if)#switchport	Configure port as L2.
Bridge2(config-if)#bridge-group 2	Associate the interface with bridge group 2.
Bridge2(config-if)#switchport mode trunk	Set the switching characteristics of this interface to trunk mode.
Bridge2(config-if)#switchport trunk allowed vlan add 5	Enable VLAN ID 5 on this port.
Bridge2(config-if)#switchport trunk allowed vlan add 10	Enable VLAN ID 10 on this port.
Bridge2(config-if)#commit	Commit candidate configuration to be running configuration
Bridge2(config-if)#exit	Exit from the interface mode and go config mode.

### Bridge 3

Bridge3#configure terminal	Enter configure mode.
Bridge3(config)#bridge 3 protocol ieee vlan-bridge	Specify VLAN for bridge 3.
Bridge3(config)#vlan database	Enter the VLAN configuration mode.
Bridge3(config-vlan)#vlan 5 bridge 3 state enable	Enable VLAN (5) on bridge 3. Specifying the enable state allows forwarding of frames on this VLAN-aware bridge.
Bridge3(config-vlan)#vlan 10 bridge 3 state enable	Enable VLAN (10) on bridge 3. Specifying the enable state allows forwarding of frames on this VLAN-aware bridge.
Bridge3(config-vlan)#commit	Commit candidate configuration to be running configuration
Bridge3(config-vlan)#exit	Exit the VLAN configuration mode.
Bridge3(config)#interface xe1/1	Enter interface mode.
Bridge3(config-if)#switchport	Configure port as L2.
Bridge3(config-if)#bridge-group 3	Associate the interface with bridge group 3.
Bridge3(config-if)#switchport mode access	Set the switching characteristics of this interface to access mode.

## VLAN Configuration

---

Bridge3(config-if)#switchport access vlan 5	Enable VLAN ID 5 on this port.
Bridge3(config-if)#switchport access vlan 10	Enable VLAN ID 10 on this port.
Bridge3(config-if)#commit	Commit candidate configuration to be running configuration
Bridge3(config-if)#exit	Exit from the interface mode and go config mode.
Bridge3(config)#interface xe2/1	Enter interface mode.
Bridge3(config-if)#switchport	Configure port as L2.
Bridge3(config-if)#bridge-group 3	Associate the interface with bridge group 3.
Bridge3(config-if)#switchport mode trunk	Set the switching characteristics of this interface to trunk mode.
Bridge3(config-if)#switchport trunk allowed vlan add 10	Enable VLAN ID 10 on this port.
Bridge3(config-if)#commit	Commit candidate configuration to be running configuration
Bridge3(config-if)#exit	Exit from the interface mode and go config mode.
Bridge3(config)#interface xe11/1	Enter interface mode.
Bridge3(config-if)#switchport	Configure port as L2.
Bridge3(config-if)#bridge-group 3	Associate the interface with bridge group 3.
Bridge3(config-if)#switchport mode trunk	Set the switching characteristics of this interface to trunk mode.
Bridge3(config-if)#switchport trunk allowed vlan add 5	Enable VLAN ID 5 on this port.
Bridge3(config-if)#commit	Commit candidate configuration to be running configuration
Bridge3(config-if)#exit	Exit from the interface mode and go config mode.

---

## Validation

### Bridge 1

```
Bridge1#show spanning-tree
% 1: Bridge up - Spanning Tree Enabled
% 1: Root Path Cost 1 - Priority 32768
% 1: Forward Delay 15 - Hello Time 2 - Max Age 20 - Transmit Hold Count 6 - Root port 909
% 1: Root Id 8000001823304db6
% 1: Bridge Id 8000001823305244
% 1: 6 topology changes - last topology change Fri Apr 19 12:32:26 2019
% 1: portfast bpdu-filter disabled
% 1: portfast bpdu-guard disabled
% 1: portfast errdisable timeout disabled
% 1: portfast errdisable timeout interval 300 sec
% xe1/1: Port Number 905 - Ifindex 5001 - Port Id 0x8389 - path cost 4 - designated cost 1
% xe1/1: Designated Port Id 0x8389 - state Forwarding -Priority 128
% xe1/1: Designated root 8000001823304db6
% xe1/1: Designated Bridge 8000001823305244
% xe1/1: Message Age 1 - Max Age 20
% xe1/1: Hello Time 2 - Forward Delay 15
% xe1/1: Forward Timer 0 - Msg Age Timer 0 - Hello Timer 0 - topo change timer 0
% xe1/1: forward-transitions 1
```

```

% xe1/1: No portfast configured - Current portfast off
% xe1/1: bpdu-guard default - Current bpdu-guard off
% xe1/1: bpdu-filter default - Current bpdu-filter off
% xe1/1: no root guard configured - Current root guard off
%
% xe2/1: Port Number 909 - Ifindex 5005 - Port Id 0x838d - path cost 1 - designated
cost 0
% xe2/1: Designated Port Id 0x838d - state Forwarding -Priority 128
% xe2/1: Designated root 8000001823304db6
% xe2/1: Designated Bridge 8000001823304db6
% xe2/1: Message Age 0 - Max Age 20
% xe2/1: Hello Time 2 - Forward Delay 15
% xe2/1: Forward Timer 0 - Msg Age Timer 19 - Hello Timer 0 - topo change timer 0
% xe2/1: forward-transitions 2
% xe2/1: No portfast configured - Current portfast off
% xe2/1: bpdu-guard default - Current bpdu-guard off
% xe2/1: bpdu-filter default - Current bpdu-filter off
% xe2/1: no root guard configured - Current root guard off
%
% xe4/1: Port Number 917 - Ifindex 5013 - Port Id 0x8395 - path cost 4 - designated
cost 1
% xe4/1: Designated Port Id 0x8395 - state Forwarding -Priority 128
% xe4/1: Designated root 8000001823304db6
% xe4/1: Designated Bridge 8000001823305244
% xe4/1: Message Age 1 - Max Age 20
% xe4/1: Hello Time 2 - Forward Delay 15
% xe4/1: Forward Timer 0 - Msg Age Timer 0 - Hello Timer 1 - topo change timer 0
% xe4/1: forward-transitions 1
% xe4/1: No portfast configured - Current portfast off
% xe4/1: bpdu-guard default - Current bpdu-guard off
% xe4/1: bpdu-filter default - Current bpdu-filter off
% xe4/1: no root guard configured - Current root guard off
%
% xe10/1: Port Number 941 - Ifindex 5037 - Port Id 0x83ad - path cost 2 - designated
cost 1
% xe10/1: Designated Port Id 0x83ad - state Forwarding -Priority 128
% xe10/1: Designated root 8000001823304db6
% xe10/1: Designated Bridge 8000001823305244
% xe10/1: Message Age 1 - Max Age 20
% xe10/1: Hello Time 2 - Forward Delay 15
% xe10/1: Forward Timer 0 - Msg Age Timer 0 - Hello Timer 0 - topo change timer 0
% xe10/1: forward-transitions 2
% xe10/1: No portfast configured - Current portfast off
% xe10/1: bpdu-guard default - Current bpdu-guard off
% xe10/1: bpdu-filter default - Current bpdu-filter off
% xe10/1: no root guard configured - Current root guard off
%

```

B1#show bridge

Ageout time is global and if something is configured for vxlan then it will be affected here also

Bridge	CVLAN	SVLAN	BVLAN	Port	MAC Address	FWD	Time-out
--------	-------	-------	-------	------	-------------	-----	----------

## VLAN Configuration

```
-----+-----+-----+-----+-----+-----+-----+-----+
1          1          xe2/1          0018.23cb.fbbc          1          300
1          1          xe10/1         cc37.ab97.37d8          1          300
1          5          xe1/1          0000.11bc.5dec          1          300
1          10         xe4/1          0000.2d50.205c          1          300
Bridgel#
```

Bridgel#show vlan all bridge 1

```
Bridge  VLAN ID      Name           State   H/W Status      Member ports
                               (u)-Untagged, (t)-Tagged
=====  =====  =====
1         1         default       ACTIVE  Success         xe1/1(u) xe2/1(u) xe4/1(u)
                               xe10/1(u)
1         5         VLAN0005     ACTIVE  Success         xe1/1(t) xe10/1(t)
1         10        VLAN0010     ACTIVE  Success         xe2/1(t) xe4/1(t)
```

Bridgel#show bridge

Ageout time is global and if something is configured for vxlan then it will be affected here also

```
Bridge  CVLAN  SVLAN  BVLAN  Port          MAC Address          FWD  Time-out
-----+-----+-----+-----+-----+-----+-----+-----+
1         1          xe2/1          0018.23cb.fbbc          1          300
1         1          xe10/1         cc37.ab97.37d8          1          300
1         5          xe1/1          0000.11bc.5dec          1          300
1         10         xe4/1          0000.2d50.205c          1          300
```

Bridgel#

## Bridge 2

Bridge2#show bridge

Ageout time is global and if something is configured for vxlan then it will be affected here also

```
Bridge  CVLAN  SVLAN  BVLAN  Port          MAC Address          FWD  Time-out
-----+-----+-----+-----+-----+-----+-----+-----+
2         1          ce10/1         0018.2326.166a          1          300
2         1          ce11/1         0018.23cb.fbe0          1          300
2         1          ce11/1         cc37.ab97.37d8          1          300
2         5          ce10/1         0000.11bc.5dec          1          300
```

Bridge2#show vlan all bridge 2

```
Bridge  VLAN ID      Name           State   H/W Status      Member ports
                               (u)-Untagged, (t)-Tagged
=====  =====  =====
2         1         default       ACTIVE  Success         ce10/1(u) ce11/1(u)
2         5         VLAN0005     ACTIVE  Success         ce10/1(t) ce11/1(t)
2         10        VLAN0010     ACTIVE  Success         ce10/1(t) ce11/1(t)
```

Bridge2#show bridge



Ageout time is global and if something is configured for vxlan then it will be affected here also

Bridge	CVLAN	SVLAN	BVLAN	Port	MAC Address	FWD	Time-out
2	1			ce10/1	0018.2326.166a	1	300
2	1			ce11/1	0018.23cb.fbe0	1	300
2	1			ce11/1	cc37.ab97.37d8	1	300
2	5			ce10/1	0000.11bc.5dec	1	300

### Bridge 3

Bridge3# show bridge

Ageout time is global and if something is configured for vxlan then it will be affected here also

Bridge	CVLAN	SVLAN	BVLAN	Port	MAC Address	FWD	Time-out
3	1			xe2/1	cc37.ab97.37d8	1	300
3	5			xe11/1	0000.11bc.5dec	1	300
3	10			xe2/1	0000.2d50.205c	1	300

Bridge3#show vlan all bridge 3

Bridge	VLAN ID	Name	State	H/W Status	Member ports
					(u)-Untagged, (t)-Tagged
3	1	default	ACTIVE	Success	xe1/1(u) xe2/1(u) xe11/1(u)
3	5	VLAN0005	ACTIVE	Success	xe1/1(t) xe11/1(t)
3	10	VLAN0010	ACTIVE	Success	xe1/1(t) xe2/1(t)

Bridge3#show bridge

Ageout time is global and if something is configured for vxlan then it will be affected here also

Bridge	CVLAN	SVLAN	BVLAN	Port	MAC Address	FWD	Time-out
3	1			xe2/1	cc37.ab97.37d8	1	300
3	5			xe11/1	0000.11bc.5dec	1	300
3	10			xe2/1	0000.2d50.205c	1	300

Bridge3#



## CHAPTER 16 VLAN Cross-Connect (XC)

### Overview

VLAN cross connect creates a L2 bridge between two given endpoints on the same device. Once configured, every packets arriving at one of the endpoints with specific VLAN tag will be sent to another endpoint directly. In current implementation it matches VLAN tag as per configuration in device. If device is configured to match single tag then only outer most tagged will be matched whether packet is double tagged. If device is configured to match double tag then outer tag as well as inner tag will match If the packet is double tagged.

Note:

1. End point or source point could be a physical (Native Ethernet) port or logical port (po, vlan etc).
2. Same Vlan ID cannot be used in 2 cross connects.
3. Different type of L2, L3 and subscriber services are supported over cross.
4. The XC implementation will forward all packets and MAC address learning is disabled.

### Topology

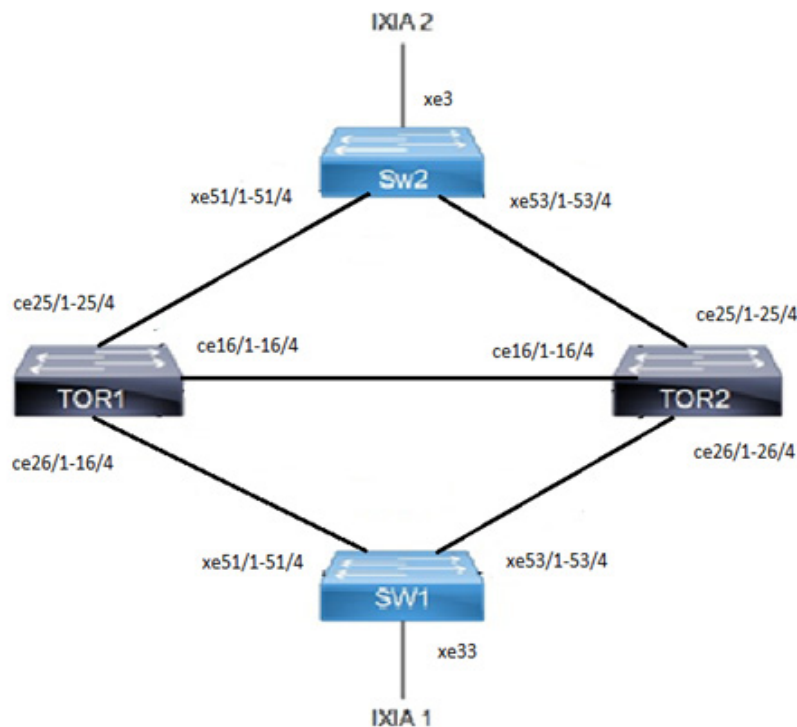

Figure 16-30: Cross-connect topology

---

## Configuration - Single-tagged VLAN

### TOR1

#configure terminal	Enter Configure mode.
(config)#interface ce25/1	Enter Interface mode
(config-if)#switchport	Configure interface as a layer 2 port
(config-if)#commit	Commit candidate configuration to be running configuration
(config-if)#exit	Exit interface mode
(config)#interface ce16/1	Enter Interface mode
(config-if)#switchport	Configure interface as a layer 2 port
(config-if)#commit	Commit candidate configuration to be running configuration
(config-if)#exit	Exit interface mode
(config)#cross-connect VC1	Create cross-connect (XC)
(config-XC)# vlan ep1 ce25/1 ep2 ce16/1	Add Endpoints to XC
(config-VXC)# outer-vlan 100	Outer-vlanId associated with the XC
(config-VXC)#commit	Commit candidate configuration to be running configuration
(config-VXC)#end	Return to privilege mode

### TOR2

#configure terminal	Enter Configure mode.
(config)#interface ce16/1	Enter Interface mode
(config-if)#switchport	Configure interface as a layer 2 port
(config-if)#commit	Commit candidate configuration to be running configuration
(config-if)#exit	Exit interface mode
(config)#interface ce26/1	Enter Interface mode
(config-if)#switchport	Configure interface as a layer 2 port
(config-if)#commit	Commit candidate configuration to be running configuration
(config-if)#exit	Exit interface mode
(config)#cross-connect VC1	Create cross-connect (XC)
(config-XC)# vlan ep1 ce16/1 ep2 ce26/1	Add Endpoints to XC
(config-VXC)# outer-vlan 100	Outer-vlanId associated with the XC
(config-VXC)#commit	Commit candidate configuration to be running configuration
(config-VXC)#end	Return to privilege mode

**SW2**

#configure terminal	Enter Configure mode.
(config)#bridge 1 protocol mstp	Add a bridge (1) to the multiple spanning tree table
(config)#vlan database	Enter the VLAN configuration mode
(config-vlan)#vlan 100 bridge 1 state enable	Enable the state of VLAN 100 on bridge 1. Specifying an enable state allows forwarding of frames over VLAN 100 on bridge 1
(config-vlan)#commit	Commit candidate configuration to be running configuration
(config-vlan)#exit	Exit the VLAN configuration mode
(config)#interface xe51/1	Enter Interface mode
(config-if)#switchport	Configure interface as a layer 2 port
(config-if)#bridge-group 1	Associating the interface to bridge-group 1
(config-if)#switchport mode trunk	set the switching characteristics of the Layer 2 interface
(config-if)#switchport trunk allowed vlan all	Allow all VLANs to transmit and receive through the interface
(config-if)#commit	Commit candidate configuration to be running configuration
(config-if)#exit	Exit interface mode
(config)#interface xe3	Enter Interface mode
(config-if)#switchport	Configure interface as a layer 2 port
(config-if)#bridge-group 1	Associating the interface to bridge-group 1
(config-if)#switchport mode trunk	set the switching characteristics of the Layer 2 interface
(config-if)#switchport trunk allowed vlan all	Allow all VLANs to transmit and receive through the interface
(config-if)#commit	Commit candidate configuration to be running configuration
(config-if)#exit	Exit interface mode

**SW1**

#configure terminal	Enter Configure mode.
(config)#bridge 1 protocol mstp	Add a bridge (1) to the multiple spanning tree table
(config)#vlan database	Enter the VLAN configuration mode
(config-vlan)#vlan 100 bridge 1 state enable	Enable the state of VLAN 100 on bridge 1. Specifying an enable state allows forwarding of frames over VLAN 100 on bridge 1
(config-if)#commit	Commit candidate configuration to be running configuration
(config-if)#exit	Exit the VLAN configuration mode
(config)#interface xe53/1	Enter Interface mode
(config-if)#switchport	Configure interface as a layer 2 port
(config-if)#bridge-group 1	Associating the interface to bridge-group 1
(config-if)#switchport mode trunk	set the switching characteristics of the Layer 2 interface
(config-if)#switchport trunk allowed vlan all	Allow all VLANs to transmit and receive through the interface
(config-if)#commit	Commit candidate configuration to be running configuration
(config-if)#exit	Exit interface mode

## VLAN Cross-Connect (XC)

---

(config)#interface xe33	Enter Interface mode
(config-if)#switchport	Configure interface as a layer 2 port
(config-if)#bridge-group 1	Associating the interface to bridge-group 1
(config-if)#switchport mode trunk	set the switching characteristics of the Layer 2 interface
(config-if)#switchport trunk allowed vlan all	Allow all VLANs to transmit and receive through the interface
(config-if)#commit	Commit candidate configuration to be running configuration
(config-if)#exit	Exit interface mode

---

---

## Validation

### TOR1

```
#show cross-connect
Cross-connect name : VC1
EP1:ce25/1          EP2:ce16/1          Admin Status:UP          OperStatus:UP
=====
+
| EP  | OVID  | IVID  | Rx packets | Rx bytes  | Tx packets | Tx bytes  |
+=====
+
| EP1 |100   | -     | 6572258    | 9858387000 | 0          | 0          |
| EP2 |100   | -     | 0           | 0           | 6572224    | 9858336000 |
+=====
+
Cross-connect summary Total XC      : 1
Admin Up      : 1
Admin Down    : 0
Total Rules   : 1
```

### TOR2

```
#show cross-connect
Cross-connect name : VC1
EP1:ce16/1          EP2:ce26/1          Admin Status:UP          OperStatus:UP
=====
+
| EP  | OVID  | IVID  | Rx packets | Rx bytes  | Tx packets | Tx bytes  |
+=====
+
| EP1 |100   | -     | 616588     | 924882000  | 0          | 0          |
| EP2 |100   | -     | 0           | 0           | 618615     | 927922500  |
+=====
+
Cross-connect summary Total XC      : 1
Admin Up      : 1
Admin Down    : 0
Total Rules   : 1
```

---

## Double-tagged VLAN

### TOR1

#configure terminal	Enter Configure mode.
(config)#interface ce25/1	Enter Interface mode
(config-if)#switchport	Configure interface as a layer 2 port
(config-if)#commit	Commit candidate configuration to be running configuration
(config-if)#exit	Exit interface mode
(config)#interface ce16/1	Enter Interface mode
(config-if)#switchport	Configure interface as a layer 2 port
(config-if)#commit	Commit candidate configuration to be running configuration
(config-if)#exit	Exit interface mode
(config)#cross-connect VC2	Create cross-connect (XC)
(config-XC)# vlan ep1 ce25/1 ep2 ce16/1	Add Endpoints to XC
(config-VXC)# outer-vlan 200-300 inner-vlan 20-30	Outer-vlanId and Inner-vlanId with range associated with the XC
(config-VXC)#commit	Commit candidate configuration to be running configuration
(config-VXC)#end	Return to privilege mode

### TOR2

#configure terminal	Enter Configure mode.
(config)#interface ce16/1	Enter Interface mode
(config-if)#switchport	Configure interface as a layer 2 port
(config-if)#commit	Commit candidate configuration to be running configuration
(config-if)#exit	Exit interface mode
(config)#interface ce26/1	Enter Interface mode
(config-if)#switchport	Configure interface as a layer 2 port
(config-if)#commit	Commit candidate configuration to be running configuration
(config-if)#exit	Exit interface mode
(config)#cross-connect VC2	Create cross-connect (XC)
(config-XC)# vlan ep1 ce16/1 ep2 ce26/1	Add Endpoints to XC
(config-VXC)# outer-vlan 200-300 inner-vlan 20-30	Outer-vlanId and Inner-vlanId with range associated with the XC
(config-VXC)#commit	Commit candidate configuration to be running configuration
(config-VXC)#end	Return to privilege mode

**SW2**

#configure terminal	Enter Configure mode.
(config)#bridge 1 protocol mstp	Add a bridge (1) to the multiple spanning tree table
(config)#vlan database	Enter the VLAN configuration mode
(config-vlan)#vlan 200-300 bridge 1 state enable	Enable the state of VLANs 200-300 on bridge 1. Specifying an enable state allows forwarding of frames over VLANs 200-300 on bridge 1
(config-vlan)#commit	Commit candidate configuration to be running configuration
(config-vlan)#exit	Exit the VLAN configuration mode
(config)#interface xe51/1	Enter Interface mode
(config-if)#switchport	Configure interface as a layer 2 port
(config-if)#bridge-group 1	Associating the interface to bridge-group 1
(config-if)#switchport mode trunk	set the switching characteristics of the Layer 2 interface
(config-if)#switchport trunk allowed vlan all	Allow all VLANs to transmit and receive through the interface
(config-if)#commit	Commit candidate configuration to be running configuration
(config-if)#exit	Exit interface mode
(config)#interface xe3	Enter Interface mode
(config-if)#switchport	Configure interface as a layer 2 port
(config-if)#bridge-group 1	Associating the interface to bridge-group 1
(config-if)#switchport mode trunk	set the switching characteristics of the Layer 2 interface
(config-if)#switchport trunk allowed vlan all	Allow all VLANs to transmit and receive through the interface
(config-if)#commit	Commit candidate configuration to be running configuration
(config-if)#exit	Exit interface mode



**SW1**

#configure terminal	Enter Configure mode.
(config)#bridge 1 protocol mstp	Add a bridge (1) to the multiple spanning tree table
(config)#vlan database	Enter the VLAN configuration mode
(config-vlan)#vlan 200-300 bridge 1 state enable	Enable the state of VLANs 200-300 on bridge 1. Specifying an enable state allows forwarding of frames over VLANs 200-300 on bridge 1
(config-vlan)#commit	Commit candidate configuration to be running configuration
(config-vlan)#exit	Exit the VLAN configuration mode
(config)#interface xe53/1	Enter Interface mode
(config-if)#switchport	Configure interface as a layer 2 port
(config-if)#bridge-group 1	Associating the interface to bridge-group 1
(config-if)#switchport mode trunk	Set the switching characteristics of the Layer 2 interface
(config-if)#switchport trunk allowed vlan all	Allow all VLANs to transmit and receive through the interface
(config-if)#commit	Commit candidate configuration to be running configuration
(config-if)#exit	Exit nterface mode
(config)#interface xe33	Enter Interface mode
(config-if)#no shutdown	Bring interface up
(config-if)#switchport	Configure interface as a layer 2 port
(config-if)#bridge-group 1	Associating the interface to bridge-group 1
(config-if)#switchport mode trunk	Set the switching characteristics of the Layer 2 interface
(config-if)#switchport trunk allowed vlan all	Allow all VLANs to transmit and receive through the interface
(config-if)#commit	Commit candidate configuration to be running configuration
(config-if)#exit	Exit interface mode

**Validation****TOR1**

```
#show cross-connect
Cross-connect name : VC2
EP1:ce25/1          EP2:ce16/1          Admin Status:UP          OperStatus:UP
=====
+
| EP  | OVID      | IVID      | Rx packets | Rx bytes  | Tx packets | Tx bytes  |
+=====
+
| EP1 | 200-300  | 20-30     | 442089    | 663133500 | 0          | 0         |
| EP2 | 200-300  | 20-30     | 0         | 0         | 444123    | 666184500 |
+=====
+
Cross-connect summary
Total XC      : 1
```

## VLAN Cross-Connect (XC)

---

Admin Up : 1  
Admin Down : 0  
Total Rules : 1

### TOR2

#show cross-connect

Cross-connect name : VC2

EP1:ce16/1                      EP2:ce26/1                      Admin Status:UP                      OperStatus:UP

```
=====
```

EP	OVID	IVID	Rx packets	Rx bytes	Tx packets	Tx bytes
EP1	200-300	20-30	267607	401410500	0	0
EP2	200-300	20-30	0	0	269640	404460000

```
=====
```

Cross-connect summary

Total XC : 1  
Admin Up : 1  
Admin Down : 0  
Total Rules : 1

## CHAPTER 17 MAC Authentication Bypass

MAC Authentication Bypass (MAB) is used for a non-authenticating device (a device without an 802.1X supplicant running on it) connecting to a network with 802.1X enabled. Since there is no supplicant to answer the EAP identity requests from the authenticator (switch, wireless controller, etc.) the authenticator will generate the authentication request for the endpoint using the endpoint's MAC address as the username/password for the Access-Request message.

Note: Multicast address is not accepted for host address of radius-server.

### Topology

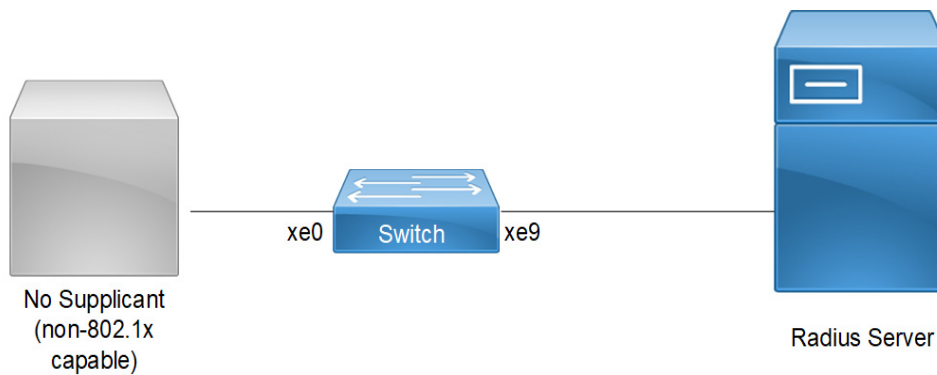

Figure 17-31: MAB Topology

### Configuration

#### Switch Configuration for MAC Authentication Bypass (MAB)

Switch#configure terminal	Enter configure mode
Switch(config)#bridge 1 protocol ieee vlan-bridge	Create bridge 1
OcNOS(config)#commit	Commit candidate configuration to be running configuration
Switch(config)#port-security disable	Disable port security
Switch(config)#dot1x system-auth-ctrl	Enable dot1x authentication globally
Switch(config)#auth-mac system-auth-ctrl	Enable MAC authentication bypass globally
Switch(config)#radius-server dot1x host 10.1.1.1 key 0 testing123	Specify the host IP and key with string name between radius server and client.
Switch(config)#commit	Commit transaction
Switch(config)#interface xe0	Configure interface xe0
Switch(config-if)#switchport	Enable switch port on interface.
Switch(config-if)#bridge-group 1	Associate bridge to an interface.
Switch(config-if)#switchport mode access	Configure port as access
Switch(config-if)#dot1x port-control auto	Enable authentication (via Radius) on port (xe0)
Switch(config-if)#dot1x mac-auth-bypass enable	Enable MAC authentication bypass on interface

## MAC Authentication Bypass

---

OcNOS(config)#commit	Commit candidate configuration to be running configuration
Switch(config)#interface xe9	Configure interface xe9
Switch(config-if)#ip address 10.1.1.2/24	Set the IP address on interface xe9
Switch(config-if)#commit	Commit transaction
Switch(config-if)#end	Exit config mode.

---

## Validation

### Verify MAB on Switch

```
Switch#show mab all
Global MAC Authentication Enabled
  RADIUS server address: 10.1.1.1:1812
  Next radius message id: 4
  RADIUS client address: not configured
```

```
MAB info for interface xe0
  Dot1x timer: Expired
  MAB Authentication Enabled
  Supplicant name: 00:07:E9:A5:3D:FA
  Status: MAC Authorized
  Last rejected MAC:
```

---

## Configuration

### MAC Authentication Configuration

Switch#configure terminal	Enter configure mode
Switch(config)#bridge 1 protocol ieee vlan-bridge	Create bridge 1
Switch(config)#port-security disable	Disable port security
Switch(config)#dot1x system-auth-ctrl	Enable dot1x authentication globally
Switch(config)#auth-mac system-auth-ctrl	Enable MAC authentication bypass globally
Switch(config)#radius-server dot1x host 10.1.1.1 key 0 testing123	Specify the host IP and key with string name between radius server and client.
Switch(config)#commit	Commit transaction
Switch(config)#interface xe0	Configure interface xe0
Switch(config-if)#switchport	Enable switch port on interface.
Switch(config-if)#bridge-group 1	Associate bridge to an interface.
Switch(config-if)#switchport mode access	Configure port as access
Switch(config-if)#auth-mac enable	Enable MAC authentication on interface
OcNOS(config)#commit	Commit candidate configuration to be running configuration
Switch(config)#interface xe9	Configure interface xe9
Switch(config-if)#ip address 10.1.1.2/24	Set the IP address on interface xe9

---

---

Switch(config-if)#commit	Commit transaction
Switch(config-if)#end	Exit config mode.

---

Note: When AUTH-MAC is enabled on the interface MAC-AUTH bypass cannot be enabled and vice-versa.

---

## Validation

### Verify MAB on Switch

```
Switch#show mab all
Global MAC Authentication Enabled
  RADIUS server address: 10.1.1.1:1812
  Next radius message id: 9
  RADIUS client address: not configured
```

```
MAB info for interface xe0
  Dot1x timer: Expired
  MAB Authentication Disabled
  Supplicant name: 00:07:E9:A5:3D:FA
  Status: MAC Authorized
  Last rejected MAC: 00:07:E9:A5:4E:25
```



## CHAPTER 18 Unidirectional Link Detection Configuration

This chapter shows a complete configuration to enable UDLD in a simple network topology.

### Overview

The purpose of Unidirectional Link Detection protocol (UDLD) is to monitor the physical links and detect when a unidirectional link exists. Upon detection user can either block the port or notify the link status based on the network administrator's configuration.

UDLD works in two different modes:

- Normal mode
- Aggressive mode

### Topology

Figure 18-32 shows the topology of the UDLD configuration.

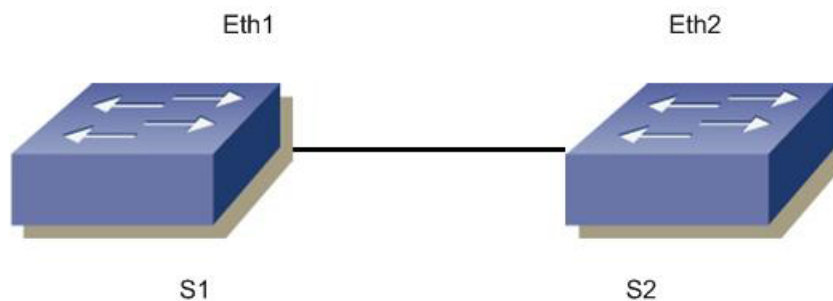

Figure 18-32: UDLD Configuration

#### S1

#configure terminal	Enter configure mode
(config)#udld enable	Enable UDLD globally
(config)#udld message-time 7	Configure message time for UDLD packets
(config)#interface eth1	Enter interface mode
(config-if)#switchport	Configure the interface as switch port
(config-if)#udld state enable	Enable UDLD on the interface
(config-if)#udld mode normal	Configure udld mode as normal or aggressive
(config-if)#commit	Commit config.
(config-if)#exit	Exit from the interface mode

#### S2

#configure terminal	Enter configure mode.
(config)#udld enable	Enable UDLD globally.
(config)#udld message-time 7	Configure message time for UDLD packets

## Unidirectional Link Detection Configuration

---

(config)#interface eth2	Enter interface mode
(config-if)#switchport	Configure the interface as switch port.
(config-if)#udld state enable	Enable UDLD on the interface.
(config-if)#udld mode normal	Configure udld mode as normal or aggressive
(config-if)#commit	Commit config.
(config-if)#exit	Exit from the interface mode

### Validation

```
#show udld
UDLD: Enable
Message Interval(sec) : 7
```

Port	UDLD Status	Mode	Link-Status
Eth1	Enable	Normal	Bi-directional
Eth2	Disable	Normal	Unknown
Eth3	Disable	Normal	Unknown
Eth4	Disable	Normal	Unknown
Eth5	Disable	Normal	Unknown
Eth6	Disable	Normal	Unknown

Once the links is made Uni-directional, the output of the command Show udld is as follows:

```
#show udld
UDLD: Enable
Message Interval(sec) : 7
```

Port	UDLD Status	Mode	Link-Status
Eth1	Enable	Normal	Unidirectional
Eth2	Disable	Normal	Unknown
Eth3	Disable	Normal	Unknown
Eth4	Disable	Normal	Unknown
Eth5	Disable	Normal	Unknown
Eth6	Disable	Normal	Unknown

```
#sh running-config
udld Enable
udld message-time 7
```

```
#sh running-config in eth1
!
interface eth1
 switchport
  udld state Enable
```



---

!

```
#sh udld interface eth1
UDLD Status      : Enable
UDLD Mode        : Normal
Link-State       : Unknown
```

For aggressive mode, udld output is as follows:

```
#show udld
  UDLD : Enable
  Message Interval(sec) : 7
```

Port	UDLD Status	Mode	Link-Status
eth1	Enable	Aggressive	Bi-Directional

```
#sh running config
udld Enable
udld message-time 7
```

```
#sh running-config in eth1
  interface eth1
  switchport
  udld mode Aggressive
  udld state Enable
```



# CHAPTER 19 Provider Bridging Configuration

This chapter contains sample provider bridging configurations.

A provider bridged network is a virtual bridged Local Area Network that comprises provider bridges (SVLAN bridges and provider edge bridges) and attached LANs, under the administrative control of a single service provider. Provider bridges interconnect the separate MACs of the IEEE 802 LANs that compose a provider bridged network, relaying frames to provide connectivity between all the LANs that provide customer interfaces for each service instance.

## Single Provider Bridge Configuration

### Topology



Figure 19-33: Single provider bridge configuration

### Configuration

#### SW1 (PEB)

SW1#configure terminal	Enter configuration mode
SW1(config)#bridge 1 protocol provider-rstp edge	Create bridge
SW1(config)#vlan database	Enter VLAN configuration mode
SW1(config-vlan)#vlan 2 type customer bridge 1 state enable	Create customer vlan VLAN 2
SW1(config-vlan)#vlan 200 type service point-point bridge 1 state enable	Create service vlan VLAN200
SW1(config-vlan)#exit	Exit VLAN configuration mode
SW1(config)#cvlan registration table map1 bridge 1	Create cvlan registration table map1
SW1(config-cvlan-registration)#cvlan 2 svlan 200	Map cvlan2 with svlan 200
SW1(config-cvlan-registration)#exit	Exit registration table
SW1(config)#interface eth1	Enter interface configuration mode for eth1
SW1(config-if)#switchport	Configure switchport
SW1(config-if)#bridge-group 1	Associate interface with bridge-group 1
SW1(config-if)#switchport mode customer-edge access	Configure switchport mode customer edge
SW1(config-if)#switchport customer-edge access vlan 2	Associate customer vlan2 with interface

## Provider Bridging Configuration

SW1(config-if)#switchport customer-edge vlan registration map1	Attach registration table map1 with interface
SW1(config-if)#exit	Exit interface mode
SW1(config)#interface eth2	Enter interface configuration mode for eth2
SW1(config-if)#switchport	Make interface as switchport
SW1(config-if)#bridge-group 1	Associate interface with bridge-group 1
SW1(config-if)#switchport mode provider-network	Configure switchport pnp port
SW1(config-if)#switchport provider-network allowed vlan all	Associate all svlan to the port
SW1(config-if)#exit	Exit interface configuration mode
SW1(config)#commit	Commit the transaction.

### SW2 (PB)

SW2#configure terminal	Enter configuration mode
SW2(config)#bridge 1 protocol provider-rstp	Create provider bridge
SW2(config)#vlan database	Enter VLAN configuration mode
SW2(config-vlan)#vlan 200 type service point-point bridge 1 state enable	Create service vlan VLAN200
SW2(config-vlan)#exit	Exit VLAN configuration mode
SW2(config)#interface eth1	Enter interface configuration mode for eth1
SW2(config-if)#switchport	Make interface as switchport
SW2(config-if)#bridge-group 1	Associate interface with bridge-group 1
SW2(config-if)#switchport mode provider-network	Configure switchport pnp port
SW2(config-if)#switchport provider-network allowed vlan all	Associate all svlan to the port
SW2(config-if)#exit	Exit interface configuration mode
SW2(config)#interface eth2	Enter interface configuration mode for eth2
SW2(config-if)#switchport	Make interface as switchport
SW2(config-if)#bridge-group 1	Associate interface with bridge-group 1
SW2(config-if)#switchport mode provider-network	Configure switchport pnp port
SW2(config-if)#switchport provider-network allowed vlan all	Associate all svlan to the port
SW2(config-if)#exit	Exit interface configuration mode
SW2(config)#commit	Commit the transaction.

### SW3 (PEB)

SW3#configure terminal	Enter configuration mode
SW3(config)#bridge 1 protocol provider-rstp edge	Create bridge
SW3(config)#vlan database	Enter VLAN configuration mode

SW3(config-vlan)#vlan 2 type customer bridge 1 state enable	Create customer vlan VLAN 2
SW3(config-vlan)#vlan 200 type service point-point bridge 1 state enable	Create service vlan VLAN200
SW3(config-vlan)#exit	Exit VLAN configuration mode
SW3(config)#cvlan registration table map1 bridge 1	Create cvlan registration table map1
SW3(config-cvlan-registration)#cvlan 2 svlan 200	Map cvlan2 with svlan 200
SW3(config-cvlan-registration)#exit	Exit registration table
SW3(config)#interface eth1	Enter interface configuration mode for eth1
SW3(config-if)#switchport	Configure switchport
SW3(config-if)#bridge-group 1	Associate interface with bridge-group 1
SW3(config-if)#switchport mode customer-edge access	Configure switchport mode customer edge
SW3(config-if)#switchport customer-edge access vlan 2	Associate customer vlan2 with interface
SW3(config-if)#switchport customer-edge vlan registration map1	Attach registration table map1 with interface
SW3(config-if)#exit	Exit interface mode
SW3(config)#interface eth2	Enter interface configuration mode for eth2
SW3(config-if)#switchport	Make interface as switchport
SW3(config-if)#bridge-group 1	Associate interface with bridge-group 1
SW3(config-if)#switchport mode provider-network	Configure switchport pnp port
SW3(config-if)#switchport provider-network allowed vlan all	Associate all svlan to the port
SW3(config-if)#exit	Exit interface configuration mode
SW3(config)#commit	Commit the transaction.

## Validation

SW3#sh br  
 bridge 1 is running on provider-rstp edge  
 Ageout time is global and if something is configured for vxlan then it will be affected here also

Bridge	CVLAN	SVLAN	BVLAN	Port	MAC Address	FWD	Time-out
1		200		eth1	0000.0000.0f00	1	300
1		200		eth2	0001.0000.0800	1	300

SW1#sh br  
 bridge 1 is running on provider-rstp edge  
 Ageout time is global and if something is configured for vxlan then it will be affected here also

Bridge	CVLAN	SVLAN	BVLAN	Port	MAC Address	FWD	Time-out
1		200		eth2	0000.0000.0f00	1	300

## Provider Bridging Configuration

```
1          200          eth1          0001.0000.0800    1    300
```

```
SW1#sh cvlan registration table
```

```
Bridge          Table Name      Port List
```

```
=====
```

```
1          map1          eth1
```

```
CVLAN ID      SVLAN ID
```

```
=====
```

```
2          200
```

---

## Two Provider Bridge Configuration

---

### Topology

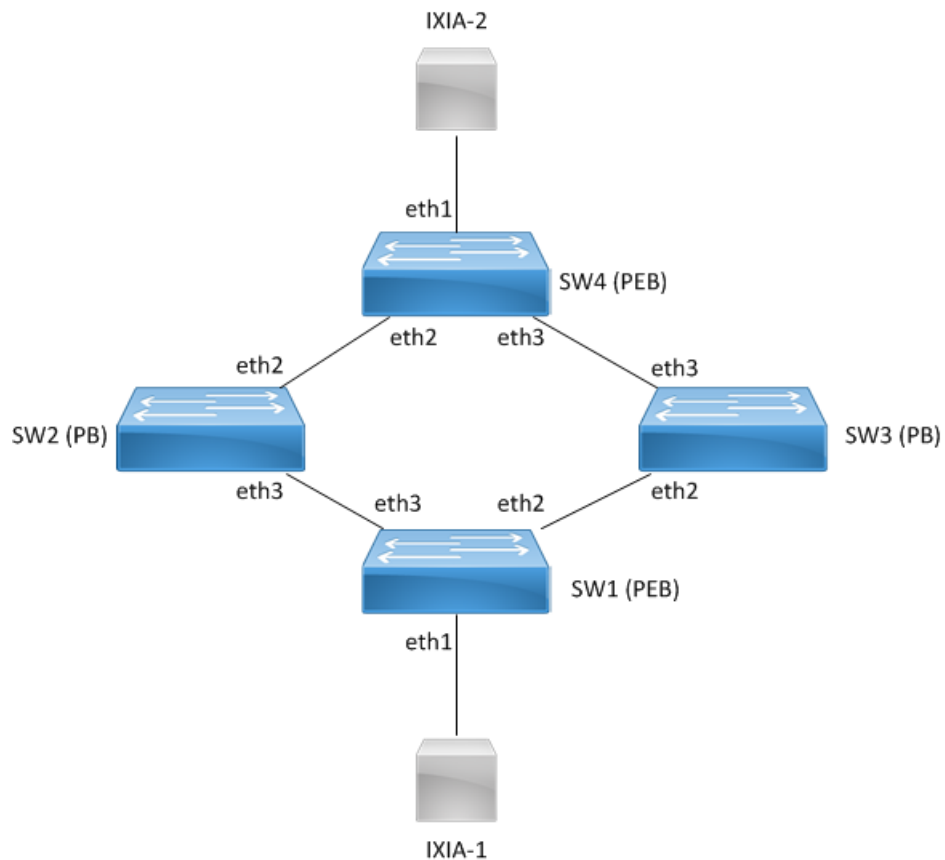

Figure 19-34: Two provider bridge configuration

## Configuration

### SW1 (PEB)

SW1#configure terminal	Enter configuration mode
SW1(config)#bridge 1 protocol provider-rstp edge	Create bridge
SW1(config)#vlan database	Enter VLAN configuration mode
SW1(config-vlan)#vlan 2 type customer bridge 1 state enable	Create customer vlan VLAN 2
SW1(config-vlan)#vlan 200 type service point-point bridge 1 state enable	Create service vlan VLAN200
SW1(config-vlan)#exit	Exit VLAN configuration mode
SW1(config)#cvlan registration table map1 bridge 1	Create cvlan registration table map1
SW1(config-cvlan-registration)#cvlan 2 svlan 200	Map cvlan2 with svlan 200
SW1(config-cvlan-registration)#exit	Exit registration table
SW1(config)#interface eth1	Enter interface configuration mode for eth1
SW1(config-if)#switchport	Configure switchport
SW1(config-if)#bridge-group 1	Associate interface with bridge-group 1
SW1(config-if)#switchport mode customer-edge access	Configure switchport mode customer edge
SW1(config-if)#switchport customer-edge access vlan 2	Associate customer vlan2 with interface
SW1(config-if)#switchport customer-edge vlan registration map1	Attach registration table map1 with interface
SW1(config-if)#exit	Exit interface mode
SW1(config)#interface eth2	Enter interface configuration mode for eth2
SW1(config-if)#switchport	Make interface as switchport
SW1(config-if)#bridge-group 1	Associate interface with bridge-group 1
SW1(config-if)#switchport mode provider-network	Configure switchport pnp port
SW1(config-if)#switchport provider-network allowed vlan all	Associate all svlan to the port
SW1(config-if)#exit	Exit interface mode
SW1(config)#interface eth3	Enter interface configuration mode for eth2
SW1(config-if)#switchport	Make interface as switchport
SW1(config-if)#bridge-group 1	Associate interface with bridge-group 1
SW1(config-if)#switchport mode provider-network	Configure switchport pnp port
SW1(config-if)#switchport provider-network allowed vlan all	Associate all svlan to the port
SW1(config-if)#exit	Exit interface configuration mode
SW1(config)#commit	Commit the transaction.

## SW2 (PB)

SW2#configure terminal	Enter configuration mode
SW2(config)#bridge 1 protocol provider-rstp	Create provider bridge
SW2(config)#vlan database	Enter VLAN configuration mode
SW2(config-vlan)#vlan 200 type service point-point bridge 1 state enable	Create service vlan VLAN200
SW2(config-vlan)#exit	Exit VLAN configuration mode
SW2(config)#interface eth3	Enter interface configuration mode for eth1
SW2(config-if)#switchport	Make interface as switchport
SW2(config-if)#bridge-group 1	Associate interface with bridge-group 1
SW2(config-if)#switchport mode provider-network	Configure switchport pnp port
SW2(config-if)#switchport provider-network allowed vlan all	Associate all svlan to the port
SW2(config-if)#exit	Exit interface configuration mode
SW2(config)#interface eth2	Enter interface configuration mode for eth2
SW2(config-if)#switchport	Make interface as switchport
SW2(config-if)#bridge-group 1	Associate interface with bridge-group 1
SW2(config-if)#switchport mode provider-network	Configure switchport pnp port
SW2(config-if)#switchport provider-network allowed vlan all	Associate all svlan to the port
SW2(config-if)#exit	Exit interface configuration mode
SW2(config)#commit	Commit the transaction.

## SW3 (PB)

SW3#configure terminal	Enter configuration mode
SW3(config)#bridge 1 protocol provider-rstp	Create provider bridge
SW3(config)#vlan database	Enter VLAN configuration mode
SW3(config-vlan)#vlan 200 type service point-point bridge 1 state enable	Create service vlan VLAN200
SW3(config-vlan)#exit	Exit VLAN configuration mode
SW3(config)#interface eth3	Enter interface configuration mode for eth1
SW3(config-if)#switchport	Make interface as switchport
SW3(config-if)#bridge-group 1	Associate interface with bridge-group 1
SW3(config-if)#switchport mode provider-network	Configure switchport pnp port
SW3(config-if)#switchport provider-network allowed vlan all	Associate all svlan to the port
SW3(config-if)#exit	Exit interface configuration mode
SW3(config)#interface eth2	Enter interface configuration mode for eth2
SW3(config-if)#switchport	Make interface as switchport



SW3(config-if)#bridge-group 1	Associate interface with bridge-group 1
SW3(config-if)#switchport mode provider-network	Configure switchport pnp port
SW3(config-if)#switchport provider-network allowed vlan all	Associate all svlan to the port
SW3(config-if)#exit	Exit interface configuration mode
SW3(config)#commit	Commit the transaction.

## SW4 (PEB)

SW4#configure terminal	Enter configuration mode
SW4(config)#bridge 1 protocol provider-rstp edge	Create bridge
SW4(config)#vlan database	Enter VLAN configuration mode
SW4(config-vlan)#vlan 2 type customer bridge 1 state enable	Create customer vlan VLAN 2
SW4(config-vlan)#vlan 200 type service point-point bridge 1 state enable	Create service vlan VLAN200
SW4(config-vlan)#exit	Exit VLAN configuration mode
SW4(config)#cvlan registration table map1 bridge 1	Create cvlan registration table map1
SW4(config-cvlan-registration)#cvlan 2 svlan 200	Map cvlan2 with svlan 200
SW4(config-cvlan-registration)#exit	Exit registration table
SW4(config)#interface eth1	Enter interface configuration mode for eth1
SW4(config-if)#switchport	Configure switchport
SW4(config-if)#bridge-group 1	Associate interface with bridge-group 1
SW4(config-if)#switchport mode customer-edge access	Configure switchport mode customer edge
SW4(config-if)#switchport customer-edge access vlan 2	Associate customer vlan2 with interface
SW4(config-if)#switchport customer-edge vlan registration map1	Attach registration table map1 with interface
SW4(config-if)#exit	Exit interface mode
SW4(config)#interface eth2	Enter interface configuration mode for eth2
SW4(config-if)#switchport	Make interface as switchport
SW4(config-if)#bridge-group 1	Associate interface with bridge-group 1
SW4(config-if)#switchport mode provider-network	Configure switchport pnp port
SW4(config-if)#switchport provider-network allowed vlan all	Associate all svlan to the port
SW4(config-if)#interface eth3	Enter interface configuration mode for eth2
SW4(config-if)#switchport	Make interface as switchport
SW4(config-if)#bridge-group 1	Associate interface with bridge-group 1
SW4(config-if)#switchport mode provider-network	Configure switchport pnp port

## Provider Bridging Configuration

SW4(config-if)#switchport provider-network allowed vlan all	Associate all svlan to the port
SW4(config-if)#exit	Exit interface configuration mode
SW4(config)#commit	Commit the transaction.

## Validation

SW4#sh br

bridge 1 is running on provider-rstp edge

Ageout time is global and if something is configured for vxlan then it will be affected here also

Bridge	CVLAN	SVLAN	BVLAN	Port	MAC Address	FWD	Time-out
1		200		eth1	0000.0000.0a00	1	300
1		200		eth2	0001.0000.0b00	1	300

SW1#sh br

bridge 1 is running on provider-rstp edge

Ageout time is global and if something is configured for vxlan then it will be affected here also

Bridge	CVLAN	SVLAN	BVLAN	Port	MAC Address	FWD	Time-out
1		200		eth1	0000.0000.0b00	1	300
1		200		eth3	0001.0000.0a00	1	300

SW1#sh cvlan registration table

Bridge	Table Name	Port List
--------	------------	-----------

=====

1	map1	eth1
---	------	------

CVLAN ID	SVLAN ID
----------	----------

=====

2	200
---	-----

## Layer 2 Protocol Tunneling (L2PT/L2CP Tunneling)

L2CP tunneling provides support for tunneling Control plane frames between CE nodes.

When control frames received at CEP port of PE bridge, predefined multicast address (01-00-C2-CD-CD-D0) is used for tunneling the packets across service provider network. If control packets are customer vlan tagged or untagged, then PE bridge will append corresponding service vlan tag to the control packet as per registration table / vlan translation table mapped to the port and send it across the service provider as a data packet.

When tunneled control packet with multicast address (01-00-C2-CD-CD-D0) received on PNP port, the multicast address is replaced with corresponding control packet multicast address and cvlan/svlan removal or updating is done as per registration table / vlan translation table.

## Topology

Figure 19-35 displays a sample Provider Bridged topology with customer equipment.

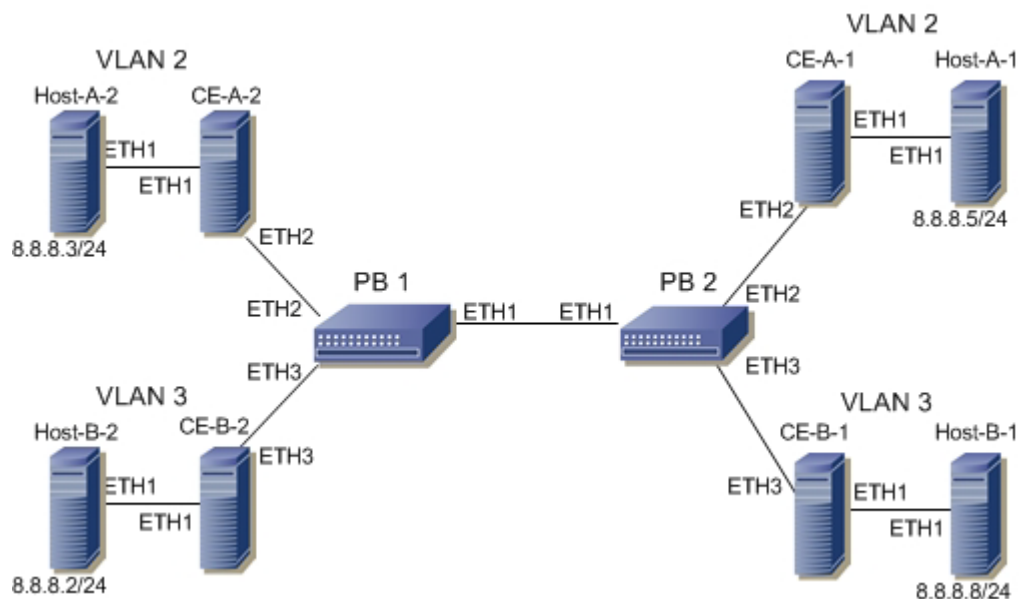

Figure 19-35: Provider Bridging with Customer Equipment Topology

## Configuring the L2PT Protocol on the Interface

The following L2PT protocols are supported:

- EFM: Ethernet first mile (Link OAM)
- ELMI: Ethernet Local Management Interface
- LACP: Link Aggregation Control Protocol
- LLDP: Link Layer Discovery Protocol
- STP: Spanning Tree Protocols

---

## PB1

PB1#configure terminal	Enter Configure mode.
PB1(config)#interface eth2	Enter Interface mode
PB1(config-if)#l2protocol stp peer	Configure STP protocol as peer
PB1(config-if)#l2protocol elmi tunnel	Configure Elmi protocol as tunnel
PB1(config-if)#l2protocol lldp tunnel	Configure LLDP protocol as tunnel
PB1(config-if)#l2protocol lacp discard	Configure LACP protocol as discard
PB1(config-if)#l2protocol efm discard	Configure EFM protocol as discard
PB1(config-if)#exit	Exit of the interface
PB1(config)#commit	Commit the transaction.

---

## Validation

```
PB1#show l2protocol processing interface eth2
```

Bridge	Interface Name	Protocol	Processing Status
=====	=====	=====	=====
1	eth2	stp	Peer
1	eth2	gmrp	Peer
1	eth2	gvrp	Peer
1	eth2	mrrp	Peer
1	eth2	mvrp	Peer
1	eth2	lacp	Discard
1	eth2	lldp	Tunnel
1	eth2	efm	Discard
1	eth2	elmi	Tunnel
1	eth2	ptp	Peer

## Provider Bridging with VLAN Translation

This is a sample configurations to verify functionality to support provider-bridging feature with extended SVLAN translation as below:

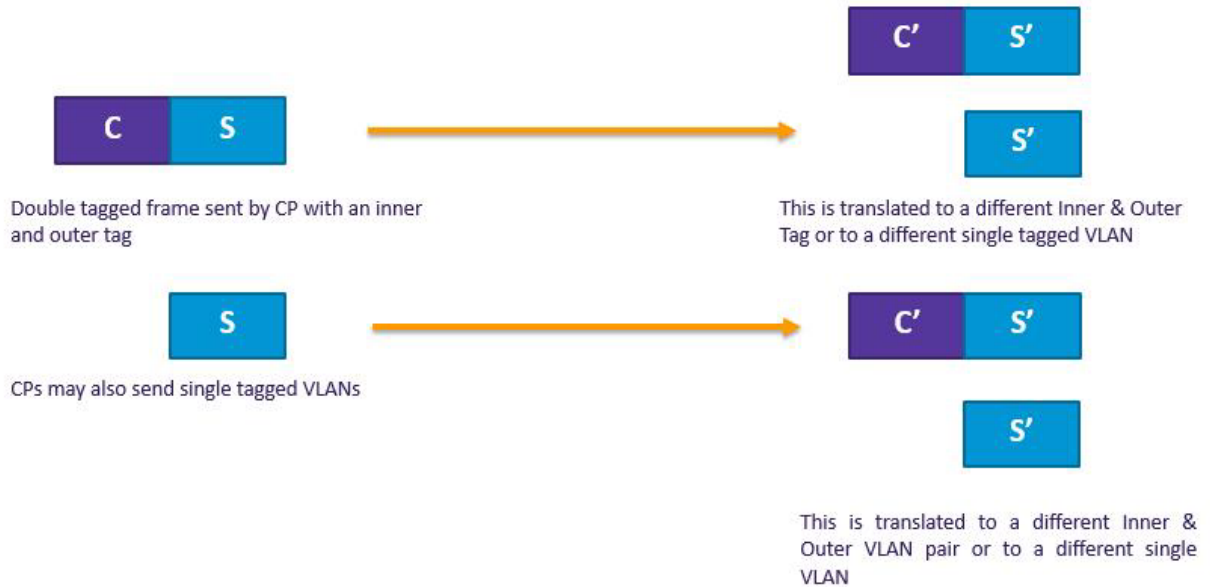

## Topology

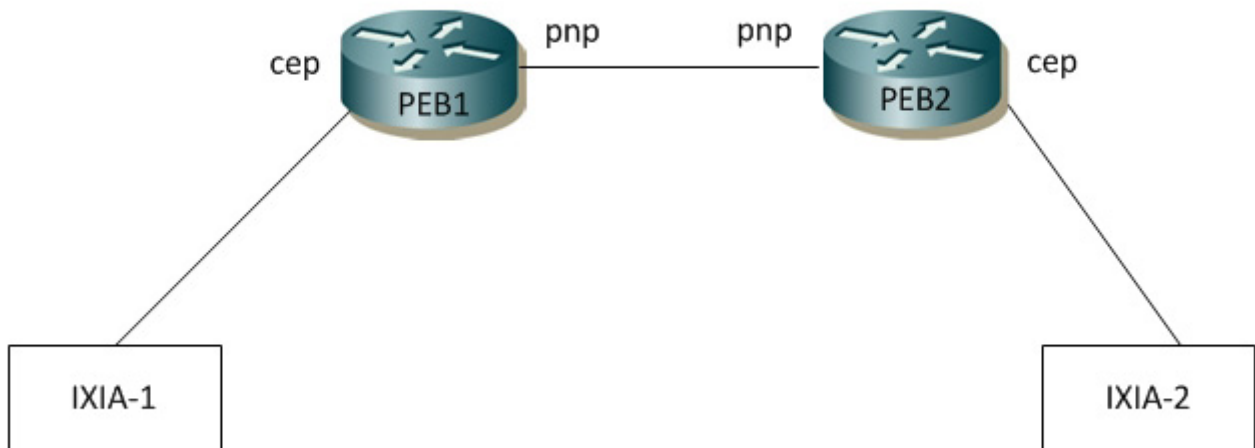

Figure 19-36: Provider Bridging with VLAN Translation Topology

## PEB1

### Bridge Configuration

#configure terminal	Enter configure mode.
(config)#bridge 1 protocol provider-rstp edge	Enter Configure bridge type as provider-RSTP edge bridge
(config)#exit	Exit configure mode.
(config)#commit	Commit the transaction.

### VLAN Configuration

#configure terminal	Enter configure mode.
(config)#vlan database	Enter VLAN database
(config-vlan)# vlan 2-500 type customer bridge 1 state enable	Configure customer VLANs on bridge 1
(config-vlan)#vlan 501-1005 type service point-point bridge 1 state enable	Configure service VLANs on bridge 1
(config-vlan)#commit	Commit the transaction.
(config-vlan)#end	Exit VLAN database and configure mode.

### CVLAN Registration Table Configuration

#configure terminal	Enter configure mode.
(config)#cvlan registration table map1 bridge 1	Configure CVLAN registration table as map1
(config-cvlan-registration)#cvlan 2 svlan 1000	Map CVLAN to SVLAN
(config-cvlan-registration)#cvlan 3 svlan 1005	Map CVLAN to SVLAN
(config-cvlan-registration)#commit	Commit the transaction.
(config-cvlan-registration)#end	End the CVLAN registration mode

### CEP Port Configuration

#configure terminal	Enter configure mode.
(config)#interface ge3	Enter the interface mode
(config-if)#switchport	Configure switchport
(config-if)#bridge-group 1	Attach port to bridge
(config-if)#switchport mode customer-edge hybrid	Configure port as customer-edge hybrid port
(config-if)#switchport customer-edge hybrid allowed vlan all	Add all VLANs configured above to this CEP port
(config-if)#switchport customer-edge vlan registration map1	Attach the Map1 to CEP port

(config-if)#commit	Commit the transaction.
(config-if)#end	Exit interface and configure mode.

### PNP Port Configuration

#configure terminal	Enter configure mode.
(config)#interface ge9	Enter the interface mode
(config-if)#switchport	Configure switchport
(config-if)#bridge-group 1	Attach port to bridge
(config-if)#switchport mode provider-network	Configure port as Provider Network Port (PNP)
(config-if)#switchport provider-network allowed vlan all	Add all VLANs configured above to this PNP port
(config-if)#commit	Commit the configuration
(config-if)#end	Exit interface and configure mode.

## PEB2

### Bridge Configuration

#configure terminal	Enter configure mode.
(config)# bridge 1 protocol provider-rstp edge	Enter configure bridge type as provider-RSTP edge bridge
(config)#commit	Commit the configuration
(config)#exit	Exit configure mode.

### VLAN Configuration

#configure terminal	Enter configure mode.
(config)#vlan database	Enter VLAN database
(config-vlan)#vlan 2-500 type customer bridge 1 state enable	Configure customer VLANs on bridge 1
(config-vlan)#vlan 501-1005 typeservice point-point bridge 1 state enable	Configure service VLANs on bridge 1
(config-vlan)#commit	Commit the configuration
(config-vlan)#end	Exit VLAN database and configure mode.

### CVLAN Registration Table Configuration

#configure terminal	Enter configure mode.
(config)#cvlan registration table map1 bridge 1	Configure CVLAN registration table as map1
(config-cvlan-registration)#cvlan 2 svlan 1000	Map CVLAN to SVLAN
(config-cvlan-registration)#cvlan 3 svlan 1005	Map CVLAN to SVLAN

## Provider Bridging Configuration

---

(config-cvlan-registration)#commit	Commit the configuration
(config-cvlan-registration)#end	End the CVLAN registration mode

---

## CEP Port Configuration

#configure terminal	Enter configure mode.
(config)#interface ge3	Enter the interface mode
(config-if)#switchport	Configure switchport
(config-if)#bridge-group 1	Attach port to bridge
(config-if)#switchport mode customer-edge hybrid	Configure port as customer-edge hybrid port
(config-if)#switchport customer-edge hybrid allowed vlan all	Add all VLANs configured above to this CEP port
(config-if)#switchport customer-edge vlan registration map1	Attach the Map1 to CEP port
(config-if)#commit	Commit the configuration
(config-if)#end	Exit interface and configure mode.

---

## PNP Port Configuration

#configure terminal	Enter configure mode.
(config)#interface ge9	Enter the interface mode
(config-if)#switchport	Configure switchport
(config-if)#bridge-group 1	Attach port to bridge
(config-if)#switchport mode provider-network	Configure port as Provider Network Port (PNP)
(config-if)#switchport provider-network allowed vlan all	Add all VLANs configured above to this PNP port
(config-if)#commit	Commit the configuration
(config-if)#end	Exit interface and configure mode.

---

## Translation Cases

### Case1 - (C S - C' S')

#### Configuration on PEB2

#configure terminal	Enter configure mode.
(config)#interface ge9	Enter the interface mode
(config-if)#switchport provider-network vlan translation cvlan 2 svlan 1000 cvlan 3 svlan 1005	Translate CVLAN and SVLAN to new CVLAN and new SVLAN on PNP port

---



## Validation for Case 1

When tagged traffic with CVLAN 2 is sent from IXIA-1 to IXIA-2 with both CTAG and STAG entering provider network and gets translated to new CVLAN and SVLAN as per Case1.

```
PEB2#show bridge
```

Bridge	CVLAN	SVLAN	BVLAN	Port	MAC Address	FWD	Time-out
1		1		ge27	1402.ec1c.3144	1	300
1		1000		ge9	6400.6a1e.d9a5	1	300
1		1005		ge9	0000.0500.0400	1	300
1		1005		ge9	6400.6a1e.d9a5	1	300

New SVLAN 1005 is observed on PEB2 after translation. Also, captured packets on CEP show new CVLAN 3.

When tagged traffic for CVLAN 3 is sent from IXIA-2 to IXIA-1

```
PEB1#show bridge
```

Bridge	CVLAN	SVLAN	BVLAN	Port	MAC Address	FWD	Time-out
1		1		ge9	74e6.e2af.598b	1	300
1		1000		ge3	0000.0500.0400	1	300
1		1000		ge9	0000.0500.0700	1	300

When traffic is reversed and traffic has both new CVLAN 3 and SVLAN 1005 on provider network from IXIA-2, translation to old CVLAN 2 and SVLAN 1000 happens. Also, captured packets have CVLAN as 2.

## Case2 - (C S - S')

### Configuration on PEB2

#### CVLAN Registration Table Configuration

#configure terminal	Enter configure mode.
(config)#cvlan registration table map1 bridge 1	Configure CVLAN registration table as map1
(config-cvlan-registration)#cvlan 2 svlan 1000	Map CVLAN to SVLAN
(config-cvlan-registration)#cvlan 3 svlan 1005 untagged-pep	Map CVLAN to SVLAN
(config-cvlan-registration)#commit	Commit the configuration
(config-cvlan-registration)#end	End the CVLAN registration mode

#### CEP Port Configuration

#configure terminal	Enter configure mode.
(config)#interface ge3	Enter the interface mode
(config-if)#switchport customer-edge hybrid vlan 3	Allow access VLAN 3 configured above to this CEP port
(config-if)#switchport customer-edge hybrid allowed vlan add 2-3	Allow other VLANs configured to this CEP port
(config-if)#switchport customer-edge vlan registration map1	Attach the Map1 to CEP port

## Provider Bridging Configuration

(config-if)#commit	Commit the configuration
(config-if)#end	Exit interface and configure mode.

## PNP Port Configuration

#configure terminal	Enter configure mode.
(config)#interface ge9	Enter the interface mode
(config-if)#no switchport provider-network vlan translation cvlan 2 svlan 1000	Unconfigure Translation Case1 from PNP port
(config-if)#switchport provider-network vlan translation cvlan 2 svlan 1000 svlan 1005	Configure Translation Case2 on PNP port
(config-if)#commit	Commit the configuration
(config-if)#end	Exit interface and configure mode.

## Validation for Case 2

When tagged traffic with CVLAN 2 is sent from IXIA-1 to IXIA-2 with both CTAG and STAG entering provider network and translated to new SVLAN as per Case2.

```
PEB2#show bridge
Bridge      CVLAN  SVLAN  BVLAN  Port          MAC Address          FWD  Time-out
-----+-----+-----+-----+-----+-----+-----+-----+
1           1      1005   1      ge27          1402.ec1c.3144       1    300
1           1      1005   1      ge9           0000.0500.0400       1    300
```

New SVLAN 1005 is observed on PEB2 after translation. At CEP port connected to IXIA-2, untagged traffic should be received.

When tagged traffic for CVLAN 3 is sent from IXIA-2 to IXIA-1.

```
PEB1#show bridge
Bridge      CVLAN  SVLAN  BVLAN  Port          MAC Address          FWD  Time-out
-----+-----+-----+-----+-----+-----+-----+
1           1      1000   1      ge9           74e6.e2af.598b       1    300
1           1      1000   1      ge3           0000.0500.0400       1    300
1           1      1000   1      ge9           0000.0500.0700       1    300
```

When traffic is reversed and traffic has both new CVLAN 3 and SVLAN 1005 from IXIA-2, translation to old CVLAN 2 and SVLAN 1000 happens. Also, captured packets have CVLAN as 2.

## Case3 - (S - S')

### Configuration on PEB1

#### CVLAN Registration Table Configuration

#configure terminal	Enter configure mode.
(config)#cvlan registration table map1 bridge 1	Configure CVLAN registration table as map1
(config-cvlan-registration)#cvlan 2 svlan 1000	Map CVLAN to SVLAN

(config-cvlan-registration)#cvlan 3 svlan 1005	Map CVLAN to SVLAN
(config-cvlan-registration)#commit	Commit the configuration
(config-cvlan-registration)#end	End the CVLAN registration mode

### CEP Port Configuration

#configure terminal	Enter configure mode.
(config)#interface ge3	Enter the interface mode
(config-if)#switchport customer-edge hybrid vlan 2	Allow access VLAN 2 configured above to this CEP port
(config-if)#switchport customer-edge hybrid allowed vlan add 2-3	Allow other VLANs configured to this CEP port
(config-if)#switchport customer-edge vlan registration map1	Attach the Map1 to CEP port
(config-if)#commit	Commit the configuration
(config-if)#end	Exit interface and configure mode.

### Configuration on PEB2

#### CEP Port Configuration (should be configured as PNP in this case)

#configure terminal	Enter configure mode.
(config)#interface ge3	Enter the interface mode
(config-if)#switchport	Configure switchport
(config-if)#switchport mode provider-network	Configure port as Provider Network Port (PNP)
(config-if)#switchport provider-network allowed vlan all	Add all VLANs configured above to this PNP port
(config-if)#commit	Commit the configuration
(config-if)#end	Exit interface and configure mode.

### PNP Port Configuration

#configure terminal	Enter configure mode.
(config)#interface ge9	Enter the interface mode
(config-if)#no switchport provider-network vlan translation cvlan 2 svlan 1000	Unconfigure Translation Case2 from PNP port
(config-if)#switchport provider-network vlan translation svlan 1000 svlan 1005	Configure Translation Case3 on PNP port
(config-if)#commit	Commit the configuration
(config-if)#end	Exit interface and configure mode.

### Validation for Case 3

When tagged traffic with CVLAN 2 is sent from IXIA-1 to IXIA-2 with only STAG entering provider network and translation happens to new SVLAN as per Case3.

## Provider Bridging Configuration

```
PEB2#show bridge
Bridge      CVLAN  SVLAN  BVLAN  Port      MAC Address      FWD  Time-out
-----+-----+-----+-----+-----+-----+-----+-----+
1           1      1      ge27   1402.ec1c.3144  1      300
1           1      1000   ge9    0000.0500.0400  1      300
1           1      1000   ge9    6400.6a1e.d9a5  1      300
```

New SVLAN 7 is observed on PEB2 At PNP port connected to IXIA-2.

When double tagged traffic of CVLAN 2 and SVLAN 1005 is sent from IXIA-2 to IXIA-1:

```
PEB1#show bridge
Bridge      CVLAN  SVLAN  BVLAN  Port      MAC Address      FWD  Time-out
-----+-----+-----+-----+-----+-----+-----+
1           1      1      ge9    74e6.e2af.598b  1      300
1           1      1005   ge3    0000.0500.0400  1      300
1           1      1000   ge9    0000.0500.0700  1      300
```

Here we get a tagged traffic of CVLAN 2 when the captured at IXIA-1.

### Case4 - (S - C' S')

#### Configuration on PEB1

##### CVLAN Registration Table Configuration

#configure terminal	Enter configure mode.
(config)#cvlan registration table map1 bridge 1	Configure CVLAN registration table as map1
(config-cvlan-registration)#cvlan 2 svlan 1000 untagged-pep	Map CVLAN to SVLAN
(config-cvlan-registration)#cvlan 3 svlan 1005	Map CVLAN to SVLAN
(config-cvlan-registration)#commit	Commit the configuration
(config-cvlan-registration)#end	End the CVLAN registration mode

##### CEP Port Configuration

#configure terminal	Enter configure mode.
(config)#interface ge3	Enter the interface mode
(config-if)#switchport customer-edge hybrid vlan 2	Allow access VLAN 2 configured above to this CEP port
(config-if)#switchport customer-edge hybrid allowed vlan add 2-3	Allow other VLANs configured to this CEP port
(config-if)#switchport customer-edge vlan registration map1	Attach the Map1 to CEP port
(config-if)#commit	Commit the configuration
(config-if)#end	Exit interface and configure mode.

## Configuration on PEB2

### CEP Port Configuration (should be configured as PNP in this case)

#configure terminal	Enter configure mode.
(config)#interface ge3	Enter the interface mode
(config-if)#switchport	Configure switchport
(config-if)#bridge-group 1	Attach port to bridge
(config-if)#switchport mode provider-network	Configure port as Provider Network Port (PNP)
(config-if)#switchport provider-network allowed vlan all	Add all VLANs configured above to this PNP port
(config-if)#commit	Commit the configuration
(config-if)#end	Exit interface and configure mode.

### PNP Port Configuration

#configure terminal	Enter configure mode.
(config)#interface ge9	Enter the interface mode
(config-if)#no switchport provider-network vlan translation svlan 1000 svlan 1005	Unconfigure Translation Case2 from PNP port
(config-if)#switchport provider-network vlan translation svlan 1000 cvlan 3 svlan 1005	Configure Translation Case3 on PNP port
(config-if)#commit	Commit the configuration
(config-if)#end	Exit interface and configure mode.

## Validation for Case 4

When tagged traffic with CVLAN 2 is sent from IXIA-1 to IXIA-2 enters provider network and translation happens to new CVLAN and new SVLAN as per Case4.

```
PEB2#show bridge
Bridge      CVLAN  SVLAN  BVLAN  Port      MAC Address      FWD  Time-out
-----+-----+-----+-----+-----+-----+-----+-----+
1           1      1      ge27    1402.ec1c.3144  1      300
1           1      1000   ge9     0000.0500.0400  1      300
1           1      1000   ge9     6400.6a1e.d9a5  1      300
```

When you observe the traffic received in IXIA-2, you can observe that new CVLAN 3 and SVLAN 1005 tags can be seen. Here the VLAN 2 will be a data packet.

When tagged traffic for CVLAN 3 and SVLAN 1005 is sent from IXIA-2 to IXIA-1:

```
PEB1#show bridge
Bridge      CVLAN  SVLAN  BVLAN  Port      MAC Address      FWD  Time-out
-----+-----+-----+-----+-----+-----+-----+-----+

```

1	1000	ge3	0000.0500.0400	1	300
1	1005	ge9	0000.0500.0700	1	300

When you observe, in PEB1 the packets will be dropped at the CEP port since only a single S tagged packets is obtained in the PNP.

### Case5 - (C - C' S')

#### Configuration on PEB1

##### CVLAN Registration Table Configuration

#configure terminal	Enter configure mode.
(config)#cvlan registration table map1 bridge 1	Configure CVLAN registration table as map1
(config-cvlan-registration)#cvlan 2 cvlan 3 svlan 500	Map CVLAN to C'VLAN and SVLAN
(config-cvlan-registration)#cvlan 5 cvlan 6 svlan 1500	Map CVLAN to C'VLAN and SVLAN
(config-cvlan-registration)#commit	Commit the configuration
(config-cvlan-registration)#end	End the CVLAN registration mode

##### CEP Port Configuration

#configure terminal	Enter configure mode.
(config)#interface ge3	Enter the interface mode
(config-if)#switchport	Configure switchport
(config-if)#bridge-group 1	Attach port to bridge
(config-if)#switchport mode customer-edge hybrid	Configure port as customer-edge hybrid port
(config-if)#switchport customer-edge hybrid allowed vlan all	Allow other VLANs configured to this CEP port
(config-if)#switchport customer-edge vlan registration map1	Attach the Map1 to CEP port
(config-if)#commit	Commit the configuration
(config-if)#end	Exit interface and configure mode.

#### Configuration on PEB2

##### CEP Port Configuration (should be configured as PNP in this case)

#configure terminal	Enter configure mode.
(config)#interface ge3	Enter the interface mode
(config-if)#switchport	Configure switchport
(config-if)#bridge-group 1	Attach port to bridge
(config-if)#switchport mode provider-network	Configure port as Provider Network Port (PNP)
(config-if)#switchport provider-network allowed vlan all	Add all VLANs configured above to this PNP port

(config-if)#commit	Commit the configuration
(config-if)#end	Exit interface and configure mode.

### PNP Port Configuration

#configure terminal	Enter configure mode.
(config)#interface ge9	Enter the interface mode
(config-if)#switchport	Configure switchport
(config-if)#bridge-group 1	Attach port to bridge
(config-if)#switchport mode provider-network	Configure port as Provider Network Port (PNP)
(config-if)#switchport provider-network allowed vlan all	Add all VLANs configured above to this PNP port
(config-if)#commit	Commit the configuration
(config-if)#end	Exit interface and configure mode.

### Validation for Case 5

When tagged traffic with CVLAN 2 is sent from IXIA-1 to IXIA-2 with both CTAG and STAG entering provider network and gets translated to new CVLAN and SVLAN as per Case1.

```
PEB2#show bridge
```

Bridge	CVLAN	SVLAN	BVLAN	Port	MAC Address	FWD	Time-out
1		1		ge27	1402.ec1c.3144	1	300
1		1000		ge9	0000.0500.0400	1	300
1		1000		ge9	6400.6a1e.d9a5	1	300

When the packet is captured at PNP port of PEB2 CVLAN of 3 and SVLAN of 4 is seen.

When tagged traffic for CVLAN 6 and SVLAN 1005 is sent from IXIA-2 to IXIA-1:

```
PEB1#show bridge
```

Bridge	CVLAN	SVLAN	BVLAN	Port	MAC Address	FWD	Time-out
1		1		ge9	74e6.e2af.598b	1	300
1		1000		ge3	0000.0500.0400	1	300
1		1005		ge9	0000.0500.0700	1	300

When traffic is reversed and traffic has both new CVLAN 6 and SVLAN 1005 on provider network from IXIA-2, translation to CVLAN 5 and SVLAN 1005 happens. Also, captured packets have CVLAN as 2 based on the entry in the cvlan registration table.

## Switchport ethertype

### Bridge Configuration (for 0x88a8)

#### Configuration on PEB1

#### CVLAN Registration Table Configuration

#configure terminal	Enter configure mode.
(config)#cvlan registration table map1 bridge 1	Configure CVLAN registration table as map1
(config-cvlan-registration)#cvlan 2 svlan 1000	Map CVLAN to SVLAN
(config-cvlan-registration)#cvlan 3 svlan 1005	Map CVLAN to SVLAN
(config-cvlan-registration)#commit	Commit the configuration
(config-cvlan-registration)#end	End the CVLAN registration mode

#### Configuration on PEB2

### CEP Port Configuration (should be configured as PNP in this case)

#### CEP Port Configuration

#configure terminal	Enter configure mode.
(config)#interface ge3	Enter the interface mode
(config-if)#switchport	Configure switchport
(config-if)#bridge-group 1	Attach port to bridge
(config-if)#switchport mode provider-network	Configure port as Provider Network Port (PNP)
(config-if)#switchport provider-network allowed vlan all	Add all VLANs configured above to this PNP port
(config-if)#commit	Commit the configuration
(config-if)#end	Exit interface and configure mode.

#### PNP Port Configuration

#configure terminal	Enter configure mode.
(config)#interface ge9	Enter the interface mode
(config-if)#switchport	Configure switchport
(config-if)#bridge-group 1	Attach port to bridge
(config-if)#switchport mode provider-network	Configure port as Provider Network Port (PNP)
(config-if)#switchport provider-network vlan allowed vlan all	Add all VLANs configured above to this PNP port
(config-if)#switchport dot1ad ethertype 0x88a8	Change the TPID of the SVLAN to 0x88a8



<code>(config-if) #commit</code>	Commit the configuration
<code>(config-if) #end</code>	Exit interface and configure mode.

## Validation for Switchport ethertype

To validate, send tagged traffic of VLAN 2 from IXIA-1.

Now at eth9 of PB2, capture the packets through IXIA-2 and verify that the traffic is received with double tag.

If the 2 tags CVLAN tag 2 will have the TPID of 0x8100 and SVLAN tag 4 will have a TPID of 0x88a8.

## Provider Bridging QoS Configuration

This chapter contains sample provider bridging configurations for QoS.

### Scenario: 1 Traffic flow from CEP to PNP

#### Topology



Figure 19-37: Provider Bridging with QoS Topology

#### Bridge Configuration

<code>#configure terminal</code>	Enter configure mode.
<code>(config)# bridge 1 protocol provider-rstp edge</code>	Enter configure bridge type as provider-RSTP edge bridge
<code>(config) #commit</code>	Commit the configuration
<code>(config) #exit</code>	Exit configure mode.

#### VLAN Configuration

<code>#configure terminal</code>	Enter configure mode.
<code>(config) #vlan database</code>	Enter VLAN database

## Provider Bridging Configuration

(config-vlan)#vlan 2-500 type customer bridge 1 state enable	Configure customer VLANs on bridge 1
(config-vlan)#vlan 501-1005 type service point-point bridge 1 state enable	Configure service VLANs on bridge 1
(config-vlan)#commit	Commit the configuration
(config-vlan)#end	Exit VLAN database and configure mode.

## CVLAN Registration Table Configuration

#configure terminal	Enter configure mode.
(config)#cvlan registration table map1 bridge 1	Configure CVLAN registration table as map1
(config-cvlan-registration)#cvlan 2 svlan 501	Map CVLAN to SVLAN
(config-cvlan-registration)#commit	Commit the configuration
(config-cvlan-registration)#end	End the CVLAN registration mode

## CEP Port Configuration

#configure terminal	Enter configure mode.
(config)#interface xe2	Enter the interface mode
(config-if)#switchport	Configure switchport
(config-if)#bridge-group 1	Attach port to bridge
(config-if)#switchport mode customer-edge hybrid	Configure port as customer-edge hybrid port
(config-if)#switchport customer-edge hybrid allowed vlan all	Add all VLANs configured above to this CEP port
(config-if)#switchport customer-edge vlan registration map1	Attach the Map1 to CEP port
(config-if)#commit	Commit the configuration
(config-if)#end	Exit interface and configure mode.

## PNP Port Configuration

#configure terminal	Enter configure mode.
(config)#interface xe3	Enter the interface mode
(config-if)#switchport	Configure switchport
(config-if)#bridge-group 1	Attach port to bridge
(config-if)#switchport mode provider-network	Configure port as Provider Network Port (PNP)
(config-if)#switchport provider-network allowed vlan add 501	Add all VLANs configured above to this PNP port
(config-if)#commit	Commit the configuration
(config-if)#end	Exit interface and configure mode.

## QoS Configurations

#configure terminal	Enter configure mode.
(config)#hardware-profile filter qos-ext enable	Enabling Ingress extended QoS group for QoS support with statistics
(config)#qos enable	Enabling QoS
(config)#qos statistics	Enabling QoS statistics
(config)#qos profile cos-to-queue cosq-cust1	Configure QoS map profile
config-ingress-cos-map)#cos 0 queue 1	Configuring the cos value to be mapped to queue
(config-ingress-cos-map)#exit	Exit configure mode.
(config)#qos profile queue-color-to-cos cosq-service1	Configuring profile for queue color to cos map
(config-egress-cos-map)#queue 1 cos 3	Configuring the queue value to be cos remarked.
(config-egress-cos-map)#exit	Exit configure mode
(config)#cvlan registration table map1 bridge 1	Enter CVLAN registration mode
(config-cvlan-registration)#cvlan 2 svlan 501 cos-to-queue cosq-cust1	Map CVLAN to SVLAN with QoS map profile. Eg: when vlan 2 customer traffic with cos 0 value is received, queue will be assigned to 1 based on mapping.
(config-cvlan-registration)#exit	Exit the CVLAN registration mode
(config)#interface xe3	Enter the interface mode
(config-if)#qos map-profile queue-color-to-cos cosq-service1	Map the profile to the PNP port. Eg: when traffic goes out of queue 1, cos value on service vlan header will be modified to 3 as remarking is enabled on the interface.
(config-if)#qos remark cos enable	Enabling Cos Remark on the Network Interface.
(config-if)#commit	Commit the configuration
(config-if)#end	Exit interface and configure mode.

## Validation for Scenario 1

```
#show cvlan registration table map1
Bridge          Table Name      Port List
=====
1               map1           xe2
```

```
CVLAN ID      T-CVLAN ID      SVLAN ID      Profile Name      Egress remark-
Cos
=====
2             -                501           cosq-cust1        No
```

```
#show qos-profile interface xe2
profile name: default
profile type: cos-to-queue (Ingress)
mapping:
```

INPUT				OUTPUT			
COS	DEI	Queue	Color	COS	DEI	Queue	Color

Provider Bridging Configuration

0	0	0	green		0	1	0	yellow
1	0	1	green		1	1	1	yellow
2	0	2	green		2	1	2	yellow
3	0	3	green		3	1	3	yellow
4	0	4	green		4	1	4	yellow
5	0	5	green		5	1	5	yellow
6	0	6	green		6	1	6	yellow
7	0	7	green		7	1	7	yellow

profile name: default  
 profile type: queue-color-to-cos (Egress)  
 Status: Inactive

mapping:

INPUT			OUTPUT	INPUT			OUTPUT	INPUT		
Queue	Color	COS		Queue	Color	COS		Queue	Color	COS
0	green	0		0	yellow	0		0	red	0
1	green	1		1	yellow	1		1	red	1
2	green	2		2	yellow	2		2	red	2
3	green	3		3	yellow	3		3	red	3
4	green	4		4	yellow	4		4	red	4
5	green	5		5	yellow	5		5	red	5
6	green	6		6	yellow	6		6	red	6
7	green	7		7	yellow	7		7	red	7

#show qos-profile interface xe3  
 profile name: default  
 profile type: cos-to-queue (Ingress)  
 mapping:

INPUT				OUTPUT	INPUT				OUTPUT
COS	DEI	Queue	Color		COS	DEI	Queue	Color	
0	0	0	green		0	1	0	yellow	
1	0	1	green		1	1	1	yellow	
2	0	2	green		2	1	2	yellow	
3	0	3	green		3	1	3	yellow	
4	0	4	green		4	1	4	yellow	
5	0	5	green		5	1	5	yellow	
6	0	6	green		6	1	6	yellow	
7	0	7	green		7	1	7	yellow	

profile name: cosq-service1  
 profile type: queue-color-to-cos (Egress)  
 Status: Active  
 mapping:

INPUT			OUTPUT	INPUT			OUTPUT	INPUT		
Queue	Color	COS		Queue	Color	COS		Queue	Color	COS
0	green	0		0	yellow	0		0	red	0
1	green	1		1	yellow	1		1	red	1
2	green	2		2	yellow	2		2	red	2
3	green	3		3	yellow	3		3	red	3
4	green	4		4	yellow	4		4	red	4
5	green	5		5	yellow	5		5	red	5
6	green	6		6	yellow	6		6	red	6
7	green	7		7	yellow	7		7	red	7

Queue	Color	COS	Queue	Color	COS	Queue	Color	COS
0	green	0	0	yellow	0	0	red	0
1	green	3	1	yellow	3	1	red	3
2	green	2	2	yellow	2	2	red	2
3	green	3	3	yellow	3	3	red	3
4	green	4	4	yellow	4	4	red	4
5	green	5	5	yellow	5	5	red	5
6	green	6	6	yellow	6	6	red	6
7	green	7	7	yellow	7	7	red	7

## Scenario: 2 Traffic flow from PNP to CEP

### Topology



Figure 19-38: Provider Bridging with QoS Topology

### Bridge Configuration

#configure terminal	Enter configure mode.
(config)# bridge 1 protocol provider-rstp edge	Enter configure bridge type as provider-RSTP edge bridge
(config)#commit	Commit the configuration
(config)#exit	Exit configure mode.

### VLAN Configuration

#configure terminal	Enter configure mode.
(config)#vlan database	Enter VLAN database
(config-vlan)#vlan 2-500 type customer bridge 1 state enable	Configure customer VLANs on bridge 1
(config-vlan)#vlan 501-1005 type service point-point bridge 1 state enable	Configure service VLANs on bridge 1

## Provider Bridging Configuration

(config-vlan) #commit	Commit the configuration
(config-vlan) #end	Exit VLAN database and configure mode.

## CVLAN Registration Table Configuration

#configure terminal	Enter configure mode.
(config) #cvlan registration table map1 bridge 1	Configure CVLAN registration table as map1
(config-cvlan-registration) #commit	Commit the configuration
(config-cvlan-registration) #end	End the CVLAN registration mode

## CEP Port Configuration

#configure terminal	Enter configure mode.
(config) #interface xe2	Enter the interface mode
(config-if) #switchport	Configure switchport
(config-if) #bridge-group 1	Attach port to bridge
(config-if) #switchport mode customer-edge hybrid	Configure port as customer-edge hybrid port
(config-if) #switchport customer-edge hybrid allowed vlan all	Add all VLANs configured above to this CEP port
(config-if) #switchport customer-edge vlan registration map1	Attach the Map1 to CEP port
(config-if) #commit	Commit the configuration
(config-if) #end	Exit interface and configure mode.

## PNP Port Configuration

#configure terminal	Enter configure mode.
(config) #interface xe3	Enter the interface mode
(config-if) #switchport	Configure switchport
(config-if) #bridge-group 1	Attach port to bridge
(config-if) #switchport mode provider-network	Configure port as Provider Network Port (PNP)
(config-if) #switchport provider-network allowed vlan add 501	Add all VLANs configured above to this PNP port
(config-if) #commit	Commit the configuration
(config-if) #end	Exit interface and configure mode.

## QoS Configurations

#configure terminal	Enter configure mode.
(config) #hardware-profile filter qos-ext enable	Enabling Ingress extended QoS group for QoS support with statistics
(config) #qos enable	Enabling QoS
(config) #qos statistics	Enabling QoS statistics

(config)#qos profile cos-to-queue cosq-cust1	Configure QoS map profile
config-ingress-cos-map)#cos 2 queue 5	Configuring the cos value to be mapped to queue. Eg: when double tagged traffic with cos 2 for outer vlan is received, queue will be assigned to 5 based on mapping.
(config-ingress-cos-map)#exit	Exit configure mode.
(config)#cvlan registration table map1 bridge 1	Enter CVLAN registration mode
(config-cvlan-registration)#cvlan 2 svlan 501 remark-cos	Map CVLAN to SVLAN with remark cos enabled. Eg: when double tagged traffic with cos 2 for outer vlan is received, queue will be assigned to 5 based on mapping and cos value will be changed to 5 when it goes out of cep port since remark cos is enabled.
(config-cvlan-registration)#cvlan 3 svlan 501 remark-cos	Map CVLAN to SVLAN without remark cos. Eg: when double tagged traffic with cos 2 for outer vlan is received, and cos value will be forwarded as it is when it goes out of cep port since remark cos is not enabled for customer2.
(config-cvlan-registration)#commit	Commit the configuration
(config-cvlan-registration)#end	End the CVLAN registration mode
(config)#configure terminal	Enter configure mode
(config)#interface xe3	Enter the interface mode
(config-if)#qos map-profile cos-to-queue cosq-service	Map the profile to the PNP port
(config-if)#commit	Commit the configuration
(config-if)#end	Exit interface and configure mode

## Validation for Scenario 2

```
#show cvlan registration table map1
Bridge          Table Name      Port List
=====
1               map1            xe2

CVLAN ID        T-CVLAN ID      SVLAN ID        Profile Name     Egress remark-
Cos
=====
2               -                501             N/A              Yes
3               -                501             N/A              No
```

```
#show qos-profile interface xe2
profile name: default
profile type: cos-to-queue (Ingress)
mapping:
```

INPUT				OUTPUT			
COS	DEI	Queue	Color	COS	DEI	Queue	Color
0	0	0	green	0	1	0	yellow
1	0	1	green	1	1	1	yellow
2	0	2	green	2	1	2	yellow
3	0	3	green	3	1	3	yellow

Provider Bridging Configuration

```

4      0      4      green  | 4      1      4      yellow
5      0      5      green  | 5      1      5      yellow
6      0      6      green  | 6      1      6      yellow
7      0      7      green  | 7      1      7      yellow

```

```

profile name: default
profile type: queue-color-to-cos (Egress)
Status: Inactive
mapping:

```

INPUT			OUTPUT	INPUT			OUTPUT	INPUT		
Queue	Color	COS		Queue	Color	COS		Queue	Color	COS
0	green	0		0	yellow	0		0	red	0
1	green	1		1	yellow	1		1	red	1
2	green	2		2	yellow	2		2	red	2
3	green	3		3	yellow	3		3	red	3
4	green	4		4	yellow	4		4	red	4
5	green	5		5	yellow	5		5	red	5
6	green	6		6	yellow	6		6	red	6
7	green	7		7	yellow	7		7	red	7

```

#show qos-profile interface xe3
profile name: cosq-service
profile type: cos-to-queue (Ingress)
mapping:

```

INPUT				OUTPUT	INPUT				OUTPUT
COS	DEI	Queue	Color		COS	DEI	Queue	Color	
0	0	0	green		0	1	0	yellow	
1	0	1	green		1	1	1	yellow	
2	0	5	green		2	1	5	yellow	
3	0	3	green		3	1	3	yellow	
4	0	4	green		4	1	4	yellow	
5	0	5	green		5	1	5	yellow	
6	0	6	green		6	1	6	yellow	
7	0	7	green		7	1	7	yellow	

```

profile name: default
profile type: queue-color-to-cos (Egress)
Status: Inactive
mapping:

```

INPUT			OUTPUT	INPUT			OUTPUT	INPUT		
Queue	Color	COS		Queue	Color	COS		Queue	Color	COS
0	green	0		0	yellow	0		0	red	0
1	green	1		1	yellow	1		1	red	1
2	green	2		2	yellow	2		2	red	2
3	green	3		3	yellow	3		3	red	3
4	green	4		4	yellow	4		4	red	4
5	green	5		5	yellow	5		5	red	5
6	green	6		6	yellow	6		6	red	6
7	green	7		7	yellow	7		7	red	7



---

0	green	0		0	yellow	0		0	red	0
1	green	1		1	yellow	1		1	red	1
2	green	2		2	yellow	2		2	red	2
3	green	3		3	yellow	3		3	red	3
4	green	4		4	yellow	4		4	red	4
5	green	5		5	yellow	5		5	red	5
6	green	6		6	yellow	6		6	red	6
7	green	7		7	yellow	7		7	red	7

---

## Provider Bridging Untagged-pep Configuration

This is a sample configuration to verify functionality to support provider-bridging with untagged-pep feature.

For the below topology configuration,

1. While sending tagged traffic untagged-pep CVLAN 2, it should drop in provider edge bridge.
2. And while sending tagged traffic CVLAN 3 to the provider network, will egress with CVLAN 3 and SVLAN 12 tag and the same CVLAN and SVLAN tag from provider network, will egress with only CVLAN tag
3. And also for untagged traffic to the provider network, will egress with SVLAN 11 tag

---

### Topology

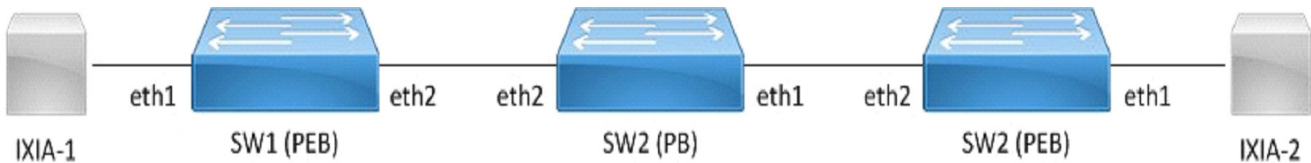

Figure 19-39: provider bridge untagged-pep configuration

---

## Configuration

### SW1 (PEB)

SW1#configure terminal	Enter configuration mode
SW1(config)#bridge 1 protocol provider-rstp edge	Create bridge
SW1(config)#vlan database	Enter VLAN configuration mode
SW1(config-vlan)#vlan 2-10 type customer bridge 1 state enable	Create customer vlan VLAN 2-10
SW1(config-vlan)#vlan 11-15 type service point-point bridge 1 state enable	Create service vlan VLAN 11-15
SW1(config-vlan)#exit	Exit VLAN configuration mode
SW1(config)#cvlan registration table map1 bridge 1	Create cvlan registration table map1
SW1(config-cvlan-registration)#cvlan 2 svlan 11 untagged-pep	Map cvlan2 with svlan 11
SW1(config-cvlan-registration)#cvlan 3 svlan 12	Map cvlan3 with svlan 12
SW1(config-cvlan-registration)#cvlan 4 svlan 14	Map cvlan4 with svlan 14
SW1(config-cvlan-registration)#exit	Exit registration table
SW1(config)#interface eth1	Enter interface configuration mode for eth1
SW1(config-if)#switchport	Configure switchport
SW1(config-if)#bridge-group 1	Associate interface with bridge-group 1
SW1(config-if)#switchport mode customer-edge access	Configure switchport mode customer edge
SW1(config-if)#switchport customer-edge hybrid vlan 2	Associate customer vlan2 with interface
SW1(config-if)#switchport customer-edge hybrid allowed vlan all	Associate all customer vlan with interface
SW1(config-if)#switchport customer-edge vlan registration map1	Attach registration table map1 with interface
SW1(config-if)#exit	Exit interface mode
SW1(config)#interface eth2	Enter interface configuration mode for eth2
SW1(config-if)#switchport	Make interface as switchport
SW1(config-if)#bridge-group 1	Associate interface with bridge-group 1
SW1(config-if)#switchport mode provider-network	Configure switchport pnp port
SW1(config-if)#switchport provider-network allowed vlan all	Associate all svlan to the port
SW1(config-if)#exit	Exit interface configuration mode
SW1(config)#commit	Apply the commit
SW1(config)#end	Exit configuration mode

## SW2 (PB)

SW2#configure terminal	Enter configuration mode
SW2(config)#bridge 1 protocol provider-rstp	Create provider bridge
SW2(config)#vlan database	Enter VLAN configuration mode
SW2(config-vlan)#vlan 2-15 type service point-point bridge 1 state enable	Create service vlan VLAN2-15
SW2(config-vlan)#exit	Exit VLAN configuration mode
SW2(config)#interface eth1	Enter interface configuration mode for eth1
SW2(config-if)#switchport	Make interface as switchport
SW2(config-if)#bridge-group 1	Associate interface with bridge-group 1
SW2(config-if)#switchport mode provider-network	Configure switchport pnp port
SW2(config-if)#switchport provider-network allowed vlan all	Associate all svlan to the port
SW2(config-if)#exit	Exit interface configuration mode
SW2(config)#interface eth2	Enter interface configuration mode for eth2
SW2(config-if)#switchport	Make interface as switchport
SW2(config-if)#bridge-group 1	Associate interface with bridge-group 1
SW2(config-if)#switchport mode provider-network	Configure switchport pnp port
SW2(config-if)#switchport provider-network allowed vlan all	Associate all svlan to the port
SW2(config-if)#exit	Exit interface configuration mode
SW2(config)#commit	Apply the commit
SW2(config)#end	Exit configuration mode

## SW3 (PEB)

SW3#configure terminal	Enter configuration mode
SW3(config)#bridge 1 protocol provider-rstp edge	Create bridge
SW3(config)#vlan database	Enter VLAN configuration mode
SW3(config-vlan)#vlan 2-10 type customer bridge 1 state enable	Create customer vlan VLAN 2-10
SW3(config-vlan)#vlan 11-15 type service point-point bridge 1 state enable	Create service vlan VLAN11-15
SW3(config-vlan)#exit	Exit VLAN configuration mode
SW3(config)#cvlan registration table map1 bridge 1	Create cvlan registration table map1
SW3(config-cvlan-registration)#cvlan 2 svlan 11 untagged-pep	Map cvlan 2 with svlan 11
SW3(config-cvlan-registration)#cvlan 3 svlan 12	Map cvlan 3 with svlan 12
SW3(config-cvlan-registration)#cvlan 4 svlan 14	Map cvlan 4 with svlan 14
SW3(config-cvlan-registration)#exit	Exit registration table

SW3(config)#interface eth1	Enter interface configuration mode for eth1
SW3(config-if)#switchport	Configure switchport
SW3(config-if)#bridge-group 1	Associate interface with bridge-group 1
SW3(config-if)#switchport mode customer-edge access	Configure switchport mode customer edge
SW3(config-if)#switchport customer-edge hybrid vlan 2	Associate customer vlan2 with interface
SW3(config-if)#switchport customer-edge hybrid allowed vlan all	Associate all customer vlan with interface
SW3(config-if)#switchport customer-edge vlan registration map1	Attach registration table map1 with interface
SW3(config-if)#exit	Exit interface mode
SW3(config)#interface eth2	Enter interface configuration mode for eth2
SW3(config-if)#switchport	Make interface as switchport
SW3(config-if)#bridge-group 1	Associate interface with bridge-group 1
SW3(config-if)#switchport mode provider-network	Configure switchport pnp port
SW3(config-if)#switchport provider-network allowed vlan all	Associate all svlan to the port
SW3(config-if)#exit	Exit interface configuration mode
SW3(config)#commit	Apply the commit
SW3(config)#end	Exit configuration mode

## Validation

SW3#sh bridge

bridge 1 is running on provider-rstp edge

Ageout time is global and if something is configured for vxlan then it will be affected here also

Bridge	CVLAN	SVLAN	BVLAN	Port	MAC Address	FWD	Time-out
1	4	14		eth2	0000.0100.0007	1	300

SW1#sh bridge

bridge 1 is running on provider-rstp edge

Ageout time is global and if something is configured for vxlan then it will be affected here also

Bridge	CVLAN	SVLAN	BVLAN	Port	MAC Address	FWD	Time-out
1		14		eth1	0000.0100.0007	1	300

SW1#sh cvlan registration table map1

## Provider Bridging Configuration

---

Bridge	Table Name	Port List
--------	------------	-----------

=====	=====	=====
-------	-------	-------

1	map1	eth1
---	------	------

CVLAN ID	T-CVLAN ID	SVLAN ID	CCOS	SCOS	CCFI	SCFI
=====	=====	=====	=====	=====	=====	=====

3	-	12				
---	---	----	--	--	--	--

2	-	11				
---	---	----	--	--	--	--

4	-	14				
---	---	----	--	--	--	--

## CHAPTER 20 Provider Bridging Configuration (SVLAN)

---

This chapter contains sample provider bridging configurations for Customer-Network Port (CNP).

A provider bridged network is a virtual bridged Local Area Network that comprises provider bridges (SVLAN bridges and provider edge bridges) and attached LANs, under the administrative control of a single service provider. Provider bridges interconnect the separate MACs of the IEEE 802 LANs that compose a provider bridged network, relaying frames to provide connectivity between all the LANs that provide customer interfaces for each service instance.

---

### Customer-Network Port (CNP)

In Q-in-Q, the customer network port is similar to provider network port, which can be present in provider-edge bridge (PEB) or provider bridge core (PB), where it can be directly connected to a dedicated customer network. Only SVLAN ids are configurable on Customer network port and learning and forwarding occurs based on SVLAN.

---

### STAG-based Interface

In this case, the customer will be sending traffic with SVLAN, which will be learnt and forwarded via provider network.

In this example, the xe1 interface allows S-TAG 100-200 and 400 traffic from customer.

```
(config)#interface xe1
(config-if)#switchport
(config-if)#dot1ad ethertype 0x88a8
(config-if)#bridge-group 1
(config-if)#switchport mode customer-network
(config-if)#switchport customer-network allowed vlan add 100-200,400
```

---

### Port-based Interface

In this case, the customer traffic with C-VLAN/untagged, received on interface will be stacked with a customer-network SVLAN ID and will be forwarded via provider network. While egressing out of customer-network port for the default SVLAN, the outer SVLAN id will be stripped and the packet will be sent as C-TAG or untagged to customer device.

In this example, the xe1 interface allows C-TAG/untagged traffic from customers, adding an SVLAN ID 100 before forwarding to the provider network. While egressing out, the SVLAN ID100 will be stripped.

```
(config)#interface xe1
(config-if)#switchport
(config-if)#dot1ad ethertype 0x88a8
(config-if)#bridge-group 1
(config-if)#switchport mode customer-network
(config-if)#switchport customer-network allowed vlan add 100
(config-if)#switchport customer-network vlan 100
```

## Topology



**Figure 20-40: Single provider bridge configuration**

## Configuration

### SW1 (PEB)

SW1#configure terminal	Enter configuration mode
SW1(config)#bridge 1 protocol provider-rstp edge	Create bridge
SW1(config)#vlan database	Enter VLAN configuration mode
SW1(config-vlan)#vlan 100,200 type service point-point bridge 1 state enable	Create service vlan VLAN 100, 200
SW1(config-vlan)#exit	Exit VLAN configuration mode
SW1(config)#interface eth1	Enter interface configuration mode for eth1
SW1(config-if)#switchport	Configure switchport
SW1(config-if)#dot1ad ethertype 0x88a8	Add Provider Bridging Service VLAN tag identifier
SW1(config-if)#switchport mode customer-network	Configure switchport mode for CNP(customer network port)
SW1(config-if)#switchport customer-network allowed vlan add 200	Associate vlan 200 with interface
SW1(config-if)#switchport customer-network vlan 200	Add vlan 200 as default SVLAN-ID for traffic with CVLAN/untagged
SW1(config-if)#exit	Exit interface mode
SW1(config-if)#interface eth2	Enter interface configuration mode for eth2
SW1(config-if)#switchport	Make interface as switchport
SW1(config-if)#bridge-group 1	Associate interface with bridge-group 1
SW1(config-if)#switchport mode provider-network	Configure switchport pnp port
SW1(config-if)#switchport provider-network allowed vlan all	Associate all svlan to the port
SW1(config-if)#commit	Commit the configuration.
SW1(config-if)#exit	Exit interface configuration mode



**SW2 (PB)**

SW2#configure terminal	Enter configuration mode
SW2(config)#bridge 1 protocol provider-rstp	Create provider bridge
SW2(config)#vlan database	Enter VLAN configuration mode
SW2(config-vlan)#vlan 200 type service point-point bridge 1 state enable	Create service vlan VLAN200
SW2(config-vlan)#exit	Exit VLAN configuration mode
SW2(config)#interface eth1	Enter interface configuration mode for eth1
SW2(config-if)#switchport	Make interface as switchport
SW2(config-if)#bridge-group 1	Associate interface with bridge-group 1
SW2(config-if)#switchport mode provider-network	Configure switchport pnp port
SW2(config-if)#switchport provider-network allowed vlan all	Associate all svlan to the port
SW2(config-if)#exit	Exit interface configuration mode
SW2(config-if)#interface eth2	Enter interface configuration mode for eth2
SW2(config-if)#switchport	Make interface as switchport
SW2(config-if)#bridge-group 1	Associate interface with bridge-group 1
SW2(config-if)#switchport mode provider-network	Configure switchport pnp port
SW2(config-if)#switchport provider-network allowed vlan all	Associate all svlan to the port
SW2(config-if)#commit	Commit the configuration.
SW2(config-if)#exit	Exit interface configuration mode

**SW3 (PEB)**

SW3#configure terminal	Enter configuration mode
SW3(config)#bridge 1 protocol provider-rstp edge	Create bridge
SW3(config)#vlan database	Enter VLAN configuration mode
SW3(config-vlan)#vlan 200 type service point-point bridge 1 state enable	Create service vlan VLAN200
SW3(config-vlan)#exit	Exit VLAN configuration mode
SW3(config)#interface eth1	Enter interface configuration mode for eth1
SW3(config-if)#switchport	Configure switchport
SW3(config-if)#dot1ad ethertype 0x88a8	Add Provider Bridging Service VLAN tag identifier
SW3(config-if)#bridge-group 1	Associate interface with bridge-group 1
SW3(config-if)#switchport mode customer-network	Configure switchport CNP port
SW3(config-if)#switchport customer-network allowed vlan add 200	Associate vlan 200 with interface
SW3(config-if)#switchport customer-network vlan 200	Add vlan 200 as default SVLAN-ID for traffic with CVLAN/untagged

## Provider Bridging Configuration (SVLAN)

SW3(config-if)#exit	Exit interface mode
SW3(config-if)#interface eth2	Enter interface configuration mode for eth2
SW3(config-if)#switchport	Make interface as switchport
SW3(config-if)#bridge-group 1	Associate interface with bridge-group 1
SW3(config-if)#switchport mode provider-network	Configure switchport pnp port
SW3(config-if)#switchport provider-network allowed vlan all	Associate all svlan to the port
SW3(config-if)#commit	Commit the configuration.
SW3(config-if)#exit	Exit interface configuration mode

## Validation

```
SW3#show bridge
bridge 1 is running on provider-rstp edge
Ageout time is global and if something is configured for vxlan then it will be affected here also
```

Bridge	CVLAN	SVLAN	BVLAN	Port	MAC Address	FWD	Time-out
1		200		eth1	0000.0000.0f00	1	300
1		200		eth2	0001.0000.0800	1	300

```
SW1#show bridge
bridge 1 is running on provider-rstp edge
Ageout time is global and if something is configured for vxlan then it will be affected here also
```

Bridge	CVLAN	SVLAN	BVLAN	Port	MAC Address	FWD	Time-out
1		200		eth2	0000.0000.0f00	1	300
1		200		eth1	0001.0000.0800	1	300

# CHAPTER 21 MLAG with Provider Bridging Configuration

This chapter contains sample MLAG with Provider bridging configuration.

A provider bridged network is a virtual bridged Local Area Network that comprises provider bridges (SVLAN bridges and provider edge bridges) and attached LANs, under the administrative control of a single service provider. Provider bridges interconnect the separate MACs of the IEEE 802 LANs that compose a provider bridged network, relaying frames to provide connectivity between all the LANs that provide customer interfaces for each service instance.

MLAG (also called DRNI, Distributed Resilient Network Interconnect) expands the concept of link aggregation so that it provides node-level redundancy by allowing two or more nodes to share a common LAG endpoint. MLAG emulates multiple nodes to represent as a single logical node to the remote node running link aggregation. As a result, even if one of the nodes is down there exists a path to reach the destination through the other nodes.

Note: For MLAG with PB, use provider rstp edge bridge on TOR (PEB) nodes and LEAF (PB) node.

## Topology

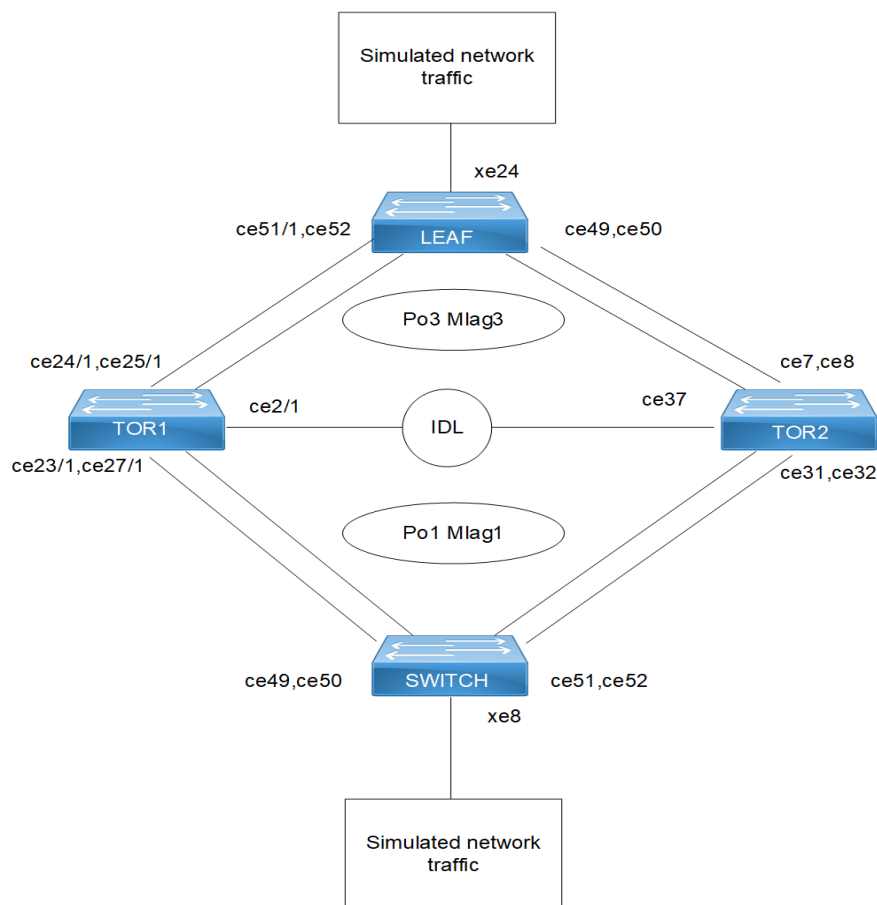

Figure 21-41: MLAG with Provider Bridging

## Configuration

### Switch

SWITCH#configure terminal	Enter configuration mode
SWITCH(config)#bridge 1 protocol rstp vlan-bridge	Configure the rstp vlan bridge
SWITCH(config)#vlan database	Enter VLAN configuration mode
SWITCH(config-vlan)#vlan 2-2000 bridge 1 state enable	Create vlan for bridge
SWITCH(config-vlan)#exit	Exit VLAN configuration mode
SWITCH(config)#interface po1	Enter interface configuration mode for po1
SWITCH(config-if)#switchport	Configure switchport
SWITCH(config-if)#bridge-group 1 spanning-tree disable	Associate interface with bridge-group 1 by disblaing spanning tree
SWITCH(config-if)#switchport mode trunk	Configure switchport mode as trunk
SWITCH(config-if)#switchport trunk allowed vlan all	Associate created vlans to po1 interface
SWITCH(config-if)#exit	Exit from interface mode
SWITCH(config)#interface xe8	Enter interface configuration mode for xe8
SWITCH(config-if)#switchport	Configure switchport
SWITCH(config-if)#bridge-group 1 spanning-tree disable	Associate interface with bridge-group 1 by disblaing spanning tree
SWITCH(config-if)#switchport mode trunk	Configure switchport mode as trunk
SWITCH(config-if)#switchport trunk allowed vlan all	Associate created vlans to xe8 interface
SWITCH(config-if)#exit	Exit from interface mode
SWITCH(config)#interface ce49	Enter interface configuration mode for ce49
SWITCH(config-if)# channel-group 1 mode active	Configure interface as member port for po1- port channel
SWITCH(config-if)#exit	Exit from interface mode
SWITCH(config)#interface ce50	Enter interface configuration mode for ce49
SWITCH(config-if)#channel-group 1 mode active	Configure interface as member port for po1- port channel
SWITCH(config-if)#exit	Exit from interface mode
SWITCH(config)#interface ce51	Enter interface configuration mode for ce49
SWITCH(config-if)#channel-group 1 mode active	Configure interface as member port for po1- port channel
SWITCH(config-if)#exit	Exit from interface mode
SWITCH(config)#interface ce52	Enter interface configuration mode for ce49
SWITCH(config-if)#channel-group 1 mode active	Configure interface as member port for po1- port channel
SWITCH(config-if)#exit	Exit from interface mode

SWITCH(config)#commit	Commit the candidate configuration to the running configuration.
SWITCH(config)#exit	Exit from config mode

**TOR1 (PEB)**

TOR1#configure terminal	Enter configuration mode
TOR1(config)#bridge 1 protocol provider-rstp edge	Create provider rstp edge bridge
TOR1(config)#vlan database	Enter VLAN configuration mode
TOR1(config-vlan)#vlan 2-500 type customer bridge 1 state enable	Create customer vlan VLAN 2-500
TOR1(config-vlan)#vlan 501-1005 type service point-point bridge 1 state enable	Create service vlan VLAN 501-1005
TOR1(config-vlan)#exit	Exit VLAN configuration mode
TOR1(config)#cvlan registration table cvlan100 bridge 1	Create cvlan registration table with name cvlan100
TOR1(config-cvlan-registration)#cvlan 100 svlan 1000	Map cvlan100 with svlan 1000
TOR1(config-cvlan-registration)#exit	Exit registration table
TOR1(config)#hardware-profile filter egress-l2 enable	Enable the hardware-profile filter for egress l2.
TOR1(config)#interface mlag1	Enter interface configuration mode for mlag1
TOR1(config-if)#switchport	Configure switchport
TOR1(config-if)#bridge-group 1 spanning-tree disable	Associate interface with bridge-group 1 and disable spanning-tree
TOR1(config-if)#switchport mode customer-edge trunk	Configure switchport mode customer edge
TOR1(config-if)# switchport customer-edge trunk allowed vlan add 100	Associate customer vlan100 to interface
TOR1(config-if)#switchport customer-edge vlan registration cvlan100	Attach registration table cvlan100 to interface
TOR1(config-if)#mode active-active	Configure mlag mode as active-active
TOR1(config-if)#exit	Exit interface mode
TOR1(config)#interface mlag3	Enter interface configuration mode for mlag3
TOR1(config-if)#switchport	Make interface as switchport
TOR1(config-if)# bridge-group 1 spanning-tree disable	Associate interface with bridge-group 1 and disable spanning-tree
TOR1(config-if)#switchport mode provider-network	Configure switchport pnp port
TOR1(config-if)#switchport provider-network allowed vlan all	Associate all svlan to the port
TOR1(config-if)#mode active-active	Configure mlag mode as active-active
TOR1(config-if)#exit	Exit interface configuration mode
TOR1(config)#interface po1	Enter interface configuration mode for po1
TOR1(config-if)#switchport	Make interface as switchport

## MLAG with Provider Bridging Configuration

TOR1 (config-if) #mlag 1	Associate mlag1 interface to po1
TOR1 (config-if) #exit	Exit interface configuration mode
TOR1 (config) #interface po3	Enter interface configuration mode for po3
TOR1 (config-if) #switchport	Make interface as switchport
TOR1 (config-if) #dot1ad ethertype 0x88a8	Configure TPID with 88a8 to send and receive double tag (Q in Q)
TOR1 (config-if) #mlag 3	Associate mlag3 interface to po3
TOR1 (config-if) #exit	Exit interface configuration mode
TOR1 (config) #interface ce2/1	Enter interface configuration mode for ce2/1 which is an IDL link
TOR1 (config-if) #switchport	Make interface as switchport
TOR1 (config-if) #exit	Exit interface configuration mode
TOR1 (config) #interface ce24/1	Enter interface configuration mode for ce24/1
TOR1 (config-if) #channel-group 3 mode active	Configure interface as member port for po3- port channel
TOR1 (config-if) #exit	Exit interface configuration mode
TOR1 (config) # interface ce25/1	Enter interface configuration mode for ce25/1
TOR1 (config-if) #channel-group 3 mode active	Configure interface as member port for po3- port channel
TOR1 (config-if) #exit	Exit interface configuration mode
TOR1 (config) #interface ce23/1	Enter interface configuration mode for ce23/1
TOR1 (config-if) #channel-group 1 mode active	Configure interface as member port for po1- port channel
TOR1 (config-if) #exit	Exit interface configuration mode
TOR1 (config) #interface ce27/1	Enter interface configuration mode for ce2471
TOR1 (config-if) #channel-group 1 mode active	Configure interface as member port for po1- port channel
TOR1 (config-if) #exit	Exit interface configuration mode
TOR1 (config) #mcec domain configuration	Enter mcec domain configuration mode
TOR1 (config-mcec-domain) #domain-address 2222.3333.4444	Configure domain address for mlag domain
TOR1 (config-mcec-domain) #domain-system-number 1	Configure domain number to identify node in a domain
TOR1 (config-mcec-domain) #intra-domain-link ce2/1	Configure intra domain link between tor nodes mlag domain
TOR1 (config-mcec-domain) #exit	Exit from mcec domain mode
TOR1 (config) #commit	Commit the candidate configuration to the running configuration.
TOR1 (config) #exit	Exit from config mode

## TOR2 (PEB)

TOR2#configure terminal	Enter configuration mode
TOR2 (config) #bridge 1 protocol provider-rstp edge	Create provider rstp edge bridge
TOR2 (config) #vlan database	Enter VLAN configuration mode
TOR2 (config-vlan) #vlan 2-500 type customer bridge 1 state enable	Create customer vlan VLAN 2-500

TOR2(config-vlan)#vlan 501-1005 type service point-point bridge 1 state enable	Create service vlan VLAN 501-1005
TOR2(config-vlan)#exit	Exit VLAN configuration mode
TOR2(config)#cvlan registration table cvlan100 bridge 1	Create cvlan registration table with name cvlan100
TOR2(config-cvlan-registration)#cvlan 100 svlan 1000	Map cvlan100 with svlan 1000
TOR2(config-cvlan-registration)#exit	Exit registration table
TOR2(config)#hardware-profile filter egress-l2 enable	Enable the hardware-profile filter for egress l2.
TOR2(config)#interface mlag1	Enter interface configuration mode for mlag1
TOR2(config-if)#switchport	Configure switchport
TOR2(config-if)#bridge-group 1 spanning-tree disable	Associate interface with bridge-group 1 and disable spanning-tree
TOR2(config-if)#switchport mode customer-edge trunk	Configure switchport mode customer edge
TOR2(config-if)# switchport customer-edge trunk allowed vlan add 100	Associate customer vlan 100 to interface
TOR2(config-if)#switchport customer-edge vlan registration cvlan100	Attach registration table cvlan100 to interface
TOR2(config-if)#mode active-active	Configure mlag mode as active-active
TOR2(config-if)#exit	Exit interface mode
TOR2(config)#interface mlag3	Enter interface configuration mode for mlag3
TOR2(config-if)#switchport	Make interface as switchport
TOR2(config-if)# bridge-group 1 spanning-tree disable	Associate interface with bridge-group 1 and disable spanning-tree
TOR2(config-if)#switchport mode provider-network	Configure switchport pnp port
TOR2(config-if)#switchport provider-network allowed vlan all	Associate all svlan to the port
TOR2(config-if)#mode active-active	Configure mlag mode as active-active
TOR2(config-if)#exit	Exit interface configuration mode
TOR2(config)#interface po1	Enter interface configuration mode for po1
TOR2(config-if)#switchport	Make interface as switchport
TOR2(config-if)#mlag 1	Associate mlag1 interfacce to po1
TOR2(config-if)#exit	Exit interface configuration mode
TOR2(config)#interface po3	Enter interface configuration mode for po3
TOR2(config-if)#switchport	Make interface as switchport
TOR2(config-if)#dot1ad ethertype 0x88a8	Configure TPID with 88a8 to send and receive double tag (Q in Q)
TOR2(config-if)#mlag 3	Associate mlag1 interfacce to po3
TOR2(config-if)#exit	Exit interface configuration mode
TOR2(config)#interface ce37	Enter interface configuration mode for ce2/1 which is an IDL link
TOR2(config-if)#switchport	Make interface as switchport

## MLAG with Provider Bridging Configuration

TOR2 (config-if) #exit	Exit interface configuration mode
TOR2 (config) #interface ce7	Enter interface configuration mode for ce7
TOR2 (config-if) #channel-group 3 mode active	Configure interface as member port for po3- port channel
TOR2 (config-if) #exit	Exit interface configuration mode
TOR2 (config) # interface ce8	Enter interface configuration mode for ce8
TOR2 (config-if) #channel-group 3 mode active	Configure interface as member port for po3- port channel
TOR2 (config-if) #exit	Exit interface configuration mode
TOR2 (config) #interface ce31	Enter interface configuration mode for ce31
TOR2 (config-if) #channel-group 1 mode active	Configure interface as member port for po1- port channel
TOR2 (config-if) #exit	Exit interface configuration mode
TOR2 (config) #interface ce32	Enter interface configuration mode for ce32
TOR2 (config-if) #channel-group 1 mode active	Configure interface as member port for po1- port channel
TOR2 (config-if) #exit	Exit interface configuration mode
TOR2 (config) #mcec domain configuration	Enter mcec domain configuration mode
TOR2 (config-mcec-domain) #domain-address 2222.3333.4444	Configure domain address for mlag domain
TOR2 (config-mcec-domain) #domain-system- number 2	Configure domain number to identify node in a domain
TOR2 (config-mcec-domain) #intra-domain-link ce37	Configure intra domain link between tor nodes mlag domain
TOR2 (config-mcec-domain) #exit	Exit interface configuration mode
TOR2 (config) #commit	Commit the candidate configuration to the running configuration.
TOR2 (config) #exit	Exit interface configuration mode

## LEAF(PB)

LEAF#configure terminal	Enter configuration mode
LEAF (config) # bridge 1 protocol provider- rstp edge	Create provider rstp edge bridge
LEAF (config) #vlan database	Enter VLAN configuration mode
LEAF (config-vlan) #vlan 2-500 type customer bridge 1 state enable	Create customer vlan VLAN 2-500
LEAF (config-vlan) #vlan 501-1005 type service point-point bridge 1 state enable	Create service vlan VLAN 501-1005
LEAF (config-vlan) #exit	Exit VLAN configuration mode
LEAF (config) #interface po3	Enter interface configuration mode for po3
LEAF (config-if) #switchport	Make interface as switchport
LEAF (config-if) #dot1ad ethertype 0x88a8	Configure TPID with 88a8 to send and receive double tag (Q in Q)
LEAF (config-if) #bridge-group 1 spanning-tree disable	Associate interface with bridge-group 1 and disable spanning-tree
LEAF (config-if) #switchport mode provider- network	Configure switchport pnp port



LEAF(config-if)#switchport provider-network allowed vlan all	Associate all svlan to the port
LEAF(config-if)#exit	Exit interface configuration mode
LEAF(config)#interface xe24	Enter interface configuration mode for xe24
LEAF(config-if)#switchport	Make interface as switchport
LEAF(config-if)#dot1ad ethertype 0x88a8	Configure TPID with 88a8 to send and receive double tag (Q in Q)
LEAF(config-if)#bridge-group 1 spanning-tree disable	Associate interface with bridge-group 1 and disable spanning-tree
LEAF(config-if)#switchport mode provider-network	Configure switchport pnp port
LEAF(config-if)#switchport provider-network allowed vlan all	Associate all svlan to the port
LEAF(config-if)#exit	Exit interface configuration mode
LEAF(config)#interface ce49	Enter interface configuration mode for ce49
LEAF(config-if)# channel-group 3 mode active	Configure interface as member port for po3- port channel
LEAF(config-if)#exit	Exit interface configuration mode
LEAF(config)#interface ce50	Enter interface configuration mode for ce50
LEAF(config-if)# channel-group 3 mode active	Configure interface as member port for po3- port channel
LEAF(config-if)#exit	Exit interface configuration mode
LEAF(config)#interface ce51	Enter interface configuration mode for ce51
LEAF(config-if)# channel-group 3 mode active	Configure interface as member port for po3- port channel
LEAF(config-if)#exit	Exit interface configuration mode
LEAF(config)#interface ce52	Enter interface configuration mode for ce52
LEAF(config-if)# channel-group 3 mode active	Configure interface as member port for po3- port channel
LEAF(config-if)#exit	Exit interface configuration mode
LEAF(config)#commit	Commit the candidate configuration to the running configuration.
LEAF(config)#exit	Exit from config mode

## Validation

Validation commands are : show mlag domain summary , show mlag domain details, show ether-channel summary, show bridge, Show mac address-table bridge <bridge-id>, show cvlan registration table bridge <bridge-id>

For below show mac table output sending cvlan 100 traffic from SWITCH to LEAF, for which TOR nodes add svlan 1000 and egress same to LEAF and LEAF ixa also receives double tag.

```
TOR1#show mlag domain details
```

```
-----
Domain Configuration
-----
```

## MLAG with Provider Bridging Configuration

---

Domain System Number : 1  
Domain Address : 2222.3333.4444  
Domain Priority : 32768  
Intra Domain Interface : ce2/1

Hello RCV State : Current  
Hello Periodic Timer State : Slow Periodic  
Domain Sync : IN\_SYNC  
Neigh Domain Sync : IN\_SYNC  
Domain Adjacency : UP  
Domain Sync via : Intra-domain-interface

-----  
MLAG Configuration  
-----

### MLAG-1

Mapped Aggregator : po1  
Admin Key : 16385  
Oper Key : 16385  
Physical status : 1  
Physical properties Digest : 1b bc c2 24 5a 1c cf 6 88 32 a1 4b 62 c2 c0 2

Neigh Admin Key : 32769  
Neigh Physical status : 1  
Neigh Physical Digest : 1b bc c2 24 5a 1c cf 6 88 32 a1 4b 62 c2 c0 2  
Info RCV State : Current  
Info Periodic Time State : Standby  
Mlag Sync : IN\_SYNC  
Mode : Active-Active  
Current Mlag state : Active

### MLAG-3

Mapped Aggregator : po3  
Admin Key : 16387  
Oper Key : 16387  
Physical status : 1  
Physical properties Digest : 46 51 95 9d e2 90 81 47 d0 51 d9 de 4f 8 48 93

Neigh Admin Key : 32771  
Neigh Physical status : 1  
Neigh Physical Digest : 46 51 95 9d e2 90 81 47 d0 51 d9 de 4f 8 48 93  
Info RCV State : Current  
Info Periodic Time State : Standby  
Mlag Sync : IN\_SYNC  
Mode : Active-Active  
Current Mlag state : Active

TOR1#

---

TOR1#show mlag domain summary

-----  
Domain Configuration  
-----

Domain System Number : 1  
Domain Address : 2222.3333.4444  
Domain Priority : 32768  
Intra Domain Interface : ce2/1  
Domain Adjacency : UP  
Domain Sync via : Intra-domain-interface  
-----

MLAG Configuration  
-----

MLAG-1

Mapped Aggregator : po1  
Physical properties Digest : 1b bc c2 24 5a 1c cf 6 88 32 a1 4b 62 c2 c0 2  
Total Bandwidth : 400g  
Mlag Sync : IN\_SYNC  
Mode : Active-Active  
Current Mlag state : Active

MLAG-3

Mapped Aggregator : po3  
Physical properties Digest : 46 51 95 9d e2 90 81 47 d0 51 d9 de 4f 8 48 93  
Total Bandwidth : 400g  
Mlag Sync : IN\_SYNC  
Mode : Active-Active  
Current Mlag state : Active

TOR1#

TOR1#show etherchannel summary

Aggregator po1 100001  
Aggregator Type: Layer2  
Admin Key: 16385 - Oper Key 16385  
Link: ce23/1 (5001) sync: 1 (Mlag-active-link)  
Link: ce27/1 (5029) sync: 1 (Mlag-active-link)  
-----

Aggregator po3 100003  
Aggregator Type: Layer2  
Admin Key: 16387 - Oper Key 16387  
Link: ce25/1 (5005) sync: 1 (Mlag-active-link)  
Link: ce24/1 (5117) sync: 1 (Mlag-active-link)

TOR1#

## MLAG with Provider Bridging Configuration

---

TOR2#show mlag domain details

-----  
Domain Configuration  
-----

Domain System Number : 2  
Domain Address : 2222.3333.4444  
Domain Priority : 32768  
Intra Domain Interface : ce37

Hello RCV State : Current  
Hello Periodic Timer State : Slow Periodic  
Domain Sync : IN\_SYNC  
Neigh Domain Sync : IN\_SYNC  
Domain Adjacency : UP  
Domain Sync via : Intra-domain-interface

-----  
MLAG Configuration  
-----

MLAG-1

Mapped Aggregator : po1  
Admin Key : 32769  
Oper Key : 16385  
Physical status : 1  
Physical properties Digest : 1b bc c2 24 5a 1c cf 6 88 32 a1 4b 62 c2 c0 2

Neigh Admin Key : 16385  
Neigh Physical status : 1  
Neigh Physical Digest : 1b bc c2 24 5a 1c cf 6 88 32 a1 4b 62 c2 c0 2  
Info RCV State : Current  
Info Periodic Time State : Standby  
Mlag Sync : IN\_SYNC  
Mode : Active-Active  
Current Mlag state : Active

MLAG-3

Mapped Aggregator : po3  
Admin Key : 32771  
Oper Key : 16387  
Physical status : 1  
Physical properties Digest : 46 51 95 9d e2 90 81 47 d0 51 d9 de 4f 8 48 93

Neigh Admin Key : 16387  
Neigh Physical status : 1  
Neigh Physical Digest : 46 51 95 9d e2 90 81 47 d0 51 d9 de 4f 8 48 93  
Info RCV State : Current  
Info Periodic Time State : Standby

```

Mlag Sync           : IN_SYNC
Mode                : Active-Active
Current Mlag state  : Active

```

TOR2# show mlag domain summary

```

-----
Domain Configuration
-----

```

```

Domain System Number      : 2
Domain Address            : 2222.3333.4444
Domain Priority           : 32768
Intra Domain Interface    : ce37
Domain Adjacency         : UP
Domain Sync via          : Intra-domain-interface

```

```

-----
MLAG Configuration
-----

```

MLAG-1

```

Mapped Aggregator       : po1
Physical properties Digest : 1b bc c2 24 5a 1c cf 6 88 32 a1 4b 62 c2 c0 2
Total Bandwidth         : 400g
Mlag Sync               : IN_SYNC
Mode                    : Active-Active
Current Mlag state      : Active

```

MLAG-3

```

Mapped Aggregator       : po3
Physical properties Digest : 46 51 95 9d e2 90 81 47 d0 51 d9 de 4f 8 48 93
Total Bandwidth         : 400g
Mlag Sync               : IN_SYNC
Mode                    : Active-Active
Current Mlag state      : Active

```

TOR2#

TOR2#show etherchannel summary

```

Aggregator po1 100001
Aggregator Type: Layer2
Admin Key: 32769 - Oper Key 16385
  Link: ce31 (5062) sync: 1 (Mlag-active-link)
  Link: ce32 (5064) sync: 1 (Mlag-active-link)

```

```

-----
Aggregator po3 100003
Aggregator Type: Layer2
Admin Key: 32771 - Oper Key 16387
  Link: ce7 (5029) sync: 1 (Mlag-active-link)
  Link: ce8 (5031) sync: 1 (Mlag-active-link)

```

## MLAG with Provider Bridging Configuration

---

TOR2#

SWITCH2#show bridge

bridge 1 is running on rstp vlan-bridge

Ageout time is global and if something is configured for vxlan then it will be affected here also

Bridge	CVLAN	SVLAN	BVLAN	Port	MAC Address	FWD	Time-out
1	100			xe8	0000.2223.2425	1	300

SWITCH2#

SWITCH2#

SWITCH2#show mac address-table bridge 1

CVLAN	SVLAN	MAC Address	Type	Ports	Port-security
100		0000.2223.2425	dynamic	xe8	Disable

SWITCH2#

TOR1# show bridge

bridge 1 is running on provider-rstp edge

Ageout time is global and if something is configured for vxlan then it will be affected here also

Bridge	CVLAN	SVLAN	BVLAN	Port	MAC Address	FWD	Time-out
1		1000		m1ag1	0000.2223.2425	1	300

TOR1#show mac address-table bridge 1

CVLAN	SVLAN	MAC Address	Type	Ports	Port-security
	1000	0000.2223.2425	dynamic	m1ag1	Disable

TOR1#

TOR2#show bridge

bridge 1 is running on provider-rstp edge

Ageout time is global and if something is configured for vxlan then it will be affected here also

Bridge	CVLAN	SVLAN	BVLAN	Port	MAC Address	FWD	Time-out
1		1000		m1ag1	0000.2223.2425	1	300

TOR2#

TOR2#

TOR2#show mac address-table bridge 1

CVLAN	SVLAN	MAC Address	Type	Ports	Port-security
	1000	0000.2223.2425	dynamic	m1ag1	Disable

TOR2#

```
LEAF#show mac address-table bridge 1
CVLAN  SVLAN  MAC Address      Type      Ports      Port-security
-----+-----+-----+-----+-----+-----
          1000  0000.2223.2425  dynamic   po3        Disable
LEAF#
```

```
LEAF#show bridge
bridge 1 is running on provider-rstp edge
Ageout time is global and if something is configured for vxlan then it will be affected here also
Bridge      CVLAN  SVLAN  BVLAN  Port      MAC Address      FWD  Time-out
-----+-----+-----+-----+-----+-----+-----+-----+
1           1000          po3     0000.2223.2425  1      300
LEAF#
```

Now send traffic with svlan-1000 and c-vlan 100 from LEAF to SWITCH, Tor removes svlan and send only cvlan to SWITCH

```
LEAF#show bridge
bridge 1 is running on provider-rstp edge
Ageout time is global and if something is configured for vxlan then it will be affected here also
Bridge      CVLAN  SVLAN  BVLAN  Port      MAC Address      FWD  Time-out
-----+-----+-----+-----+-----+-----+-----+-----+
1           1000          po3     0000.2223.2425  1      300
1           1000          xe24    0000.2425.2627  1      300
LEAF#
```

```
LEAF#show mac address-table bridge 1
CVLAN  SVLAN  MAC Address      Type      Ports      Port-security
-----+-----+-----+-----+-----+-----
          1000  0000.2223.2425  dynamic   po3        Disable
          1000  0000.2425.2627  dynamic   xe24        Disable
LEAF#
```

```
TOR1#show bridge
bridge 1 is running on provider-rstp edge
Ageout time is global and if something is configured for vxlan then it will be affected here also
Bridge      CVLAN  SVLAN  BVLAN  Port      MAC Address      FWD  Time-out
-----+-----+-----+-----+-----+-----+-----+-----+
1           1000          mlag1   0000.2223.2425  1      300
1           1000          mlag3   0000.2425.2627  1      300
```

## MLAG with Provider Bridging Configuration

---

TOR1#

TOR1#show mac address-table bridge 1

CVLAN	SVLAN	MAC Address	Type	Ports	Port-security
	1000	0000.2223.2425	dynamic	mlag1	Disable
	1000	0000.2425.2627	dynamic	mlag3	Disable

TOR1#

TOR2#show bridge

bridge 1 is running on provider-rstp edge

Ageout time is global and if something is configured for vxlan then it will be affected here also

Bridge	CVLAN	SVLAN	BVLAN	Port	MAC Address	FWD	Time-out
1		1000		mlag1	0000.2223.2425	1	300
1		1000		mlag3	0000.2425.2627	1	300

TOR2#

TOR2#show mac address-table bridge 1

CVLAN	SVLAN	MAC Address	Type	Ports	Port-security
	1000	0000.2223.2425	dynamic	mlag1	Disable
	1000	0000.2425.2627	dynamic	mlag3	Disable

TOR2#

SWITCH2#show bridge

bridge 1 is running on rstp vlan-bridge

Ageout time is global and if something is configured for vxlan then it will be affected here also

Bridge	CVLAN	SVLAN	BVLAN	Port	MAC Address	FWD	Time-out
1	100			xe8	0000.2223.2425	1	300
1	100			po1	0000.2425.2627	1	300

SWITCH2#

SWITCH2#show mac address-table bridge 1

CVLAN	SVLAN	MAC Address	Type	Ports	Port-security
100		0000.2223.2425	dynamic	xe8	Disable
100		0000.2425.2627	dynamic	po1	Disable

SWITCH2#





## L2CP with MLAG-Provider Bridging Configuring

### Switch

SWITCH#configure terminal	Enter configuration mode
SWITCH(config)#interface xe8	Enter interface configuration mode for xe8
SWITCH(config-if)#switchport	Configure switchport
SWITCH(config-if)#bridge-group 1 spanning-tree disable	Associate interface with bridge-group 1 by disabling spanning tree
SWITCH(config-if)#switchport mode trunk	Configure switchport mode as trunk
SWITCH(config-if)#switchport trunk allowed vlan all	Associate created vlans to xe8 interface
SWITCH(config-if)#l2protocol stp/lldp/elmi/efm/dot1x tunnel	Configure STP/LLDP/ELMI/EFM/dot1x protocol as Tunnel
SWITCH(config-if)#exit	Exit from interface mode
SWITCH(config)#commit	Commit the candidate configuration to the running configuration.

### TOR1 (PEB)

TOR1#configure terminal	Enter configuration mode
TOR1(config)#interface mlag1	Enter interface configuration mode for mlag1
TOR1(config-if)#switchport	Configure switchport
TOR1(config-if)#bridge-group 1 spanning-tree disable	Associate interface with bridge-group 1 and disable spanning-tree
TOR1(config-if)#switchport mode customer-edge trunk	Configure switchport mode customer edge
TOR1(config-if)# switchport customer-edge trunk allowed vlan add 100	Associate customer vlan100 to interface
TOR1(config-if)#switchport customer-edge vlan registration cvlan100	Attach registration table cvlan100 to interface
TOR1(config-if)#mode active-active	Configure mlag mode as active-active
TOR1(config-if)#l2protocol stp/lldp/elmi/efm/dot1x tunnel/peer/discard	Configure STP/LLDP/ELMI/EFM/dot1x protocol as tunnel/peer/discard
TOR1(config-if)#exit	Exit interface mode
TOR1(config)#commit	Commit the candidate configuration to the running configuration.

**TOR2 (PEB)**

TOR2#configure terminal	Enter configuration mode
TOR2(config)#interface mlag1	Enter interface configuration mode for mlag1
TOR2(config-if)#switchport	Configure switchport
TOR2(config-if)#bridge-group 1 spanning-tree disable	Associate interface with bridge-group 1 and disable spanning-tree
TOR2(config-if)#switchport mode customer-edge trunk	Configure switchport mode customer edge
TOR2(config-if)# switchport customer-edge trunk allowed vlan add 100	Associate customer vlan 100 to interface
TOR2(config-if)#switchport customer-edge vlan registration cvlan100	Attach registration table cvlan100 to interface
TOR2(config-if)#mode active-active	Configure mlag mode as active-active
TOR2(config-if)#l2protocol stp/lldp/elmi/efm/dot2x tunnel/peer/discard	Configure STP/LLDP/ELMI/EFM/dot1x protocol as tunnel/peer/discard
TOR2(config-if)#exit	Exit interface mode
TOR2(config)#commit	Commit the candidate configuration to the running configuration.

**Validation****Switch:**

```
SWITCH#show l2protocol processing interface xe8
```

Bridge	Interface Name	Protocol	Processing Status	Hardware Status
1	xe8	stp	Tunnel	Tunnel
1	xe8	lacp	None	Peer
1	xe8	dot1x	Tunnel	Tunnel
1	xe8	lldp	Tunnel	Tunnel
1	xe8	efm	Tunnel	Tunnel
1	xe8	elmi	Tunnel	Tunnel

**TOR1:**

```
TOR1#show l2protocol processing interface mlag1
```

Bridge	Interface Name	Protocol	Processing Status	Hardware Status
1	mlag1	stp	peer	peer
1	xe8	lacp	None	Peer
1	xe8	dot1x	Tunnel	Tunnel
1	xe8	lldp	Tunnel	Tunnel
1	xe8	efm	discard	discard
1	xe8	elmi	discard	discard

```
TOR1#show l2protocol interface mlag1 counters
Interface mlag1
Peer           : stp                : 241782
```

### TOR2:

```
TOR2#show l2protocol processing interface mlag1
Bridge  Interface Name  Protocol      Processing Status  Hardware Status
=====  =====
1       mlag1              stp           peer              peer
1       xe8                lacp          None              Peer
1       xe8                dot1x         Tunnel            Tunnel
1       xe8                lldp          Tunnel            Tunnel
1       xe8                efm           discard           discard
1       xe8                elmi          discard           discard
```

## CHAPTER 22 IGMP Snooping for Provider Bridge

---

The existing IGMP Snooping extended to support in the Provider Bridged (PB) network. The PB connects customer LANs using the switched provider network consisting of SVLAN bridges and provider edge bridges. Each customer LAN is connected to a separate service VLAN inside the provider network. Current release supports the IGMPv1/IGMPv2/IGMPv3.

The following are supported:

- Snooping entries are captured in provider bridge network
- Egress traffic from router is tagged with single SVLAN ID
- IGMP snooping feature supported only in SVLAN

For more information on [Support IGMP Snooping for Provider Bridge](#) refer to *OcNOS Key Feature* document, Release 6.4.1.



# Data Center Bridging Configuration Guide





## CHAPTER 1 Priority-based Flow Control Configuration

This chapter shows how to:

- Enable PFC on a bridge and interface
- Configure priorities and link delay allowance for PFC

### Topology



SW1

Figure 1-42: PFC Enabled Bridge

### Configuring a Bridge and Interface for PFC

#configure terminal	Enter configure mode
(config)#bridge 1 protocol ieee vlan-bridge	Create bridge 1 as an IEEE VLAN-enabled bridge
(config)#data-center-bridging enable bridge 1	Enables DCB on the bridge
(config)#priority-flow-control enable bridge 1	Enables PFC on the bridge
(config)#interface eth1	Configure interface eth1
(config-if)#switchport	Configure eth1 as a layer 2 port
(config-if)#bridge-group 1	Configure eth1 in bridge group 1
(config-if)#lldp-agent	Enter into LLDP agent mode.
(lldp-agent)#set lldp enable txrx	Configure LLDP for transmit and receive mode on eth1
(lldp-agent)#lldp tlv ieee-8021-org-specific data-center-bridging select	Configure LLDP to send an IEEE 802.1 organizationally specific TLV set in the packet
(lldp-agent)#exit	Exit from LLDP mode.
(config-if)#priority-flow-control mode on	Configure the advertise flag and start sending DCBX TLVs in LLDP messages

### Configuring Priorities and Link Delay Allowance for PFC

#configure terminal	Enter Configure Mode.
(config)#bridge 1 protocol ieee vlan-bridge	Create bridge 1 as an IEEE VLAN-enabled bridge

## Priority-based Flow Control Configuration

(config)#data-center-bridging enable bridge 1	Enables DCB on the bridge
(config)#priority-flow-control enable bridge 1	Enables PFC on the bridge
(config)#interface eth1	Configure interface eth1
(config-if)#switchport	Configure eth1 as a layer 2 port
(config-if)#bridge-group 1	Configure eth1 in bridge group 1
(config-if)#lldp-agent	Enter into LLDP agent mode.
(lldp-agent)#set lldp enable txrx	Configure LLDP for transmit and receive mode on eth1
(lldp-agent)#llldp tlv ieee-8021-org-specific data-center-bridging select	Configure LLDP to send an IEEE 802.1 organizationally specific TLV set in the packet
(lldp-agent)#exit	Exit from LLDP mode.
(config-if)#priority-flow-control mode on	Configure the advertise flag and start sending DCBX TLVs in LLDP messages
(config-if)#priority-flow-control cap 4	Configure the maximum number of PFC priorities
(config-if)#priority-flow-control enable priority 2 4 5	Enable PFC on priorities 2, 4, and 5
(config-if)#priority-flow-control link-delay-allowance 34567	Configure the link delay allowance

## Validation

### 1. Verify the default data set.

```
#sh priority-flow-control statistics bridge 1
bridge : 1
interface pri pause sent      pause received
=====
eth1      0 00                00
eth1      1 00                00
eth1      2 00                00
eth1      3 00                00
eth1      4 00                00
eth1      5 00                00
eth1      6 00                00
eth1      7 00                00
```

```
#sh priority-flow-control details bridge 1
```

```
Admin Configuration
```

```
interface mode advertise willing cap link delay priorities allowance
=====
```

```
eth1      on    on    off    4    34567    2 4 5
```

```
Operational Configuration
```

```
-----
```

```
interface state cap link delay priorities allowance
=====
```

```
eth1      on    4    34567    2 4 5
```

## CHAPTER 2 DCBx Configuration

This chapter show how to configure PFC parameter exchange.

### Topology



Figure 2-43: DCBx Configuration

## Configuring ETS Parameter Exchange

### SW1

#configure terminal	Enter configure mode
(config)#bridge 1 protocol ieee vlan-bridge	Create bridge 1 as an IEEE VLAN-enabled bridge
(config)#data-center-bridging enable bridge 1	Enables DCB on the bridge
(config)#priority-flow-control enable bridge 1	Enables PFC on the bridge
(config)#interface eth1	Configure interface eth1
(config-if)#switchport	Configure eth1 as a layer 2 port
(config-if)#bridge-group 1	Configure eth1 in bridge group 1
(config-if)#lldp-agent	Enter into LLDP agent mode.
(lldp-agent)#set lldp enable txrx	Configure LLDP for transmit and receive mode on eth1
(lldp-agent)#l1ldp tlv ieee-8021-org- specific data-center-bridging select	Configure LLDP to send an IEEE 802.1 organizationally specific TLV set in the packet
(lldp-agent)#exit	Exit from LLDP mode.
(config-if)#priority-flow-control mode on	Configure the advertise flag and start sending DCBX TLVs in LLDP messages
(config-if)# priority-flow-control cap 4	Configure the maximum number of PFC priorities
(config-if)# priority-flow-control enable priority 2 3 4	Enables PFC on priorities 2,3, and 4
(config-if)# priority-flow-control linkdelay- allowance 34567	Configure the link delay allowance

**SW2**

#configure terminal	Enter configure mode
(config)#bridge 1 protocol ieee vlan-bridge	Create bridge 1 as an IEEE VLAN-enabled bridge
(config)#data-center-bridging enable bridge 1	Enables DCB on the bridge
(config)#priority-flow-control enable bridge 1	Enables PFC on the bridge
(config)#interface eth1	Configure interface eth1
(config-if)#switchport	Configure eth1 as a layer 2 port
(config-if)#bridge-group 1	Configure eth1 in bridge group 1
(config-if)#lldp-agent	Enter into LLDP agent mode.
(lldp-agent)#set lldp enable txrx	Configure LLDP for transmit and receive mode on eth1
(lldp-agent)#lldp tlv ieee-8021-org- specific data-center-bridging select	Configure LLDP to send an IEEE 802.1 organizationally specific TLV set in the packet
(lldp-agent)#exit	Exit from LLDP mode.
(config-if)#priority-flow-control mode auto	Configure the advertise flag and start sending DCBX TLVs in LLDP messages
(config-if)# priority-flow-control cap 4	Configure the maximum number of PFC priorities
(config-if)# priority-flow-control enable priority 2 3 4	Enables PFC on priorities 2,3, and 4
(config-if)# priority-flow-control linkdelay- allowance 34567	Configure the link delay allowance

**Validation**

**SW1**

Verify the data set.

```
OcNOS#sh priority-flow-control details interface xe31
```

```
bridge : 1
priority flow control : on
interface : eth1
```

Admin Configuration

```
-----
mode  advertise willing  cap  link delay  priorities
      allowance
=====
auto  on          on    4    34567      2 3 4
-----
```

## Operational Configuration

```
-----
state cap   link delay  priorities
           allowance
=====
```

```
off   4       34567           2 3 4
```

**SW2**

Verify the data set.

```
OcNOS#sh priority-flow-control details interface xe31
```

```
bridge : 1
priority flow control : on
interface : eth1
```

## Admin Configuration

```
-----
mode  advertise willing  cap  link delay  priorities
           allowance
=====
```

```
on    on           off    4    34567           2 3 4
```

## Operational Configuration

```
-----
state cap   link delay  priorities
           allowance
=====
```

```
on    4       34567           2 3 4
```

## Configuring PFC Parameter Exchange

**SW2**

#configure terminal	Enter configure mode
(config)#bridge 1 protocol ieee vlan-bridge	Create bridge 1 as an IEEE VLAN-enabled bridge
(config)#data-center-bridging enable bridge 1	Enable DCB on the bridge
(config)#priority-flow-control enable bridge 1	Enable PFC on the bridge
(config)#interface eth1	Configure interface eth1
(config-if)#switchport	Configure eth1 as a layer 2 port
(config-if)#bridge-group 1	Configure eth1 in bridge group 1
(config-if)#lldp-agent	Enter into LLDP agent mode.
(lldp-agent)#set lldp enable txrx	Configure LLDP for transmit and receive mode on eth1

## DCBx Configuration

<code>(lldp-agent)#lldp tlv-select ieee-8021-org-specific</code>	Configure LLDP to send an IEEE 802.1 organizationally specific TLV set in the packet
<code>(lldp-agent)#exit</code>	Exit from LLDP mode.
<code>(config-if)#priority-flow-control mode on</code>	Configure the advertise flag and start sending DCBx TLVs in LLDP messages
<code>(config-if)#priority-flow-control cap 4</code>	Configure the maximum number of PFC priorities
<code>(config-if)#priority-flow-control enable priority 2 4 5</code>	Enables PFC on priorities 2,4, and 5
<code>(config-if)#priority-flow-control link-delay-allowance 34567</code>	Configure the link delay allowance

## SW1

<code>#configure terminal</code>	Enter configure mode
<code>(config)#bridge 1 protocol ieee vlan-bridge</code>	Create bridge 1 as an IEEE VLAN-enabled bridge
<code>(config)#data-center-bridging enable bridge 1</code>	Enable DCB on the bridge
<code>(config)#priority-flow-control enable bridge 1</code>	Enable PFC on the bridge
<code>(config)#interface eth1</code>	Configure interface eth1
<code>(config-if)#switchport</code>	Configure eth1 as a layer 2 port
<code>(config-if)#bridge-group 1</code>	Configure eth1 in bridge group 1
<code>(config-if)#lldp-agent</code>	Enter into LLDP agent mode.
<code>(lldp-agent)#set lldp enable txrx</code>	Configure LLDP for transmit and receive mode on eth1
<code>(lldp-agent)#lldp tlv-select ieee-8021-org-specific</code>	Configure LLDP to send an IEEE 802.1 organizationally specific TLV set in the packet
<code>(lldp-agent)#exit</code>	Exit from LLDP mode.
<code>(config-if)#priority-flow-control mode on</code>	Configure the advertise flag and start sending DCBx TLVs in LLDP messages
<code>(config-if)#priority-flow-control cap 4</code>	Configure the maximum number of PFC priorities
<code>(config-if)#priority-flow-control enable priority 2 4 5</code>	Enables PFC on priorities 2,4, and 5
<code>(config-if)#priority-flow-control link-delay-allowance 34567</code>	Configure the link delay allowance

## Validation

### SW1

Verify the data set.

```
#show priority-flow-control details interface eth1
bridge : 1
priority flow control : on
interface : eth1
```

```
Admin Configuration
mode advertise willing cap link priorities
delay
```

```

=====
                                allowance
=====
on    on        off        4    34567    2 4 5

Operational Configuration
state cap  link        priorities
          delay
          allowance
=====
on    4    34567    2 4 5

```

**SW2**

Verify the data set.

```

#show priority-flow-control details interface eth1
bridge : 1
priority flow control : on
interface : eth1

```

```

Admin Configuration
mode  advertise willing  cap  link        priorities
          delay
          allowance

```

```

=====
==
on    on        off        4    34567    2 4 5

Operational Configuration
state cap  link        priorities
          delay
          allowance
=====
==
on    4    34567    2 4 5

```





## CHAPTER 3 PFC with QoS Configuration

Priority-based Flow Control (PFC) is a way which provides a link-level flow control mechanism that can be controlled independently for each frame priority. The goal of this mechanism is to ensure zero loss(lossless) under congestion in DCB networks.

Quality of Service (QoS) works by default with lossy behaviour, which is required for proper functioning of minimum bandwidth, shaping and scheduling.

The requirement is to support PFC when QoS is enabled, ability to control lossy/lossless setting of port queues

### Topology

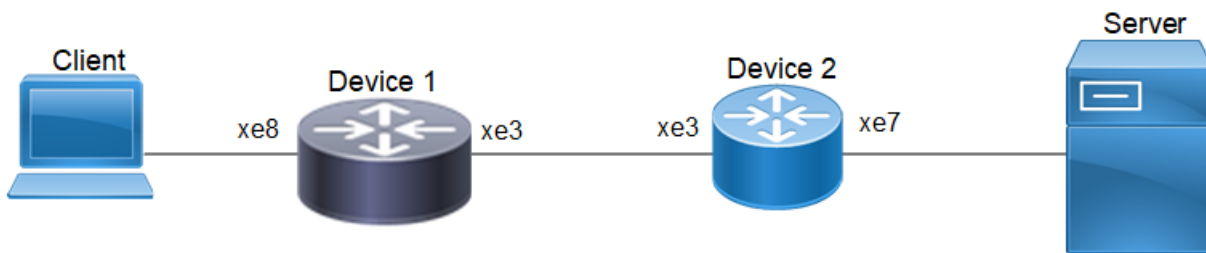

Figure 3-44: PFC with QoS

### PFC with QoS Configuration

PFC + QoS functionality : On setting lossless on queue, traffic should be not be dropped at egress queue and on setting PFC on ingress, pause frames will be generated in order to reduce excess ingress traffic.

### Configuration on Device-1

OcNOS#conf ter	Enter configure mode
OcNOS(config)#hostname Device-1	Configure host name
OcNOS(config)#commit	Commit
Device-1(config)#qos enable	Enable QoS
Device-1(config)#qos statistics	Enable QoS Statistics
Device-1(config)#bridge 1 protocol rstp vlan-bridge	Configure bridge group
Device-1(config)#data-center-bridging enable bridge 1	Enable data-center-bridging
Device-1(config)#priority-flow-control enable bridge 1	Enable priority-flow-control
Device-1(config)#commit	Commit
Device-1(config)#class-map type qos match- all CLASS1	Configure QoS Class-map

Device-1(config-cmap-qos)#match layer4 udp source-port 4791	Define a classification criteria
Device-1(config-cmap-qos)#exit	Exit
Device-1(config)#commit	Commit
Device-1(config)#policy-map type qos POLICY1	Configure QoS Policy-map
Device-1(config-pmap-qos)#class type qos CLASS1	Configure class type and specify the class-map type
Device-1(config-pmap-c-qos)#set queue 4	Setting a new value in the packet Egress queue for matched traffic
Device-1(config-pmap-c-qos)#exit	Exit
Device-1(config-pmap-qos)#commit	Commit
Device-1(config-pmap-qos)#policy-map type queuing default DEFAULTPOLICY	Configure QoS Policy-map
Device-1(config-pmap-que-def)# class type queuing default q0	Configure class type and specify the class-map type
Device-1(config-pmap-c-que-def)# priority	Priority value of class-map attached to this policy-map
Device-1(config-pmap-c-que-def)# exit	Exit
Device-1(config-pmap-que-def)# class type queuing default q4	Configure class type and specify the class-map type
Device-1(config-pmap-c-que-def)# priority	Priority value of class-map attached to this policy-map
Device-1(config-pmap-c-que-def)# lossless	enable lossless settings on egress queue
Device-1(config-pmap-c-que-def)# exit	Exit
Device-1(config-pmap-que-def)#commit	Commit
Device-1(config-pmap-que-def)#exit	Exit
Device-1(config)#interface xe3	Configure Interface
Device-1(config-if)# switchport	Set the switching characteristics of interface
Device-1(config-if)# bridge-group 1	Bridge-group
Device-1(config-if)# switchport mode trunk	Set the mode of L2 interface as trunk
Device-1(config-if)# switchport trunk allowed vlan all	Set the VLAN's to be allowed
Device-1(config-if)# shape rate 100 mbps burst 1000	Configure QoS egress traffic shape
Device-1(config-if)#exit	Exit
Device-1(config)#commit	Commit
Device-1(config)#interface xe8	Configure Interface
Device-1(config-if)# switchport	Set the switching characteristics of interface
Device-1(config-if)# bridge-group 1	Bridge-group
Device-1(config-if)# switchport mode trunk	Set the mode of L2 interface as trunk

Device-1(config-if)# switchport trunk allowed vlan all	Set the VLAN's to be allowed
Device-1(config-if)# priority-flow-control mode on	Set priority-flow-control mode as on
Device-1(config-if)# priority-flow-control enable priority 0 4	Set priority-flow-control mode's priority
Device-1(config-if)#service-policy type qos input POLICY1	Configure QoS service policy
Device-1(config-if)# shape rate 100 mbps burst 1000	Configure QoS egress traffic shape
Device-1(config-if)#exit	Exit
Device-1(config)#commit	Commit

## Configuration on Device-2

OcNOS#conf ter	Enter configure mode
OcNOS(config)#hostname Device-2	Configure host name
OcNOS(config)#commit	Commit
Device-2(config)#qos enable	Enable QOS
Device-2(config)#qos statistics	Enable QOS Statistics
Device-2(config)#bridge 1 protocol rstp vlan-bridge	Configure bridge group
Device-2(config)#data-center-bridging enable bridge 1	Enable data-center-bridging
Device-2(config)#priority-flow-control enable bridge 1	Enable priority-flow-control
Device-2(config)#commit	Commit
Device-2(config)#class-map type qos match-all CLASS1	Configure QOS Class-map
Device-2(config-cmap-qos)#match layer4 udp source-port 4791	Define a classification criteria
Device-2(config-cmap-qos)#exit	Exit
Device-2(config)#commit	Commit
Device-2(config)#policy-map type qos POLICY1	Configure QOS Policy-map
Device-2(config-pmap-qos)#class type qos CLASS1	Configure class type and specify the class-map type
Device-2(config-pmap-c-qos)#set queue 4	Setting a new value in the packet Egress queue for matched traffic

Device-2(config-pmap-c-qos)#exit	Exit
Device-2(config-pmap-qos)#commit	Commit
Device-2(config-pmap-qos)#policy-map type queuing default DEFAULTPOLICY	Configure QoS Policy-map
Device-2(config-pmap-que-def)# class type queuing default q0	Configure class type and specify the class-map type
Device-2(config-pmap-c-que-def)# priority	Priority value of class-map attached to this policy-map
Device-2(config-pmap-c-que-def)# exit	Exit
Device-2(config-pmap-que-def)# class type queuing default q4	Configure class type and specify the class-map type
Device-2(config-pmap-c-que-def)# priority	Priority value of class-map attached to this policy-map
Device-2(config-pmap-c-que-def)# lossless	enable lossless settings on egress queue
Device-2(config-pmap-c-que-def)# exit	Exit
Device-2(config-pmap-que-def)#commit	Commit
Device-2(config)#interface xe3	Configure Interface
Device-2(config-if)# switchport	Set the switching characteristics of interface
Device-2(config-if)# bridge-group 1	Bridge-group
Device-2(config-if)# switchport mode trunk	Set the mode of L2 interface as trunk
Device-2(config-if)# switchport trunk allowed vlan all	Set the VLAN's to be allowed
Device-2(config-if)# shape rate 100 mbps burst 1000	Configure QoS egress traffic shape
Device-2(config-if)#exit	Exit
Device-2(config)#commit	Commit
Device-2(config)#interface xe7	Configure Interface
Device-2(config-if)# switchport	Set the switching characteristics of interface
Device-2(config-if)# bridge-group 1	Bridge-group
Device-2(config-if)# switchport mode trunk	Set the mode of L2 interface as trunk
Device-2(config-if)# switchport trunk allowed vlan all	Set the VLAN's to be allowed
Device-2(config-if)# priority-flow-control mode on	Set priority-flow-control mode as on
Device-2(config-if)# priority-flow-control enable priority 0 4	Set priority-flow-control mode's priority
Device-2(config-if)#service-policy type qos input POLICY1	Configure QoS service policy
Device-2(config-if)# shape rate 100 mbps burst 1000	Configure QoS egress traffic shape
Device-2(config-if)#exit	Exit
Device-2(config)#commit	Commit

---

## Validation

Verify Pause frames Sent

```
Device-2#show priority-flow-control statistics bridge 1  
bridge : 1
```

```
interface pri pause sent      pause received  
=====
```

xe7	0	0	0
xe7	1	0	0
xe7	2	0	0
xe7	3	0	0
xe7	4	100265	0
xe7	5	0	0
xe7	6	0	0
xe7	7	0	0

Verify Pause frames Sent

```
Device-2#show priority-flow-control statistics bridge 1  
bridge : 1
```

```
interface pri pause sent      pause received  
=====
```

xe3	0	0	94731
xe3	1	0	0
xe3	2	0	0
xe3	3	0	0
xe3	4	0	0
xe3	5	0	0
xe3	6	0	0
xe3	7	0	0
xe8	0	181682	0
xe8	1	0	0
xe8	2	0	0
xe8	3	0	0
xe8	4	0	0
xe8	5	0	0
xe8	6	0	0
xe8	7	0	0



# Layer 2 Command Reference





## CHAPTER 1 Fundamental Layer 2 Commands

---

This chapter describes fundamental Layer 2 commands.

- [errdisable cause](#)
- [errdisable link-flap-setting](#)
- [errdisable timeout](#)
- [show errdisable details](#)
- [show interface errdisable status](#)
- [show running-config switch](#)
- [show tcp](#)
- [watch static-mac-movement](#)

---

## errdisable cause

Use this command to globally shut down a port when certain errors happen:

- BPDU guard puts an interface configured for Spanning Tree Protocol (STP) Port Fast into the ErrDisable state upon receipt of a STP BPDU to avoid a potential bridging loop.
- If one side of a link-access group (LAG) is configured as a static LAG and the other side as a dynamic LAG, the ports on the side receiving LACP BPDUs go into the ErrDisable state

Note: When link-flap ErrDisable is enabled globally, then all interfaces are enabled. Link-flap ErrDisable can be enabled globally, but disabled for a specific interface with the `no link-flap errdisable` command.

Note: Stp-Bpdu-Guard is enabled by default on the global level configuration.

Use `no` form of this command to not shut down a port when certain errors happen.

### Command Syntax

```
errdisable cause {stp-bpdu-guard|lag-mismatch|link-flap}
no errdisable cause {stp-bpdu-guard|lag-mismatch|link-flap}
```

### Parameters

<code>stp-bpdu-guard</code>	ErrDisable on stp-bpdu-guard
<code>lag-mismatch</code>	ErrDisable on lag-mismatch
<code>link-flap</code>	ErrDisable on link-flap

### Default

No default value is specified

### Command Mode

Configure mode

### Applicability

This command was introduced before OcnOS version 1.3.

### Examples

```
#configure terminal
(config)#errdisable cause lag-mismatch
```

## errdisable link-flap-setting

Use this command to configure the link-flap errdisable feature:

- An interface should change state as up-down to complete one cycle of a link flap.
- The LED does not glow when an interface is in the errdisable state.
- Errdisable is supported only on physical interfaces.
- A LAG interface does not go into the errdisable state when all of its member ports are in the errdisable state
- The error disable computation is based on a sliding window of time. The window size is configurable in seconds. This window is taken as the current time to the last <t> second, where <t> is the configured window size. If the accumulated link flap count reaches the maximum flap count for a particular sliding window, a link flap error disable fault is triggered.

Note: Any previous flapping accumulated is flushed when you execute this command.

### Command Syntax

```
errdisable link-flap-setting max-flaps <1-100> time <1-1800>
```

### Parameters

<1-100>	Maximum flap count
<1-1800>	Sliding window size in seconds

### Default

Five flaps in ten seconds:

Maximum flap count: 5

Sliding window size: 10 seconds

### Command Mode

Configure mode

### Applicability

This command was introduced before OcNOS version 1.3.

### Examples

```
#configure terminal
(config)#errdisable link-flap-setting max-flaps 5 time 20
```

---

## errdisable timeout

Use this command to set the ErrDisable auto-recovery timeout interval.

### Command Syntax

```
errdisable timeout interval <10-1000000>
```

### Parameters

<10-1000000>    Timeout interval in seconds

### Default

By default, zero: timer is disabled

### Command Mode

Configure mode

### Applicability

This command was introduced before OcNOS version 1.3.

### Examples

```
#configure terminal  
(config)#errdisable timeout interval 1000
```

---

## show errdisable details

Use this command to display ErrDisable settings.

### Command Syntax

```
show errdisable details
```

### Parameters

None

### Default

None

### Command Mode

Exec mode and Privileged Exec mode

### Applicability

This command was introduced before OcNOS version 1.3.

### Example

```
#show errdisable details
```

---

## show interface errdisable status

Use this command to display ErrDisable conditions for an interface.

### Command Syntax

```
show interface errdisable status
```

### Parameters

None

### Default

None

### Command Mode

Exec mode and Privileged Exec mode

### Applicability

This command was introduced before OcNOS version 1.3.

### Example

```
#show interface errdisable status
ge1 lag-mismatch-errdisable
ge2 stp-bpdu-guard-errdisable
```

---

## show running-config switch

Use this command to display the running system switch configuration.

### Command Syntax

```
show running-config switch bridge
show running-config switch dot1x
show running-config switch gmrp
show running-config switch gvrp
show running-config switch lacp
show running-config switch lmi
show running-config switch mstp
show running-config switch radius-server
show running-config switch rpvst+
show running-config switch rstp
show running-config switch ptp
show running-config switch stp
show running-config switch synce
show running-config switch vlan
```

### Parameters

bridge	Display Bridge group information.
dot1x	Display 802.1x port-based authentication information.
gmrp	Display GARP Multicast Registration Protocol (GMRP) information.
gvrp	Display GARP VLAN Registration Protocol (GVRP) information.
lacp	Display Link Aggregation Control Protocol (LACP) information.
lmi	Display Ethernet Local Management Interface Protocol (LMI) information.
mstp	Display Multiple Spanning Tree Protocol (MSTP) information.
radius-server	Display RADIUS server information.
rpvst+	Display Rapid Per-VLAN Spanning Tree (rpvst+) information.
rstp	Display Rapid Spanning Tree Protocol (RSTP) information.
ptp	Display Precision time Protocol (PTP)
stp	Display Spanning Tree Protocol (STP) information.
synce	Display synce information.
vlan	Display values associated with a single VLAN.

### Default

None

## Command Mode

Privileged exec mode, configure mode, router-map mode

## Applicability

This command was introduced before OcNOS version 1.3.

## Example

```
(config)#show running-config switch stp
!  
bridge 6 ageing-time 45  
bridge 6 priority 4096  
bridge 6 max-age 7
```



## show tcp

Use this command to display the Transmission Control Protocol (TCP) connections details.

### Command Syntax

```
show tcp
```

### Parameters

None

### Command Mode

Exec mode and privileged exec mode

### Applicability

This command was introduced before OcNOS version 1.3.

### Example

```
#show tcp
Proto Recv-Q Send-Q Local Address           Foreign Address         State
tcp      0      0 0.0.0.0:22             0.0.0.0:*              LISTEN
tcp      0      0 127.0.0.1:25           0.0.0.0:*              LISTEN
tcp      0      1 10.12.44.1:57740       127.0.0.1:705         CLOSE_WAIT
tcp     52      0 10.12.44.21:22         10.12.7.89:705        ESTABLISHED
tcp     85      0 10.12.44.21:57742     10.12.44.21:57738     ESTABLISHED
```

**Table 1-4: Show tcp output**

Entry	Description
Proto	Protocol – TCP
Recv-Q	Number of TCP packets in the Receive Queue.
Send-Q	Number of TCP packets in the Send-Q.
Local Address and port number	Local IP address and the port number.

**Table 1-4: Show tcp output (Continued)**

Entry	Description
Foreign Address and port number	Foreign (received) IP address and the port number.
State	Current state of TCP connections: ESTABLISHED SYN_SENT SYN_RECV FIN_WAIT1 FIN_WAIT2 TIME_WAIT CLOSE CLOSE_WAIT LAST_ACK LISTEN CLOSING UNKNOWN

---

## watch static-mac-movement

Use this command to watch if any MAC movement is detected over static MAC entries for a time period. Notification will be displaying if static MAC movement happens before the timer expires.

The counters can be validated with `show interface cpu counters queue-stats` for the L2 movement queue (Tx pkts and Dropped pkts columns).

Without enabling `watch static-mac-movement`, the statistics are reflected in the Rx EGR Port Unavail of [show interface counters queue-drop-stats](#).

For VXLAN, `watch static-mac-movement` applies to all the MAC entries learned from the remote peer (remote dynamic or static remote), as these learned MACs are installed as static MAC entries in the hardware.

### Command Syntax

```
watch static-mac-movement (<1-300>|)
```

### Parameters

<1-300>                   Timer value in seconds.

### Default

By default, the timer is 10 seconds

### Command Mode

Exec mode

### Applicability

This command was introduced before OcNOS version 1.3.

### Examples

```
#watch static-mac-movement
```



---

## CHAPTER 2 Bridge Commands

---

This chapter provides a description, syntax, and examples of the bridge commands. It includes the following commands:

- `bridge acquire`
- `bridge address`
- `bridge ageing`
- `bridge forward-time`
- `bridge hello-time`
- `bridge mac-priority-override`
- `bridge max-age`
- `bridge max-hops`
- `bridge priority`
- `bridge shutdown`
- `bridge transmit-holdcount`
- `bridge-group`
- `bridge-group path-cost`
- `bridge-group priority`
- `clear allowed-ethertype`
- `clear mac address-table`
- `dot1ad ethertype`
- `mac ageing display`
- `show allowed-ethertype`
- `show bridge`
- `show interface switchport`
- `show mac address-table count bridge`
- `show mac address-table bridge`
- `show mac-address-table bridge 1 learning`
- `switchport`
- `switchport allowed ethertype`

---

## bridge acquire

Use this command to enable a bridge to learn station location information for an instance. This helps in making forwarding decisions.

Use the `no` parameter with this command to disable learning.

### Command Syntax

```
bridge <1-32> acquire
no bridge <1-32> acquire
```

### Parameter

<1-32>                   Specify the bridge group ID.

### Default

By default, learning is enabled for all instances.

### Command Mode

Configure mode

### Applicability

This command was introduced before OcnOS version 1.3.

### Example

```
#configure terminal
(config)#bridge 3 acquire
(config)#no bridge 3 acquire
```

---

## bridge address

Use this command to add a static forwarding table entry for the bridge.

Use the no parameter with this command to remove the entry for the bridge

### Command Syntax

```
bridge <1-32> address XXXX.XXXX.XXXX (forward|discard) IFNAME
bridge <1-32> address XXXX.XXXX.XXXX (forward|discard) IFNAME vlan <2-4094>
bridge <1-32> address XXXX.XXXX.XXXX (forward|discard) IFNAME vlan <2-4094>
no bridge <1-32> address XXXX.XXXX.XXXX
no bridge <1-32> address XXXX.XXXX.XXXX vlan <2-4094>
no bridge <1-32> address XXXX.XXXX.XXXX vlan <2-4094>
```

### Parameters

<1-32>	Bridge identifier
XXXX.XXXX.XXXX	Media Access Control (MAC) address in HHHH.HHHH.HHHH format.
forward	Forward matching frames.
discard	Discard matching frames.
IFNAME	Interface on which the frame comes out.
vlan	Identity of the VLAN in the range of <2-4094>.

### Default

By default, bridge address is disabled

### Command Mode

Configure mode

### Applicability

This command was introduced before OcNOS version 1.3.

### Example

```
#configure terminal
(config)#bridge 1 address 0000.000a.0021 forward eth0
(config)#no bridge 1 address 0000.000a.0021
(config)#bridge 1 address 0011.2222.3333 forward xe5 vlan 23
(config)#no bridge 1 address 0011.2222.3333 vlan 23
(config)#bridge 1 address 0011.2222.3333 forward xe5 vlan 11
(config)#no bridge 1 address 0011.2222.3333 vlan 11 s
(config)#bridge 1 address 0011.2222.3334 discard xe6 vlan 12
(config)#no bridge 1 address 0011.2222.3334 vlan 12
```

---

## bridge ageing

Use this command to specify the aging time for a learned MAC address. A learned MAC address persists until this specified time.

Note: On XGS devices, it takes up to two ageing cycles to remove the mac entry from hardware, hence the timeout will be anywhere between mac-ageing-time to two times the mac-ageing-time. For example, if the MAC ageing time is set to 100 seconds, MAC ageing can happen anywhere between 100 to 199 seconds.

Note: The bridge aging time affects the ARP entries which are dependent upon the MAC addresses in hardware. If a MAC address ages out, it causes the corresponding ARP entry to refresh.

Use the `no` form of this command to set the MAC address aging time to its default (300).

### Command Syntax

```
bridge <1-32> ageing-time (<1-240>)
bridge <1-32> ageing disable
no bridge <1-32> ageing-time
```

### Parameters

0	Disable Ageing Time
<1-32>	Bridge group ID.
<1-240>	Aging time in minutes.
disable	Turn off MAC address aging completely.

### Default

By default, the aging time is 300 seconds.

### Command Mode

Configure mode

### Applicability

This command was introduced before OcNOS version 1.3.

### Example

```
#configure terminal
(config)#bridge 3 ageing-time 100
(config)#no bridge 3 ageing-time
```



---

## bridge forward-time

Use this command to set the time (in seconds) after which (if this bridge is the root bridge) each port changes states to learning and forwarding. This value is used by all instances.

Use the `no` parameter with this command to restore the default value of 15 seconds.

### Command Syntax

```
bridge <1-32> forward-time <4-30>
no bridge <1-32> forward-time
```

### Parameters

<1-32>	Specify the bridge group ID.
<4-30>	Specify the forwarding time delay in seconds.

Note: Care should be exercised if the value is to be made below 7 seconds.

### Default

By default, value is 15 seconds

### Command Mode

Configure mode

### Applicability

This command was introduced before OcnOS version 1.3.

### Example

```
#configure terminal
(config)#bridge 3 forward-time 6
(config)#no bridge 3 forward-time
```

---

## bridge hello-time

Use this command to set the hello-time, the time in seconds after which (if this bridge is the root bridge) all the bridges in a bridged LAN exchange Bridge Protocol Data Units (BPDUs). A very low value of this parameter leads to excessive traffic on the network, while a higher value delays the detection of topology change. This value is used by all instances.

Configure the bridge instance name before using this command. The allowable range of values is 1-10 seconds. However, make sure that the value of hello time is always greater than the value of hold time (2 seconds by default).

Use the `no` parameter to restore the default value of the hello time.

Note: A Bridge shall enforce the following relationships for Hello-time, Max-age and Forward-delay.

- $2 \times (\text{Bridge\_Forward\_Delay} - 1.0 \text{ seconds}) \geq \text{Bridge\_Max\_Age}$
- $\text{Bridge\_Max\_Age} \geq 2 \times (\text{Bridge\_Hello\_Time} + 1.0 \text{ seconds})$

Note: Hello-time is allowed only on RSTP, IEEE and Provider-RSTP types of bridges. For MSTP and Provider-MSTP hello timer is restricted.

### Command Syntax

```
bridge <1-32> hello-time <1-10>
no bridge <1-32> hello-time
```

### Parameters

- |        |   |
|--------|---|
| <1-32> | Specify the bridge group ID.                |
| <1-10> | Specify the hello BPDU interval in seconds. |

### Default

By default, value is 2 seconds

### Command Mode

Configure mode

### Applicability

This command was introduced before OcNOS version 1.3.

### Examples

```
#configure terminal
(config)#bridge 3 hello-time 3

(config)#no bridge 3 hello-time
```

---

## bridge mac-priority-override

Use this command to set a MAC priority override.

Use the `no` parameter with this command to unset a MAC priority override.

### Command Syntax

```
bridge <1-32> mac-priority-override mac-address MAC interface IFNAME vlan VLANID
  (static|static-priority-override|static-mgmt|static-mgmt-priority-override)
  priority <0-7>
no bridge <1-32> mac-priority-override mac-address MAC interface IFNAME vlan VLANID
```

### Parameters

<code>&lt;1-32&gt;</code>	Specify the bridge group ID.
<code>mac-address</code>	Enter a MAC address in HHHH.HHHH.HHHH format.
<code>interface</code>	Interface information
<code>vlan</code>	Add the values associated with a single VLAN
<code>static</code>	The MAC is a static entry
<code>static-mgmt</code>	The MAC is a Static Management
<code>static-mgmt-priority-override</code>	The MAC is a Static Management with priority override
<code>static-priority-override</code>	The MAC is a static with priority override
<code>priority</code>	<code>priority &lt;0-7&gt;</code> priority value

### Default

No default address is specified

### Command Mode

Configuration Mode

### Applicability

This command was introduced before OcNOS version 1.3.

### Examples

```
#configure terminal
(config)#bridge 1 mac-priority-override mac-address 1111.1111.1111 interface
eth1 vlan 2 static priority 2

(config)#no bridge 1 mac-priority-override mac-address 1111.1111.1111
interface eth1 vlan 2
```

---

## bridge max-age

Use this command to set the maximum age for a bridge. This value is used by all instances.

Maximum age is the maximum time in seconds for which (if a bridge is the root bridge) a message is considered valid. This prevents the frames from looping indefinitely. The value of maximum age should be greater than twice the value of hello time plus 1, but less than twice the value of forward delay minus 1. The allowable range for max-age is 6-40 seconds. Configure this value sufficiently high, so that a frame generated by root can be propagated to the leaf nodes without exceeding the maximum age.

Use the `no` parameter with this command to restore the default value of the maximum age.

Note: A Bridge shall enforce the following relationships for Hello-time, Max-age and Forward-delay.

- $2 \times (\text{Bridge\_Forward\_Delay} - 1.0 \text{ seconds}) \geq \text{Bridge\_Max\_Age}$
- $\text{Bridge\_Max\_Age} \geq 2 \times (\text{Bridge\_Hello\_Time} + 1.0 \text{ seconds})$

### Command Syntax

```
bridge <1-32> max-age <6-40>
no bridge <1-32> max-age
```

### Parameters

- |        |   |
|--------|---|
| <1-32> | Specify the bridge group ID.  |
| <6-40> | Specify the maximum time, in seconds, to listen for the root bridge <6-40>. |

### Default

By default, bridge maximum age is 20 seconds

### Command Mode

Configure Mode

### Applicability

This command was introduced before OcnOS version 1.3.

### Examples

```
#configure terminal
(config)#bridge 2 max-age 12

(config)#no bridge 2 max-age
```

## bridge max-hops

Use this command to specify the maximum allowed hops for a BPDU in an MST region. This parameter is used by all the instances of the MST. Specifying the maximum hops for a BPDU prevents the messages from looping indefinitely in the network. When a bridge receives an MST BPDU that has exceeded the allowed maximum hops, it discards the BPDU.

Use the `no` parameter with this command to restore the default value.

### Command Syntax

```
bridge <1-32> max-hops <1-40>
no bridge <1-32> max-hops
```

### Parameters

<1-32>	Specify the bridge-group ID.
<1-40>	Specify the maximum hops for which the BPDU will be valid <1-40>.

### Default

By default, maximum hops in an MST region are 20

### Command Mode

Configure mode

### Applicability

This command was introduced before OcnOS version 1.3.

### Examples

```
#configure terminal
(config)#bridge 3 max-hops 25

#configure terminal
(config)#no bridge 3 max-hops
```

---

## bridge priority

Use this command to set the bridge priority for the common instance. Using a lower priority indicates a greater likelihood of the bridge becoming root. The priority values can be set only in increments of 4096.

Use the `no` form of the command to reset it to the default value.

### Command Syntax

```
bridge (<1-32> | ) priority <0-61440>
no bridge (<1-32> | )priority
```

### Parameters

<1-32>	Specify the bridge group ID.
<0-61440>	Specify the bridge priority in the range of <0-61440>.

### Default

By default, priority is 32768 (or hex 0x8000).

### Command Mode

Configure mode

### Applicability

This command was introduced before OcnOS version 1.3.

### Examples

```
#configure terminal
(config)#bridge 2 priority 4096

(config)#no bridge 2 priority
```

---

## bridge shutdown

Use this command to disable a bridge.

Use the `no` parameter to reset the bridge.

### Command Syntax

```
bridge shutdown <1-32>
bridge shutdown <1-32> ((bridge-blocked|bridge-forward) |)
no bridge shutdown <1-32>
```

### Parameters

<1-32>	Specify the bridge group ID.
bridge-forward	Put all ports of the bridge into forwarding state
bridge-blocked	Put all ports of the bridge into blocked state

### Default

No default value is specified

### Command Mode

Configure mode

### Applicability

This command was introduced before OcnOS version 1.3.

### Example

```
#configure terminal
(config)#bridge shutdown 4
(config)#no bridge shutdown 4
```

---

## bridge transmit-holdcount

Use this command to set the maximum number of transmissions of BPDUs by the transmit state machine.

Use the `no` parameter with this command to restore the default transmit hold-count value.

### Command Syntax

```
bridge <1-32> transmit-holdcount <1-10>
no bridge <1-32> transmit-holdcount
```

### Parameters

<1-32>	Specify the bridge group ID.
<1-10>	Transmit hold-count value.

### Default

By default, transmit hold-count is 6

### Command Mode

Configure mode

### Applicability

This command was introduced before OcNOS version 1.3.

### Examples

```
#configure terminal
(config)#bridge 1 transmit-holdcount 5

(config)#no bridge 1 transmit-holdcount
```



## bridge-group

Use this command to bind an interface with a bridge specified by the parameter.

Use the `no` parameter with this command to disable this command.

### Command Syntax

```
bridge-group (<1-32>)  
no bridge-group (<1-32>)
```

### Parameters

<1-32>                    Specify the bridge group ID.

### Default

By default, `bridge-group` is disabled

### Command Mode

Interface mode

### Applicability

This command was introduced before OcnOS version 1.3.

### Examples

```
#configure terminal  
(config)#interface eth1  
(config-if)#bridge-group 2  
  
(config)#interface eth1  
(config-if)#no bridge-group 2
```

---

## bridge-group path-cost

Use this command to set the cost of a path associated with a bridge group. The lower the path cost, the greater the likelihood of the bridge becoming root.

Use the `no` parameter with this command to restore the default priority value.

### Command Syntax

```
bridge-group <1-32> path-cost <1-200000000>
no bridge-group <1-32> path-cost
```

### Parameters

<code>&lt;1-32&gt;</code>	Specify the bridge group ID.
<code>path-cost</code>	Specify the path-cost of a port.
<code>&lt;1-200000000&gt;</code>	Specify the cost to be assigned to the group.

### Default

By default, bridge-group is disabled

### Command Mode

Interface mode

### Applicability

This command was introduced before OcnOS version 1.3.

### Example

```
#configure terminal
(config)#interface eth1
(config-if)#bridge-group 3 path-cost 123

(config-if)#no bridge-group 3 path-cost
```

---

## bridge-group priority

Use this command to set the port priority for a bridge. A lower priority indicates a greater likelihood of the bridge becoming root.

### Command Syntax

```
bridge-group <1-32> priority <0-240>
no bridge-group <1-32> priority
```

### Parameters

<1-32>	Specify the bridge group ID.
<0-240>	Specify the port priority range (a lower priority indicates greater likelihood of the interface becoming a root). The priority values can only be set in increments of 16.

### Default

By default, priority is 1

### Command Mode

Interface mode

### Applicability

This command was introduced before OcnOS version 1.3.

### Example

```
#configure terminal
(config)#interface eth1
(config-if)#bridge-group 4 priority 96

(config)#interface eth1
(config-if)#no bridge-group 4 priority
```

---

## clear allowed-ethertype

Use this command to clear statistics for each ethertype per interfaces.

```
clear allowed-ethertype statistics (IFNAME|)
```

### Parameters

IFNAME                    Interface name.

### Command Mode

Exec mode

### Applicability

This command was introduced before OcnOS version 1.3.

### Example

```
#clear allowed-ethertype statistics xe54/1

#show allowed-ethertype statistics xe54/1
Interface xe54/1
arp: 0 Packets, 0 Bytes
ipv4: 0 Packets, 0 Bytes
ipv6: 0 Packets, 0 Bytes
dropped: 0 Packets, 0 Bytes
```

---

## clear mac address-table

Use this command to clear the filtering database for the bridge. This command can be issued to do the following:

- clear the filtering database
- clear all filtering database entries configured through CLI
- clear all multicast filtering database entries
- clear all multicast filtering database entries for a given VLAN or interface
- clear all multicast database entries based on a mac address

### Command Syntax

```
clear mac address-table (dynamic|multicast) bridge <1-32>
clear mac address-table (dynamic|multicast) (address MACADDR | interface IFNAME |
vlan VID ) bridge <1-32>
clear mac address-table (dynamic|multicast) (address MACADDR | interface IFNAME |
vlan VID ) (instance INST) bridge <1-32>
```

### Parameters

dynamic	Clears all dynamic entries.
multicast	Clears all multicast filtering database entries.
address	Clear the specified MAC Address.
MACADDR	When filtering database, entries are cleared based on the MAC address.
bridge	Clears the bridge group ID. Value range is 1-32.
bridge	Clears the bridge group ID. Value range is 1-32.
cvlan	Clears all MAC address for the specified CVLAN. Value range is 1-4094.
svlan	Clears all mac address for the specified SVLAN. Value range is 1-4094.
interface	Clears all MAC address for the specified interface.
bridge	Clears the bridge group ID. Value range is 1-32.
instance	Clears MSTP instance ID. Value range is <1-63>.
vlan	Clears all MAC address for the specified VLAN. Value range is 1-4094.
bridge	Clears the bridge group ID. Value range is 1-32.

### Command Mode

Privileged Exec mode

### Applicability

This command was introduced before OcNOS version 1.3.

### Examples

This example shows how to clear multicast filtering database entries:

```
#clear mac address-table multicast bridge 1
```

This example shows how to clear multicast filtering database entries for a given VLAN.

```
#clear mac address-table multicast vlan 2 bridge 1
```

This example shows how to clear all filtering database entries learned through bridge operation for a given MAC address.

```
#clear mac address-table dynamic address 0202.0202.0202 bridge 1
```

---

## dot1ad ethertype

Use this command to configure the service-tpid value on parent port of a subinterface. By this the tpid used for service tag for a subinterface may be inherited from the one applied to parent interface.

Use `no` form of this command to revert the value to default.

Note: For any dot1ad subinterface to be functional, `dot1ad ethertype` should be set to desired value as 0x88a8/0x9100/0x9200.

### Command Syntax

```
dot1ad ethertype (0x8100 | 0x88a8 | 0x9100 | 0x9200)
no dot1ad ethertype
```

### Parameters

0x8100	IEEE 802.1Q VLAN-tagged frame
0x88a8	IEEE 802.1ad Provider Bridging Service VLAN tag identifier (S-Tag)
0x9100	Supported for interoperability with legacy devices
0x9200	Supported for interoperability with legacy devices

### Default

Default value is 0x8100

### Command Mode

Interface mode

### Applicability

This command was introduced in OcNOS version 3.0.

### Example

```
(config)#interface xe1
(config-if)#dot1ad ethertype 0x9100
(config-if)#exit
(config)#interface xe1
(config-if)#no dot1ad ethertype
(config-if)#exit
```

---

## mac ageing display

Use this command to enable the display of remaining age-time value for dynamically learnt mac address.

Note: When the mac ageing display is enabled the following points are applicable .

- a. The mac ageing display should be enabled in non-scaled case (i.e less than 25% of table size) .
- b. High cpu usage will occurs if mac-ageing-display is enabled in scaled case.
- c. When enabled ,the appropriate ageing time for each entry will only be displayed after the first iteration of the ageing thread is complete which starts after 10 seconds of the cli commit .
- d. For mac entries with no active traffic, the age of the entries will be displayed based on the timestamp when the entries were first learnt. if the entries learnt time is greater than the bridge-mac-age-time (default 300secs), the age of the mac entries will be displayed as zero.

Use the `no` form of this command to disable the display of MAC address aging timeout. When disabled the mac-address age will be the bridge-mac-age-time default 300secs.

### Command Syntax

```
mac-ageing-display
no mac-ageing-display
```

### Parameters

None

### Default

By default, mac ageing display is disabled.

### Command Mode

Configure mode

### Applicability

This command was introduced before OcNOS Version 5.0.

### Example

```
#configure terminal
(config)#mac-ageing-display
(config)#no mac-ageing-display
```



---

## show allowed-ethertype

Use this command to show allowed and denied traffic statistics.

Note: Dropped slow protocol packets provides the count of slow protocol packets among the total dropped count. Total drop count is fetched from hardware and slow protocol packet count is fetched from software. Hence there can be one or two packet difference.

### Command Syntax

```
show allowed-ethertype statistics (IFNAME|)
```

### Parameters

IFNAME                    Interface name.

### Command Mode

Exec mode

### Applicability

This command was introduced before OcNOS version 1.3.

### Examples

```
#show allowed-ethertype statistics
Interface po1
arp : 0 Packets, 0 Bytes
ipv4 : 511016709 Packets, 184897169366 Bytes
ipv6 : 0 Packets, 0 Bytes
dropped : 220 Packets, 28160 Bytes
dropped slow protocol pkts : lacp 220, efm 0, others 0
Interface xe47
arp : 0 Packets, 0 Bytes
ipv4 : 169763534 Packets, 61427990740 Bytes
ipv6 : 0 Packets, 0 Bytes
dropped : 0 Packets, 0 Bytes
Interface xe48
arp : 0 Packets, 0 Bytes
ipv4 : 0 Packets, 0 Bytes
ipv6 : 0 Packets, 0 Bytes
dropped : 0 Packets, 0 Bytes
```

## show bridge

Use this command to display the filtering database for the bridge. The filtering database is used by a switch to store the MAC addresses that have been learned and which ports that MAC address was learned on.

Note: The user is notified with an alert message when the MAC hardware table size is full. The notification is generated for the operator log, SNMP trap and NetConf. When the MAC table is free again due to ageing or flushing, the clear notification is generated. Table full trap is SNMP OID .1.3.6.1.4.1.36673.122.2.1.1 and table clear trap SNMP OID is .1.3.6.1.4.1.36673.122.2.1.2 .

### Command Syntax

```
show bridge (ieee|rpvst+|mstp|)
```

### Parameters

ieee	STP bridges.
rpvst+	RPVST+ bridges.
mstp	MSTP bridges.

### Command Mode

Exec mode and Privileged Exec mode

### Applicability

This command was introduced before OcnOS version 1.3.

### Example

```
#show bridge
```

Ageout time is global and if something is configured for vxlan then it will be affected here also

```
Bridge      CVLAN  SVLAN  BVLAN  Port      MAC Address      FWD  Time-out
-----+-----+-----+-----+-----+-----+-----+-----+
1           1      1      1      eth1      5254.0029.929c   1    0
1           2      1      1      eth1      5254.004c.dcc6   1    297
1           1      1      1      eth1      5254.004c.dcc6   1    291
```

[Table 2-5](#) explains the show command output fields.

**Table 2-5: show bridge output fields**

Field	Description
Bridge	Bridge identifier.
VLAN, SVLAN, BVLAN	CVLAN, SVLAN, and BVLAN identifiers.
Port	Interface name.
MAC Address	Learned MAC address.
FWD	Whether frames for the MAC addresses are forwarded.
Time-out	How long the learned MAC address persists.



---

## show interface switchport

Use this command to display the characteristics of the interface with the current VLAN.

### Command Syntax

```
show interface switchport bridge <1-32>
```

### Parameter

bridge                    Bridge name.

### Command Mode

Exec mode and Privileged Exec mode

### Applicability

This command was introduced before OcNOS version 1.3.

### Example

The following is an output of this command displaying the characteristics of this interface on bridge 2.

```
#show interface switchport bridge 2
Interface name       : eth5
Switchport mode     : access
Ingress filter      : disable
Acceptable frame types : all
Vid swap            : disable
Default vlan        : 2
Configured vlans    : 2
Interface name       : eth4
Switchport mode     : access
Ingress filter      : disable
Acceptable frame types : all
Vid swap            : disable
Default vlan        : 1
Configured vlans    : 1
```

[Table 2-6](#) explains the show command output fields.

**Table 2-6: show interface switchport output fields**

Field	Description
Interface name	Display the name of interface.
Switchport mode	Port that used to connect between switches and access port.
Ingress filter	Ingress filtering examines all inbound packets and then permits or denies entry to the network.
Acceptable frame types	Type of acceptable frame in the interface.
VID swap	Displays the status of the VID swap.

---

**Table 2-6: show interface switchport output fields (Continued)**

Field	Description
Default vlan	Default value for the VLAN.
Configured vlans	Displays the information on configured VLANs.

## show mac address-table count bridge

Use this command to display a count of MAC entries from the filtering database.

### Command Syntax

```
show mac address-table (local|remote|) count bridge <1-32> ((dynamic | multicast |
static) | address MAC | interface IFNAME | vlan <1-4094> )|)
```

### Parameter

local	MAC entries learned locally
remote	MAC entries learned from MLAG MAC sync
<1-32>	Bridge group
dynamic	Dynamic entries
multicast	Multicast entries
static	Static entries
MAC	MAC address in HHHH.HHHH.HHHH format
IFNAME	Name of the interface
<1-4094>	VLAN identifier

### Command Mode

Exec mode

### Applicability

This command was introduced before OcNOS version 1.3.

### Example

```
#show mac address-table count bridge 1
MAC Entries for all vlans:
Total MAC Addresses in Use: 3
```

[Table 2-7](#) explains the show command output fields.

**Table 2-7: show mac address-table count output fields**

Field	Description
Multicast MAC Address Count	Number of multicast addresses.
Total MAC Addresses	Total number of addresses.

---

## show mac address-table bridge

Use this command to display MAC entries from the filtering database.

### Command Syntax

```
show mac address-table (local|remote|) bridge <1-32> ({(dynamic | multicast |
static) | address MAC | interface IFNAME | vlan <1-4094> }|)
```

### Parameter

local	MAC entries learned locally
remote	MAC entries learned from MLAG MAC sync
<1-32>	Bridge group
dynamic	Dynamic entries
multicast	Multicast entries
static	Static entries
MAC	MAC address in HHHH.HHHH.HHHH format
IFNAME	Name of the interface
<1-4094>	VLAN identifier

### Command Mode

Exec mode

### Applicability

This command was introduced before OcnOS version 1.3.

### Example

```
#show mac address-table bridge 1 static interface ge14
VLAN      MAC Address      Type      Ports
-----+-----+-----+-----+
  1        3333.3333.3333   static    ge14

#show mac address-table bridge 1
VLAN      MAC Address      Type      Ports
-----+-----+-----+-----+
  1        3417.ebf6.0ace   dynamic   po1
  1        6400.6a8e.48ab   dynamic   po1
  1        a82b.b5b5.c37b   dynamic   po1
  200      0000.5e00.0101   dynamic   po1
  200      3417.ebf6.0ac5   dynamic   po1
  200      3417.ebf6.0ace   dynamic   po1
  200      6400.6a8e.48ab   dynamic   po1
  200      a82b.b5b5.c375   dynamic   po1
  200      a82b.b5b5.c37b   dynamic   po1
  800      0000.5e00.0102   dynamic   po1
  800      3417.ebf6.0ac5   dynamic   po1
  800      3417.ebf6.0ace   dynamic   po1
  800      6400.6a8e.48ab   dynamic   po1
  800      a82b.b5b5.c375   dynamic   po1
```

```
800 a82b.b5b5.c37b dynamic po1
```

Table 2-8 explains the show command output fields.

**Table 2-8: show mac address-table output fields**

Field	Description
VLAN	VLAN identifier.
MAC Address	Media Access Control address.
Type	Dynamic, multicast, or static.
Ports	Interface name.



---

## show mac-address-table bridge 1 learning

Use this command to display if we have disabled mac learning in any of the interfaces.

### Command Syntax

```
show mac-address-table bridge <1-32> learning
```

### Parameter

<1-32>	Bridge group
Learning	mac learning

### Command Mode

Exec mode

### Applicability

This command was introduced before OcNOS version 1.3.

### Example

```
#no mac-address-table learning bridge 1 ?

interface      Interface
vlan           range(s): 2-5 10 or 2-5 7-19
OcNOS(config)#no mac-address-table learning bridge 1 interface xe1/1
OcNOS#show mac-address-table bridge 1 learning
!
no mac-address-table learning bridge 1 interface xe1/1
!
```

---

## switchport

Use this command to set the mode of an interface to switched.

All interfaces are configured routed by default. To change the behavior of an interface from switched to routed, you must explicitly give the `no switchport` command.

Note: When you change the mode of an interface from switched to routed and vice-versa, all configurations for that interface are erased.

Use the `no` form of this command to set the mode to routed.

### Command Syntax

```
switchport
no switchport
```

### Parameters

None

### Default

All interfaces are configured routed by default. To change the behavior of an interface from switched to routed, you must explicitly give the `no switchport` command.

### Command Mode

Interface mode

### Applicability

This command was introduced before OcNOS version 1.3.

### Examples

```
#configure terminal
(config)#interface eth0
(config-if)#switchport

(config)#interface eth0
(config-if)#no switchport
```

---

## switchport allowed ethertype

Use this command to allow a set of ethertype on the access port and deny remaining traffic.

Use the no command to remove ethertype configuration.

### Command Syntax

```
switchport allowed ethertype {arp|ipv4|ipv6|mpls|WORD|log}
no switchport allowed ethertype ({arp|ipv4|ipv6|mpls|WORD|log}|)
```

### Parameters

arp	Ethertype 0x0806.
ipv4	Ethertype 0x0800.
ipv6	Ethertype 0x086dd.
mpls	Ethertype 0x8847.
WORD	Any Ethertype value (0x600 - 0xFFFF).
log	Log unwanted ethertype packets.

### Default

No default value is specified

### Command Mode

Interface mode

### Applicability

This command was introduced before OcNOS version 1.3.

### Examples

```
#configure terminal
(config)#interface xe1
(config-if)#switchport allowed ethertype arp ipv4 ipv6 log

(config-if)#no switchport allowed ethertype ipv4
```



---

## CHAPTER 3 Spanning Tree Protocol Commands

---

This chapter provides a description, syntax, and examples of the Spanning Tree Protocol (STP), Rapid Spanning Tree Protocol (RSTP), Multiple Spanning Tree Protocol (MSTP), and Provider RSTP commands.

- [bridge cisco-interoperability](#)
- [bridge instance](#)
- [bridge instance priority](#)
- [bridge instance vlan](#)
- [bridge multiple-spanning-tree](#)
- [bridge protocol ieee](#)
- [bridge protocol mstp](#)
- [bridge protocol rstp](#)
- [bridge provider-rstp](#)
- [bridge rapid-spanning-tree](#)
- [bridge region](#)
- [bridge revision](#)
- [bridge spanning-tree](#)
- [bridge spanning-tree errdisable-timeout](#)
- [bridge spanning-tree force-version](#)
- [bridge spanning-tree pathcost](#)
- [bridge spanning-tree portfast](#)
- [bridge te-msti](#)
- [bridge te-msti vlan](#)
- [bridge-group instance](#)
- [bridge-group instance path-cost](#)
- [bridge-group instance priority](#)
- [bridge-group path-cost](#)
- [bridge-group priority](#)
- [bridge-group spanning-tree](#)
- [clear spanning-tree detected protocols](#)
- [clear spanning-tree statistics](#)
- [customer-spanning-tree customer-edge path-cost](#)
- [customer-spanning-tree customer-edge priority](#)
- [customer-spanning-tree forward-time](#)
- [customer-spanning-tree hello-time](#)
- [customer-spanning-tree max-age](#)
- [customer-spanning-tree priority](#)
- [customer-spanning-tree provider-edge path-cost](#)
- [customer-spanning-tree provider-edge priority](#)

- `customer-spanning-tree transmit-holdcount`
- `debug mstp`
- `show debugging mstp`
- `show debugging mstp`
- `show debugging mstp`
- `show spanning-tree`
- `show spanning-tree mst`
- `show spanning-tree statistics`
- `snmp restart mstp`
- `spanning-tree autoedge`
- `spanning-tree edgeport`
- `spanning-tree edgeport`
- `spanning-tree guard`
- `spanning-tree instance restricted-role`
- `spanning-tree instance restricted-tcn`
- `spanning-tree link-type`
- `spanning-tree mst configuration`
- `spanning-tree restricted-domain-role`
- `spanning-tree restricted-role`
- `spanning-tree restricted-tcn`
- `spanning-tree te-msti configuration`
- `storm-control`
- `show storm-control`

---

## bridge cisco-interoperability

Use this command to enable/disable Cisco interoperability for MSTP (Multiple Spanning Tree Protocol).

If Cisco interoperability is required, all OcnOS devices in the switched LAN must be Cisco-interoperability enabled. When OcnOS inter operates with Cisco, the only criteria used to classify a region are the region name and revision level. VLAN-to-instance mapping is not used to classify regions when interoperating with Cisco.

### Command Syntax

```
bridge <1-32> cisco-interoperability (enable | disable)
```

### Parameters

<1-32>	Specify the bridge group ID
enable	Enable Cisco interoperability for MSTP bridge
disable	Disable Cisco interoperability for MSTP bridge

### Default

By default, cisco interoperability is disabled.

### Command Mode

Configure mode

### Applicability

This command was introduced before OcnOS version 1.3.

### Examples

To enable Cisco interoperability on a switch for a bridge:

```
#configure terminal
(config)#bridge 2 cisco-interoperability enable
```

To disable Cisco interoperability on a switch for a particular bridge:

```
#configure terminal
(config)#bridge 2 cisco-interoperability disable
```

---

## bridge instance

Use this command to add an MST instance to a bridge.

Use the `no` form of this command to delete an MST instance identifier from a bridge.

### Command Syntax

```
bridge (<1-32>) instance (<1-63>)  
no bridge (<1-32>) instance (<1-63>)
```

### Parameters

<1-32>	Bridge identifier.
<1-63>	MST instance identifier.

### Default

The bridge instance default is 1.

### Command Mode

MST configure mode

### Applicability

This command was introduced before OcnOS version 1.3.

### Examples

```
#configure terminal  
(config)#bridge 4 protocol mstp  
(config)#spanning-tree mst configuration  
(config-mst)#bridge 4 instance 3  
...  
(config-mst)#no bridge 4 instance 3
```



---

## bridge instance priority

Use this command to set the bridge instance priority.

Use the `no` form of this command to reset the priority to its default.

### Command Syntax

```
bridge (<1-32>) instance <1-63> priority <0-61440>
no bridge (<1-32>) instance <1-63> priority
```

### Parameters

<code>&lt;1-32&gt;</code>	Specify the bridge identifier.
<code>&lt;1-63&gt;</code>	Specify the instance identifier.
<code>priority</code>	Specify the bridge priority for the instance. The lower the priority of the bridge, the better the chances is of the bridge becoming a root bridge or a designated bridge for the LAN. The priority values can be set only in increments of 4096. The default value is 32768.
<code>&lt;0-61440&gt;</code>	Specify the bridge priority.

### Default

By default, bridge instance priority is 32768

### Command Mode

Configure mode

### Applicability

This command was introduced before OcnOS version 1.3.

### Examples

```
(config)#bridge 4 instance 3 priority 1
```

## bridge instance vlan

Use this command to simultaneously add multiple VLANs for the corresponding instance of a bridge. The VLANs must be created before being associated with an MST instance (MSTI). If the VLAN range is not specified, the MSTI will not be created.

Use the `no` form of this command to simultaneously remove multiple VLANs for the corresponding instance of a bridge.

### Command Syntax

```
bridge (<1-32>) instance (<1-63>) vlan VLANID
no bridge (<1-32>) instance (<1-63>) vlan VLANID
```

### Parameters

<1-32>	Bridge identifier.
<1-63>	MST instance identifier.
VLANID	VLAN identifier(s) <2-4094>. You can specify a single VLAN, a VLAN range, or a VLAN list.  For a VLAN range, specify two VLAN identifiers: the lowest and then the highest separated by a hyphen. For a VLAN list, specify the VLAN identifiers separated by commas. Do not enter spaces between the hyphens or commas.

### Default

The bridge instance VLAN ID Interfaces default-switch is VLAN100 100 ae0.0 ae1.0 ae2.0.

### Command Mode

MST configure mode

### Applicability

This command was introduced before OcnOS version 1.3.

### Examples

To associate multiple VLANs, in this case VLANs 10 and 20 to instance 1 of bridge 1:

```
#configure terminal
(config)#bridge 1 protocol mstp
(config)#spanning-tree mst configuration
(config-mst)#bridge 1 instance 1 vlan 10,20
```

To associate multiple VLANs, in this case, VLANs 10, 11, 12, 13, 14, and 15 to instance 1 of bridge 1:

```
#configure terminal
(config)#bridge 1 protocol mstp
(config)#spanning-tree mst configuration
(config-mst)#bridge 1 instance 1 vlan 10-15
```

To delete multiple VLANs, in this case, VLANs 10 and 11 from instance 1 of bridge 1:

```
#configure terminal
(config)#bridge 1 protocol mstp
(config)#spanning-tree mst configuration
(config-mst)#no bridge 1 instance 1 vlan 10,11
```

---

## bridge multiple-spanning-tree

Use this command to enable MSTP globally on a bridge.

Use the `no` form of this command to disable MSTP globally on a bridge.

### Command Syntax

```
bridge <1-32> multiple-spanning-tree enable
no bridge <1-32> multiple-spanning-tree enable (bridge-blocked|bridge-forward|)
```

### Parameters

<code>&lt;1-32&gt;</code>	Bridge-group ID.
<code>bridge-blocked</code>	Put ports of the bridge in the blocked state (default).
<code>bridge-forward</code>	Put ports of the bridge in the forwarding state.

### Default

By default, this feature is enabled.

For the `no` form of this command, `bridge-blocked` is the default.

### Command Mode

Configure mode

### Applicability

This command was introduced before OcnOS version 1.3.

### Examples

```
#configure terminal
(config)#bridge 2 multiple-spanning-tree enable

#configure terminal
(config)#no bridge 2 multiple-spanning-tree enable bridge-forward
```

---

## bridge protocol ieee

Use this command to add a IEEE 802.1d Spanning Tree Protocol bridge.

After creating a bridge instance, add interfaces to the bridge using the `bridge-group` command. Bring the bridge instance into operation with the `no shutdown` command in interface mode.

Use the `no` parameter with this command to remove the bridge.

### Command Syntax

```
bridge <1-32> protocol ieee (vlan-bridge|)
no bridge <1-32>
```

### Parameters

<code>&lt;1-32&gt;</code>	Specify the bridge group ID.
<code>vlan-bridge</code>	Specify this as a VLAN-aware bridge.

### Default

The bridge protocol default value is 2 seconds.

### Command Mode

Configure mode

### Applicability

This command was introduced before OcNOS version 1.3.

### Example

```
#configure terminal
(config)#bridge 3 protocol ieee

(config)#bridge 4 protocol ieee vlan-bridge
```

---

## bridge protocol mstp

Use this command to create a multiple spanning-tree protocol (MSTP) bridge of a specified parameter. This command creates an instance of the spanning tree and associates the VLANs specified with that instance.

The MSTP bridges can have different spanning-tree topologies for different VLANs inside a region of “similar” MSTP bridges. The multiple spanning tree protocol, like the rapid spanning tree protocol, provides rapid reconfiguration capability, while providing load balancing ability. A bridge created with this command forms its own separate region unless it is added explicitly to a region using the `region name` command.

Use the `no` parameter with this command to remove the bridge.

### Command Syntax

```
bridge <1-32> protocol mstp (ring|)
no bridge <1-32>
```

### Parameters

<1-32>                      Specify the bridge group ID.

### Default

The bridge protocol mstp default value is 50 seconds

### Command Mode

Configure mode

### Applicability

This command was introduced before OcnOS version 1.3.

### Examples

```
#configure terminal
(config)#bridge 2 protocol mstp

#configure terminal
(config)#bridge 2 protocol mstp ring
```

---

## bridge protocol rstp

Use this command to add an IEEE 802.1w Rapid Spanning Tree Protocol (RSTP) bridge.

After creating a bridge instance, add interfaces to the bridge using the `bridge-group` command. Bring the bridge instance into operation with the `no shutdown` command in Interface mode.

Use the `no` parameter with this command to remove the bridge.

### Command Syntax

```
bridge <1-32> protocol rstp
bridge <1-32> protocol rstp (vlan-bridge|) (ring|)
no bridge <1-32>
```

### Parameters

<code>&lt;1-32&gt;</code>	Specify the bridge group ID.
<code>ring</code>	(Optional) Add an RSTP bridge for a ring topology.
<code>vlan-bridge</code>	(Optional) Adds a VLAN-aware bridge.

### Default

By default, `bridge protocol rstp` is enabled

### Command Mode

Configure mode

### Applicability

This command was introduced before OcnOS version 1.3.

### Examples

```
#configure terminal
(config)#bridge 2 protocol rstp

#configure terminal
(config)#bridge 3 protocol rstp vlan-bridge
```

---

## bridge provider-rstp

Use this command to enable Provider Rapid Spanning Tree Protocol (Provider RSTP) globally on a bridge.

Use the `no` form of this command to disable Provider RSTP globally on a bridge.

### Command Syntax

```
bridge <1-32> provider-rstp enable
no bridge <1-32> provider-rstp enable (bridge-blocked|bridge-forward|)
```

### Parameters

<1-32>	Bridge group ID.
bridge-blocked	Put ports of the bridge in the blocked state (default).
bridge-forward	Put ports of the bridge in the forwarding state.

### Default

By default, this feature is enabled.

For the `no` form of this command, `bridge-blocked` is the default.

### Command Mode

Configure mode

### Applicability

This command was introduced in OcNOS version 1.3.

### Examples

```
#configure terminal
(config)#bridge 2 provider-rstp enable

#configure terminal
(config)#no bridge 1 provider-rstp enable bridge-block
```

---

## bridge rapid-spanning-tree

Use this command to enable Rapid Spanning Tree Protocol (RSTP) globally on a bridge.

Use the `no` form of the command to disable RSTP globally on a bridge.

### Command Syntax

```
bridge <1-32> rapid-spanning-tree enable
no bridge <1-32> rapid-spanning-tree enable (bridge-blocked|bridge-forward|)
```

### Parameters

`<1-32>` Bridge group ID.

`bridge-blocked` Put ports of the bridge in the blocked state (default).

`bridge-forward` Put ports of the bridge in the forwarding state.

### Default

By default, this feature is enabled.

For the `no` form of this command, `bridge-blocked` is the default.

### Command Mode

Configure mode

### Applicability

This command was introduced before OcnOS version 1.3.

### Examples

```
#configure terminal
(config)#bridge 2 rapid-spanning-tree enable

#configure terminal
(config)#no bridge 2 rapid-spanning-tree enable bridge-forward
```



---

## bridge region

Use this command to create an MST region and specify its name. MST bridges of a region form different spanning trees for different VLANs.

Use the `no` form of the command to disable the Rapid Spanning Tree protocol on a region.

### Command Syntax

```
bridge <1-32> region REGION_NAME
no bridge <1-32> region
```

### Parameters

<1-32>	Specify the bridge group ID.
REGION_NAME	Specify the name of the region.

### Default

By default, each MST bridge starts with the region name as its bridge address. This means each MST bridge is a region by itself, unless specifically added to one.

### Command Mode

MST configure mode

### Applicability

This command was introduced before OcnOS version 1.3.

### Examples

```
#configure terminal
(config)#spanning-tree mst configuration
(config-mst)#bridge 3 region myRegion

(config)#spanning-tree mst configuration
(config-mst)#no bridge 3 region
```

---

## bridge revision

Use this command to specify the number for configuration information.

### Command Syntax

```
bridge <1-32> revision <0-65535>
```

### Parameters

<1-32>	Specify the bridge group ID in the range of <1-32>.
<0-65535>	Specify a revision number in the range of <0-65535>.

### Default

By default, revision number is 0

### Command Mode

MST configure mode

### Applicability

This command was introduced before OcNOS version 1.3.

### Example

```
#configure terminal  
(config)#spanning-tree mst configuration  
(config-mst)#bridge 3 revision 25
```

---

## bridge spanning-tree

Use this command to enable Spanning Tree Protocol (STP) globally on a bridge.

Use the `no` form of this command to disable STP globally on the bridge.

### Command Syntax

```
bridge <1-32> spanning-tree enable
no bridge <1-32> spanning-tree enable (bridge-blocked|bridge-forward|)
```

### Parameters

<code>&lt;1-32&gt;</code>	Bridge group ID.
<code>bridge-blocked</code>	Put ports of the bridge in the blocked state (default).
<code>bridge-forward</code>	Put ports of the bridge in the forwarding state.

### Default

By default, this feature is enabled.

For the `no` form of this command, `bridge-blocked` is the default.

### Command Mode

Configure mode

### Applicability

This command was introduced before OcnOS version 1.3.

### Examples

```
#configure terminal
(config)#bridge 2 spanning-tree enable

#configure terminal
(config)#no bridge 2 spanning-tree enable bridge-forward
```

---

## bridge spanning-tree errdisable-timeout

Use this command to enable the error-disable-timeout facility, which sets a timeout for ports that are disabled due to the BPDU guard feature.

The BPDU guard feature shuts down the port on receiving a BPDU on a BPDU-guard enabled port. This command associates a timer with the feature such that the port gets enabled back without manual intervention after a set interval.

Use the `no` parameter to disable the error-disable-timeout facility.

### Command Syntax

```
bridge <1-32> spanning-tree errdisable-timeout enable
bridge <1-32> spanning-tree errdisable-timeout interval <10-1000000>
no bridge <1-32> spanning-tree errdisable-timeout enable
no bridge <1-32> spanning-tree errdisable-timeout interval
```

### Parameters

<code>&lt;1-32&gt;</code>	Specify the bridge group ID.
<code>enable</code>	Enable the timeout mechanism for the port to be enabled back
<code>interval</code>	Specify the interval after which port shall be enabled.
<code>&lt;10-1000000&gt;</code>	Specify the error-disable-timeout interval in seconds.

### Default

By default, the port is enabled after 300 seconds

### Command Mode

Configure mode

### Applicability

This command was introduced before OcnOS version 1.3.

### Examples

```
#configure terminal
(config)#bridge 1 spanning-tree errdisable-timeout enable

#configure terminal
(config)#bridge 4 spanning-tree errdisable-timeout interval 34
```

---

## bridge spanning-tree force-version

Use this command to set the version for the bridge. A version identifier of less than a value of 2 enforces the spanning tree protocol. Although the command supports an input range of 0-4, for RSTP, the valid range is 0-2. When the force-version is set for a bridge, all ports of the bridge have the same spanning tree version set.

Use the `show spanning tree` command to display administratively configured and currently running values of the BPDU filter parameter for the bridge and port (see [show spanning-tree](#)).

Use the `no` parameter with this command to disable the version for the bridge.

### Command Syntax

```
bridge <1-32> spanning-tree force-version <0-4>
no bridge <1-32> spanning-tree force-version
```

### Parameters

<1-32>	Specify the bridge group ID.
force-version	Specify a force version identifier:
0	STP
1	Not supported
2	RSTP
3	MSTP

### Default

By default, spanning tree force version is 0

### Command Mode

Configure mode

### Applicability

This command was introduced before OcNOS version 1.3.

### Examples

Set the value to enforce the spanning tree protocol:

```
#configure terminal
(config)#bridge 1 spanning-tree force-version 0

(config)#no bridge 1 spanning-tree force-version
```

---

## bridge spanning-tree pathcost

Use this command to set a spanning-tree path cost method.

If the short parameter is used, the switch uses a value for the default path cost a number in the range 1 through 65,535. If the long parameter is used, the switch uses a value for the default path cost a number in the range 1 through 200,000,000. Refer to the [show spanning-tree](#) to view the administratively configured and current running pathcost method running on a bridge.

Use the no option with this command to return the path cost method to the default setting.

### Command Syntax

```
bridge <1-32> spanning-tree pathcost method (short|long)
no bridge <1-32> spanning-tree pathcost method
```

### Parameters

<1-32>	Specify the bridge group ID.
method	Method used to calculate default port path cost.
long	Use 16-bit based values for default port path costs.
short	Use 32-bit based values for default port path costs.

### Default

By default, path cost method for STP is short and for MSTP/RSTP is long.

### Command Mode

Configure mode

### Applicability

This command was introduced before OcNOS version 1.3.

### Examples

```
#configure terminal
(config)#bridge 1 spanning-tree pathcost method short

(config)#no bridge 1 spanning-tree pathcost method
```

---

## bridge spanning-tree portfast

Use this command to set the portfast BPDU (Bridge Protocol Data Unit) guard or filter for the bridge.

Use the `show spanning tree` command to display administratively configured and currently running values of the BPDU filter parameter for the bridge and port (see [show spanning-tree](#)).

Use the `no` parameter with this command to disable the BPDU filter for the bridge.

### BPDU Filter

All ports that have their BPDU filter set to default take the same value of BPDU filter as that of the bridge. The Spanning Tree Protocol sends BPDUs from all ports. Enabling the BPDU Filter feature ensures that PortFast-enabled ports do not transmit or receive any BPDUs.

### BPDU Guard

When the BPDU guard feature is set for a bridge, all portfast-enabled ports of the bridge that have the BPDU guard set to default shut down the port on receiving a BPDU. In this case, the BPDU is not processed. You can either bring the port back up manually by using the `no shutdown` command, or configure the `errdisable-timeout` feature to enable the port after the specified time interval.

### Command Syntax

```
bridge <1-32> spanning-tree portfast bpdu-guard
bridge <1-32> spanning-tree portfast bpdu-filter
no bridge <1-32> spanning-tree portfast bpdu-guard
no bridge <1-32> spanning-tree portfast bpdu-filter
```

### Parameters

<1-32>	Specify the bridge group ID.
bpdu-filter	Specify to filter the BPDUs on portfast enabled ports.
bpdu-guard	Specify to guard the portfast ports against BPDU receive.

### Default

By default, portfast for STP is enabled

### Command Mode

Configure mode

### Applicability

This command was introduced before OcnOS version 1.3.

### Example

```
#configure terminal
(config)#bridge 3 spanning-tree portfast bpdu-filter

#configure terminal
(config)#bridge 1 spanning-tree portfast bpdu-guard
```

---

## bridge te-msti

Use this command to enable or disable a Multiple Spanning Tree Instance (MSTI).

The `te-msti` always refers to the MST instance indexed by the pre-defined macro constant `MSTP_TE_MSTID` internally. This is the only MST instance which supports the disabling of spanning trees.

Use the `no` form of this command to remove the configuration.

### Command Syntax

```
bridge (<1-32>) te-msti
no bridge (<1-32>) te-msti
```

### Parameters

<code>&lt;1-32&gt;</code>	Specify the bridge group ID.
<code>te-msti</code>	MSTI to be the traffic engineering MSTI instance.

### Default

By default, bridge `te-msti` is disabled

### Command Mode

TE-MSTI Configure mode

### Applicability

This command was introduced before OcNOS version 1.3.

### Examples

```
#configure terminal
(config)#spanning-tree te-msti configuration
(config-te-msti)#bridge 2 te-msti

(config-te-msti)#no bridge 2 te-msti
```



---

## bridge te-msti vlan

Use this command to enable or disable a Multiple Spanning Tree Instance (MSTI). When an MSTI is shutdown (disabled) each VLAN in the MSTI is set to the forwarding state on all bridge ports which the VLAN as a member of. When and MSTI is enabled (no shutdown), normal MSTP operation is started for the MSTI.

The `te-msti` always refers to the MST instance indexed by the pre-defined macro constant `MSTP_TE_MSTID` internally. This is the only MST instance which supports the disabling of spanning trees. All VLANs that do not want spanning tree topology computation need to be assigned to this `te-msti` instance.

This command is intended for supporting Traffic Engineering (TE) Ethernet tunnels. All VLANs allocated for traffic engineering should be assigned to one MSTI. That MSTI can in turn shutdown the spanning tree operation so that each VLAN path through the network can be manually provisioned.

Use the `no` form of this command to remove the configuration.

### Command Syntax

```
bridge (<1-32>) te-msti vlan <1-4094>
no bridge (<1-32>) te-msti vlan <1-4094>
```

### Parameters

<code>&lt;1-32&gt;</code>	Specify the bridge group ID.
<code>vlan</code>	Specify a VLAN.
<code>&lt;1-4094&gt;</code>	Specify a VLAN identifier to be associated.

Note: This designated instance is defined in 802.1Qay clause 8.9 to be 0xFFE.

### Default

By default, `te-msti vlan` is `vlan1`.

### Command Mode

TE-MSTI Configure mode

### Applicability

This command was introduced before OcnOS version 1.3.

### Examples

```
#configure terminal
(config)#spanning-tree te-msti configuration
(config-te-msti)#bridge 2 te-msti vlan 10
(config-te-msti)#no bridge 2 te-msti vlan 10
```

---

## bridge-group instance

Use this command to assign a Multiple Spanning Tree (MST) instance to a port.

Use the `no` form of this command to remove the interface from the MST instance.

### Command Syntax

```
bridge-group (<1-32>) instance (<1-63> | te-msti)
no bridge-group (<1-32>) instance (<1-63> | te-msti)
```

### Parameters

<1-32>	Bridge identifier.
<1-63>	Multiple spanning tree instance identifier.
spbm	spbm
spbv	spbv
te-msti	Traffic engineering MSTI instance.

### Default

By default, the bridge port remains in the listening and learning states for 15 seconds before transitional to the forwarding state.

### Command Mode

Interface mode

### Applicability

This command was introduced before OcNOS version 1.3.

### Examples

```
#configure terminal
(config)#interface eth0
(config-if)#bridge-group 1
(config-if)#bridge-group 1 instance te-msti
```

---

## bridge-group instance path-cost

Use this command to set a path cost for a multiple spanning tree instance.

Before you can give this command, you must explicitly add an MST instance to a port using the `bridge-group instance` command.

Use the `no` form of this command to set the path cost to its default which varies depending on bandwidth.

### Command Syntax

```
bridge-group (<1-32>) instance <1-63> path-cost <1-200000000>
no bridge-group ( <1-32>) instance <1-63> path-cost
```

### Parameters

<1-32>	Bridge identifier.
<1-63>	Set the MST instance identifier.
<1-200000000>	Path cost for a port (a lower path cost means greater likelihood of becoming root).

### Default

Assuming a 10 Mb/s link speed, the default value is 200,000.

### Command Mode

Interface mode

### Applicability

This command was introduced before OcnOS version 1.3.

### Example

```
#configure terminal
(config)#spanning-tree mst configuration
(config-mst)#bridge 4 instance 3 vlan 3
(config-mst)#exit
(config)#interface eth1
(config-if)#bridge-group 4 instance 3
(config-if)#bridge-group 4 instance 3 path-cost 1000
```

---

## bridge-group instance priority

Use this command to set the priority of a multiple spanning tree instance.

The Multiple Spanning Tree Protocol uses port priority as a tiebreaker to determine which port should forward frames for a particular instance on a LAN, or which port should be the root port for an instance. A lower value implies a better priority. In the case of the same priority, the interface index will serve as the tiebreaker, with the lower-numbered interface being preferred over others.

### Command Syntax

```
bridge-group (<1-32>) instance (<1-63>) priority <0-240>
no bridge-group (<1-32>) instance (<1-63>) priority
```

### Parameters

<1-32>	Bridge identifier.
<1-63>	Multiple spanning tree instance identifier.
<0-240>	Port priority. A lower value means greater likelihood of becoming root. Set the port priority in increments of 16.

### Default

By default, the port priority is 128

### Command Mode

Interface mode

### Applicability

This command was introduced before OcNOS version 1.3.

### Example

```
(config)#interface eth2
(config-if)#bridge-group 2
(config-if)#bridge-group 2 instance 4
(config-if)#bridge-group 2 instance 4 priority 64
```

---

## bridge-group path-cost

Use this command to set the cost of a path. Before you can use this command to set a path-cost in a VLAN configuration, you must explicitly add an MST instance to a port using the `bridge-group instance` command.

Use the `no` parameter with this command to restore the default cost value of the path which varies depending on the bandwidth.

### Command Syntax

```
bridge-group <1-32> path-cost <1-200000000>
no bridge-group <1-32> path-cost
```

### Parameters

<code>&lt;1-32&gt;</code>	Specify the bridge group ID.
<code>path-cost</code> <code>&lt;1-200000000&gt;</code>	Specify the cost of path for a port. Specify the cost of the path (a lower cost means a greater likelihood of the interface becoming root).

### Default

Assuming a 10 Mb/s link speed, the default value is 200,000.

### Command Mode

Interface mode

### Applicability

This command was introduced before OcnOS version 1.3.

### Examples

```
#configure terminal
(config)#spanning-tree mst configuration
(config-mst)#bridge 4 instance 3 vlan 3
(config-mst)#exit
(config)#interface eth1
(config-if)#bridge-group 4
(config-if)#bridge-group 4 path-cost 1000
```

---

## bridge-group priority

Use this command to set the port priority for a bridge group.

The Multiple Spanning Tree Protocol uses port priority as a tiebreaker to determine which port should forward frames for a particular instance on a LAN, or which port should be the root port for an instance. A lower value implies a better priority. In the case of the same priority, the interface index will serve as the tiebreaker, with the lower-numbered interface being preferred over others.

### Command Syntax

```
bridge-group (<1-32>) priority <0-240>
no bridge-group (<1-32>) priority
```

### Parameters

<1-32>	Specify the bridge group ID.
<0-240>	Specify the port priority (a lower priority indicates greater likelihood of the interface becoming a root). The priority values can only be set in increments of 16.

### Default

By default, port priority for each instance is 128

### Command Mode

Interface mode

### Applicability

This command was introduced before OcNOS version 1.3.

### Example

```
#configure terminal
(config)#interface eth0
(config-if)#bridge-group 4 priority 80
```

---

## bridge-group spanning-tree

Use this command to enable or disable spanning-tree on an interface.

### Command Syntax

```
bridge-group <1-32> spanning-tree (disable|enable)
```

### Parameters

<1-32>	Bridge group ID.
disable	Disable spanning tree on the interface.
enable	Enable spanning tree on the interface.

### Default

By default, spanning-tree is enabled

### Command Mode

Interface mode

### Applicability

This command was introduced before OcnOS version 1.3.

### Example

```
(config)#interface eth1  
(config-if)#bridge-group 1 spanning-tree enable
```

---

## clear spanning-tree detected protocols

Use this command to clear the detected protocols for a specific bridge or interface. This command begins the port migration as per IEEE 802.1w-2001, Section 17.26. After issuing this command, the migration timer is started on the port, only if the force version is RSTP or MSTP (greater versions of RSTP).

### Command Syntax

```
clear spanning-tree detected protocols bridge <1-32>
```

### Parameters

<1-32>                    Specify the bridge group ID.

### Command Mode

Exec mode and Privileged Exec mode

### Applicability

This command was introduced before OcNOS version 1.3.

### Example

```
#clear spanning-tree detected protocols bridge 2
```



---

## clear spanning-tree statistics

Use this command to clear all STP BPDU statistics.

### Command Syntax

```
clear spanning-tree statistics bridge <1-32>
clear spanning-tree statistics interface IFNAME (instance (<1-63>)| vlan <1-4094>)
  bridge <1-32>
clear spanning-tree statistics (interface IFNAME| (instance (<1-63>)| vlan <2-
  4094>)) bridge <1-32>
```

### Parameters

<1-32>	Specify the bridge identifier.
IFNAME	Specify the name of the interface on which protocols have to be cleared.
<1-63>	MST instance ID.
<1-4094>	VLAN identifier where spanning tree is located <2-4094>

### Command Mode

Exec mode and Privileged Exec mode

### Applicability

This command was introduced before OcNOS version 1.3.

### Example

```
#clear spanning-tree statistics bridge 32
```

---

## customer-spanning-tree customer-edge path-cost

Use this command to set the cost of a path associated with a customer edge port on a customer edge spanning tree.

Use the `no` form of this command to remove the cost of a path associated with a customer edge port on a customer edge spanning tree.

### Command Syntax

```
customer-spanning-tree customer-edge path-cost <1-200000000>
no customer-spanning-tree customer-edge path-cost
```

### Parameters

<code>path-cost</code>	Specify the path-cost of a port.
<code>&lt;1-200000000&gt;</code>	Specify the cost to be assigned to the group.

### Default

Assuming a 10 Mb/s link speed, the default value is 200,000

### Command Mode

Interface mode

### Applicability

This command was introduced before OcNOS version 1.3.

### Example

```
#configure terminal
(config)#interface eth1
(config-if)#customer-spanning-tree customer-edge path-cost 1000
```

---

## customer-spanning-tree customer-edge priority

Use this command to set the port priority for a customer-edge port in the customer spanning tree.

### Command Syntax

```
customer-spanning-tree customer-edge priority <0-240>
```

### Parameters

priority	Specify the port priority.
<0-240>	Specify the port priority range (a lower priority indicates greater likelihood of the interface becoming a root). The priority values can only be set in increments of 16.

### Default

By default, priority is 1

### Command Mode

Interface mode

### Applicability

This command was introduced before OcnOS version 1.3.

### Example

```
#configure terminal
(config)#interface eth1
(config-if)#customer-spanning-tree customer-edge priority 100
```

---

## customer-spanning-tree forward-time

Use this command to set the time (in seconds) after which (if this bridge is the root bridge) each port changes states to learning and forwarding. This value is used by all instances.

Use the `no` form of this command to restore the default value of 15 seconds.

### Command Syntax

```
customer-spanning-tree forward-time <4-30>
no customer-spanning-tree forward-time
```

### Parameters

<4-30> Specify the forwarding time delay in seconds.

Note: Care should be exercised if the value is set to less than 7 seconds.

### Default

By default, priority is 15 seconds

### Command Mode

Interface mode

### Applicability

This command was introduced before OcNOS version 1.3.

### Examples

```
#configure terminal
(config)#interface eth1
(config-if)#customer-spanning-tree forward-time 6

(config-if)#no customer-spanning-tree forward-time
```

---

## customer-spanning-tree hello-time

Use this command to set the hello-time, the time in seconds after which (if this bridge is the root bridge) all the bridges in a bridged LAN exchange Bridge Protocol Data Units (BPDUs). Avoid a very low value of this parameter as this can lead to excessive traffic on the network; a higher value delays the detection of topology change. This value is used by all instances.

Use the `no` option with this command to restore the default value of the hello-time.

### Command Syntax

```
customer-spanning-tree hello-time <1-10>
no customer-spanning-tree hello-time
```

### Parameters

<1-10>                      Specify the hello BPDU interval in seconds.

### Default

By default, level is 2 seconds

### Command Mode

Interface mode

### Applicability

This command was introduced before OcnOS version 1.3.

### Examples

```
#configure terminal
(config)#interface eth1
(config-if)#customer-spanning-tree hello-time 3

(config-if)#no customer-spanning-tree hello-time
```

---

## customer-spanning-tree max-age

Use this command to set the max-age for a bridge.

Max-age is the maximum time in seconds for which (if a bridge is the root bridge) a message is considered valid. This prevents the frames from looping indefinitely. The value of max-age should be greater than twice the value of hello-time plus one, but less than twice the value of forward delay minus one. The allowable range for max-age is 6-40 seconds. Configure this value sufficiently high, so that a frame generated by a root can be propagated to the leaf nodes without exceeding the max-age.

Use the `no` parameter with this command to restore the default value of max-age.

### Command Syntax

```
customer-spanning-tree max-age <6-40>
no customer-spanning-tree max-age
```

### Parameters

<6-40>                    Specify the maximum time in seconds to listen for the root bridge.

### Default

By default, bridge max-age is 20 seconds

### Command Mode

Interface mode

### Applicability

This command was introduced before OcnOS version 1.3.

### Examples

```
#configure terminal
(config)#interface eth1
(config-if)#customer-spanning-tree max-age 12

(config-if)#no customer-spanning-tree max-age
```

---

## customer-spanning-tree priority

Use this command to set the bridge priority for the spanning tree on a customer edge port. Using a lower priority indicates a greater likelihood of the bridge becoming root. This command must be used to set the priority of the customer spanning tree running on the customer edge port.

Use the `no` form of the command to reset it to the default value.

### Command Syntax

```
customer-spanning-tree priority <0-61440>
no customer-spanning-tree priority
```

### Parameters

<0-61440> Specify the bridge priority in the range <0-61440>. Priority values can be set only in increments of 4096.

### Default

By default, priority is 61440

### Command Mode

Interface mode

### Applicability

This command was introduced before OcnOS version 1.3.

### Examples

```
#configure terminal
(config)#interface eth1
(config-if)#customer-spanning-tree priority 4096

(config-if)#no customer-spanning-tree priority
```

---

## customer-spanning-tree provider-edge path-cost

Use this command to set the cost of a path associated with a provider edge port on a customer edge spanning tree.

Use the `no` form of this command to remove the cost of a path associated with a provider edge port on a customer edge spanning tree.

### Command Syntax

```
customer-spanning-tree provider-edge svlan <1-4094> path-cost <1-200000000>
no customer-spanning-tree provider-edge svlan <1-4094> path-cost
```

### Parameters

<1-4094> Specify the SVLAN identifier of provider edge port.  
<1-200000000> Specify the cost to be assigned to the group.

### Default

Assuming a 10 Mb/s link speed, the default value is 200,000

### Command Mode

Interface mode

### Applicability

This command was introduced before OcnOS version 1.3.

### Examples

```
#configure terminal
(config)#interface eth1
(config-if)#customer-spanning-tree provider-edge svlan 2 path-cost 1000

(config-if)#no customer-spanning-tree provider-edge svlan 2 path-cost
```



---

## customer-spanning-tree provider-edge priority

Use this command to set the port priority for a provider-edge port in the customer spanning tree.

### Command Syntax

```
customer-spanning-tree provider-edge svlan <1-4094> priority <0-240>
```

### Parameters

<1-4094>	Specify the SVLAN identifier of provider edge port.
<0-240>	Specify the port priority (a lower priority means greater likelihood of the interface becoming root). The priority values can only be set in increments of 16.

### Default

By default, priority is 1

### Command Mode

Interface mode

### Applicability

This command was introduced before OcnOS version 1.3.

### Example

```
#configure terminal
(config)#interface eth1
(config-if)#customer-spanning-tree provider-edge svlan 2 priority 0
```

---

## customer-spanning-tree transmit-holdcount

Use this command to set the transmit-holdcount for a bridge.

Use the `no` parameter with this command to restore the default value of `transmit-holdcount`.

### Command Syntax

```
customer-spanning-tree transmit-holdcount <1-10>
no customer-spanning-tree transmit-holdcount
```

### Parameters

`<1-10>` Specify the maximum number that can be transmitted per second.

### Default

By default, bridge transmit hold count is 6

### Command Mode

Interface mode

### Applicability

This command was introduced before OcNOS version 1.3.

### Examples

```
#configure terminal
(config)#interface eth1
(config-if)#customer-spanning-tree transmit-holdcount 3

(config-if)#no customer-spanning-tree transmit-holdcount
```

---

## debug mstp

Use this command to turn on, and turn off, debugging and echoing data to the console, at various levels.

Note: This command enables MSTP, RSTP, and STP debugging.

Use the `no` parameter with this command to turn off debugging.

### Command Syntax

```
debug mstp all
debug mstp cli
debug mstp packet rx
debug mstp packet tx
debug mstp protocol
debug mstp protocol detail
debug mstp timer
debug mstp timer detail
no debug mstp all
no debug mstp cli
no debug mstp packet rx
no debug mstp packet tx
no debug mstp protocol
no debug mstp protocol detail
no debug mstp timer
no debug mstp timer detail
```

### Parameters

<code>all</code>	Echoes all spanning-tree debugging levels to the console.
<code>cli</code>	Echoes spanning-tree commands to the console.
<code>packet</code>	Echoes spanning-tree packets to the console.
<code>rx</code>	Received packets.
<code>tx</code>	Transmitted packets.
<code>protocol</code>	Echoes protocol changes to the console.
<code>detail</code>	Detailed output.
<code>timer</code>	Echoes timer start to the console.
<code>detail</code>	Detailed output.

### Command Mode

Exec, Privileged Exec, and Configure modes

### Applicability

This command was introduced before OcNOS version 1.3.

### Examples

```
#configure terminal
(config)#debug mstp all
(config)#debug mstp cli
(config)#debug mstp packet rx
(config)#debug mstp protocol detail
(config)#debug mstp timer
```

---

## show debugging mstp

Use this command to display the status of debugging of the MSTP system.

### Command Syntax

```
show debugging mstp
```

### Parameters

None

### Command Mode

Exec mode and Privileged Exec mode

### Applicability

This command was introduced before OcNOS version 1.3.

### Examples

```
#show debugging mstp
MSTP debugging status:
MSTP debugging status:
MSTP timer debugging is on
MSTP protocol debugging is on
MSTP detailed protocol debugging is on
MSTP cli echo debugging is on
MSTP transmitting packet debugging is on
MSTP receiving packet debugging is on
#
```

---

## show spanning-tree

Use this command to show the state of the spanning tree for all STP or RSTP bridge-groups, including named interface and VLANs.

### Command Syntax

```
show spanning-tree
show spanning-tree interface IFNAME
show spanning-tree mst
show spanning-tree mst config
show spanning-tree mst interface IFNAME
show spanning-tree mst detail
show spanning-tree mst detail interface IFNAME
show spanning-tree mst instance (<1-63>) interface IFNAME
show spanning-tree mst instance (<1-63> | te-msti)
show spanning-tree statistics bridge <1-32>
show spanning-tree statistics interface IFNAME (instance (<1-63>) | vlan <2-4094>)
  bridge <1-32>
show spanning-tree statistics (interface IFNAME | (instance (<1-63>) | vlan <1-
  4094>)) bridge <1-32>
show spanning-tree vlan range-index
```

### Parameters

interface	Display interface information
mst	Display MST information
statistics	Display statistics of the BPDUs
vlan range-index	Display a VLAN range-index value
config	Display configuration information
detail	Display detailed information
instance	Display instance information
<1-63>	Specify the instance identifier
te-msti	Display Traffic Engineering MSTI instance
<1-32>	Specify the bridge identifier
IFNAME	Display the interface name
<2-4094>	Specify a VLAN identifier, associated with the instance

### Command Mode

Exec mode and Privileged Exec mode

## Applicability

This command was introduced before OcnOS version 1.3.

## Example

The following is a sample output of this command displaying spanning tree information.

```
#show spanning-tree
% 1: Bridge up - Spanning Tree Enabled
% 1: Root Path Cost 0 - Root Port 0 - Bridge Priority 32768
% 1: Forward Delay 15 - Hello Time 2 - Max Age 20
% 1: Root Id 80000002b328530a
% 1: Bridge Id 80000002b328530a
% 1: last topology change Wed Nov 19 22:39:18 2008
% 1: 11 topology change(s) - last topology change Wed Nov 19 22:39:18 2008
% 1: portfast bpdu-filter disabled
% 1: portfast bpdu-guard disabled
% 1: portfast errdisable timeout disabled
% 1: portfast errdisable timeout interval 300 sec
%eth2: Ifindex 5 - Port Id 8005 - Role Designated - State Forwarding
%eth2: Designated Path Cost 0
%eth2: Configured Path Cost 200000 - Add type Explicit ref count 1
%eth2: Designated Port Id 8005 - Priority 128 -
%eth2: Root 80000002b328530a
%eth2: Designated Bridge 80000002b328530a
%eth2: Message Age 0 - Max Age 20
%eth2: Hello Time 2 - Forward Delay 15
%eth2: Forward Timer 0 - Msg Age Timer 0 - Hello Timer 1 - topo change timer 0
%eth2: forward-transitions 4
%eth2: Version Rapid Spanning Tree Protocol - Received RSTP - Send RSTP
%eth2: No portfast configured - Current portfast off
%eth2: portfast bpdu-guard default - Current portfast bpdu-guard off
%eth2: portfast bpdu-filter default - Current portfast bpdu-filter off
%eth2: no root guard configured- Current root guard off
%eth2: Configured Link Type point-to-point - Current point-to-point
%eth1: Ifindex 4 - Port Id 8004 - Role Designated - State Forwarding
%eth1: Designated Path Cost 0
%eth1: Configured Path Cost 200000 - Add type Explicit ref count 1
%eth1: Designated Port Id 8004 - Priority 128 -
%eth1: Root 80000002b328530a
%eth1: Designated Bridge 80000002b328530a
%eth1: Message Age 0 - Max Age 20
%eth1: Hello Time 2 - Forward Delay 15
%eth1: Forward Timer 0 - Msg Age Timer 0 - Hello Timer 1 - topo change timer 0
%eth1: forward-transitions 4
%eth1: Version Rapid Spanning Tree Protocol - Received None - Send RSTP
%eth1: No portfast configured - Current portfast off
%eth1: portfast bpdu-guard default - Current portfast bpdu-guard off
%eth1: portfast bpdu-filter default - Current portfast bpdu-filter off
%eth1: no root guard configured- Current root guard off
%eth1: Configured Link Type point-to-point - Current point-to-point
%
%
```

The following is a sample output of this command displaying the state of the spanning tree for interface `eth1`.

```
#show spanning-tree interface eth1
% 1: Bridge up - Spanning Tree Enabled
% 1: Root Path Cost 0 - Root Port 0 - Bridge Priority 32768
% 1: Forward Delay 15 - Hello Time 2 - Max Age 20
% 1: Root Id 80000002b328530a
% 1: Bridge Id 80000002b328530a
% 1: last topology change Wed Nov 19 22:39:18 2008
% 1: 11 topology change(s) - last topology change Wed Nov 19 22:39:18 2008
% 1: portfast bpdu-filter disabled
% 1: portfast bpdu-guard disabled
% 1: portfast errdisable timeout disabled
% 1: portfast errdisable timeout interval 300 sec
% eth1: Ifindex 4 - Port Id 8004 - Role Designated - State Forwarding
% eth1: Designated Path Cost 0
% eth1: Configured Path Cost 200000 - Add type Explicit ref count 1
% eth1: Designated Port Id 8004 - Priority 128 -
% eth1: Root 80000002b328530a
% eth1: Designated Bridge 80000002b328530a
% eth1: Message Age 0 - Max Age 20
% eth1: Hello Time 2 - Forward Delay 15
% eth1: forward-transitions 4
% eth1: Version Rapid Spanning Tree Protocol - Received None - Send RSTP
% eth1: No portfast configured - Current portfast off
% eth1: portfast bpdu-guard default - Current portfast bpdu-guard off
% eth1: portfast bpdu-filter default - Current portfast bpdu-filter off
% eth1: no root guard configured- Current root guard off
```

[Table 3-9](#) Explains the show command output fields.

**Table 3-9: show spanning-tree interface output fields**

Field	Description
Bridge up	A network bridge is a computer networking device that creates a single aggregate network from multiple communication networks or network segments.
Root Path Cost	Root cost for the interface.
Root Port	Interface that is the current elected root port for this bridge.
Bridge Priority	Used for the common instance.
Forward Delay	Configured time an STP bridge port remains in the listening and learning states before transitioning to the forwarding state.
Hello Time	Configured number of seconds between transmissions of configuration BPDUs.
Max Age	Maximum age of received protocol BPDUs.
Port Id	Logical interface identifier configured to participate in the MSTP instance.
Role Designated	Designated role for the packets in the interface.
State Forwarding	State of the forwarding packets in the interface.



---

<b>Field</b>	<b>Description</b>
Designated Path Cost	Designated cost for the interface.
Configured Path Cost	Configured cost for the interface.
Designated Port Id	Port ID of the designated port for the LAN segment this interface is attached to.
Priority	Specify the port priority.
Message Age	Number of seconds elapsed since the most recent BPDU was received.
Forward Timer	The forward delay timer is the time interval that is spent in the listening and learning state.
Msg Age Timer	The message age contains the length of time that has passed since the root bridge initially originated the BPDU.
Received RSTP	Number of times the received the RSTP.
Send RSTP	Number of times transmitted the RSTP.

---

## show spanning-tree mst

Use this command to display the filtering database values. This command displays the number of instances created, and VLANs associated with it.

### Command Syntax

```
show spanning-tree mst
show spanning-tree mst config
show spanning-tree mst detail
show spanning-tree mst detail interface IFNAME
show spanning-tree mst instance (<1-63>) interface IFNAME
show spanning-tree mst instance (<1-63> | te-msti)
show spanning-tree mst interface IFNAME
```

### Parameters

config	Display configuration information.
detail	Display detailed information.
interface	Display interface information.
instance	Display instance information.
<1-63>	Specify the instance identifier.
te-msti	Traffic Engineering MSTI instance.

### Command Mode

Exec mode and Privileged Exec mode

### Applicability

This command was introduced before OcNOS version 1.3.

### Examples

```
#show spanning-tree mst
% 1: Bridge up - Spanning Tree Enabled
% 1: CIST Root Path Cost 0 - CIST Root Port 0 - CIST Bridge
Priority 32768
% 1: Forward Delay 15 - Hello Time 2 - Max Age 20 - Max-hops 20
% 1: CIST Root Id 80000002b328530a
% 1: CIST Reg Root Id 80000002b328530a
% 1: CIST Bridge Id 80000002b328530a
% 1: 2 topology change(s) - last topology change Wed Nov 19 22:43:21 2008
% 1: portfast bpdu-filter disabled
% 1: portfast bpdu-guard disabled
```

```

% 1: portfast errdisable timeout disabled
% 1: portfast errdisable timeout interval 300 sec%
% Instance VLAN
% 0:      1
% 2:      3-4

```

Table 3-10 Explains the show command output fields.

**Table 3-10: show spanning-tree mst output fields**

Field	Description
Bridge up	A network bridge is networking process that creates a single aggregate network from multiple communication networks or network segments.
CIST Root Path Cost	Calculated cost to reach the regional root bridge from the bridge where the command is entered.
CIST Root Port	Interface that is the current elected CIST root port for this bridge.
CIST Bridge	A CIST bridge is networking process that creates a single aggregate network from multiple communication networks.
Priority	Specify the port priority.
Forward Delay	Configured time an STP bridge port remains in the listening and learning states before transitioning to the forwarding state.
Hello Time	Configured number of seconds between transmissions of configuration BPDUs.
Max Age	Maximum age of received protocol BPDUs.
Max-hops	Configured maximum number of hops a BPDU can be forwarded in the MSTP region.

---

## show spanning-tree statistics

Use this command to display detailed BPDU statistics for a spanning tree instance.

### Command Syntax

```
show spanning-tree statistics bridge <1-32>
show spanning-tree statistics interface IFNAME (instance (<1-63>)| vlan <2-4094>)
  bridge <1-32>
show spanning-tree statistics (interface IFNAME | (instance (<1-63>) | vlan <1-
  4094>)) bridge <1-32>
```

### Parameters

<1-32>	Bridge identifier.
<1-63>	MST instance identifier.
IFNAME	Displays the interface name.
<2-4094>	Specify a VLAN identifier, associated with the instance.

### Command Mode

Exec mode and Privileged Exec mode

### Applicability

This command was introduced before OcNOS version 1.3.

### Example

In the following example, bridge-group 1 is configured for IEEE on the eth2 interface.

```
#show spanning-tree statistics interface eth2 bridge 1

% BPDU Related Parameters
% -----
% Port Spanning Tree           : Enable
% Spanning Tree Type          : Spanning Tree Protocol
% Current Port State           : Learning
% Port ID                      : 8004
% Port Number                  : 4
% Path Cost                    : 200000
% Message Age                  : 0
% Designated Root              : 00:02:b3:d5:91:ec
% Designated Cost              : 0
% Designated Bridge            : 00:02:b3:d5:91:ec
% Designated Port Id           : 8005
% Top Change Ack               : FALSE
% Configure Pending            : FALSE

% PORT Based Information & Statistics
% -----
% Configure Bpdu's xmitted     : 0
% Configure Bpdu's received    : 22
% TCN Bpdu's xmitted          : 0
```

```

% TCN Bpdu's received          : 8
% Forward Trans Count         : 0

% STATUS of Port Timers
% -----
% Hello Time Configured       : 2
% Hello timer                 : ACTIVE
% Hello Time Value           : 1
% Forward Delay Timer        : ACTIVE
% Forward Delay Timer Value   : 1
% Message Age Timer          : ACTIVE
% Message Age Timer Value    : 19
% Topology Change Timer      : INACTIVE
% Topology Change Timer Value : 0
% Hold Timer                 : INACTIVE
% Hold Timer Value           : 0

% Other Port-Specific Info
% -----
% Max Age Transitions         : 1
% Msg Age Expiry             : 0
% Similar BPDUS Rcvd        : 14
% Src Mac Count              : 0
% Total Src Mac Rcvd        : 15
% Next State                 : Blocked
% Topology Change Time       : 0

% Other Bridge information & Statistics
% -----
% STP Multicast Address      : 01:80:c2:00:00:00
% Bridge Priority             : 32768
% Bridge Mac Address         : 00:02:b3:d5:98:3f
% Bridge Hello Time         : 2
% Bridge Forward Delay       : 15
% Topology Change Initiator  : 0
% Last Topology Change Occurred : Wed Dec 31 16:00:00 1969
% Topology Change           : FALSE
% Topology Change Detected   : FALSE
% Topology Change Count     : 0
% Topology Change Last Recvd from : 00:00:00:00:00:00

```

Table 3-11 Explains the show command output fields.

**Table 3-11: show spanning-tree statistics output fields**

Field	Description
BPDU Related Parameters	Details of the BPDU related parameters.
PORT Based Information & Statistics	Information of the port and interface for which the statistics are being displayed.

<b>Field</b>	<b>Description</b>
STATUS of Port Timers	Status of the port timers.
Other Port-Specific Info	Specific information about the port.
Other Bridge information & Statistics	Information about bridge and statistics being displayed.

---

## snmp restart mstp

Use this command to restart SNMP in Multiple Spanning Tree Protocol (MSTP).

### Command Syntax

```
snmp restart mstp
```

### Parameters

None

### Default

No default value is specified

### Command Mode

Configure mode

### Applicability

This command was introduced before OcNOS version 1.3.

### Examples

```
#snmp restart mstp
```

---

## spanning-tree autoedge

Use this command to assist in automatic identification of the edge port.

Use the `no` parameter with this command to disable this feature.

### Command Syntax

```
spanning-tree autoedge
no spanning-tree autoedge
```

### Default

By default, spanning-tree autoedge is disabled

### Parameters

None

### Command Mode

Interface mode

### Applicability

This command was introduced before OcNOS version 1.3.

### Example

```
#configure terminal
(config)#interface eth0
(config-if)#spanning-tree autoedge
```



---

## spanning-tree edgeport

Use this command to set a port as an edge-port and to enable rapid transitions.

Use the `no` parameter with this command to set a port to its default state (not an edge-port) and to disable rapid transitions.

**Note:** This command is an alias to the `spanning-tree portfast` command. Both commands can be used interchangeably.

### Command Syntax

```
spanning-tree edgeport
no spanning-tree edgeport
```

### Default

By default, spanning-tree edgeport is disabled

### Parameters

None

### Command Mode

Interface mode

### Applicability

This command was introduced before OcNOS version 1.3.

### Example

```
#configure terminal
(config)#interface eth0
(config-if)#spanning-tree edgeport
```

---

## spanning-tree guard

Use this command to enable the root guard feature for the port. This feature disables reception of superior BPDUs.

The root guard feature makes sure that the port on which it is enabled is a designated port. If the root guard enabled port receives a superior BPDU, it goes to a Listening state (for STP) or discarding state (for RSTP and MSTP).

Use the `no` parameter with this command to disable the root guard feature for the port.

### Command Syntax

```
spanning-tree guard root
no spanning-tree guard root
```

### Parameters

<code>root</code>	Set to disable reception of superior BPDUs
-------------------	--

### Default

By default, spanning-tree guard root is enabled

### Command Mode

Interface mode

### Applicability

This command was introduced before OcnOS version 1.3.

### Example

```
#configure terminal
(config)#interface eth0
(config-if)#spanning-tree guard root
```

---

## spanning-tree instance restricted-role

Use this command to set the restricted role value for the instance to TRUE.

Use the `no` parameter with this command to set the restricted role value for the instance to FALSE.

### Command Syntax

```
spanning-tree instance <1-63> restricted-role
no spanning-tree instance <1-63> restricted-role
```

### Parameters

<1-63>                    Specify the instance ID range.

### Default

By default, restricted-role value is FALSE

### Command Mode

Interface mode

### Applicability

This command was introduced before OcnOS version 1.3.

### Example

```
#configure terminal
(config)#interface eth0
(config-if)#spanning-tree instance 2 restricted-role
```

---

## spanning-tree instance restricted-tcn

Use this command to set the restricted TCN value for the instance to TRUE.

### Command Syntax

```
spanning-tree instance <1-63> restricted-tcn
no spanning-tree instance <1-63> restricted
```

### Parameters

<1-63> Specify the instance ID range.

### Default

By default, restricted TCN value is FALSE

### Command Mode

Interface mode

### Applicability

This command was introduced before OcnOS version 1.3.

### Example

```
#configure terminal
(config)#interface eth0
(config-if)#spanning-tree instance 2 restricted-tcn
```

---

## spanning-tree link-type

Use this command to enable or disable point-to-point or shared link types.

RSTP has a backward-compatible STP mode, `spanning-tree link-type shared`. An alternative is the `spanning-tree force-version 0`.

Use the `no` parameter with this command to disable rapid transition.

### Command Syntax

```
spanning-tree link-type auto
spanning-tree link-type point-to-point
spanning-tree link-type shared
no spanning-tree link-type
```

### Parameters

<code>auto</code>	Sets to either point-to-point or shared based on duplex state.
<code>point-to-point</code>	Enables rapid transition.
<code>shared</code>	Disables rapid transition.

### Default

By default, `spanning-tree link-type` is enabled.

### Command Mode

Interface mode

### Applicability

This command was introduced before OcNOS version 1.3.

### Examples

```
#configure terminal
(config)#interface eth0
(config-if)#spanning-tree link-type point-to-point

(config-if)#no spanning-tree link-type
```

---

## spanning-tree mst configuration

Use this command to enter the Multiple Spanning Tree Configuration mode.

### Command Syntax

```
spanning-tree mst configuration
```

### Parameters

None

### Default

No default value is specified.

### Command Mode

Configure mode

### Applicability

This command was introduced before OcNOS version 1.3.

### Examples

```
#configure terminal  
(config)#spanning-tree mst configuration  
(config-mst)#
```

---

## spanning-tree bpdu-filter

Use this command to set the BPDU filter value for individual ports. When the `enable` or `disable` parameter is used with this command, this configuration takes precedence over bridge configuration. However, when the `default` parameter is used with this command, the bridge level BPDU filter configuration takes effect for the port.

Use the `show spanning tree` command to display administratively configured and currently running values of the BPDU filter parameter for the bridge and port (see [show spanning-tree](#)).

Use the `no` parameter with this command to revert the port BPDU filter value to default.

### Command Syntax

```
spanning-tree bpdu-filter (enable|disable|default)
no spanning-tree bpdu-filter
```

### Parameters

<code>default</code>	Sets the bpdu-filter to the default level.
<code>disable</code>	Disables the BPDU-filter.
<code>enable</code>	Enables the BPDU-filter.

### Default

By default, `spanning-tree bpdu-filter` is default option

### Command Mode

Interface mode

### Applicability

This command was introduced before OcnOS version 1.3.

### Example

```
#configure terminal
(config)#interface eth0
(config-if)#spanning-tree bpdu-filter enable

(config-if)#no spanning-tree bpdu-filter
```

---

## spanning-tree bpdu-guard

Use this command to enable or disable the BPDU Guard feature on a port.

This command supersedes the bridge level configuration for the BPDU Guard feature. When the `enable` or `disable` parameter is used with this command, this configuration takes precedence over bridge configuration. However, when the `default` parameter is used with this command, the bridge-level BPDU Guard configuration takes effect.

Use the `show spanning tree` command to display administratively configured and currently running values of the BPDU filter parameter for the bridge and port (see [show spanning-tree](#)).

Use the `no` parameter with this command to set the BPDU Guard feature on a port to default.

### Command Syntax

```
spanning-tree bpdu-guard (enable|disable|default)
no spanning-tree bpdu-guard
```

### Parameters

<code>default</code>	Sets the BPDU-guard to the default level.
<code>disable</code>	Disables the BPDU-guard.
<code>enable</code>	Enables the BPDU-guard.

### Default

By default, `spanning-tree bpdu-guard` is default

### Command Mode

Interface mode

### Applicability

This command was introduced before OcnOS version 1.3.

### Example

```
#configure terminal
(config)#interface eth0
(config-if)#spanning-tree bpdu-guard enable

(config-if)#no spanning-tree bpdu-guard
```



---

## spanning-tree restricted-domain-role

Use this command to set the restricted-domain-role value of the port to TRUE.

Use the `no` parameter with this command to set the restricted-domain-role value of the port to FALSE.

### Command Syntax

```
spanning-tree restricted-domain-role
no spanning-tree restricted-domain-role
```

### Parameters

None

### Default

By default, restricted-role value is FALSE

### Command Mode

Interface mode

### Applicability

This command was introduced before OcnOS version 1.3.

### Example

```
#configure terminal
(config)#interface eth0
(config-if)#spanning-tree restricted-domain-role
```

---

## spanning-tree restricted-role

Use this command to set the restricted-role value of the port to TRUE.

Use the `no` parameter with this command to set the restricted-role value of the port to FALSE.

### Command Syntax

```
spanning-tree restricted-role
no spanning-tree restricted-role
```

### Parameters

None

### Default

By default, restricted-role value is FALSE

### Command Mode

Interface mode

### Applicability

This command was introduced before OcNOS version 1.3.

### Example

```
#configure terminal
(config)#interface eth0
(config-if)#spanning-tree restricted-role
```

---

## spanning-tree restricted-tcn

Use this command to set the restricted TCN value of the port to TRUE.

Use the `no` parameter with this command to set the restricted TCN value of the port to FALSE.

### Command Syntax

```
spanning-tree restricted-tcn
no spanning-tree restricted-tcn
```

### Parameters

None

### Default

By default, restricted TCN value is FALSE

### Command Mode

Interface mode

### Applicability

This command was introduced before OcNOS version 1.3.

### Example

```
#configure terminal
(config)#interface eth0
(config-if)#spanning-tree restricted-tcn
```

---

## spanning-tree te-msti configuration

This command is used to put the terminal into the `te-msti` configuration mode.

After creating a bridge instance and adding VLAN to that bridge instance, use this command to enter `te-msti` configuration mode.

### Command Syntax

```
spanning-tree te-msti configuration
```

### Parameters

None

### Default

No default value is specified

### Command Mode

Configure mode

### Applicability

This command was introduced before OcNOS version 1.3.

### Examples

```
#configure terminal
(config)#spanning-tree te-msti configuration
(config-te-msti)#
```

---

## storm-control

Use this command to set the rising threshold level for broadcast, multicast, or destination lookup failure traffic. The storm control action occurs when traffic utilization reaches this level.

Storm control is used to block the forwarding of unnecessary flooded traffic. A packet storm occurs when a large number of broadcast packets are received on a port. Forwarding these packets can cause the network to slow down or time out.

Storm-control is a physical interface property and when configured on port-channel storm-control is applied on each physical member port and therefore the actual value is the configured value multiplied by the number of active member interfaces.

Use the `no` form of this command to disable storm control.

Note: Minimum granularity for storm-control is 64kbps.

Note: Storm Discard notification is sent in case of packet discards but not based on configuration.

### Command Syntax

```
storm-control (broadcast|multicast|dlf) (level LEVEL | <0-4294967294>
(kbps|mbps|gbps))
no storm-control (broadcast|multicast|dlf)
```

### Parameters

<code>broadcast</code>	Broadcast rate limiting.
<code>multicast</code>	Multicast rate limiting.
<code>dlf</code>	Destination lookup failure limiting.
<code>level</code>	Sets the percentage of the threshold.
LEVEL	The percentage of the threshold.
<0-4294967294>	Sets absolute threshold value <0-1000000000>
kbps	specifies the units of Kilobits per second.
mbps	specifies the units of Megabits per second.
gbps	specifies the units of Gigabits per second.
fps	specifies the units of Frames per second.

Note: Use value for absolute threshold value parameter in multiples of 64 kbps. Whether the unit of measure is kbps, mbps, or gbps, the value must be divisible by 64 (such as "99.968 mbps").

### Default

By default, storm control is disabled

### Limitations

Burst option is not supported with rate type "FPS" and FPS cannot be configured along with other types (KBPS,MBPS,GBPS).

### Command Mode

Interface mode

**Applicability**

This command was introduced before OcnOS version 1.3.

**Examples**

```
#configure terminal
(config)#interface eth0
(config-if)#storm-control broadcast level 30

(config)#interface eth0
(config-if)#storm-control multicast level 30

(config)#interface eth0
(config-if)#storm-control multicast 64 mbps

(config)#interface eth0
(config-if)#no storm-control multicast

OcnOS(config-if)#storm-control multicast 50 kbps
%% Value applicable in hardware is 64.000 kbps

OcnOS(config-if)#storm-control multicast 0 kbps

OcnOS(config-if)#storm-control multicast 64 kbps

OcnOS(config-if)#storm-control multicast 100 kbps
%% Value applicable in hardware is 64.000 kbps

OcnOS(config-if)#storm-control multicast 130 kbps
%% Value applicable in hardware is 128.000 kbps

OcnOS(config-if)#storm-control multicast 130 mbps
%% Value applicable in hardware is 129.984 mbps
(config)#int xe1/1
(config-if)#switchport
(config-if)#storm-control multicast 100 mbps
%% Value applicable in hardware is 99.968 mbps

#show storm-control xe1/1
*The hardware applicable value is displayed
Port          BcastLevel    McastLevel    DlfLevel      Discards
xe1/1         100.0000%     99.968 mbps   100.0000%     0

#show run int xe1/1
!
interface xe1/1
  switchport
  storm-control multicast 100 mbps

(config-if)#int po4
(config-if)#switchport
#show storm-control po4
*The hardware applicable value is displayed
Port          BcastLevel    McastLevel    DlfLevel      Discards
po4           219.968 mbps  100.0000%     100.0000%     0
#
OcnOS#con t
```

```
Enter configuration commands, one per line.  End with CNTL/Z.
OcNOS(config)#int xe64/2
OcNOS(config-if)#switchport
OcNOS(config-if)#bridge-group 1
OcNOS(config-if)#switchport mode trunk
OcNOS(config-if)#switchport trunk allowed vlan add 2
OcNOS(config-if)#storm-control broadcast 1000 fps
OcNOS(config-if)#storm-control multicast 2000 fps
OcNOS(config-if)#storm-control dlf 5000 fps
OcNOS(config-if)#comm
%% Value applicable in hardware is 1000.000 fps

%% Value applicable in hardware is 2000.000 fps

%% Value applicable in hardware is 5000.000 fps

OcNOS(config-if)#end

OcNOS#show runn int xe64/2
!
interface xe64/2
  switchport
  bridge-group 1
  switchport mode trunk
  switchport trunk allowed vlan add 2
  storm-control broadcast 1000 fps
  storm-control multicast 2000 fps
  storm-control dlf 5000 fps
  load-interval 30
!
```

**Note:**

- The warning message appears only for the applicable value in multiples of 64 kbps.
- show running-config command displays the value that was entered by user.
- show storm-control displays the actual configured value. If the configured value is from 1-64 kbps, the configured value is treated as 64, similarly from 100-127 value the configured value is dropped to 64 kbps.
- For example, values configured from
  - 1-64 kbps becomes 64 kbps,
  - 100 kbps becomes 64 kbps,
  - 130 kbps becomes 128 kbps,
  - 200 kbps becomes 192 kbps so on.

---

## show storm-control

Use the command to verify the BUM rate limit configured.

Note: Drop statistics for BUM rate limiting is not supported on Qumran.

### Command Syntax

```
show storm-control (INTERFACE-NAME|)
```

### Example

```
OcNOS#sh storm-control xe2
*The hardware applicable value is displayed
Port          BcastLevel    McastLevel    DlfLevel      Discards
xe2           100.0000%    100.0000%    100.0000%    0
```

```
OcNOS#show storm-control
*The hardware applicable value is displayed
Port  BcastLevel (burst)    McastLevel (burst)    DlfLevel (burst)    Discards
xe64/2 1000.000 fps      2000.000 fps          5000.000 fps        7144132
```



---

## CHAPTER 4 RPVST+ Commands

---

This chapter contains the commands used for Rapid Per VLAN Spanning Tree (RPVST+). RPVST+ enables a bridge to inter-operate with Cisco RPVST+ switches.

RPVST+ uses the Multiple Spanning Tree Protocol (MSTP) with a single VLAN for each Multiple Spanning Tree instance (MSTI). The MST bridges can have different spanning-tree topologies for different VLANs inside a region of similar MST bridges. MSTP, like the Rapid Spanning Tree Protocol (RSTP), provides rapid reconfiguration capabilities and supports load balancing.

This chapter includes the following commands:

- [bridge vlan](#)
- [bridge vlan priority](#)
- [bridge-group vlan](#)
- [bridge protocol rpvst+](#)
- [bridge rapid-pervlan-spanning-tree](#)
- [show spanning-tree rpvst+](#)
- [spanning-tree rpvst+ configuration](#)
- [spanning-tree vlan restricted-role](#)
- [spanning-tree vlan restricted-tcn](#)

---

## bridge vlan

This command creates or deletes a mapping between an MSTI (Multiple Spanning Tree Instance) and a VLAN for RPVST+ operation. There can be only one VLAN per MST instance if the bridge is configured to run in RPVST+ mode.

The VLAN must have already been created. Spanning tree is enabled on each configured VLAN, and one instance of spanning-tree runs on each configured VLAN.

Use the `no` form of the command to disable this functionality.

### Command Syntax

```
bridge <1-32> vlan <2-4094>
no bridge <1-32> vlan <2-4094>
```

### Parameters

<1-32>	Bridge identifier.
<2-4094>	VLAN identifier.

### Command Mode

RPVST+ configure mode

### Applicability

This command was introduced before OcnOS version 1.3.

### Examples

```
#configure terminal
(config)#spanning-tree rpvst+ configuration
(config-rpvst+)#bridge 1 vlan 2
(config-rpvst+)#no bridge 1 vlan 2
```

---

## bridge vlan priority

This command sets the priority value for the spanning-tree on the bridge. The lower the priority of the VLAN on a bridge, the better the chances of the bridge becoming a root bridge, or a designated bridge for the VLAN.

Use the `no` form of this command to set the priority to its default (32,768).

### Command Syntax

```
bridge <1-32> vlan <2-4094> priority <0-61440>
no bridge <1-32> vlan <2-4094> priority
```

### Parameters

<1-32>	Bridge identifier.
<2-4094>	VLAN identifier.
<0-61440>	Bridge priority for the common instance. Set the priority in increments of 4096. A lower priority indicates greater likelihood of becoming root.

### Default

By default, priority for each VLAN is 32,768

### Command Mode

Configure mode

### Applicability

This command was introduced before OcnOS version 1.3.

### Examples

```
#configure terminal
(config)#bridge 1 vlan 2 priority 80
(config)#no bridge 1 vlan 10 priority
```

## bridge-group vlan

Use this command to assign a Rapid Per-VLAN Spanning Tree (RPVST+) instance to a port.

RPVST+ uses port priority as a tiebreaker to determine which port should forward frames for a particular LAN, or which port should be the root port for a VLAN. A lower value implies a better priority. In the case of the same priority, the interface index serves as the tiebreaker, with a lower-numbered interface being preferred over others.

Use the `no` parameter with this command to remove an RPVST+ instance from this port.

### Command Syntax

```
bridge-group <1-32> vlan <2-4094>
bridge-group <1-32> vlan <2-4094> path-cost <1-200000000>
bridge-group <1-32> vlan <2-4094> priority <0-240>
no bridge-group <1-32> vlan <2-4094>
no bridge-group <1-32> vlan <2-4094> path-cost
no bridge-group <1-32> vlan <2-4094> priority
```

### Parameters

<1-32>	Bridge group identifier.
<2-4094>	VLAN identifier.
<1-200000000>	Cost of a path associated with the interface.
<0-240>	Port priority. A lower priority indicates greater likelihood of the interface becoming a root. Set the priority only in increments of 16.

### Command Mode

Interface mode

### Applicability

This command was introduced before OcnOS version 1.3.

### Examples

```
#configure terminal
(config)#interface eth1
(config-if)#bridge-group 1 vlan 10

(config)#interface eth1
(config-if)#bridge-group 1 vlan 10 path-cost 1000

(config-if)#no bridge-group 1 vlan 10 path-cost

(config)#interface eth1
(config-if)#bridge-group 1 vlan 10 priority 240

(config-if)#no bridge-group 1 vlan 10 priority
```

---

## bridge protocol rpvst+

Use this command to enable Rapid Per-VLAN Spanning Tree on a bridge.

### Command Syntax

```
bridge <1-32> protocol rpvst+
```

### Parameter

<1-32>                    Bridge identifier.

### Command Mode

Configure mode

### Applicability

This command was introduced before OcnOS version 1.3.

### Example

```
#configure terminal  
(config)#bridge 1 protocol rpvst+
```

---

## bridge rapid-pervlan-spanning-tree

Use this command to enable Rapid Per-VLAN Spanning Tree (RPVST+) globally on a bridge.

Use the `no` form of this command to disable RPVST+ globally on a bridge.

### Command Syntax

```
bridge <1-32> rapid-pervlan-spanning-tree enable
no bridge <1-32> rapid-pervlan-spanning-tree enable (bridge-blocked|bridge-
forward|)
```

### Parameters

`<1-32>` Bridge identifier.

`bridge-blocked` Put ports of the bridge in the blocked state (default).

`bridge-forward` Put ports of the bridge in the forwarding state.

### Default

By default, this feature is enabled.

For the `no` form of this command, `bridge-blocked` is the default.

### Command Mode

Configure mode

### Applicability

This command was introduced before OcnOS version 1.3.

### Examples

```
#configure terminal
(config)#bridge 1 rapid-pervlan-spanning-tree enable

(config)#no bridge 1 rapid-pervlan-spanning-tree enable bridge-forward
```

---

## show spanning-tree rpvst+

Use this command to display RPVST information.

### Command Syntax

```
show spanning-tree rpvst+
show spanning-tree rpvst+ config
show spanning-tree rpvst+ detail
show spanning-tree rpvst+ detail interface IFNAME
show spanning-tree rpvst+ interface IFNAME
show spanning-tree rpvst+ vlan <1-4094>
show spanning-tree rpvst+ vlan <1-4094> interface IFNAME
```

### Parameters

config	Display configuration information.
detail	Display detailed information.
IFNAME	Display interface information.
<1-4094>	Display VLAN information

### Command Mode

Exec mode and Privileged Exec mode

### Applicability

This command was introduced before OcnOS version 1.3.

### Example

The following displays output of this command without any parameters.

```
#show spanning-tree rpvst+
% 1: Bridge up - Spanning Tree Enabled - topology change detected
% 1: Root Path Cost 0 - Root Port 0 - Bridge Priority 32768
% 1: Forward Delay 15 - Hello Time 2 - Max Age 20 - Transmit Hold Count 6
% 1: Root Id 8001525400b092de
% 1: Bridge Id 8001525400b092de
% 1: last topology change Wed Mar 28 02:31:50 2018
% 1: 1 topology change(s) - last topology change Wed Mar 28 02:31:50 2018

% 1: portfast bpdu-filter disabled
% 1: portfast bpdu-guard disabled
% 1: portfast errdisable timeout disabled
% 1: portfast errdisable timeout interval 300 sec
% eth1: Port Number 3 - Ifindex 3 - Port Id 0x8003 - Role Designated - State Forwarding
% eth1: Designated External Path Cost 0 -Internal Path Cost 0
% eth1: Configured Path Cost 200000 - Add type Explicit ref count 2
% eth1: Designated Port Id 0x8003 - Priority 128 -
```

## RPVST+ Commands

---

```
% eth1: Root 8001525400b092de
% eth1: Designated Bridge 8001525400b092de
% eth1: Message Age 0 - Max Age 20
% eth1: Hello Time 2 - Forward Delay 15
% eth1: Forward Timer 0 - Msg Age Timer 0 - Hello Timer 3 - topo change timer 0
% eth1: forward-transitions 1
% eth1: Version Rapid Spanning Tree Protocol - Received None - Send RSTP
% eth1: No portfast configured - Current portfast off
% eth1: bpdu-guard default - Current bpdu-guard off
% eth1: bpdu-filter default - Current bpdu-filter off
% eth1: no root guard configured - Current root guard off
% eth1: Configured Link Type point-to-point - Current point-to-point
% eth1: No auto-edge configured - Current port Auto Edge off
%
%
% Instance          VLAN
% 0:                1, 4-10
% 1:                2
% 2:                3
```

The following displays output of this command with the `config` parameter.

```
#show spanning-tree rpvst+ config
```

```
%
% RPVST Configuration Information for bridge 1 :
%-----
% Format Id       : 0
% Name           : Default
% Revision Level : 0
% Digest         : 0xB41829F9030A054FB74EF7A8587FF58D
%-----
```

```
#show spanning-tree rpvst+ detail
```

```
% 1: Bridge up - Spanning Tree Enabled - topology change detected
% 1: Root Path Cost 0 - Root Port 0 - Bridge Priority 32768
% 1: Forward Delay 15 - Hello Time 2 - Max Age 20 - Transmit Hold Count 6
% 1: Root Id 8001525400b092de
% 1: Bridge Id 8001525400b092de
% 1: last topology change Wed Mar 28 02:31:50 2018
% 1: 1 topology change(s) - last topology change Wed Mar 28 02:31:50 2018

% 1: portfast bpdu-filter disabled
% 1: portfast bpdu-guard disabled
% 1: portfast errdisable timeout disabled
% 1: portfast errdisable timeout interval 300 sec
% eth1: Port Number 3 - Ifindex 3 - Port Id 0x8003 - Role Designated - State Forwarding
% eth1: Designated External Path Cost 0 -Internal Path Cost 0
% eth1: Configured Path Cost 200000 - Add type Explicit ref count 2
% eth1: Designated Port Id 0x8003 - Priority 128 -
% eth1: Root 8001525400b092de
```



```
% eth1: Designated Bridge 8001525400b092de
% eth1: Message Age 0 - Max Age 20
% eth1: Hello Time 2 - Forward Delay 15
% eth1: Forward Timer 0 - Msg Age Timer 0 - Hello Timer 1 - topo change timer 0
% eth1: forward-transitions 1
% eth1: Version Rapid Spanning Tree Protocol - Received None - Send RSTP
% eth1: No portfast configured - Current portfast off
% eth1: bpdu-guard default - Current bpdu-guard off
% eth1: bpdu-filter default - Current bpdu-filter off
% eth1: no root guard configured - Current root guard off
% eth1: Configured Link Type point-to-point - Current point-to-point
% eth1: No auto-edge configured - Current port Auto Edge off
%

% Instance 1: Vlans: 2
% eth1: Port Number 3 - Ifindex 3 - Port Id 0x8003 - Role Designated - State
Forwarding
% eth1: Designated Internal Path Cost 0 - Designated Port Id 0x8003
% eth1: Configured Internal Path Cost 200000
% eth1: Configured External Path cost 200000
% eth1: Configured Internal Priority 128
% eth1: Configured External Priority 128
% eth1: Designated Root 8002525400b092de
% eth1: Designated Bridge 8002525400b092de
% eth1: Message Age 0 - Max Age 20
% eth1: Hello Time 2 - Forward Delay 15
% eth1: Forward Timer 0 - Msg Age Timer 0 - Hello Timer 1

#show spanning-tree rpvst+ vlan 2
% vlan 2 Instance 1 configured
% 1: Root Path Cost 0 - Root Port 0 - Bridge Priority 32768
% 1: Root Id 8002525400b092de
% 1: Bridge Id 8002525400b092de
% eth1: Port Number 3 - Ifindex 3 - Port Id 0x8003 - Role Designated - State
Forwarding
% eth1: Designated Internal Path Cost 0 - Designated Port Id 0x8003
% eth1: Configured Internal Path Cost 200000
% eth1: Configured External Path cost 200000
% eth1: Configured Internal Priority 128
% eth1: Configured External Priority 128
% eth1: Designated Root 8002525400b092de
% eth1: Designated Bridge 8002525400b092de
% eth1: Message Age 0 - Max Age 20
% eth1: Hello Time 2 - Forward Delay 15
% eth1: Forward Timer 0 - Msg Age Timer 0 - Hello Timer 1
%

%

#show spanning-tree rpvst+ vlan 2 interface eth1
% 1: Root Path Cost 0 - Root Port 0 - Bridge Priority 32768
% 1: Root Id 8002525400b092de
```

## RPVST+ Commands

---

```
% 1: Bridge Id 8002525400b092de
% eth1: Port Number 3 - Ifindex 3 - Port Id 0x8003 - Role Designated - State
Forwarding
% eth1: Designated Internal Path Cost 0 - Designated Port Id 0x8003
% eth1: Configured Internal Path Cost 200000
% eth1: Configured External Path cost 200000
% eth1: Configured Internal Priority 128
% eth1: Configured External Priority 128
% eth1: Designated Root 8002525400b092de
% eth1: Designated Bridge 8002525400b092de
% eth1: Message Age 0 - Max Age 20
% eth1: Hello Time 2 - Forward Delay 15
% eth1: Forward Timer 0 - Msg Age Timer 0 - Hello Timer 0
%
```

---

## spanning-tree rpvst+ configuration

Use this command to enter RPVST+ configuration mode after creating a bridge and adding a VLAN to that bridge. Internally, an RSTP Instance is created for each configured VLAN.

### Command Syntax

```
spanning-tree rpvst+ configuration
```

### Parameters

None

### Command Mode

Configure mode

### Applicability

This command was introduced before OcNOS version 1.3.

### Example

```
#configure terminal  
(config)#spanning-tree rpvst+ configuration  
(config-rpvst+)#
```

---

## spanning-tree vlan restricted-role

Use this command to restrict the role of the interface.

Use the `no` form of this command to not restrict the role of the interface.

### Command Syntax

```
spanning-tree vlan <2-4094> restricted-role
no spanning-tree vlan <2-4094> restricted-role
```

### Parameters

<2-4094>            VLAN identifier.

### Default

The default is to not restrict the role of the interface

### Command Mode

Interface mode

### Applicability

This command was introduced before OcnOS version 1.3.

### Example

```
#configure terminal
(config)#interface eth0
(config-if)#spanning-tree vlan 10 restricted-role
```

---

## spanning-tree vlan restricted-tcn

Use this command to restrict propagating topology change notifications (TCNs) from the interface.

Use the `no` form of this command to not restrict propagating TCNs from the interface.

### Command Syntax

```
spanning-tree vlan <2-4094> restricted-tcn
no spanning-tree vlan <2-4094> restricted_tcn
```

### Parameters

<2-4094>            VLAN identifier.

### Default

The default is to not restrict propagating TCNs

### Command Mode

Interface mode

### Applicability

This command was introduced before OcnOS version 1.3.

### Example

```
#configure terminal
(config)#interface eth0
(config-if)#spanning-tree vlan 10 restricted-tcn
(config-if)#no spanning-tree vlan 10 restricted_tcn
```



---

## CHAPTER 5 Link Aggregation Commands

---

This chapter describes the link aggregation commands.

- `channel-group mode`
- `clear lacp`
- `debug lacp`
- `interface po`
- `interface sa`
- `lacp destination-mac`
- `lacp force-up`
- `lacp port-priority`
- `lacp system-priority`
- `lacp timeout`
- `port-channel load-balance`
- `port-channel min-bandwidth - dynamic LAG min-bandwidth`
- `port-channel min-links - dynamic LAG min-links`
- `port-channel min-bandwidth - static LAG min-bandwidth`
- `port-channel min-links - static LAG min-links`
- `show debugging lacp`
- `show etherchannel`
- `show lacp sys-id`
- `show lacp-counter`
- `show port etherchannel`
- `show static-channel-group`
- `show static-channel load-balance`
- `snmp restart lacp`
- `static-channel-group`

## channel-group mode

Use this command to add an interface to an existing link aggregation group.

After you execute this command, the interface loses its properties and takes the properties of the aggregated interface.

Use the `no` parameter with this command to remove an interface from a dynamic link aggregation group. When you remove an interface from a LAG, the interface acquires the default interface properties.

### Command Syntax

```
channel-group <1-16383> mode (active|passive)
no channel-group
```

### Parameters

<1-16383>	Specify a channel group number (with DRNI).
mode	Specify a channel mode.
active	Enable LACP negotiation.
passive	Disable LACP negotiation.

### Command Mode

Interface mode

### Applicability

This command was introduced before OcNOS version 1.3.

### Examples

```
#configure terminal
(config)#interface xe1
(config-if)#switchport
(config-if)#channel-group 1 mode active
(config-if)#exit
```

```
#sh run in po1
!
interface po1
switchport
port-channel load-balance src-dst-mac
```

The is an example of `no channel-group`:

```
#configure terminal
(config)#interface xe1
(config-if)#switchport
(config-if)#no channel-group
(config-if)#exit
```

```
#sh run in xe1
!
interface xe1
!
#sh run in po1
!
```



```
interface po1
  switchport
  port-channel load-balance src-dst-mac
!
```

---

## clear lacp

Use this command to clear the counters of all LACP aggregators or a given LACP aggregator.

### Command Syntax

```
clear lacp <1-16383> counters
clear lacp counters
```

### Parameters

<1-16383>            Clears a channel-group number.

### Command Mode

Exec mode and Pr<1-16383>ivileged Exec mode

### Applicability

This command was introduced before OcNOS version 1.3.

### Example

```
#clear lacp 2 counters
```

## debug lacp

Use this command to enable LACP debugging.

Use the `no` parameter with this command to disable debugging.

### Command Syntax

```
debug lacp (event|cli|timer|packet|sync|ha|all|rx|tx)
no debug lacp (event|cli|timer|packet|sync|ha|allrx|tx)
undebug all
```

### Parameters

<code>all</code>	Enables all LACP debugging.
<code>cli</code>	Echo commands to console.
<code>event</code>	Sets the debug options for LACP events.
<code>ha</code>	Echo High availability events to console.
<code>packet</code>	Sets the debug option for LACP packets.
<code>sync</code>	Echo synchronization to console.
<code>timer</code>	Echo timer expiry to console.
<code>rx</code>	Echo receiving of lacpdus to console.
<code>tx</code>	Echo transmission of lacpdus to console.

### Command Mode

Exec mode and Privileged Exec mode

### Applicability

This command was introduced before OcNOS version 1.3.

### Example

```
#debug lacp all
```

---

## interface po

Use this command to create a dummy dynamic link aggregate interface (by default an L3 LAG interface).

Use the `no` form of this command to remove a dynamic link aggregate group and also it remove the properties of the `po` from all member ports.

Note: Switchport/routed mode needs to be set for the PO before adding member ports to it.

### Command Syntax

```
interface po<1-16383>
no interface po<1-16383>
```

### Parameters

<1-16383>            Channel group number

### Default

By default, interface `po` is L3 LAG interface

### Command Mode

Configuration mode

### Applicability

This command was introduced before OcnOS version 1.3.

### Example

```
#configure terminal
(config)#interface po1
(config-if)#switchport
(config-if)#exit
```

---

## interface sa

Use this command to create a dummy static link aggregate interface (by default an L3 LAG interface) and to add an interface to an existing static link aggregation group.

Use the `no` form of this command to remove a static link aggregate group and also remove the properties of the ports from all member ports.

### Command Syntax

```
interface sa<1-16383>  
no interface sa<1-16383>
```

### Parameters

<1-16383>            Channel group number.

### Default

By default, interface sa is L3 LAG interface

### Command Mode

Configuration mode

### Applicability

This command was introduced before OcnOS version 1.3.

### Example

```
#configure terminal  
(config)#interface sa1  
(config-if)#switchport  
(config-if)#exit
```

---

## lacp destination-mac

Use this command to set the address type to use for sending LACPDU (Link Aggregation Control Protocol Data Units).

Note: The interface must be an aggregation port.

Use the `no` form of this command to set the address type to its default (multicast group address).

### Command Syntax

```
lacp destination-mac (customer-bridge-group-address | multicast-group-address |
non-tmpr-group-address)
no lacp destination-mac
```

### Parameters

```
customer-bridge-group-address
    Customer bridge group address
multicast-group-address
    Multicast group address (default)
non-TPMR-group-address
    Non-Two-Port Media Access Control Relay (TPMR) group address
```

### Default

By default, `lacp destination-mac` is `multicast-group-address`

### Command Mode

Interface mode

### Applicability

This command was introduced before OcnOS version 1.3.

### Example

```
#config terminal
(config)#interface eth1
(config-if)#lacp destination-mac customer-bridge-group-address
```

## lacp force-up

Use this command to make a port immediately begin forwarding packets and not wait for an LACPDU. After you execute this command, the member port is forcefully up even if LACP is not in sync (only if no other member in the aggregator is in sync).

If a force-up port stops receiving LACPDUs, the port ignores the time-out and remains in operation.

This command can be configured on one member interface of a port channel.

Note: This command can only be given after executing the [channel-group mode](#) command on an interface. Force-up mode is not supported for LACP passive mode.

Note: For MLAG, only configure a force-up port on either on the master node or the slave node to prevent traffic drops/loops.

Use the `no` form of this command to disable force-up mode.

### Command Syntax:

```
lacp force-up
no lacp force-up
```

### Parameters

None

### Default

By default, LACP force-up mode is disabled.

### Command Mode

Interface mode

### Applicability

This command was introduced in OcNOS version 1.3.6.

### Example

```
#configure terminal
(config)#interface xe1
(config-if)#switchport
(config-if)#channel-group 1 mode active
(config-if)#lacp force-up
(config-if)#exit
```

---

## lacp port-priority

Use this command to set the priority of a channel. Channels are selected for aggregation based on their priority with the higher priority (numerically lower) channels selected first.

Use the `no` parameter with this command to set the priority of port to the default value (32768).

### Command Syntax

```
lacp port-priority <1-65535>
no lacp port-priority
```

### Parameters

<1-65535> Specify the LACP port priority.

### Default

By default, lacp port priority is 32768

### Command Mode

Interface mode

### Applicability

This command was introduced before OcNOS version 1.3.

### Example

```
#configure terminal
(config)#interface eth0
(config-if)#lacp port-priority 34
```



---

## lacp system-priority

Use this command to set the LACP system priority. This priority determines the system responsible for resolving conflicts in the choice of aggregation groups.

Note: A lower numerical value has a higher priority.

Use the `no` parameter with this command to set the system priority to its default value (32768).

### Command Syntax

```
lacp system-priority <1-65535>
no lacp system-priority
```

### Parameters

<1-65535>            System priority.

### Default

By default, system priority is 32768

### Command Mode

Configure mode

### Applicability

This command was introduced before OcnOS version 1.3.

### Example

```
#configure terminal
(config)#lacp system-priority 6700
```

---

## lacp timeout

Use this command to set either a short or long timeout value on a port. The timeout value is the number of seconds before invalidating a received LACP data unit (DU).

### Command Syntax

```
lacp timeout (short|long)
```

### Parameters

short                    LACP short timeout. 3 seconds.

long                    LACP long timeout. 90 seconds.

Note: Short: With this mode, BPDU will be sent at Fast\_Periodic\_Time of 1 second interval. It will timeout, before invalidating received LACPDU, after 3xFast\_Periodic\_Time(3seconds),

Long: With this mode, BPDU will be sent at Slow\_Periodic\_Time of 30 seconds intervals. It will timeout, before invalidating received LACPDU, after 3xSlow\_Periodic\_Time(90seconds)

### Default

By default, lacp timeout is long

### Command Mode

Interface mode

### Applicability

This command was introduced before OcNOS version 1.3.

### Example

The following sets the LACP short timeout on a port.

```
#configure terminal
(config)#interface eth0
(config-if)#lacp timeout short
```

---

## port-channel load-balance

Use this command to configure LACP port-channel load-balancing and set port-selection criteria (PSC) for an interface. Use the `no` option with this command to remove the load-balancing configuration and unset PSC.

### Command Syntax

```
port-channel load-balance (dst-mac|src-mac|src-dst-mac|dst-ip|src-ip|src-dst-  
ip|dst-port|src-port|src-dst-port|rtag7)  
no port-channel load-balance
```

### Parameters

<code>dst-ip</code>	Destination IP address-based load balancing.
<code>dst-mac</code>	Destination MAC address-based load balancing.
<code>dst-port</code>	Destination TCP/UDP address-based load balancing.
<code>src-dst-ip</code>	Source and Destination IP address-based load balancing.
<code>src-dst-mac</code>	Source and Destination MAC address-based load balancing.
<code>src-dst-port</code>	Source and Destination TCP/UDP address-based load balancing.
<code>src-ip</code>	Source IP address-based load balancing.
<code>src-mac</code>	Source MAC address-based load balancing.
<code>src-port</code>	Source port address-based load balancing.
<code>rtag7</code>	Hashing based on packet type. IP - IP/Layer4 header, L2 - Layer2 header packet.

### Default

By default load balance is `src-dst-ip` for L3 port and `src-dst-mac` for L2 port.

### Command Mode

Interface mode

### Applicability

This command was introduced before OcNOS version 1.3.

### Example

```
#configure terminal  
(config)#interface po1  
(config-if)#port-channel load-balance src-dst-mac
```

---

## port-channel min-bandwidth - dynamic LAG min-bandwidth

Use this command to set the minimum number of aggregated bandwidth that need to be up in the LAG(PO) interface. When the minimum number of bandwidth are configured for a LAG(PO), if the active links bandwidth for that interface become less than the configured value, then the whole LAG(PO) is brought down. When the number of active links bandwidth become the same or more than the configured value, then the whole LAG is restored.

Use the no form of this command to remove the minimum number of aggregated bandwidth that need to be up in the LAG interface.

Note: The minimum number of aggregated bandwidth should be same across both ends of an aggregation interface. If not configured, then on one of the nodes the LAG port will be treated as up and on the other as down and traffic will be discarded.

Note: When a LAG port is moved to the down state because it does not have the minimum number of required bandwidth up and running, then the traffic on the remaining interfaces in the LAG will be counted as port-block discards.

Note: The [port-channel min-links - dynamic LAG min-links](#) feature and this feature are mutually exclusive. Both configurations cannot exist at the same time.

### Command Syntax

```
port-channel min-bandwidth <1-1000>g
no port-channel min-bandwidth
```

### Parameters

<1-1000>g            for 1 to 1000 gigabits/s

### Default

By default, port channel min- bandwidth is disabled.

### Command Mode

Interface mode

### Applicability

This command was introduced from OcNOS version 1.3.8

### Example

```
#configure terminal
(config)#interface po1
(config-if)#port-channel min-bandwidth 10g
```

---

## port-channel min-links - dynamic LAG min-links

Use this command to set the minimum number of aggregated links that need to be up in the LAG(PO) interface. When the minimum number of links are configured for a LAG(PO), if the active links for that interface become less than the configured value, then the whole LAG(PO) is brought down. When the number of active links become the same or more than the configured value, then the whole LAG is restored.

Use the no form of this command to remove the minimum number of aggregated links that need to be up in the LAG interface.

Note: The minimum number of aggregated links should be same across both ends of an aggregation interface. If not configured, then on one of the nodes the LAG port will be treated as up and on the other as down and traffic will be discarded.

Note: When a LAG port is moved to the down state because it does not have the minimum number of required links up and running, then the traffic on the remaining interfaces in the LAG will be counted as port-block discards.

Note: The [show debugging lacp](#) feature and this feature are mutually exclusive. Both configurations cannot exist at the same time.

### Command Syntax

```
port-channel min-links <2-32>
no port-channel min-links
```

### Parameters

<2-32>                    Minimum number of links

### Default

By default, port channel min-link is disabled.

### Command Mode

Interface mode

### Applicability

This command was introduced from OcNOS version 1.3.8

### Example

```
#configure terminal
(config)#interface po1
(config-if)#port-channel min-links 10
(config-if)#exit
```

---

## port-channel min-bandwidth - static LAG min-bandwidth

Use this command to set the minimum number of aggregated bandwidth that need to be up in the LAG(SA) interface. When the minimum number of bandwidth are configured for a LAG(SA), if the active links bandwidth for that interface become less than the configured value, then the whole LAG(SA) is brought down. When the number of active links bandwidth become the same or more than the configured value, then the whole LAG is restored.

Use the no form of this command to remove the minimum number of aggregated bandwidth that need to be up in the LAG interface.

Note: The minimum number of aggregated bandwidth should be same across both ends of an aggregation interface. If not configured, then on one of the nodes the LAG port will be treated as up and on the other as down and traffic will be discarded.

Note: When a LAG port is moved to the down state because it does not have the minimum number of required bandwidth up and running, then the traffic on the remaining interfaces in the LAG will be counted as port-block discards.

Note: The [port-channel min-links - static LAG min-links](#) feature and this feature are mutually exclusive. Both configurations cannot exist at the same time.

### Command Syntax

```
port-channel min-bandwidth <1-1000>g
no port-channel min-bandwidth
```

### Parameters

<1-1000>g            for 1 to 1000 gigabits/s

### Default

By default, port channel min- bandwidth is disabled.

### Command Mode

Interface mode

### Applicability

This command was introduced from OcNOS version 1.3.8

### Example

```
#configure terminal
(config)#interface sa1
(config-if)#port-channel min-bandwidth 10g
```

---

## port-channel min-links - static LAG min-links

Use this command to set the minimum number of aggregated links that need to be up in the LAG(SA) interface. When the minimum number of links are configured for a LAG(SA), if the active links for that interface become less than the configured value, then the whole LAG(SA) is brought down. When the number of active links become the same or more than the configured value, then the whole LAG is restored.

Use the no form of this command to remove the minimum number of aggregated links that need to be up in the LAG interface.

Note: The minimum number of aggregated links should be same across both ends of an aggregation interface. If not configured, then on one of the nodes the LAG port will be treated as up and on the other as down and traffic will be discarded.

Note: When a LAG port is moved to the down state because it does not have the minimum number of required links up and running, then the traffic on the remaining interfaces in the LAG will be counted as port-block discards.

Note: The [port-channel min-bandwidth - static LAG min-bandwidth](#) feature and this feature are mutually exclusive. Both configurations cannot exist at the same time.

### Command Syntax

```
port-channel min-links <2-32>
no port-channel min-links
```

### Parameters

<2-32>                    Minimum number of links

### Default

By default, port channel min-link is disabled.

### Command Mode

Interface mode

### Applicability

This command was introduced from OcNOS version 1.3.8

### Example

```
#configure terminal
(config)#interface sa1
(config-if)#port-channel min-links 10
(config-if)#exit
```

---

## show debugging lacp

Use this command to display the status of the debugging of the LACP system.

### Command Syntax

```
show debugging lacp
```

### Parameters

None

### Command Mode

Exec and Privileged Exec mode

### Applicability

This command was introduced before OcNOS version 1.3.

### Example

```
#show debugging lacp
```

```
LACP debugging status:  
LACP timer debugging is on
```



---

## show etherchannel

Use this command to display information about link aggregation groups.

### Command Syntax

```
show etherchannel
show etherchannel <1-16383>
```

With MLAG:

```
show etherchannel (<1-16383>|) detail
show etherchannel (<1-16383>|) load-balance
show etherchannel (<1-16383>|) summary
```

Without MLAG:

```
show etherchannel (<1-16383>|) detail
show etherchannel (<1-16383>|) load-balance
show etherchannel (<1-16383>|) summary
```

### Parameters

<1-16383>	Specify channel-group number.
detail	Specify detailed etherchannel information.
limit	Specify channel limit.
detail	Specify detailed etherchannel information.
Max Aggregators	Maximum number of aggregators supported is 128.
Max Ports in Aggregator	Maximum number of ports supported in aggregator 16.
load-balance	Specify load balancing.
summary	Specify Etherchannel summary information.

### Command Mode

Exec mode and Privileged Exec mode

### Applicability

This command was introduced before OcnOS version 1.3.

### Example

```
#show etherchannel summary
% Aggregator po1 185
% Aggregator Type: Layer3
% Admin Key: 0001 - Oper Key 0001
% Link: eth3 (5) sync: 0
-----
% Aggregator po4 186
% Admin Key: 0004 - Oper Key 0004
% Link: eth2 (4) sync: 0
-----
% Aggregator po5 187
```

```

% Admin Key: 0005 - Oper Key 0005
% Link: eth1 (3) sync: 0

#show etherchannel detail
% Aggregator po1 185
% Aggregator Type: Layer3
% Mac address: 08:00:27:36:f5:7d
% Admin Key: 0001 - Oper Key 0001
% Actor LAG ID- 0x8000,08-00-27-fa-4b-0e,0x0001
% Receive link count: 0 - Transmit link count: 0
% Individual: 0 - Ready: 0
% Partner LAG ID- 0x0000,00-00-00-00-00-00,0x0000
% Link: eth3 (5) sync: 0
% Collector max delay: 5
-----
% Aggregator po4 186
% Mac address: 08:00:27:76:0c:57
% Admin Key: 0004 - Oper Key 0004
% Actor LAG ID- 0x8000,08-00-27-fa-4b-0e,0x0004
% Receive link count: 0 - Transmit link count: 0
% Individual: 0 - Ready: 1
% Partner LAG ID- 0x0000,00-00-00-00-00-00,0x0000
% Link: eth2 (4) sync: 0
% Collector max delay: 5
-----
% Aggregator po5 187
% Mac address: 08:00:27:2f:d5:ae
% Admin Key: 0005 - Oper Key 0005
% Actor LAG ID- 0x8000,08-00-27-fa-4b-0e,0x0005
% Receive link count: 0 - Transmit link count: 0
% Individual: 0 - Ready: 0
% Partner LAG ID- 0x0000,00-00-00-00-00-00,0x0000
% Link: eth1 (3) sync: 0
% Collector max delay: 5

```

Table 5-12 explains the show command output fields.

**Table 5-12: show etherchannel detail output**

Field	Description
Aggregator	Link aggregators name and ID number.
Mac address	Unique MAC address for link identification.
Admin Key	LACP administrative key – automatically configured value on each port configured to use LACP.
Oper Key	LACP operator key on Partner – automatically configured value on each port configured to use LACP.
Actor LAG ID	LAG ID consisting of MAC address plus aggregator ID number for this Actor.
Receive link count	The number of link received from the peer LAG.
Transmit link count	The number of links contained transmitted to the peer LAG.

**Table 5-12: show etherchannel detail output (Continued)**

<b>Field</b>	<b>Description</b>
Individual	The individual physical network interfaces or ports contained in the LAG.
Ready	The number of links in the active state on this Actor.
Partner LAG ID	Partner LAG ID consisting of MAC address plus aggregator ID number.
Link	Interface and ID number of the link.
sync	MAC address synchronization enables a MLAG Partner to forward Layer 3 packets arriving on this interfaces with either its own MAC address or its Partner's.
Collector max delay	Maximum period of wait time between sending of two subsequent Ethernet frames on a link.

---

## show lacp sys-id

Use this command to display the LACP system identifier and priority.

### Command Syntax

```
show lacp sys-id
```

### Parameters

`sys-id`                    Display LACP system ID and priority

### Command Mode

Exec and Privileged Exec mode

### Applicability

This command was introduced before OcNOS version 1.3.

### Example

```
#show lacp sys-id
% System 8000,00-0e-0c-83-37-27
```

---

## show lacp-counter

Use this command to display the packet traffic on all ports of all present LACP aggregators, or a given LACP aggregator.

### Command Syntax

```
show lacp-counte
show lacp-counter <1-16383>
```

### Parameters

<1-16383>            Channel-group number

### Command Mode

Exec and Privileged Exec mode

### Applicability

This command was introduced before OcnOS version 1.3.

### Example

```
#show lacp-counter 555
```

Port	LACPDUs		Marker		Pckt err	
	Sent	Recv	Sent	Recv	Sent	Recv

---

## show port etherchannel

Use this command to display details about a PO and its members' interfaces or to display details of a single member interface of a PO.

### Command Syntax

```
show port etherchannel IFNAME
```

### Parameters

IFNAME                    Interface name

### Command Mode

Exec and Privileged Exec mode

### Applicability

This command was introduced before OcNOS version 1.3.

### Example

```
#show port etherchannel ce29/1
LAG ID                               : 0x8000,cc-37-ab-a0-89-ca,0x0002
Partner oper LAG ID                 : 0x8000,a8-2b-b5-38-1e-48,0x0004
Aggregator ID                        : 100002
  LACP link info                      : ce29/1 - 10001
  Periodic Transmission
  machine state                       : Slow periodic
  Receive machine state               : Current
  Mux machine state                   : Collecting/Distributing
  Actor Info :
  =====
  Actor Port priority                 : 0x8000 (32768)
  Admin key                           : 0x0002 (2) Oper key: 0x0002 (2)
  Physical admin key                  : (2)
  Actor Oper state                    : ACT:1 TIM:0 AGG:1 SYN:1 COL:1 DIS:1 DEF:0 EXP:0
  Actor Admin state                   : ACT:1 TIM:0 AGG:1 SYN:0 COL:0 DIS:0 DEF:1 EXP:0
  Partner Info:
  =====
  Partner oper port                   : 10009
  Partner link info                   : admin port 0
  Partner admin LAG ID                : 0x0000-00:00:00:00:0000
  Partner system priority             : admin:0x0000 - oper:0x8000
  Partner port priority               : admin:0x0000 - oper:0x8000
  Partner oper state                   : ACT:1 TIM:0 AGG:1 SYN:1 COL:1 DIS:1 DEF:0 EXP:0
  Partner admin state                  : ACT:0 TIM:0 AGG:1 SYN:0 COL:0 DIS:0 DEF:1 EXP:0

#show port etherchannel po2
LAG ID                               : 0x8000,cc-37-ab-a0-89-ca,0x0002
Partner oper LAG ID                 : 0x8000,a8-2b-b5-38-1e-48,0x0004
Aggregator ID                        : 100002
  LACP link info                      : ce29/1 - 10001
  Periodic Transmission
  machine state                       : Slow periodic
```

```

Receive machine state      : Current
Mux machine state        : Collecting/Distributing
Actor Info :
=====
Actor Port priority      : 0x8000 (32768)
Admin key                : 0x0002 (2) Oper key: 0x0002 (2)
Physical admin key      : (2)
Actor Oper state        : ACT:1 TIM:0 AGG:1 SYN:1 COL:1 DIS:1 DEF:0 EXP:0
Actor Admin state      : ACT:1 TIM:0 AGG:1 SYN:0 COL:0 DIS:0 DEF:1 EXP:0
Partner Info:
=====
Partner oper port       : 10009
Partner link info      : admin port 0
Partner admin LAG ID   : 0x0000-00:00:00:00:0000
Partner system priority : admin:0x0000 - oper:0x8000
Partner port priority  : admin:0x0000 - oper:0x8000
Partner oper state     : ACT:1 TIM:0 AGG:1 SYN:1 COL:1 DIS:1 DEF:0 EXP:0
Partner admin state    : ACT:0 TIM:0 AGG:1 SYN:0 COL:0 DIS:0 DEF:1 EXP:0

LACP link info         : ce30/1 - 10005
Periodic Transmission
machine state          : Slow periodic
Receive machine state  : Current
Mux machine state     : Collecting/Distributing
Actor Info :
=====
Actor Port priority    : 0x8000 (32768)
Admin key              : 0x0002 (2) Oper key: 0x0002 (2)
Physical admin key    : (2)
Actor Oper state      : ACT:1 TIM:0 AGG:1 SYN:1 COL:1 DIS:1 DEF:0 EXP:0
Actor Admin state     : ACT:1 TIM:0 AGG:1 SYN:0 COL:0 DIS:0 DEF:1 EXP:0
Partner Info:
=====
Partner oper port     : 10013
Partner link info    : admin port 0
Partner admin LAG ID : 0x0000-00:00:00:00:0000
Partner system priority : admin:0x0000 - oper:0x8000
Partner port priority : admin:0x0000 - oper:0x8000
Partner oper state   : ACT:1 TIM:0 AGG:1 SYN:1 COL:1 DIS:1 DEF:0 EXP:0
Partner admin state  : ACT:0 TIM:0 AGG:1 SYN:0 COL:0 DIS:0 DEF:1 EXP:0

```

Note: Most of the output of this command is duplicated in the [show etherchannel](#) command (see also the 802.3ad specification). The output of the `show port etherchannel` command is primarily a list of state machine values. An explanation of the state machine bits follows. See [Figure 5-45](#).

[Table 5-13](#) explains the show command output fields.

**Table 5-13: show port etherchannel detailed output**

Entry	Description
Actor/Partner state	The Actor's and Partner's state variables, encoded as individual bits within a single octet.
ACT	LACP_Activity is encoded in bit 0. Active LACP is encoded as a 1; Passive LACP as a 0.

**Table 5-13: show port etherchannel detailed output (Continued)**

Entry	Description
TIM	LACP_Timeout is encoded in bit 1. Short Timeout is encoded as a 1; Long Timeout as a 0.
AGG	Aggregability is encoded in bit 2. Aggregatable is encoded as a 1; Individual is encoded as a 0.
SYN	Synchronization is encoded in bit 3. In_Sync is encoded as a 1; Out_Of_Sync is encoded as a 0.
COL	Collecting is encoded in bit 4. True is encoded as a 1; False is encoded as a 0.
DIS	Distributing is encoded in bit 5. True is encoded as a 1; False is encoded as a 0.
DEF	Defaulted is encoded in bit 6.
EXP	Defaulted is encoded in bit 7.

Bits 7 and 8 are reserved; these are ignored on receipt and transmitted as zero. However, the received value of these bits is recorded on receipt to accurately reflect the actor's view of the partner's state in outgoing PDUs.

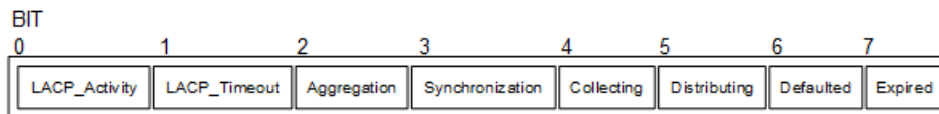
**Figure 5-45: Diagram of state machine octet**

a. `show static-channel-group`

Use this command to display the types of load-balancing port selection criteria (PSC) used on configured static aggregators.

### Command Syntax

```
show static-channel-group (<1-16383>|)
```

### Parameters

<1-16383> Specify channel-group number.

### Command Mode

Privileged Exec mode

### Applicability

This command was introduced before OcNOS version 1.3.

### Examples

The following is an example of the output of this command:

```
#show static-channel-group 1
% Static Aggregator: sa1
% Member:
  eth1
```



---

## show static-channel load-balance

Use this command to display information about static channel groups.

### Command Syntax

```
show static-channel (<1-16383>|) load-balance
```

### Parameters

<1-16383>            Specify static-channel-group number.

### Command Mode

Privileged Exec mode

### Applicability

This command was introduced before OcNOS version 1.3.

### Examples

The following is an example of the output of this command:

```
#show static-channel load-balance
% Static Aggregator: sa5
Source and Destination Mac address
-----
% Static Aggregator: sa3
Source and Destination Mac address
-----
% Static Aggregator: sa1
Source and Destination Mac address

#show static-channel 1 load-balance
% Static Aggregator: sa1
Source and Destination Mac address
```

---

## snmp restart lacp

Use this command to restart SNMP in LACP.

### Command Syntax

```
snmp restart lacp
```

### Parameters

None

### Default

By default, snmp restart lacp is disabled

### Command Mode

Configure mode

### Applicability

This command was introduced before OcNOS version 1.3.

### Examples

```
(config)#snmp restart lacp
```

---

## static-channel-group

Use this command to create a static link aggregation group or to add an interface to an existing link aggregation group.

Use the `no` form of this command to remove an interface from a static link aggregation group without removing the static link aggregation group itself.

### Command Syntax

```
static-channel-group <1-16383>
no static-channel-group
```

### Parameter

<1-16383>            Channel group number.

### Default

By default, static channel group is disabled

### Command Mode

Interface mode

### Applicability

This command was introduced before OcNOS version 1.3.

### Example

```
#configure terminal
(config)#interface xe1
(config-if)#switchport
(config-if)#static-channel-group 1
(config-if)#exit

#sh run in sa1
!
interface sa1
  switchport
  port-channel load-balance src-dst-mac
```

This is an example of `no static-channel-group`:

```
#configure terminal
(config)#interface xe1
(config-if)#switchport
(config-if)#no static-channel-group
(config-if)#exit

#sh run in xe1
!
interface xe1
!
#sh run in sa1
!
interface sa1
  switchport
```

```
port-channel load-balance src-dst-mac  
!
```

## CHAPTER 6 Multi-Chassis Link Aggregation Commands

---

This chapter describes the Multi-Chassis Link Aggregation commands.

Multi-Chassis Link Aggregation is also called MLAG, or Distributed Resilient Network Interconnect (DRNI). In this document, it is called MLAG.

- [clear mcec statistics](#)
- [debug mcec](#)
- [domain-address](#)
- [domain hello timeout](#)
- [domain priority](#)
- [domain-system-number](#)
- [idl-higig](#)
- [intra-domain-peer](#)
- [mcec domain configuration](#)
- [mlag](#)
- [mode](#)
- [show mcec statistics](#)
- [show mlag detail](#)
- [show mlag domain](#)
- [show mlag stp-synchronization status](#)
- [show spanning-tree mlag operational-config](#)
- [show spanning-tree mlag sync-detail](#)
- [switchover type](#)

---

## clear mcec statistics

Use this command to clear the statistics related to hello and information PDUs in the MCEC domain.

### Command Syntax

```
clear mcec statistics
```

### Parameters

None

### Command Mode

Privileged exec mode

### Applicability

This command was introduced in OcNOS version 1.3.6.

### Examples

```
#clear mcec statistics
```

## debug mcec

Use this command to view debugging logs for MLAG.

Use the `no` form of this command to remove debugging logs for MLAG.

### Command Syntax

```
debug mcec (timer|event|hello|info|cli|mac-sync|all)
no debug mcec (timer|event|hello|info|cli|mac-sync|all)
```

### Parameters

<code>all</code>	ALL
<code>cli</code>	CLI
<code>event</code>	Event
<code>hello</code>	Hello
<code>info</code>	Info
<code>mac-sync</code>	Mac Sync
<code>timer</code>	Timer

### Command Mode

Privileged Exec mode

### Applicability

This command was introduced before OcnOS version 1.3.

### Example

```
#debug mcec all
#no debug mcec all
```

---

## domain-address

Use this command to configure domain address, which helps to identify the mcec domain.

Use the `no` form of this command to remove the domain address.

### Command Syntax

```
domain-address <domain-id>
no domain-address
```

### Parameters

`domain-id` domain address in HHHH.HHHH.HHHH format

### Command Mode

MCEC mode

### Applicability

This command was introduced before OcNOS version 1.3.

### Examples

```
#config terminal
(config)#mcec domain configuration
(config-mcec-domain)#domain-address 1111.2222.3333
```



---

## domain hello timeout

Use this command to specify the domain hello-timeout value.

### Command Syntax

```
domain-hello-timeout (long|short)
```

### Parameters

long	Long Timeout
short	Short Timeout

### Command Mode

MCEC mode

### Applicability

This command was introduced before OcNOS version 1.3.

### Examples

```
#config terminal
(config)#mcec domain configuration
(config-mcec-domain)#domain-hello-timeout long
```

---

## domain priority

Use this command to specify the priority value associated with mcec domain.

Use the `no` form of this command to remove the priority value associated with mcec domain.

### Command Syntax

```
domain-priority <1-65535>
no domain-priority
```

### Parameters

<1-65535>	Priority Value
-----------	----------------

### Default

The default value is 32768.

### Command Mode

MCEC mode

### Applicability

This command was introduced before OcNOS version 1.3.

### Example

```
#config terminal
(config)#mcec domain configuration
(config-mcec-domain)#domain-priority 2
```

---

## domain-system-number

Use this command to configure domain system number, which uniquely identifies domain system in mcec domain.

Use the `no` form of this command to configure domain system number.

### Command Syntax

```
domain-system-number <1-2>
no domain-system-number
```

### Parameters

<1-2>	Domain System Number
-------	----------------------

### Command Mode

MCEC mode

### Applicability

This command was introduced before OcnOS version 1.3.

### Example

```
#config terminal
(config)#mcec domain configuration
(config-mcec-domain)#domain-system-number 2
```

---

## idl-higig

Use this command to configure MLAG IDL to Higig mode. The Higig mode is required for MLAG port isolation to work when the MLAG link fails.

Use no form command to unconfigure the idl higig mode

### Command Syntax

```
idl-higig
no idl-higig
```

### Parameters

None

### Command Mode

MCEC mode

### Applicability

This command was introduced before OcNOS Version 6.0.

### Example

```
#config terminal
(config)#mcec domain configuration
(config-mcec-domain)#idl-higig
(config-mcec-domain)#no idl-higig
```

---

## intra-domain-peer

Use this command to map an interface as intra domain peer that connects the domain system with its neighbor in a mcec domain.

Use the `no` form of this command to unmap the interface configured as intra domain peer that connects the domain system with its neighbor in a mcec domain.

### Command Syntax

```
intra-domain-peer A.B.C.D source-address A.B.C.D (vrf VRF_NAME|)
no intra-domain-peer
```

### Parameters

Peer Address	Peer/Target IPv4 address
A.B.C.D	IPv4 address.
Source Address	Source IPv4 address
A.B.C.D	IPv4 address.
vrf-IFNAME	VRF Interface name

### Command Mode

MCEC mode

### Applicability

This command was introduced before OcNOS-SP version 3.0.

### Example

```
#config terminal
(config)#mcec domain configuration
(config-mcec-domain)#intra-domain-peer 1.1.1.1 source-address 2.2.2.2 vrf
myvrf
```

---

## mcec domain configuration

Use this command to enter MCEC Domain configuration mode to configure mcec domain information.

### Command Syntax

```
mcec domain configuration
```

### Parameters

None

### Command Mode

Configure mode

### Applicability

This command was introduced before OcNOS version 1.3.

### Examples

```
#config terminal  
(config)#mcec domain configuration  
(config-mcec-domain)#
```

## mlag

Use this command to map a port-channel to an MLAG instance.

Note: The MLAG port-channel (interface) must be created before mapping.

Note: All MLAG nodes must use the same MAC table size.

Use the `no` form of this command to un-map the port channel from the MLAG instance.

### Command Syntax

```
mlag <1-255>
no mlag
```

### Parameters

<1-255>                    MLAG identifier

### Command Mode

Interface mode

### Applicability

This command was introduced before OcNOS version 1.3 and updated for static channel groups in OcNOS version 1.3.6.

### Example

```
#config terminal
(config)#interface mlag1
(config-if)#switchport
(config-if)#bridge-group 1
(config-if)#switchport mode trunk
(config-if)#switchport mode trunk allowed vlan all
(config-if)#exit
(config)#interface sa1
(config-if)#switchport
(config-if)#mlag 1
(config-if)#exit

#configure terminal
(config)#interface sa1
(config-if)#no mlag
```

---

## mode

Use this command to set the MLAG mode.

Use the no form of this command to turn off this feature.

### Command Syntax

```
mode (active-active | active-standby)
no mode (active-active | active-standby)
```

### Parameters

`active-active` The interface is the active interface that carries the traffic

`active-standby` The interface is ready to transition to the active state should a failure occur in the other node

### Default

`active-active`

### Command Mode

Interface mode

### Applicability

This command was introduced before OcNOS version 1.3.

### Examples

```
(config)#
(config)#interface mlag1
(config-if)#mode active-active
```

```
(config)#
(config)#interface mlag1
(config-if)#mode active-standby
```



## show mcec statistics

Use this command to display all the statistics related to hello and info pdu's in mcec domain.

### Command Syntax

```
show mcec statistics
```

### Parameters

None

### Command Mode

Privileged Exec mode

### Applicability

This command was introduced before OcNOS version 1.3.

### Examples

```
#sh mcec statistics
Unknown MCCPDU received on the system : 0

-----
IDP xe49
-----
Valid RX Hello PDUs : 109
Valid TX Hello PDUs : 201
Valid RX Info PDUs: 23
Valid TX Info PDUs : 28
Valid RX Mac Sync PDUs : 5
Valid TX Mac Sync PDUs : 4
Valid RX Dhcps Sync PDUs : 2
Valid TX Dhcps Sync PDUs : 1

MLAG 1
Valid RX Info PDUs : 5
Valid TX Info PDUs : 7
```

[Table 6-15](#) Shows the output details.

**Table 6-14: Show mcec statistics details**

Entry	Description
RX Hello PDUs	Total number of received hello PDUs.
TX Hello PDUs	Total number of transmitted hello PDUs.
RX Info PDUs	Total number of received Info PDUs.
TX Info PDUs	Total number of transmitted Info PDUs.

**Table 6-14: Show mcec statistics details**

Entry	Description
RX Mac Sync PDUs	Total number of received Mac Sync PDUs.
TX Mac Sync PDUs	Total number of transmitted Mac Sync PDUs.
RX Dhcps Sync PDUs	Total number of received Dhcps Sync PDUs
TX Dhcps Sync PDUs	Total number of transmitted Dhcps Sync PDUs

## show mlag detail

Use this command to display details about MLAG configuration and status.

### Command Syntax

```
show mlag <1-255> detail
```

### Parameters

<1-255> MLAG group number

### Command Mode

Privileged Exec mode

### Applicability

This command was introduced before OcNOS version 1.3 and updated for static channel groups in OcNOS version 1.3.6.

### Examples

```
#sh mlag 1 detail

MLAG-17
Mapped Aggregator : po1
Admin Key : 32769
Oper Key: 16385
Physical properties Digest : dd 9c f 76 dd b6 5f 2f eb a1 d3 bb 8d 96 fc 82

Neigh Admin Key: 16385
Neigh Physical Digest: dd 9c f 76 dd b6 5f 2f eb a1 d3 bb 8d 96 fc 82
Info RCV State : Current
Info Periodic Time State : Standby
Mlag Sync : IN_SYNC
Mode : Active
```

Table 6-15 Shows the output details.

**Table 6-15: Show mlag output details**

Entry	Description
Mapped Aggregator	Map the output of the aggregator in the interface which is active transformation.
Admin Key	Administrative key: automatically configured value on each port configured to use MLAG.
Oper Key	MLAG operator key on partner: automatically configured value on each port configured to use MLAG.
Physical properties Digest	Physical properties of the digest.
Neigh Admin Key	Neigh administrative key: automatically configured value on each port configured to use MLAG.

**Table 6-15: Show mlag output details**

Entry	Description
Neigh Physical Digest	Neighbor physical properties of the digest.
Info RCV State	Details of the RCV.
Info Periodic Time State	A simple state space formulation of a general digital periodic time series.
Mlag Sync	MAC address synchronization: enables a MLAG partner to forward Layer 3 packets arriving on this interfaces with either its own MAC address or its partner's.

---

## show mlag domain

Use this command to display MLAG configuration and status.

### Command Syntax

```
show mlag domain (summary|details)
```

### Parameters

summary	Summary
details	Details

### Command Mode

Privileged Exec mode

### Applicability

This command was introduced before OcNOS version 1.3 and updated for static channel groups in OcNOS version 1.3.6.

### Examples

```
#show mlag domain summary
```

```
-----
Domain Configuration
-----

Domain System Number      : 1
Domain Address            : 1111.2222.3333
Domain Priority           : 32768
Intra Domain Interface    : sa5
Domain Adjacency         : UP

-----
MLAG Configuration
-----

MLAG-1
  Mapped Aggregator       : sa1
  Physical properties Digest : d a6 26 2d fa 9a 5c 7b e6 15 79 c2 d5 9c 57
cc
  Total Bandwidth         : 40g
  Mlag Sync               : IN_SYNC
  Mode                    : Active

MLAG-2
  Mapped Aggregator       : sa2
  Physical properties Digest : ae 56 a1 c5 b9 dc 46 a4 5d 97 dc 79 9c 6f a5
c8

  Total Bandwidth         : 40g
  Mlag Sync               : IN_SYNC
  Mode                    : Active
```

```
# show mlag domain details
-----
Domain Configuration
-----
Domain System Number      : 1
Domain Address            : 1111.2222.3333
Domain Priority           : 32768
Intra Domain Interface    : sa5

Hello RCV State           : Current
Hello Periodic Timer State : Slow Periodic
Domain Sync               : IN_SYNC
Neigh Domain Sync        : IN_SYNC
Domain Adjacency         : UP
-----
MLAG Configuration
-----
MLAG-1
  Mapped Aggregator      : sa1
  Admin Key              : 16385
  Oper Key               : 16385
  Physical properties Digest : d a6 26 2d fa 9a 5c 7b e6 15 79 c2 d5 9c 57
cc

  Neigh Admin Key       : 32769
  Neigh Physical Digest : d a6 26 2d fa 9a 5c 7b e6 15 79 c2 d5 9c 57
cc

  Info RCV State        : Current
  Info Periodic Time State : Standby
  Total Bandwidth       : 40g
  Mlag Sync             : IN_SYNC

MLAG-2
  Mapped Aggregator      : sa2
  Admin Key              : 16386
  Oper Key               : 16386
  Physical properties Digest : ae 56 a1 c5 b9 dc 46 a4 5d 97 dc 79 9c 6f a5
c8

  Neigh Admin Key       : 32770
  Neigh Physical Digest : ae 56 a1 c5 b9 dc 46 a4 5d 97 dc 79 9c 6f a5
c8

  Info RCV State        : Current
  Info Periodic Time State : Standby
  Total Bandwidth       : 40g
  Mlag Sync             : IN_SYNC
```

Table 6-16 Shows the output details.

**Table 6-16: Show mlag summary details**

Entry	Description
Domain System Number	Number to identify the node in domain.
Domain Address	Domain address for the MLAG domain.

**Table 6-16: Show mlag summary details**

<b>Entry</b>	<b>Description</b>
Domain Priority	Domain priority for the MLAG domain.
Intra Domain Interface	Intra domain interface between MLAG domains.
Domain Adjacency	Domain adjacency details and configuration.
Physical properties Digest	physical properties of the digest algorithm.
Total Bandwidth	Total bandwidth available on the interface.
Domain System Number	Number of the domain system.
Domain Address	Domain address for the MLAG domain.
Domain Priority	Domain priority for the MLAG domain.
Intra Domain Interface	Details of the intra domain in the interface.
Hello RCV State	State of the hello RCV in the interface.
Hello Periodic Timer State	State of the hello periodic timer in the interface.
Domain Sync	Detail of the domain configuration synchronization.
Mapped Aggregator	Map the output of the aggregator in the interface which is active transformation.
Admin Key	Administrative key:automatically configured value on each port configured to use MLAG.
Oper Key	MLAG operator key on partner:automatically configured value on each port configured to use MLAG.
Physical properties Digest	Physical properties of the digest.
Neigh Admin Key	Neighbor administrative key: automatically configured value on each port configured to use MLAG.
Neigh Physical Digest	Neighbor physical properties of the digest.
Info RCV State	Details of the RCV.
Info Periodic Time State	A simple state space formulation of a general digital periodic time series.
Mlag Sync	MAC address synchronization: enables a MLAG partner to forward Layer 3 packets arriving on this interfaces with either its own MAC address or its partner's.

---

## show mlag stp-synchronization status

Use this command to display information about MLAG STP Synchronization status

### Command Syntax

```
show mlag stp-synchronization status
```

### Parameters

```
stp-synchronization STP synchronization related show commands
status              STP synchronization status
```

### Command Mode

Exec mode and Privileged Exec mode

### Applicability

This command was introduced before OcNOS version 1.3.

### Examples

```
OcNOS#show mlag stp-synchronization status
```

```
Home STP Domain Digest      : 27 e7 22 79 76 b2 c8 4e 49 9f b4 45 4f 20 68 aa
Neighbor STP Domain Digest  : 27 e7 22 79 76 b2 c8 4e 49 9f b4 45 4f 20 68 aa
STP Sync Status              : IN_SYNC
```

-----

```
MLAG Interface Status:
```

```
MLAG1:
```

```
Home Interface Digest       : 76 88 b9 cd 43 c1 b0 9d b 86 64 e5 b7 d2 7f a7
Neighbor Interface Digest   : 76 88 b9 cd 43 c1 b0 9d b 86 64 e5 b7 d2 7f a7
STP Sync Status             : IN_SYNC
```

```
#
```

Entry	Description
Home STP Domain Digest	STP Domain properties of the digest
Neighbor STP Domain Digest	Neighbor STP Domain properties of the
digest	
STP Sync Status	Detail of configured STP
synchronization.	
Home Interface Digest	Interface properties of the digest.
Neighbor Interface Digest	Neigh Interface properties of the
digest.	



---

## show spanning-tree mlag operational-config

Use this command to display the operational information for MLAG.

### Command Syntax

```
show spanning-tree mlag operational-config
```

### Parameters

None

### Command Mode

Privilege exec mode

### Applicability

This command was introduced in OcNOS version 1.3.6.

### Examples

```
#show spanning-tree mlag operational-config  
Operational Configuration
```

```
-----  
Bridge Priority          : 32768  
Pathcost method        : Long  
  
Interface               : mlag1  
Pathcost                : 1000  
Priority                : 0
```

---

## show spanning-tree mlag sync-detail

Use this command to display the spanning-tree properties shared with the domain peer node.

### Command Syntax

```
show spanning-tree mlag sync-detail
```

### Parameters

None

### Command Mode

Privilege exec mode

### Applicability

This command was introduced in OcNOS version 1.3.6.

### Examples

```
#show spanning-tree mlag sync-detail
```

```
Domain Digest Parameters
```

```
-----  
Max Age           : 20  
BPDU Filter       : Disabled  
BPDU Guard        : Disabled  
Hello time        : 2  
Forward Delay     : 15  
Force Version     : 2  
Err-disable status : Disabled  
Err-disable timeout : 300  
MSTP Enabled      : Enabled  
MSTP Bridge Forward : Disabled
```

```
Interface Digest parameters
```

```
-----  
Port Name           : mlag1  
Admin Root Guard    : Disabled  
Admin Edge port     : Disabled  
Portfast configuration : Disabled  
Restricted TCN      : Disabled  
Admin BPDU filter   : Default  
Admin BPDU guard    : Default
```

---

## switchover type

Use this command to set the MLAG switchover type.

Use the `no` form of this command to turn off switchover.

### Command Syntax

```
switchover type revertive <1-255>
switchover type non-revertive
no switchover type (revertive | non-revertive)
```

### Parameters

<code>revertive</code>	If a failure happens that triggers a switchover, after failure recovery the initially-active node becomes active again
<code>&lt;1-255&gt;</code>	Switch back to the initially-active node this many seconds after failure recovery
<code>non-revertive</code>	Do not switch back to the initially-active node after failure recovery

### Default

<code>revertive</code>	in 10 seconds
------------------------	---------------

### Command Mode

Interface mode

### Applicability

This command was introduced before OcnOS version 1.3.

### Examples

```
(config)#
(config)#interface mlag1
(config-if)#switchover type revertive 20

(config)#
(config)#interface mlag1
(config-if)#switchover type non-revertive
```



---

## CHAPTER 7 VLAN and Private VLAN Commands

---

This chapter has the commands used to manage VLANs and private VLANs.

- `show dtag vlan`
- `show vlan access-map`
- `show vlan`
- `show vlan brief`
- `show vlan classifier`
- `show vlan-reservation`
- `switchport access`
- `switchport hybrid`
- `switchport mode`
- `switchport mode access ingress-filter`
- `switchport mode hybrid acceptable-frame-type`
- `switchport mode hybrid ingress-filter`
- `switchport mode trunk ingress-filter`
- `switchport trunk allowed`
- `switchport trunk allowed vlan dtag`
- `switchport mode (trunk) disable-native-vlan`
- `switchport trunk native`
- `feature vlan classifier`
- `vlan classifier activate`
- `vlan classifier group`
- `vlan classifier rule ipv4`
- `vlan classifier rule mac`
- `vlan classifier rule proto`
- `vlan database`
- `vlan-reservation`
- `vlan VLAN_RANGE bridge`
- `vlan VLAN_RANGE type customer`
- `vlan VLAN_RANGE type service`

## show dtag vlan

Use this command to display information about VLAN double tagging.

### Command Syntax

```
show dtag vlan DTAG_VLAN_ID
```

### Parameters

`DTAG-VLAN-IDS` Outer-VLAN identifier and inner-VLAN identifier in the format 100.200, where 100 is the outer tag and 200 is the inner tag

### Command Mode

Exec mode and Privileged Exec mode

### Applicability

This command was introduced before OcnOS version 1.3.

### Example

```
#show dtag vlan 2000.3001
```

[Table 7-17](#) explains the output.

**Table 7-17: show dtag vlan output**

Field	Description
Bridge	Bridge number
VLAN ID	VLAN identifier
Name	Double tag-VLAN identifiers
State	VLAN state: ACTIVE, SUSPEND, or INVALID
H/W Status	Hardware status: UP or DOWN
Member ports	Interfaces that are part of the VLAN and whether untagged (u) or tagged (t)

---

## show vlan access-map

Use this command to display information for VLAN access maps.

### Command Syntax

```
show vlan access-map
```

### Parameters

None

### Command Mode

Exec mode and Privileged Exec mode

### Applicability

This command was introduced before OcNOS version 1.3.

### Example

```
#show vlan access-map
Vlan access-map myMap 10
    match ip: myMap
    action: drop
```

## show vlan

Use this command to display information about static, dynamic or all VLANs.

### Command Syntax

```
show vlan (all|static|dynamic|auto) bridge <1-32>
```

### Parameters

<1-32>	Displays the bridge group ID.
all	Displays all VLANs (static and dynamic).
static	Displays static VLANs.
dynamic	Displays dynamic VLANs.
auto	Displays auto configured VLANs.

### Command Mode

Exec mode and Privileged Exec mode

### Applicability

This command was introduced before OcNOS version 1.3.

### Example

```
#sh vlan all bridge 1
Bridge  VLAN ID      Name                State  H/W Status      Member ports
      (u)-Untagged, (t)-Tagged
=====
1       1       default            ACTIVE Up              xe2(u) xe10(u)
1       2       vlan2              ACTIVE Up              xe10(t)
1       10      VLAN0010           ACTIVE Up              xe2(t) xe10(t)
1       20      VLAN0020           ACTIVE Up              xe2(t) xe10(t)
1       30      VLAN0030           ACTIVE Up              xe10(t)
1       40      VLAN0040           ACTIVE Up              xe10(t)
1       50      VLAN0050           ACTIVE Up              xe10(t)
1       60      VLAN0060           ACTIVE Up              xe10(t)
#
```

Table 7-18 Explains the show command output fields.

**Table 7-18: show vlan output fields**

Field	Description
Bridge	Number of bridge in the interface.
VLAN ID	VLAN identifier of the VLAN listed.
Name	Name of the VLAN.
State	Indicates whether the physical link is operational and can pass packets.



---

<b>Field</b>	<b>Description</b>
H/W Status	Indicates that the hardware is operational.
Member ports	The tagged interfaces to which a VLAN is associated.

## show vlan brief

Use this command to display brief VLAN information for all bridges.

### Command Syntax

```
show vlan (brief | <2-4094>)
```

### Parameters

None

### Command Mode

Exec mode and Privileged Exec mode

### Applicability

This command was introduced before OcnOS version 1.3.

### Example

The following is a sample output from this command when using the `all` parameter.

```
#show vlan brief
```

```
Bridge          VLAN ID  Name          State  Member ports
=====
1              1      default      ACTIVE eth2 (u)
              (u)-Untagged, (t)-Tagged
0              1      default      ACTIVE
0              2      new          ACTIVE
```

[Table 7-19](#) Explains the show command output fields.

**Table 7-19: show vlan brief output fields**

Field	Description
Bridge	Number of bridge in the interface.
VLAN ID	VLAN identifier of the VLAN listed.
Name	Name of the VLAN.
State	Indicates whether the physical link is operational and can pass packets.
H/W Status	Indicates that the hardware is operational.
Member ports	The tagged interfaces to which a VLAN is associated.

---

## show vlan classifier

Use this command to display information on configured VLAN classifier groups, interfaces configured for a VLAN group or all the groups, or all configured VLAN classifier rules.

If either a group ID or rule ID is not specified, all configured VLAN classifier rules are shown. If either a group ID or rule ID is specified, a specific configured VLAN classifier rule is shown.

### Command Syntax

```
show vlan classifier group interface IFNAME
show vlan classifier group (<1-16>|)
show vlan classifier rule(<1-256>|)
```

### Parameters

group	Displays group activated information.
<1-16>	Displays the group ID
interface	Displays interface information.
interface	Displays interface group information.
group	Displays group activated information.
<1-16>	Displays the group ID.
rule	Displays VLAN classifier rule ID.
<1-256>	Displays rule ID information.

### Command Mode

Exec mode and Privileged Exec mode

### Applicability

This command was introduced before OcNOS version 1.3.

### Example

This example displays groups for VLAN classifier groups:

```
#show vlan classifier group 1
vlan classifier group 1 add rule 1
```

This example displays interfaces for all VLAN classifier groups:

```
#show vlan classifier interface group
vlan classifier group 1 interface fe2
vlan classifier group 1 interface fe3
vlan classifier group 2 interface fe5
vlan classifier group 3 interface fe7
```

This example displays interfaces for VLAN classifier group 1:

```
#show vlan classifier interface group 1
vlan classifier group 1 interface fe2
vlan classifier group 1 interface fe3
```

This example displays interfaces for VLAN classifier rule 1:

```
#show vlan classifier rule 1  
vlan classifier rule 1 mac 222.2222.2222 vlan 2
```

---

## show vlan-reservation

Use this command to display reserved vlans that are configured via vlan-reservation configuration on the switch.

### Command Syntax

```
show vlan-reservation
```

### Parameters

None

### Command Mode

Exec mode

### Applicability

This command was introduced before OcNOS-SP version 5.1.

### Example

```
OcNOS#show vlan-reservation
VLAN ID      Status
=====
500          free
501          free
502          free
503          free
504          free
505          free
506          free
507          free
508          free
509          free
510          free
OcNOS#
```

If user enables port breakout on any of the interface

```
OcNOS(config)#interface xe54/1
OcNOS(config-if)#port breakout enable
OcNOS(config-if)#commit
```

Each subsidiary ports 54/2, 54/3, 54/4 will get vlan-id from the vlan-reservation pool and the status of vlan-id changes to "allocated".

```
OcNOS#show vlan-reservation
VLAN ID      Status
=====
500          allocated
501          allocated
502          allocated
503          free
504          free
505          free
```

## VLAN and Private VLAN Commands

---

```
506          free
507          free
508          free
509          free
510          free
OcNOS#
```

Note: From OcNOS-SP version 5.1, it is mandatory to configure vlan-reservation prior to port breakout configuration.

---

## switchport access

Use this command to change the default VLAN on the current interface.

Note: IP Infusion Inc. does not recommend using VLAN identifier 1 because of interoperability issues with other vendors' equipment.

Use the `no` parameter to remove an existing VLAN.

### Command Syntax

```
switchport access vlan <2-4094>
no switchport access vlan
```

### Parameter

<2-4094> Specify the VLAN identifier.

### Default

The switchport access vlan default value is 3968.

### Command Mode

Interface mode

### Applicability

This command was introduced before OcnOS version 1.3.

### Examples

This example shows the steps of a typical VLAN session, creating and destroying a VLAN.

```
#configure terminal
(config)#interface eth0
(config-if)#switchport access vlan 3

(config)#interface eth0
(config-if)#no switchport access vlan
```

## switchport hybrid

Use this command to set the switching characteristics of the interface to hybrid. Both tagged and untagged frames will be classified over hybrid interfaces.

For a VLAN range, specify two VLAN identifiers: the lowest and then the highest separated by a hyphen. For a VLAN list, specify the VLAN identifiers separated by commas. Do not enter spaces between the hyphens or commas.

Use the `no` parameter to turn off allowed hybrid switching.

### Command Syntax

```
switchport hybrid allowed vlan all
switchport hybrid vlan <2-4094>
switchport hybrid allowed vlan none
switchport hybrid allowed vlan except VLAN_ID
switchport hybrid allowed vlan remove VLAN_ID
switchport hybrid allowed vlan add VLAN_ID egress-tagged (enable|disable)
no switchport hybrid
no switchport hybrid vlan
```

### Parameters

<code>all</code>	Allow all VLANs to transmit and receive through the interface.
<code>none</code>	Allow no VLANs to transmit and receive through the interface.
<code>except</code>	Allow all VLANs except these VLANs to transmit and receive through the interface.
<code>VLAN_ID</code>	VLAN identifier(s) <2-4094>. You can specify a single VLAN, a VLAN range, or a VLAN list.
<code>remove</code>	Remove these VLANs from the member set.
<code>VLAN_ID</code>	VLAN identifier(s) <2-4094>. You can specify a single VLAN, a VLAN range, or a VLAN list.
<code>add</code>	Add these VLANs to the member set.
<code>VLAN_ID</code>	VLAN identifier(s) <2-4094>. You can specify a single VLAN, a VLAN range, or a VLAN list.
<code>egress-tagged</code>	Whether to tag outgoing frames.
<code>enable</code>	Enable egress tagging for outgoing frames.
<code>disable</code>	Disable egress tagging for outgoing frames.

### Default

By default, `switchport hybrid` is enabled.

### Command Mode

Interface mode

### Applicability

This command was introduced before OcNOS version 1.3.



**Examples**

The following shows adding a single VLAN to the member set.

```
(config-if)#switchport hybrid allowed vlan add eg  
switchport hybrid allowed vlan add 2 egress-tagged enable
```

The following shows adding a range of VLANs to the member set.

```
(config-if)#switchport hybrid allowed vlan add eg  
switchport hybrid allowed vlan add 2-4 egress-tagged enable
```

---

## switchport mode

Use this command to set the switching characteristics of the Layer 2 interface.

### Command Syntax

```
switchport mode (access|hybrid|trunk|provider-network|customer-edge  
|customer-network|private-vlan)
```

### Parameters

access	Access.
hybrid	Hybrid.
trunk	Trunk.
provider-network	Provider network.
customer-network	Customer network.

### Default

By default, switchport mode hybrid is enabled.

Configuring an interface to operate in trunk mode using the CLI command `switchport mode trunk` will automatically permit VLAN ID 1 on the trunk ports by default.

### Command Mode

Interface mode

### Applicability

This command was introduced before OcnOS version 1.3.

### Example

```
#configure terminal  
(config)#interface eth0  
(config-if)#switchport mode access
```

---

## switchport mode access ingress-filter

Use this command to set the switching characteristics of the interface to access mode, and classify untagged frames only. Received frames are classified based on the VLAN characteristics, then accepted or discarded based on the specified filtering criteria.

### Command Syntax

```
switchport mode access ingress-filter (enable|disable)
```

### Parameters

<code>ingress-filter</code>	Set the ingress filtering for the received frames.
<code>enable</code>	Set the ingress filtering for received frames. Received frames that cannot be classified in the previous step based on the acceptable frame type parameter (access/trunk) are discarded. This is the default value.
<code>disable</code>	Turn off ingress filtering to accept frames that do not meet the classification criteria.

### Default

Received frames that cannot be classified in the previous step based on the acceptable frame type parameter (access/trunk) are discarded.

### Command Mode

Interface mode

### Applicability

This command was introduced before OcnOS version 1.3.

### Example

```
#configure terminal
(config)#interface eth0
(config-if)#switchport mode access ingress-filter enable
```

---

## switchport mode hybrid acceptable-frame-type

Use this command to set the interface acceptable frame types. This processing occurs after VLAN classification.

Use `no` form of this command to unconfigure the interface acceptable frames.

### Command Syntax

```
switchport mode hybrid acceptable-frame-type (all|vlan-tagged)
no switchport hybrid
```

### Parameters

<code>all</code>	Set all frames can be received
<code>vlan-tagged</code>	Accept only classified frames that belong to the port's member set.

### Default

Received frames that cannot be classified in the previous step based on the acceptable frame type parameter (access/trunk) are discarded.

### Command Mode

Interface mode

### Applicability

This command was introduced before OcnOS version 1.3.

### Example

```
#configure terminal
(config)#interface eth0
(config-if)#switchport mode hybrid acceptable-frame-type vlan-tagged
```

---

## switchport mode hybrid ingress-filter

Use this command to set the switching characteristics of the interface as hybrid, and classify both tagged and untagged frames. Received frames are classified based on the VLAN characteristics, then accepted or discarded based on the specified filtering criteria.

### Command Syntax

```
switchport mode hybrid ingress-filter (enable|disable)
```

### Parameters

enable	Set the ingress filtering for received frames. Received frames that cannot be classified in the previous step based on the acceptable frame type parameter (access/trunk) are discarded. This is the default value.
disable	Turn off ingress filtering to accept frames that do not meet the classification criteria.

### Default

Received frames that cannot be classified in the previous step based on the acceptable frame type parameter (access/trunk) are discarded.

### Command Mode

Interface mode

### Applicability

This command was introduced before OcnOS version 1.3.

### Examples

```
#configure terminal
(config)#interface eth0
(config-if)#switchport mode hybrid ingress-filter enable
```

---

## switchport mode trunk ingress-filter

Use this command to set the switching characteristics of the interface as trunk, and specify only tagged frames. Received frames are classified based on the VLAN characteristics, then accepted or discarded based on the specified filtering criteria.

### Command Syntax

```
switchport mode trunk ingress-filter (enable|disable)
```

### Parameters

<code>ingress-filter</code>	Set the ingress filtering for the received frames.
<code>enable</code>	Set the ingress filtering for received frames. Received frames that cannot be classified in the previous step based on the acceptable frame type parameter (access/trunk) are discarded. This is the default value.
<code>disable</code>	Turn off ingress filtering to accept frames that do not meet the classification criteria.

### Default

Received frames that cannot be classified in the previous step based on the acceptable frame type parameter (access/trunk) are discarded.

### Command Mode

Interface mode

### Applicability

This command was introduced before OcNOS version 1.3.

### Examples

```
#configure terminal
(config)#interface eth0
(config-if)#switchport mode trunk ingress-filter enable
```

---

## switchport trunk allowed

Use this command to set the switching characteristics of the interface to trunk.

For a VLAN range, specify two VLAN identifiers: the lowest and then the highest separated by a hyphen. For a VLAN list, specify the VLAN identifiers separated by commas. Do not enter spaces between the hyphens or commas.

Use the `no` parameter to remove all VLAN identifiers configured on this port.

### Command Syntax

```
switchport trunk allowed vlan all
switchport trunk allowed vlan none
switchport trunk allowed vlan add VLAN_ID
switchport trunk allowed vlan except VLAN_ID
switchport trunk allowed vlan remove VLAN_ID
no switchport trunk
```

### Parameters

<code>all</code>	Allow all VLANs to transmit and receive through the interface.
<code>none</code>	Allow no VLANs to transmit and receive through the interface.
<code>add</code>	Add these VLANs to the member set.
<code>VLAN_ID</code>	VLAN identifier(s) <2-4094>. You can specify a single VLAN, a VLAN range, or a VLAN list.
<code>except</code>	All VLANs except these VLANs are part of the member set.
<code>VLAN_ID</code>	VLAN identifier(s) <2-4094>. You can specify a single VLAN, a VLAN range, or a VLAN list.
<code>remove</code>	Remove these VLANs from the member set.
<code>VLAN_ID</code>	VLAN identifier(s) <2-4094>. You can specify a single VLAN, a VLAN range, or a VLAN list.

### Default

Received frames that cannot be classified in the previous step based on the acceptable frame type parameter (access/trunk) are discarded.

### Command Mode

Interface mode

### Applicability

This command was introduced before OcnOS version 1.3.

### Examples

The following shows adding a single VLAN to the port's member set.

```
(config)#interface eth0
(config-if)#switchport trunk allowed vlan add 2
```

The following shows adding a range of VLANs to the port's member set.

```
(config)#interface eth0  
(config-if)#switchport trunk allowed vlan add 2-4
```



---

## switchport trunk allowed vlan dtag

Use this command to maintain a mapping between the double-tagged logical interfaces with the physical interfaces for the purpose of enabling VLAN-translation on the port alone.

An example of when to use this command is in a GPON application, where an S-tag uniquely identifies an OLT channel partition and a C-tag uniquely identifies a subscriber/service on that channel partition.

### Command Syntax

```
switchport trunk allowed vlan add dtag DTAG-VLAN-IDs
switchport trunk allowed vlan remove dtag DTAG-VLAN-IDs
```

### Parameters

add	Add a mapping
remove	Remove a mapping
DTAG-VLAN-IDs	Outer-VLAN identifier and inner-VLAN identifier in the format 100.200, where 100 is the outer tag and 200 is the inner tag

### Default

None

### Command Mode

Interface mode

### Applicability

This command was introduced before OcnOS version 1.3.

### Examples

```
(config)#int mlag1
(config-if)#switchport
(config-if)#bridge-group 1
(config-if)#switchport mode trunk
(config-if)#switchport trunk allowed vlan add 100,2000
(config-if)#switchport trunk allowed vlan add dtag 2000.3001
```

---

## switchport mode (trunk) disable-native-vlan

Use this command to create switchport mode trunk without any default native vlan (i.e. vlan 1).

Use the no form of this command to delete the CLI and add vlan-1 back as default-native-vlan(i.e. vlan 1) as untagged.

### Command Syntax

```
switchport mode (trunk) disable-native-vlan
no switchport mode (trunk) disable-native-vlan
```

### Parameters

switchport	Set the switching characteristics of interface
mode	Set the mode of the Layer-2 interface
trunk	Set the Layer-2 interface as trunk
disable-native-vlan	Disable native VLAN support

### Command Mode

Interface mode

### Applicability

This command is introduced in OcNOS-SP version 5.1.

### Example

```
OcNOS(config)#int xe7
OcNOS(config-if)#switchport mode trunk disable-native-vlan
```

---

## switchport trunk native

Use this command to configure native VLANs for this port. The native VLAN is used for classifying the incoming untagged packets.

Use the `no` parameter to revert the native VLAN to the default VLAN identifier 1.

### Command Syntax

```
switchport trunk native vlan VLAN_ID
no switchport trunk native vlan
```

### Parameter

VLAN_ID	VLAN identifier(s) <1-4094>. You can specify a single VLAN, or a VLAN list. For a VLAN list, specify the VLAN identifiers separated by commas. Do not enter spaces in between the hyphens or commas.
---------	---

### Default

The default is that ingress filtering is off and all frame types are classified and accepted.

### Command Mode

Interface mode

### Applicability

This command was introduced before OcnOS version 1.3.

### Examples

```
#configure terminal
(config)#interface eth0
(config-if)#switchport trunk native vlan 2

(config)#interface eth0
(config-if)#no switchport trunk native vlan
```

---

## feature vlan classifier

Use this command to enable the feature VLAN classifier.

Use `no` form of this command to disable the feature VLAN classifier.

### Command Syntax

```
feature vlan classifier
no feature vlan classifier
```

### Parameters

`classifier`      VLAN Classifier Service

### Default

By default, feature vlan classifier is enable

### Command Mode

Configure mode

### Applicability

This command was introduced before OcnOS version 1.3.

### Example

```
#configure terminal
(config)#feature vlan classifier
(config)#no feature vlan classifier
```

---

## vlan classifier activate

Use this command to activate the VLAN classifier.

Use no form of this command to deactivate the VLAN classifier.

### Command Syntax

```
vlan classifier activate <1-16> vlan <2-4096>
no vlan classifier activate <1-16>
```

### Parameters

<1-16>	Indicates the VLAN classifier activate identifier.
<2-4094>	VLAN identifier of the primary VLAN.

### Default

By default, vlan classifier activate value is 1

### Command Mode

Interface mode

### Applicability

This command was introduced before OcnOS version 1.3.

### Example

```
#configure terminal
(config)#interface eth2
(config-if)#vlan classifier activate 1 vlan 2

(config-if)#no vlan classifier activate 1
```

---

## vlan classifier group

Use this command to create a subnet-based VLAN classifier group. A group indicates a VLAN classifier group ID.

### Command Syntax

```
vlan classifier group <1-16> (add | delete) rule <1-256>
no vlan classifier group <1-16>
```

### Parameters

add	Adds a rule to a group.
delete	Deletes a rule from a group.
rule	Indicates the VLAN classifier rule identifier <1-256>.

### Default

By default, vlan classifier group value is 1

### Command Mode

Configure mode

### Applicability

This command was introduced before OcnOS version 1.3.

### Example

```
#configure terminal
(config)#vlan classifier group 1 delete rule 1
(config)#no vlan classifier group 2
```

---

## vlan classifier rule ipv4

Use this command to create a subnet-based VLAN classifier rule and map it to a specific VLAN. If the source IP address matches the IP subnet specified in the VLAN classifier rule, received packets are mapped to the designated VLAN.

### Command Syntax

```
vlan classifier rule <1-256> ipv4 A.B.C.D/M
no vlan classifier rule <1-256>
```

### Parameters

A.B.C.D/M                      Indicates the IPv4 address classification. Enter the address in A.B.C.D/M format.

### Default

By default, vlan classifier rule is VLAN1

### Command Mode

Configure mode

### Applicability

This command was introduced before OcnOS version 1.3.

### Example

```
#configure terminal
(config)#vlan classifier rule 2 ipv4 20.20.20.2/24
(config)#no vlan classifier rule 2
```

---

## vlan classifier rule mac

Use this command to create a subnet-based VLAN classifier rule and map it to a specific VLAN.

If the source IP address matches the IP subnet specified in the VLAN classifier rule, received packets are mapped to the designated VLAN.

### Command Syntax

```
vlan classifier rule <1-256> mac WORD
no vlan classifier rule <1-256>
```

### Parameters

WORD                      Indicate the Mac address classification. Enter the address in HHHH.HHHH.HHHH format.

### Default

By default, vlan classifier rule value is VLAN1

### Command Mode

Configure mode

### Applicability

This command was introduced before OcNOS version 1.3.

### Example

```
#configure terminal
(config)#vlan classifier rule 2 mac fe80::22e::b5ff:fee8:6/64
(config)#no vlan classifier rule 2
```



---

## vlan classifier rule proto

Use this command to create a subnet-based VLAN classifier rule for a protocol and map it to a specific VLAN. If the source IP address matches the IP subnet specified in the VLAN classifier rule, received packets are mapped to the designated VLAN.

### Command Syntax

```
vlan classifier rule <1-256> proto (ip|ipv6|ipx|x25|arp|rarp|atalkddp|atalkaarp|
  atmmulti|atmtransport|pppdiscovery|pppsession|xeroxpup|xeroxaddrtrans|g8bpqx25|
  ieeepup|ieeeaddrtrans|dec|decnadumpload|decdnareMOTEconsole|decdnarouting|
  declat|decdiagnostics|deccustom|decsyscomm|<0-65535>)
no vlan classifier rule <1-256>
```

### Parameters

<0-65535>	Ethernet decimal
arp	Address Resolution Protocol
atalkaarp	Appletalk AARP
atalkddp	Appletalk DDP
atmmulti	MultiProtocol Over ATM
atmtransport	Frame-based ATM Transport
dec	DEC Assigned
deccustom	DEC Customer use
decdiagnostics	EC Diagnostics
decnadumpload	DEC DNA Dump/Load
decdnareMOTEconsole	DEC DNA Remote Console
decdnarouting	DEC DNA Routing
declat	DEC LAT
decsyscomm	DEC Systems Comms Arch
g8bpqx25	G8BPQ AX.25
ieeeaddrtrans	Xerox IEEE802.3 PUP Address Translation
ieeepup	Xerox IEEE802.3 PUP
ip	IP address
ipv6	IPv6 address
ipx	IPX address
pppdiscovery	PPPoE discovery
pppsession	PPPoE session
rarp	Reverse Address Resolution
x25	CCITT X.25
xeroxaddrtrans	Xerox PUP Address Translation
xeroxpup	Xerox PUP

<code>ethv2</code>	Ethernet v2
<code>nosnapllc</code>	Indicates LLC without snap encapsulation
<code>snapllc</code>	Indicates LLC snap encapsulation

### Default

By default, vlan classifier rule value is VLAN1

### Command Mode

Configure mode

### Applicability

This command was introduced before OcnOS version 1.3.

### Example

```
#configure terminal
(config)#vlan classifier rule 2 proto ip
(config)#no vlan classifier rule 2
```

---

## vlan database

Use this command to enter the VLAN configuration mode to add, delete, or modify values associated with a single VLAN.

### Command Syntax

```
vlan database
```

### Parameters

None

### Default

No default value is specified

### Command Mode

Configure mode

### Applicability

This command was introduced before OcNOS version 1.3.

### Example

In the following example, note the change to VLAN configuration mode from Configure mode:

```
#configure terminal
(config)#vlan database
(config-vlan)#vlan-reservation 500-510
(config-vlan)#no vlan-reservation 500-510
```

---

## vlan-reservation

Use this command to create/delete vlan reservation pool on the switch.

### Command Syntax

```
vlan-reservation VLAN_RANGE  
no vlan-reservation VLAN_RANGE
```

### Parameters

VLAN\_RANGE      VLAN ID 2-4094 or range(s): 2-5,10 or 2-5,7-19

### Default

No default value is specified

### Command Mode

Configure mode

### Applicability

This command was introduced before OcNOS-SP version 5.1.

### Example

In the following example, note the change to VLAN configuration mode from Configure mode:

```
#configure terminal  
(config)#vlan database  
(config-vlan)#
```

---

## vlan VLAN\_RANGE bridge

This command allows you to create a single/range of VLAN's on the VLAN aware bridges.

Use the no form of this command to delete the VLAN.

### Command Syntax

```
vlan VLAN_RANGE bridge <1-32>
vlan <2-4094> bridge <1-32> (state (enable|disable)|)
vlan VLAN_RANGE bridge <1-32> (name WORD|) state (enable | disable)
no vlan VLAN_RANGE bridge <1-32>
```

### Parameters

VLAN_RANGE	The vlan-id or range of vlan-id's separated by ','&'-'
bridge	Specify the bridge group ID in the range <1-32>.
state	Indicates the operational state of the VLAN.
enable	Sets VLAN into an enable state.
disable	Sets VLAN into a disable state.

### Default

By default, vlan bridge state is disabled

### Command Mode

Configuration Mode

VLAN Configuration mode

### Applicability

This command was introduced before OcNOS version 1.3.

### Examples

```
(config)#vlan 3-40,56 bridge 4
(config)#no vlan 2-5 bridge 2
```

## vlan VLAN\_RANGE type customer

This command allows you to create a single/range of VLAN's on the VLAN customer aware.

Use the no form of this command to delete the VLAN.

### Command Syntax

```
vlan VLAN_RANGE (type (customer)|) bridge <1-32> (name WORD|) (state
(disable|enable)|)
no vlan VLAN_RANGE type (customer) bridge <1-32>
no vlan VLAN_RANGE bridge <1-32>
```

### Parameters

VLAN_RANGE	VLAN ID 2-4094 or range(s): 2-5,10 or 2-5,7-19
bridge	Specify the bridge group ID in the range <1-32>.
WORD	The ascii name of the VLAN
state	Indicates the operational state of the VLAN.
enable	Sets VLAN into an enable state.
disable	Sets VLAN into a disable state.
customer	Customer VLAN

### Default

By default, vlan customer state is disabled

### Command Mode

Configuration Mode

VLAN Configuration mode

### Applicability

This command was introduced before OcNOS version 1.3.

### Examples

```
OcNOS(config-vlan)#vlan 15 type customer bridge 1 name abcde state enable
OcNOS(config-vlan)#vlan 2-10,15 type customer bridge 1 state enable
OcNOS(config-vlan)#no vlan 2-10,15 type customer bridge 1
OcNOS(config-vlan)#
OcNOS(config)#no vlan 2-10,15 br 1
OcNOS(config)#end
OcNOS#
```

---

## vlan VLAN\_RANGE type service

This command allows you to create a single/range of VLAN's on the VLAN service.

Use the no form of this command to delete the VLAN.

### Command Syntax

```
vlan VLAN_RANGE type service (point-point|multipoint-multipoint|rooted-multipoint)
  bridge <1-32> (state (disable|enable)|)

vlan VLAN_RANGE type service (point-point|multipoint-multipoint|rooted-multipoint)
  bridge <1-32> name WORD (state (disable|enable)|)

no vlan VLAN_RANGE type service bridge <1-32>
```

### Parameters

VLAN_RANGE	VLAN ID 2-4094 or range(s): 2-5,10 or 2-5,7-19
Service	Service VLAN
Multipoint-multipoint	Service Multipoint to Multipoint Service VLAN
Point-point	Service Point-to-Point Service VLAN
Rooted-multipoint	Service Rooted Multipoint Service VLAN
bridge	Specify the bridge group ID in the range <1-32>.
WORD	The ascii name of the VLAN
State	Operational state of the VLAN
Disable	Disable VLAN status on the bridge
Enable	Enable VLAN status on the bridge

### Default

By default, with the name WORD this can only be given in "vlan database" mode.

### Command Mode

Configuration Mode

VLAN Configuration mode

### Applicability

This command was introduced before OcnOS version 1.3.

### Examples

```
OcnOS(config)#vlan database
OcnOS(config-vlan)#vlan 100 type service multipoint-multipoint bridge 1 name
xxxx state enable
OcnOS(config-vlan)#vlan 101 type service point-point bridge 1 name afsa state
disable
```

```
OcNOS(config-vlan)#vlan 102 type service rooted-multipoint bridge 1 state
enable
OcNOS(config)#vlan 104-107 type service multipoint-multipoint bridge 1 state
enable
OcNOS(config)#vlan 114-117,119 type service multipoint-multipoint bridge 1
state enable
OcNOS(config)#vlan 124-127,129 type service point-point bridge 1 state enable
OcNOS(config)#no vlan 114-117,119 type service br 1
```



---

## CHAPTER 8 802.1x Commands

---

This chapter provides a description, syntax, and examples of the 802.1X commands. It includes the following commands:

- `auth-mac`
- `auth-mac mode`
- `auth-mac dynamic-vlan-creation`
- `auth-mac mac-aging`
- `auth-mac system-auth-ctrl`
- `auth-port`
- `auth-port`
- `dot1x port-control`
- `dot1x protocol-version`
- `dot1x quiet-period`
- `dot1x reauthMax`
- `dot1x reauthentication`
- `dot1x system-auth-ctrl`
- `dot1x timeout re-authperiod`
- `dot1x timeout server-timeout`
- `dot1x timeout supp-timeout`
- `dot1x timeout tx-period`
- `ip radius source-interface`
- `key-string`
- `key-string encrypted`
- `radius-server dot1x host`
- `retransmit`
- `show debugging dot1x`
- `show dot1x`
- `timeout`

---

## auth-mac

Use this command to enable MAC authentication on an interface.

Use the `no` parameter with this command to disable MAC authentication on an interface.

### Command Syntax

```
auth-mac
no auth-mac
```

### Parameters

None

### Default

No default value is specified.

### Command Mode

Interface mode

### Applicability

This command was introduced before OcNOS version 1.3.

### Example

```
#configure terminal
(config)#interface eth0
(config-if)#auth-mac
(config-if)#commit

#configure terminal
(config)#interface eth0
(config-if)#no auth-mac
(config-if)#commit
```

## auth-mac mode

Use this command to enable MAC authentication mode on an interface.

Use the `no` parameter with this command to disable MAC authentication mode on an interface.

### Command Syntax

```
auth-mac mode (filter|shutdown)
no auth-mac mode
```

### Parameters

<code>filter</code>	Filter the frames for the MAC when in an unauthorized state.
<code>shutdown</code>	Shut down the interface when the MAC is unauthenticated.

### Default

No default value is specified.

### Command Mode

Interface mode

### Applicability

This command was introduced before OcnOS version 1.3.

### Example

```
#configure terminal
(config)#interface eth0
(config-if)#auth-mac mode filter
(config-if)#commit

#configure terminal
(config)#interface eth0
(config-if)#no auth-mac mode
(config-if)#commit
```

---

## auth-mac dynamic-vlan-creation

Use this command to enable dynamic VLAN creation after successful MAC authentication. Use the no form of the command to disable dynamic VLAN creation.

### Command Syntax

```
auth-mac dynamic-vlan-creation
no auth-mac dynamic-vlan-creation
```

### Parameters

None.

### Default

Disabled

### Command Mode

Interface mode

### Applicability

This command was introduced before OcNOS version 1.3.

### Examples

```
#configure terminal
(config)#interface eth0
(config-if)#no auth-mac dynamic-vlan-creation

#configure terminal
(config)#interface eth0
(config-if)#auth-mac dynamic-vlan-creation
```

---

## auth-mac mac-aging

Use this command to enable MAC aging. When enabled, a MAC entry is added to the forwarding database, with aging time equal to the bridge aging time. Otherwise, the MAC entry will not be aged out. If MAC aging is disabled, the MAC entry will not be aged out.

Use `no` form of this command to disable MAC aging.

### Command Syntax

```
auth-mac mac-aging
no auth-mac mac-aging
```

### Parameters

None.

### Default

Disabled.

### Command Mode

Interface mode

### Applicability

This command was introduced before OcNOS version 1.3.

### Example

```
#configure terminal
(config)#interface eth0
(config-if)#no auth-mac mac-aging

#configure terminal
(config)#interface eth0
(config-if)#auth-mac mac-aging
```

---

## auth-mac system-auth-ctrl

Use this command to enable MAC authentication globally. If MAC authentication is not enabled, other MAC authentication related commands throw an error when issued.

Use the `no` parameter with this command to disable MAC authentication globally.

### Command Syntax

```
auth-mac system-auth-ctrl
no auth-mac system-auth-ctrl
```

### Parameters

None

### Default

Authentication system messages are not displayed.

### Command Mode

Configure mode

### Applicability

This command was introduced before OcNOS version 1.3.

### Examples

```
#configure terminal
(config)#auth-mac system-auth-ctrl

(config)#no auth-mac system-auth-ctrl
```

---

## auth-port

Use this command to configure a RADIUS server and specify port for RADIUS authentication.

Use the `no` parameter with this command to disable this feature.

### Command Syntax

```
auth-port <1-65535>
no auth-port
```

### Parameters

<0-65535>      Port number.

### Default

The default value of `auth-port` is 1812.

### Command Mode

Configure Radius server mode

### Applicability

This command was introduced before OcnOS Version 6.0.

### Examples

```
#configure terminal
(config)#radius-server dot1x
(config-radius-server)#auth-port 1233
(config-radius-server)#no auth-port 1233
```

## debug dot1x

Use this command to turn on or turn off 802.1x debugging at various levels.

Use the `no` parameter with this command to turn off debugging.

### Command Syntax

```
debug dot1x (all|)
debug dot1x event
debug dot1x nsm
debug dot1x packet
debug dot1x timer
no debug dot1x (all|)
no debug dot1x event
no debug dot1x nsm
no debug dot1x packet
no debug dot1x timer
```

### Parameters

<code>all</code>	Sets debugging for all 802.1x levels.
<code>event</code>	Sets debugging for 802.1x events.
<code>nsm</code>	Sets debugging for 802.1x NSM information.
<code>packet</code>	Sets debugging for 802.1x packets.
<code>timer</code>	Sets debugging for 802.1x timer.

### Default

No default value is specified.

### Command Mode

Exec, Privileged Exec, and Configure modes

### Applicability

This command was introduced before OcNOS version 1.3.

### Examples

```
#configure terminal
(config)#debug dot1x all
(config)#debug dot1x event
```



## dot1x port-control

Use this command to force a port state.

Use the `no` parameter with this command to remove a port from the 802.1x management.

### Command Syntax

```
dot1x port-control (force-unauthorized|force-authorized|auto)
no dot1x port-control
```

### Parameters

<code>auto</code>	Specify to enable authentication on port.
<code>force-authorized</code>	Specify to force a port to always be in an authorized state.
<code>force-unauthorized</code>	Specify to force a port to always be in an unauthorized state.

### Default

The dot1x port-control default is active.

### Command Mode

Interface mode

### Applicability

This command was introduced before OcNOS version 1.3.

### Examples

```
#configure terminal
(config)#interface eth0
(config-if)#dot1x port-control auto

(config)#interface eth0
(config-if)#no dot1x port-control
```

---

## dot1x protocol-version

Use this command to set the protocol version of dot1x to 1 or 2. The protocol version must be synchronized with the Xsupplicant being used in that interface.

Use the `no` parameter with this command to set the protocol version to the default value (2).

### Command Syntax

```
dot1x protocol-version <1-2>
no dot1x protocol-version
```

### Parameters

<1-2>                      Indicates the EAP Over LAN (EAPOL) version.

### Default

The default dot1x protocol version is 2.

### Command Mode

Interface mode

### Applicability

This command was introduced before OcNOS version 1.3.

### Example

```
#configure terminal
(config)#interface eth0
(config-if)#dot1x protocol-version 2

(config)#interface eth0
(config-if)#no dot1x protocol-version
```

---

## dot1x quiet-period

Use this command to set the quiet-period time interval.

When a switch cannot authenticate a client, the switch remains idle for a quiet-period interval of time, then tries again. By administratively changing the quiet-period interval, by entering a lower number than the default, a faster response time can be provided.

Use the `no` parameter with this command to set the configured quiet period to the default (60 seconds).

### Command Syntax

```
dot1x quiet-period <1-65535>
no dot1x quiet-period
```

### Parameter

<1-65535>            Seconds between the retrieval of authentication.

### Default

The default dot1x quiet-period is 60.

### Command Mode

Interface mode

### Applicability

This command was introduced before OcnOS version 1.3.

### Example

```
#configure terminal
(config)#interface eth0
(config-if)#dot1x quiet-period 200
```

---

## dot1x reauthMax

Use this command to set the maximum reauthentication value, which sets the maximum number of reauthentication attempts after which the port will be unauthorized.

Use the `no` parameter with this command to set the reauthentication maximum to the default value (2).

### Command Syntax

```
dot1x reauthMax <1-10>
no dot1x reauthMax
```

### Parameter

<code>&lt;1-10&gt;</code>	Indicates the maximum number of reauthentication attempts after which the port will be unauthorized.
---------------------------	--

### Default

The default is 2.

### Command Mode

Interface mode

### Applicability

This command was introduced before OcNOS version 1.3.

### Examples

The following sets the maximum reauthentication value to 5.

```
#configure terminal
(config)#interface eth0
(config-if)#dot1x reauthMax 5
```

The following sets the reauthentication maximum to the default value.

```
#configure terminal
(config)#interface eth0
(config-if)#no dot1x reauthMax
```

## dot1x reauthentication

Use this command to enable reauthentication on a port.

Use the `no` parameter to disable reauthentication on a port.

### Command Syntax

```
dot1x reauthentication
no dot1x reauthentication
```

### Parameters

None

### Default

The dot1x reauthentication default is disabled.

### Command Mode

Interface mode

### Applicability

This command was introduced before OcNOS version 1.3.

### Examples

```
#configure terminal
(config)#interface eth0
(config-if)#dot1x reauthentication
```

---

## dot1x system-auth-ctrl

Use this command to enable globally authentication.

Use the `no` parameter to disable globally authentication.

### Command Syntax

```
dot1x system-auth-ctrl
no dot1x system-auth-ctrl
```

### Parameters

None

### Default

Authentication is off by default.

### Command Mode

Configure mode

### Applicability

This command was introduced before OcNOS version 1.3.

### Example

```
#configure terminal
(config)#dot1x system-auth-ctrl
```

---

## dot1x timeout re-authperiod

Use this command to set the interval between reauthorization attempts.

Use the `no` parameter to disable the interval between reauthorization attempts.

### Command Syntax

```
dot1x timeout re-authperiod <1-4294967295>  
no dot1x timeout re-authperiod
```

### Parameter

<1-4294967295> Specify the seconds between reauthorization attempts.

### Default

Default time is 3600 seconds

### Command Mode

Interface mode

### Applicability

This command was introduced before OcNOS version 1.3.

### Example

```
#configure terminal  
(config)#interface eth0  
(config-if)#dot1x timeout re-authperiod 25
```

---

## dot1x timeout server-timeout

Use this command to set the authentication sever response timeout.

Use the `no` parameter to disable the authentication sever response timeout.

### Command Syntax

```
dot1x timeout server-timeout <1-65535>
no dot1x timeout server-timeout
```

### Parameter

<1-65535> Specify the authentication server response timeout.

### Default

Default timeout is 30 seconds.

### Command Mode

Interface mode

### Applicability

This command was introduced before OcnOS version 1.3.

### Examples

```
#configure terminal
(config)#interface eth0
(config-if)#dot1x timeout server-timeout 555

(config)#interface eth0
(config-if)#no dot1x timeout server-timeout
```



---

## dot1x timeout supp-timeout

Use this command to set the interval for a supplicant to respond.

Use the `no` parameter to disable the authentication sever response timeout.

### Command Syntax

```
dot1x timeout supp-timeout <1-65535>
no dot1x timeout supp-timeout
```

### Parameter

<1-65535> Specify the authentication server response timeout.

### Default

Default timeout is 30 seconds.

### Command Mode

Interface mode

### Applicability

This command was introduced before OcNOS version 1.3.

### Example

```
#configure terminal
(config)#interface eth0
(config-if)#dot1x timeout supp-timeout 40

(config)#interface eth0
(config-if)#no dot1x timeout supp-timeout
```

## dot1x timeout tx-period

Use this command to set the interval between successive attempts to request an ID.

Use the `no` parameter to disable the interval between successive attempts to request an ID.

### Command Syntax

```
dot1x timeout tx-period <1-65535>
no dot1x timeout tx-period
```

### Parameter

<1-65535> Specify the authentication server response timeout.

### Default

Default timeout is 30 seconds.

### Command Mode

Interface mode

### Applicability

This command was introduced before OcNOS version 1.3.

### Examples

```
#configure terminal
(config)#interface eth0
(config-if)#dot1x timeout tx-period 34

(config)#interface eth0
(config-if)#no dot1x timeout tx-period
```

---

## ip radius source-interface

Use this command to set the local address sent in packets to the radius server.

Use the `no` parameter to clear the local address.

### Command Syntax

```
ip radius source-interface A.B.C.D <1-65535>
no ip radius source-interface
```

### Parameters

A.B.C.D	IPv4 address of the RADIUS server.
<1-65535>	Port number.

### Default

The default port number is 1812.

### Command Mode

Configure mode

### Applicability

This command was introduced before OcnOS version 1.3.

### Examples

```
#configure terminal
(config)#ip radius source-interface myhost 1812

(config)#no ip radius source-interface
```

## key-string

Use this command to define a password in plain-text to be used by a key.

The password is stored as encrypted, and is displayed in encrypted text when show running-config command is executed.

Use the `no` parameter with this command to disable this feature.

### Command Syntax

```
key-string WORD
no key-string
```

### Parameter

WORD	Specify a string of characters to be used as a password by the key. The length of the string should be between 1-64 characters.
------	---

### Default

By default, password is not configured.

### Command Mode

Configure Radius server mode

### Applicability

This command was introduced in OcNOS Version 6.0.

### Examples

```
#configure terminal
(config)#radius-server dot1x host 1.1.1.1
(config-radius-server)#key-string 1234567890
(config-radius-server)#no key-string
```

---

## key-string encrypted

Use this command to define a password in its encrypted format to be used by a key.

Use the `no` parameter with this command to disable this feature.

### Command Syntax

```
key-string encrypted WORD
no key-string
```

### Parameter

`WORD` Specify a string of characters to be used as a password by the key. The length of the string should be between 18-130 characters.

### Default

By default, password is not configured.

### Command Mode

Configure Radius server mode

### Applicability

This command was introduced in OcNOS Version 6.0.

### Examples

```
#configure terminal
(config)#radius-server dot1x host 1.1.1.1
(config-radius-server)#key-string encrypted 0x16176d21cc1688d995
(config-radius-server)#no key-string
```

---

## radius-server dot1x host

Use this command to specify the IP address or host name of the remote radius server host and assign authentication and accounting destination port numbers. Multiple radius-server host commands can be used to specify multiple hosts. The software searches for hosts in the order they are specified.

If no host-specific timeout, retransmit, or key values are specified, the global values apply to that host.

If the auth-port parameter is not specified, the default value of the auth-port is used. If the auth-port is not specified to unconfigure, and the default value of the auth-port does not match with the port you are trying to unconfigure, then the specified radius-server host will not be unconfigured.

Use the `no` form of the command to unconfigure a specified radius-server.

### Command Syntax

```
radius-server dot1x host (A.B.C.D)
no radius-server dot1x host (A.B.C.D)
```

### Parameters

<code>dot1x</code>	IEEE 802.1X Port-Based Access Control.
<code>A.B.C.D</code>	IPv4 address of the RADIUS server.

### Default

The default value of auth-port is 1812.

### Command Mode

Configure mode

### Applicability

This command was introduced before OcnOS version 1.3.

### Examples

```
#configure terminal
(config)#radius-server dot1x host 1.1.1.1
(config-radius-server)#
(config)#no radius-server dot1x host 1.1.1.1
```

---

## retransmit

Use this command to specify the number of times the router transmits each radius request to the server before giving up.

Use the `no` form of this command to disable retransmission.

### Command Syntax

```
retransmit <0-100>
no retransmit
```

### Parameter

<0-100> Specify the retransmit value. Enter a value in the range 0 to 100. If no retransmit value is specified, the global value is used.

### Default

The default value is 3.

### Command Mode

Configure mode

### Applicability

This command was introduced before OcnOS version 1.3.

### Examples

```
#configure terminal
(config)#radius-server dot1x host 1.1.1.1
(config-radius-server)#retransmit 12
(config-radius-server)#no retransmit
```

---

## show debugging dot1x

Use this command to display the status of the debugging of the 802.1x system.

### Command Syntax

```
show debugging dot1x
```

### Parameters

None

### Command Mode

Privileged Exec mode

### Applicability

This command was introduced in OcNOS Version 6.0.

### Example

```
#show debugging dot1x  
802.1X debugging status:
```



---

## show dot1x

Use this command to display IEEE 802.1x port-based access control information.

### Command Syntax

```
show dot1x
show dot1x all
show dot1x host
show dot1x diagnostics interface IFNAME
show dot1x interface IFNAME
show dot1x sessionstatistics interface IFNAME
show dot1x statistics interface IFNAME
```

### Parameters

all	Display all IEEE 802.1x port-based access control information.
host	Show operational radius-server dot1x host information for a specific host (IPv4 address) or for all hosts.
diagnostics	Display diagnostics information.
IFNAME	Interface name.
sessionstatistics	Display the statistics for a session.
statistics	Display the statistics.

### Command Mode

Exec mode and Privileged Exec mode

### Applicability

This command was introduced before OcNOS version 1.3.

### Example

The following is an output of this command displaying the state of the system.

```
#show dot1x
% 802.1x authentication enabled
% Radius server address: 192.168.1.1.1812
% Radius client address: dhcp128.mySite.com.12103
% Next radius message id: 0
```

The following is an output of this command displaying detailed information for all ports.

```
#show dot1x all
% 802.1x authentication enabled
% Radius server address: 192.168.1.1.1812
% Radius client address: dhcp128.mySite.com.12103
% Next radius message id: 0
% Dot1x info for interface eth1 - 3
% portEnabled: true - portControl: auto
% portStatus: unauthorized - currentId: 11
```

```

% reAuthenticate: disabled
% abort:F fail:F start:F timeout:F success:F
% PAE: state: connecting - portMode: auto
% PAE: reAuthCount: 2 - rxRespId: 0
% PAE: quietPeriod: 60 - reauthMax: 2 - txPeriod: 30
% BE: state: idle - reqCount: 0 - idFromServer: 0
% BE: suppTimeout: 30 - serverTimeout: 30 - maxReq: 2
% CD: adminControlledDirections: in - operControlledDirections: in
% CD: bridgeDetected: false
% KR: rxKey: false
% KT: keyAvailable: false - keyTxEnabled: false

```

The following tables describes the output of the `show dot1x` command.

**Table 8-20: Port variables**

Entry	Description
portEnabled	Interface operational status (Up-true/down-false)
portControl	Current control status of the port for 802.1x control
portStatus	802.1x status of the port (authorized/unauthorized)
reAuthenticate	Reauthentication enabled/disabled status on port
reAuthPeriod	Reauthentication period

**Table 8-21: Supplicant PAE related global variables**

Entry	Description
abort	Abort authentication when true
fail	Failed authentication attempt when false
start	Start authentication when true
timeout	Authentication attempt timed out when true
success	Authentication successful when true

**Table 8-22: 802.1x Operational state of interface**

Entry	Description
mode	Configured 802.1x mode
reAuthCount	Reauthentication count
quietperiod	Time between reauthentication attempts
reAuthMax	Maximum reauthentication attempts

**Table 8-23: Backend authentication state machine variables and constants**

Entry	Description
state	State of the port.
reqCount	Number of requests sent to server
suppTimeout	Number of seconds the port waits for a response when relaying a request from the authentication server to the supplicant before resending the request.
serverTimeout	Number of seconds the port waits for a reply when relaying a response from the supplicant to the authentication server before timing out.
maxReq	Maximum number of times a request packet is retransmitted to the supplicant before the authentication session times out.

**Table 8-24: Controlled directions state machine**

Entry	Description
adminControlledDirections	Administrative value (Both/In)
operControlledDirections	Operational Value (Both/In)

**Table 8-25: KR -- Key receive state machine**

Entry	Description
rxKey	True when EAPOL-Key message is received by supplicant or authenticator. false when key is transmitted

**Table 8-26: Key Transmit state machine**

Entry	Description
keyAvailable	False when key has been transmitted by authenticator, true when new key is available for key exchange
keyTxEnabled	Key transmission enabled/disabled status

## timeout

Use this command to specify the number of seconds a router waits for a reply to a radius request before retransmitting the request.

Use the `no` parameter to use the default value.

### Command Syntax

```
timeout <0-60>
no timeout
```

### Parameter

<0-60>                    RADIUS server timeout period in seconds.

### Default

The default value is 5 seconds.

### Command Mode

Configure Radius server mode

### Applicability

This command was introduced before OcNOS version 1.3.

### Examples

```
#configure terminal
(config)#radius-server dot1x host 1.1.1.1
(config-radius-server)#timeout 20
(config-radius-server)#no timeout
```

## CHAPTER 9 Link Layer Discovery Protocol Commands

---

This chapter describes the Link Layer Discovery Protocol (LLDP) commands.

- [lldp debug](#)
- [lldp ip](#)
- [lldp run](#)
- [lldp tlv](#)
- [lldp tlv-select](#)
- [set lldp chassis-id-tlv](#)
- [set lldp disable](#)
- [set lldp enable](#)
- [set lldp locally-assigned](#)
- [set lldp management-address-tlv](#)
- [set lldp msg-tx-hold](#)
- [set lldp timer](#)
- [set lldp too-many-neighbors](#)
- [show lldp](#)
- [snmp restart lldp](#)

## lldp debug

Use this command to turn on debugging functions for LLDP.

Use the `no` form of this command to turn off LLDP debugging functions

### Command Syntax

```
lldp debug (event|rx|tx|message)
no lldp debug (event|rx|tx|message)
```

### Parameters

<code>event</code>	Event debugging
<code>message</code>	NSM message debugging
<code>rx</code>	RX debugging
<code>tx</code>	TX debugging

### Command Mode

Exec mode and Privileged Exec mode

### Examples

```
#lldp debug event
#lldp debug messages
```

## lldp ip

Use this command to set the Link Layer Discovery Protocol with an IP address to be used as a chassis and management ID.

Use the `no` form of this command to remove this value.

### Command Syntax

```
lldp ip address A.B.C.D
no lldp ip address
```

### Parameters

A.B.C.D            Enter the IP address value

### Command Mode

Configure mode

### Examples

```
#configure terminal
(config)#lldp ip address 1.1.1.1
(config)#no lldp ip address
```

---

## lldp run

Use this command to start the Link Layer Discovery Protocol (LLDP).

Use the `no` form of this command to stop LLDP.

### Command Syntax

```
lldp run
no lldp run
```

### Parameters

None

### Command Mode

Configure mode

### Example

```
#configure terminal
(config)#lldp run

(config)#no lldp run
```



---

## lldp tlv

Use this command to set the TLVs enabled for transmission on a port. Make sure that the complete set of Type Length Values (TLVs) is specified when giving this command, because TLVs not specified are disabled.

### Command Syntax

```
lldp tlv {chassis-id|port-id|ttl|port-description|system-name|system-  
description|system-capabilities|management-address|ieee-8021-org-specific|ieee-  
8023-org-specific}
```

### Parameters

chassis-id	Chassis ID type length values (TLV)
port-id	Port ID TLV
ttl	Time to live TLV
port-description	Port description TLV
system-name	System name TLV
system-description	System Description
system-capabilities	System capabilities TLV
management-address	Management address TLV
ieee-8021-org-specific	IEEE 802.1 organizationally-specific TLV
ieee-8023-org-specific	IEEE 802.3 organizationally-specific TLV

### Command Mode

Interface mode

### Example

```
#configure terminal  
(config)#interface eth0  
(config-if)#lldp tlv chassis-id ieee-8021-org-specific ieee-8023-org-specific  
management-address port-description port-id system-capabilities system-  
description system-name ttl
```

---

## lldp tlv-select

Use this command to configure interface LLDP parameters.

This command can be executed globally for all ports (configure mode) or locally for a specific port (interface mode).

When you give this command globally on all ports:

- The `show running-config` command only displays the options in global mode.
- A global configuration overrides an interface-level configuration. For example, if you disable an option on an interface, it is enabled after enabling the same option globally. If the option was enabled previously, the `show` output is suppressed and only global mode is displayed (to avoid duplicating the same configuration).
- After enabling a global configuration, when a new LLDP agent is configured on a port, it inherits the global TLV configuration. However, `show` output does not appear per interface/agent.
- After enabling globally, if you disable an option on an interface, the "no" form for this command is shown for that interface.
- Enabling an already enabled option causes an error.

If you disable globally on all ports:

- The option is removed globally, as well as overrides configurations for all interfaces.
- If the option was not enabled globally, it causes an error.

When enabled locally on a port:

- If the same option was enabled globally, it causes an error.
- If not already enabled, the option is enabled for the given interface alone.

When disabled locally on a port:

- If the option was not present locally or globally, it causes an error.
- If the option was enabled globally, the option is removed from this interface alone. No command will be displayed in `show` output.

Use the *no* form of this command to remove interface LLDP parameter configurations.

### Command Syntax

```
lldp tlv-select (port-description|system-name| system-description|system-
capabilities|management-address| ieee-8021-org-specific | ieee-8023-org-specific)
no lldp tlv-select (port-description|system-name|system-description|system-
capabilities|management-address|ieee-8021-org-specific | ieee-8023-org-specific)
```

### Parameters

<code>port-description</code>	Port description TLV
<code>system-name</code>	System name TLV
<code>system-description</code>	System Description
<code>system-capabilities</code>	System capabilities TLV
<code>management-address</code>	

**Management address TLV**

ieee-8021-org-specific

**IEEE 802.1 organizationally-specific TLV**

ieee-8023-org-specific

**IEEE 802.3 organizationally-specific TLV****Command Mode**

Configure mode and interface mode

**Example**

```
#configure terminal
(config)#lldp tlv-select system-capabilities

#configure terminal
(config)#interface eth2
(config-if)#lldp-agent
(config-if-lldp-agent)#lldp tlv-select system-capabilities
```

---

## set lldp chassis-id-tlv

Use this command to set the chassis ID subtype for the LLDP agent on a port.

### Command Syntax

```
set lldp chassis-id-tlv (mac-address | ip-address)
```

### Parameters

mac-address	Use the MAC address as the chassis ID
ip-address	Use the management IP address as the chassis ID

### Command Mode

Interface mode

### Examples

```
#configure terminal  
(config)#interface eth0  
(config-if)#set lldp chassis-id-tlv ip-address
```

---

## set lldp disable

Use this command to disable the LLDP agent on a port.

### Command Syntax

```
set lldp disable
```

### Parameters

None

### Command Mode

Interface mode

### Examples

```
#configure terminal  
(config)#interface eth0  
(config-if)#set lldp disable
```

---

## set lldp enable

Use this command to enable an LLDP agent on a port and specify its type.

### Command Syntax

```
set lldp enable (txonly|txrx|rxonly)
```

### Parameters

rxonly	Receive-only
txonly	Transmit-only
txrx	Transmit and receive

### Default

By default, no LLDP agent is enabled for a port.

### Command Mode

Interface mode

### Examples

```
#configure terminal
(config)#interface eth 0
(config-if)#set lldp enable txrx
```

---

## set lldp locally-assigned

Use this command to locally set the LLDP port identifier.

### Command Syntax

```
set lldp locally-assigned NAME
```

### Parameters

NAME	Name of the port.
------	-------------------

### Command Mode

Interface mode

### Examples

```
#configure terminal  
(config)#interface eth0  
(config-if)#set lldp locally-assigned port1
```

---

## set lldp management-address-tlv

Use this command to set the management address subtype for the LLDP agent on a port.

### Command Syntax

```
set lldp management-address-tlv (mac-address | ip-address)
```

### Parameters

mac-address	Use the MAC address as the chassis ID
ip-address	Use the management IP address as the chassis ID

### Command Mode

Interface mode

### Examples

```
#configure terminal
(config)#interface eth0
(config-if)#set lldp management-address-tlv ip-address
```



---

## set lldp msg-tx-hold

Use this command to set the Time To Live (TTL) value for LLDPDUs to be transmitted by the port. The value set with this command is multiplied by the `msg-tx-interval` value (see [set lldp timer](#)), which determines the final TTL value.

### Command Syntax

```
set lldp msg-tx-hold VALUE
```

### Parameters

VALUE	Time in seconds
-------	-----------------

### Default

The default value of the TTL is 4 seconds.

### Command Mode

Interface mode

### Examples

```
#configure terminal
(config)#interface eth0
(config)#set lldp msg-tx-hold 3
```

---

## set lldp timer

Use this command to set the interval at which LLDP frames are transmitted.

### Command Syntax

```
set lldp timer msg-tx-interval <5-32768>
set lldp timer reinitDelay VALUE
set lldp timer tx-delay <1-8192>
```

### Parameters

<5-32768>	Message transmit interval value
VALUE	Reinit delay value
<1-8192>	Transmit delay value in range of: ( $1 \leq \text{tx-delay} \leq ((0.25) * \text{msg-tx-interval})$ )

### Default Values

The default value for `msg-tx-interval` is 30 seconds.

The default value for `reinitDelay` is 2 seconds.

The default value of the `tx-delay` is 2 seconds.

### Command Mode

Interface mode

### Examples

```
#configure terminal
(config)#interface eth0
(config-if)#set lldp timer msg-tx-interval 40

#configure terminal
(config)#interface eth0
(config-if)#set lldp timer reinitDelay 3

#configure terminal
(config)#interface eth0
(config-if)#set lldp timer tx-delay 3
```

---

## set lldp too-many-neighbors

Use this command to set the action to take when the remote table is full.

### Command Syntax

```
set lldp too-many-neighbors limit <1-65535> discard received-info timer <1-65535>
set lldp too-many-neighbors limit <1-65535> discard existing-info MAC
timer <1-65535>
```

### Parameters

limit	The limit on the number of LLDP neighbors.
<1-65535>	The limit on the number of LLDP neighbors.
received-info	The information received for this neighbor.
timer	The period after which received information is discarded.
<1-65535>	The period in seconds after which received information is discarded.
existing-info	The information for this neighbor.
MAC	Identifies the remote LLDP Agent for which information is discarded.
timer	The period in seconds after which existing information is discarded.
<1-65535>	The period in seconds after which existing information is discarded.

### Default Value

No upper limit is enforced for the number of remote LLDP agents.

### Command Mode

Interface mode

### Examples

```
#configure terminal
(config)#interface eth1
(config-if)#set lldp too-many-neighbors limit 20 disc existing-info 1.1.1.1.1
timer 1

(config)#interface eth1
(config-if)#set lldp too-many-neighbors limit 1 discard received-info timer 1
```

---

## show lldp

Use this command to display LLDP port information.

### Command Syntax

```
show lldp port IFNAME
show lldp port IFNAME statistics
```

### Parameters

IFNAME	Name of the interface
statistics	LLDP port statistics

### Command Mode

Exec mode and Privileged Exec mode

### Example

The following sample output from this command displays detailed information about an LLDP-enabled port.

```
#show lldp port eth0
Remote LLDP
MAC Address: 01:06:29:CF:79:A1
TTL: 60
Network Address: 192.168.1.0
Interface Name: eth1
Interface Locally Assigned String: Port-a
Interface Description: bridge
Interface Number: 2
Port Vlan ID: 1
Protocol ID: 274242030202
AutoNego Support: Supported
AutoNego Capability: 1
Operational MAU Type: 3
Link Aggregation Status: Capable
Link Aggregation Port ID: 0
Max Frame Size: 128
System name:
System Description: bridge
System Capabilities: 4
System Capabilities Enabled: 4
```

The following sample output from this command displays all LLDP statistics for a selected port.

```
#show lldp port eth0 statistics
LLDP Port statistics for eth0
Frames transmitted: 22
Frames Aged out: 0
Frames Discarded: 0
Frames with Error: 0
Frames Received: 5
TLVs discarded: 0
TLVs unrecognized 0
```

---

## snmp restart lldp

Use this command to restart SNMP in Link Layer Discovery Protocol (LLDP)

### Command Syntax

```
snmp restart lldp
```

### Parameters

None

### Command Mode

Configure mode

### Examples

```
#snmp restart lldp
```



---

## CHAPTER 10 Link Layer Discovery Protocol v2 Commands

---

The commands in this chapter support:

- Link Layer Discovery Protocol (LLDP) version 2 as described in IEEE 802.1AB 2009
- LLDP-MED protocol extension as per ANSI/TIA-1057 April 2006.

Note: To enable LLDPv2, LLDP (previous version) should be disabled or vice versa.

- `clear lldp counters`
- `lldp-agent`
- `lldp debug`
- `lldp run`
- `set lldp agt-circuit-id`
- `set lldp enable`
- `set lldp chassis-id-tlv`
- `set lldp chassis locally-assigned`
- `set lldp disable`
- `set lldp locally-assigned`
- `set lldp management-address-tlv`
- `set lldp med-devtype`
- `set lldp msg-tx-hold`
- `set lldp port-id-tlv`
- `set lldp timer`
- `set lldp too-many-neighbors`
- `lldp tlv-select`
- `lldp tlv-select med`
- `lldp tlv-select basic-mgmt`
- `lldp tlv-select ieee-8021-org-specific`
- `lldp tlv-select ieee-8023-org-specific`
- `set lldp system-description`
- `set lldp system-name`
- `set lldp tx-fast-init`
- `set lldp tx-max-credit`
- `show debugging lldp`
- `show lldp neighbors`
- `show lldp interface`
- `snmp restart lldp`

---

## clear lldp counters

Use this command to clear the LLDP statistics on all the interfaces.

### Command Syntax

```
clear lldp counters
```

### Parameters

`counters`          Reset the LLDP traffic counters to zero.

### Command Mode

Exec Mode and Privileged Exec mode

### Applicability

This command was introduced before OcnOS version 1.3.

### Examples

```
#clear lldp counters
```



## lldp-agent

Use this command to create an LLDP agent mode.

Note: This command is not supported in SVLAN, VLAN, and loopback interfaces.

Use the `no` parameter to revert to default settings.

### Command Syntax

```
lldp-agent (non-tpmr-bridge |customer-bridge| )
no lldp-agent (non-tpmr-bridge |customer-bridge| )
```

### Parameters

```
non-tpmr-bridge
                    non-tpmr-bridge
customer-bridge
                    customer-bridge
```

### Default

By default LLDP agent is disabled.

### Command Mode

Interface Mode

### Applicability

This command was introduced before OcnOS version 1.3.

### Examples

```
#configure terminal
(config)#interface eth0
(config-if)#lldp-agent customer-bridge

(config-if)#no lldp-agent customer-bridge
(config-if)#exit
```

---

## lldp debug

Use this command to set the debugging functions for LLDP.

Use the no form of this command to turn off LLDP debugging functions

### Command Syntax

```
lldp debug (event|rx|tx|message)
no lldp debug (event|rx|tx|message)
```

### Parameters

event	Enable or disable event debugging
message	Enable or disable NSM message debugging
rx	Enable or disable RX debugging
tx	Enable or disable TX debugging

### Command Mode

Exec mode and Privileged Exec mode

### Applicability

This command was introduced before OcNOS version 1.3.

### Examples

```
#lldp debug event
#lldp debug message
```

## lldp run

Use this command to start the Link Layer Discovery Protocol (LLDP)

Use the no form of this command to stop LLDP

### Command Syntax

```
lldp run
no lldp run
```

### Parameters

None

### Command Mode

Configure mode

### Applicability

This command was introduced before OcnOS version 1.3.

### Example

```
#configure terminal
(config)#lldp run

(config)#no lldp run
```

---

## set lldp agt-circuit-id

Use this command to configure LLDP agt-circuit-id.

### Command Syntax

```
set lldp agt-circuit-id VALUE
```

### Parameters

VALUE Specify LLDP global agt-circuit ID.

### Command Mode

Interface mode

### Applicability

This command was introduced before OcNOS version 1.3.

### Examples

```
(config)#interface eth0
(config-if)#set lldp agt-circuit-id sample
```

## set lldp enable

Use this command to set the admin status of a LLDP agent on a port.

### Command Syntax

```
set lldp enable (txonly|txrx|rxonly)
```

### Parameters

rxonly	Receive-only
txonly	Transmit-only
txrx	Transmit and receive

### Default

By default, no LLDP agent is enabled for a port.

### Command Mode

LLDP Agent mode

### Applicability

This command was introduced before OcnOS version 1.3.

### Examples

```
#configure terminal
(config)#interface eth0
(config-if)#lldp-agent
(lldp-agent)#set lldp enable txrx
(lldp-agent)#exit
```

---

## set lldp chassis-id-tlv

Use this command to set the chassis ID subtype for the LLDP agent on a port.

Use no form of this command to unset the chassis ID subtype.

### Command Syntax

```
set lldp chassis-id-tlv (if-alias | ip-address | mac-address | if-name | locally-
  assigned)
no set lldp chassis-id-tlv
```

### Parameters

mac-address	Use the MAC address as the chassis ID
ip-address	Use the management IP address as the chassis ID
if-alias	Use the IP address as the chassis ID
if-name	Use the interface name as the chassis ID
locally-assigned	Use the locally assigned value as the chassis ID

### Command Mode

LLDP Agent mode

### Applicability

This command was introduced before OcNOS version 1.3.

### Examples

```
#configure terminal
(config)#interface eth0
(config-if)#lldp-agent
(lldp-agent)#set lldp chassis-id-tlv ip-address
(lldp-agent)#no set lldp chassis-id-tlv
```

---

## set lldp chassis locally-assigned

Use this command to set the locally assigned chassis name for the LLDP interface.

### Command Syntax

```
set lldp chassis locally-assigned NAME
```

### Parameters

NAME                      Name assigned to the chassis.

### Command Mode

Configure mode

### Applicability

This command was introduced before OcnOS version 1.3.

### Examples

```
#configure terminal
(config)#set lldp chassis locally-assigned box1
```

---

## set lldp disable

Use this command to disable the admin status of a LLDP agent on a port.

### Command Syntax

```
set lldp disable
```

### Parameters

None

### Command Mode

LLDP Agent mode

### Applicability

This command was introduced before OcNOS version 1.3.

### Examples

```
#configure terminal
(config)#interface eth0
(config-if)#lldp-agent
(lldp-agent)#set lldp disable
(lldp-agent)#exit
```



---

## set lldp locally-assigned

Use this command to set the locally assigned name for LLDP interface.

Use no form of this command to remove the locally assigned name for LLDP interface.

### Command Syntax

```
set lldp locally-assigned NAME
no set lldp locally-assigned NAME
```

### Parameters

NAME                      Name assigned to the port.

### Command Mode

Interface Mode

### Applicability

This command was introduced before OcnOS version 1.3.

### Examples

```
#configure terminal
(config)#interface eth0
(config-if)#lldp-agent
(config-if)#set lldp locally-assigned port1
(config-if)#no set lldp locally-assigned
```

---

## set lldp management-address-tlv

Use this command to set the sub type of the Management Address TLV.

Use `no` form of this command to unset the sub type of the Management Address TLV.

### Command Syntax

```
set lldp management-address-tlv (mac-address | ip-address)
no set lldp management-address-tlv
```

### Parameters

<code>mac-address</code>	Use the MAC address as the Management Address.
<code>ip-address</code>	Use the management IP address as the Management Address.

### Command Mode

LLDP Agent mode

### Applicability

This command was introduced before OcnOS version 1.3.

### Examples

```
#configure terminal
(config)#interface eth0
(config-if)#lldp-agent
(lldp-agent)#set lldp management-address-tlv ip-address
(lldp-agent)#no set lldp management-address-tlv
```

## set lldp med-devtype

Use this command to configure the LLDP device type as Network-Connectivity/ End-Point Class1/ End-Point Class2/ End-Point Class3 device.

Use the `no` parameter to un set the configured LLDP device type.

### Command Syntax

```
set lldp med-devtype (net-connect| ep-class1| ep-class2| ep-class3)
no lldp med-devtype (net-connect| ep-class1| ep-class2| ep-class3)
```

### Parameters

<code>net-connect</code>	Set device type as Network-Connectivity
<code>ep-class1</code>	Set device type as End-Point Class1
<code>ep-class2</code>	Set device type as End-Point Class2
<code>ep-class3</code>	Set device type as End-Point Class3

### Default

None

### Command Mode

Interface mode

### Applicability

This command was introduced before OcnOS version 1.3.

### Examples

```
#configure terminal
(config)#interface eth0
(config-if)#set lldp med-devtype ep-class1
(config-if)#exit
```

```
#configure terminal
(config)#interface eth0
(config-if)#no set lldp med-devtyp
(config-if)#exit
```

---

## set lldp msg-tx-hold

Use this command to set the `msg-tx-hold` parameter that determines the Time To Live (TTL) value for LLDPDUs to be transmitted by the port. The value set with this command is multiplied by the `lldp timer msg-tx-interval` value, which determines the final TTL value.

Use `no` form of this command to set the default value of message transmit hold.

### Command Syntax

```
set lldp msg-tx-hold VALUE
no set lldp msg-tx-hold
```

### Parameters

`VALUE` Specify time in seconds in the range of <1-100> to set message transmit hold.

### Default

The default value of message transmit hold is 4 seconds.

### Command Mode

LLDP Agent mode

### Applicability

This command was introduced before OcnOS version 1.3.

### Examples

```
(config)#interface eth0
(config-if)#lldp-agent
(lldp-agent)#set lldp msg-tx-hold 3
(lldp-agent)#no set lldp msg-tx-hold
```

## set lldp port-id-tlv

Use this command to set the sub type of the Port ID.

Use `no` form of this command to unset the sub type of the Port ID.

### Command Syntax

```
set lldp port-id-tlv (if-alias | ip-address | mac-address | if-name | agt-circuit-
id | locally-assigned)
no set lldp port-id-tlv
```

### Parameters

<code>mac-address</code>	Use the MAC address as the port-id-tlv.
<code>ip-address</code>	Use the management IP address as the port-id-tlv
<code>if-alias</code>	Use the IP alias as the port-id-tlv
<code>if-name</code>	Use the interface name as the port-id-tlv
<code>agt-circuit-id</code>	Use the agt-circuit-id name as the port-id-tlv
<code>locally-assigned</code>	Use the locally assigned value as the port-id-tlv

### Command Mode

LLDP Agent mode

### Applicability

This command was introduced before OcnOS version 1.3.

### Examples

```
(config)#interface eth0
(config-if)#lldp-agent
(lldp-agent)#set lldp port-id-tlv ip-address
(lldp-agent)#no set lldp port-id-tlv
```

## set lldp timer

Use this command to set the interval at which LLDP frames are transmitted.

Use `no` form of this command to set the default value for timer.

### Command Syntax

```
set lldp timer msg-fast-tx <1-3600>
set lldp timer msg-tx-interval <5-3600>
set lldp timer reinit-Delay VALUE
no set lldp timer msg-fast-tx
no set lldp timer msg-tx-interval
no set lldp timer reinit-Delay
```

### Parameters

<code>msg-fast-tx</code>	Set the value in range <1-3600>
<code>msg-tx-interval</code>	Set the value in range <5-3600>
<code>reinitDelay</code>	Set the value in range <1-10>

### Default Values

The default value for `msg-fast-tx` is 1 second.

The default value for `msg-tx-interval` is 30 seconds.

The default value for `reinitDelay` is 2 seconds.

### Command Mode

LLDP Agent mode

### Applicability

This command was introduced before OcNOS version 1.3.

### Examples

```
#configure terminal
(config)#interface eth0
(config-if)#lldp-agent
(lldp-agent)#set lldp timer msg-fast-tx 40
(lldp-agent)#no set lldp timer msg-fast-tx
(lldp-agent)#exit

#configure terminal
(config)#interface eth0
(config-if)#lldp-agent
(lldp-agent)#set lldp timer msg-tx-interval 40
(lldp-agent)#no set lldp timer msg-tx-interval
(lldp-agent)#exit
```

```
#configure terminal
(config)#interface eth0
(config-if)#lldp-agent
(lldp-agent)#set lldp timer reinitDelay 3
(lldp-agent)#no set lldp timer reinitDelay
(lldp-agent)#exit
```

---

## set lldp too-many-neighbors

Use this command to set the action to take when the remote table is full.

Use no form of this command to unset too many neighbors parameters.

### Command Syntax

```
set lldp too-many-neighbors limit <1-65535> discard received-info timer <1-65535>
set lldp too-many-neighbors limit <1-65535> discard existing-info MAC timer <1-65535>
no set lldp too-many-neighbors limit
```

### Parameters

limit	The limit on the number of LLDP neighbors.
<1-65535>	Upper limit for the number of Remote LLDP Information.
received-info	The information received for this neighbor.
timer	The period after which received information is discarded.
<1-65535>	The period in seconds after which received information is discarded.
existing-info	The information for this neighbor.
MAC	Identifies the remote LLDP Agent for which information is discarded.
timer	The period in seconds after which existing information is discarded.
<1-65535>	The period in seconds after which existing information is discarded.

### Default Value

No upper limit is enforced for the number of remote LLDP agents.

### Command Mode

LLDP Agent mode

### Applicability

This command was introduced before OcNOS version 1.3.

### Examples

```
#configure terminal
(config)#interface eth1
(config-if)#lldp-agent
(lldp-agent)#set lldp too-many-neighbors limit 20 disc existing-info
1001.1001.1001 timer 1

(config)#interface eth1
(config-if)#lldp-agent
(lldp-agent)#set lldp too-many-neighbors limit 1 discard received-info timer 1
```



## lldp tlv-select

Use this command to select the set of optional TLV's to be included in the LLDP frames.

Use the `no` parameter to disable the selected set of optional TLV's.

### Command Syntax

```
lldp tlv-select {basic-mgmt| ieee-8021-org-specific| ieee-8023-org-specific}
no lldp tlv-select {basic-mgmt| ieee-8021-org-specific| ieee-8023-org-specific}
```

### Parameters

<code>basic-mgmt</code>	Basic management specific TLV.
<code>ieee-8021-org-specific</code>	IEEE 802.1 organizationally-specific TLV.
<code>ieee-8023-org-specific</code>	IEEE 803.1 organizationally-specific TLV

### Default Value

None

### Command Mode

LLDP Agent mode

### Applicability

This command was introduced before OcnOS version 1.3.

### Examples

```
#configure terminal
(config)#interface eth0
(config-if) lldp-agent
(lldp-agent)#lldp tlv-select basic-mgmt
(lldp-agent)#exit
```

---

## lldp tlv-select med

Use this command to select the set of optional TLV's which can enabled for transmission.

Use the `no` parameter to disable the selected set of optional TLV's.

### Command Syntax

```
lldp tlv-select med (media-capabilities | network-policy| location | extended-  
power-via-mdi | inventory|)
```

```
no lldp tlv-select med (media-capabilities | network-policy| location | extended-  
power-via-mdi | inventory|)
```

### Parameters

<code>network-policy</code>	Select the Network-policy as optional TLV
<code>media-capabilities</code>	Select the Media-capabilities as optional TLV
<code>location</code>	Select the Location as optional TLV
<code>extended-power-via-mdi</code>	Select the extended-power-via-mdi as optional TLV, when PoE feature is available
<code>inventory</code>	Select the Inventory as optional TLV

### Default Value

None

### Command Mode

LLDP Agent mode

### Applicability

This command was introduced before OcNOS version 1.3.

### Examples

```
#configure terminal  
(config)#interface eth0  
(config-if)lldp-agent  
(lldp-agent)#lldp tlv-select network-policy  
(lldp-agent)#exit
```

---

## lldp tlv-select basic-mgmt

Use this command to select the set of basic management TLV's to be included in the LLDP frames.

Use the `no` parameter to disable selected set of basic management TLV's.

### Command Syntax

```
lldp tlv-select basic-mgmt {port-description| system-name| system-description/  
system-capabilities| management-address}  
no lldp tlv-select basic-mgmt {port-description| system-name| system-description/  
system-capabilities| management-address}
```

### Parameters

<code>port-description</code>	Port description specific TLV
<code>system-name</code>	System name specific TLV
<code>system-description</code>	System Description specific TLV
<code>system-capabilities</code>	System capabilities specific TLV
<code>management-address</code>	Management address specific TLV

### Default Value

None

### Command Mode

LLDP Agent mode

### Applicability

This command was introduced before OcnOS version 1.3.

### Examples

```
#configure terminal  
(config)#interface eth0  
(config-if)lldp-agent  
(lldp-agent)#lldp tlv-select basic-mgmt system-name  
(lldp-agent)#exit
```

## lldp tlv-select ieee-8021-org-specific

Use this command to select the set of ieee-8021-org-specific TLV to be included in the LLDP frames.

Use the `no` parameter to disable the selected set of ieee-8021-org-specific TLV.

### Command Syntax

```
lldp tlv-select ieee-8021-org-specific {port-vlanid| port-ptcl-vlanid| vlan-name|
  ptcl-identity| vid-digest| mgmt-vid| link-agg| data-center-bridging|}
no lldp tlv-select ieee-8021-org-specific {port-vlanid| port-ptcl-vlanid| vlan-
  name| ptcl-identity| vid-digest| mgmt-vid| link-agg| data-center-bridging|}
```

### Parameters

<code>mgmt-vid</code>	Select management VLAN identifier TLV
<code>port-ptcl-vlanid</code>	Select port protocol VLAN identifier TLV
<code>port-vlanid</code>	Select port VLAN identifier TLV
<code>ptcl-identity</code>	Select protocol-identifier TLV
<code>vid-digest</code>	Select VLAN identifier digest TLV
<code>vlan-name</code>	Select VLAN name TLV
<code>link-agg</code>	Select link-aggregation TLV
<code>data-center-bridging</code>	Select data-center-bridging TLV

### Default Value

None

### Command Mode

LLDP Agent mode

### Applicability

This command was introduced before OcNOS version 1.3.

### Examples

```
#configure terminal
(config)#interface eth0
(config-if)lldp-agent
(lldp-agent)#lldp tlv-select ieee-8021-org-specific port-vlanid
(lldp-agent)#exit
```

---

## lldp tlv-select ieee-8023-org-specific

Use this command to select the set of ieee-8023-org-specific TLV to be included in the LLDP frames.

Use the `no` parameter to disable the selected ieee-8023-org-specific TLV.

### Command Syntax

```
lldp tlv-select ieee-8023-org-specific {mac-phy| power-via-mdi| max-mtu-size|}
no lldp tlv-select ieee-8023-org-specific {mac-phy| power-via-mdi| max-mtu-size|}
```

### Parameters

<code>mac-phy</code>	VLAN ID Of the provider edge port <2-4094>.
<code>power-via-mdi</code>	Power-via-MDI (only when PoE feature is available)
<code>max-mtu-size</code>	max-mtu-size TLV

### Default Value

None

### Command Mode

LLDP Agent mode

### Applicability

This command was introduced before OcnOS version 1.3.

### Examples

```
#configure terminal
(config)#interface eth0
(config-if)lldp-agent
(lldp-agent)#lldp tlv-select ieee-8023-org-specific mac-phy
(lldp-agent)#exit
```

---

## set lldp system-description

Use this command to identify the string that describes the LLDP system.

Use no form of this command to unset the system description.

### Command Syntax

```
set lldp system-description LINE
unset lldp system-description
```

### Parameters

LINE                      Set the description of the LLDP system.

### Command Mode

Configure mode

### Applicability

This command was introduced before OcNOS version 1.3.

### Example

```
#configure terminal
(config)#set lldp system-description LLDP agent on B1
(config)#unset lldp system-description
```

---

## set lldp system-name

Use this command to identify the system name of the LLDP function.

### Command Syntax

```
set lldp system-name NAME
unset lldp system-name
```

### Parameters

NAME	Name of the LLDP system.
------	--------------------------

### Command Mode

Configure mode

### Applicability

This command was introduced before OcnOS version 1.3.

### Example

```
#configure terminal
(config)#set lldp system-name LLDP1
(config)#unset lldp system-name
```

---

## set lldp tx-fast-init

Use this command to determine the maximum value of LLDP frames that are transmitted during a fast transmission period.

Use `no` form of this command to set fast transmission period to default value.

### Command Syntax

```
set lldp tx-fast-init <1-8>
no set lldp tx-fast-init
```

### Parameters

`tx-fast-init` Set the message transmit interval value <1-8>.

### Default Value

Default value is 4.

### Command Mode

LLDP Agent mode

### Applicability

This command was introduced before OcNOS version 1.3.

### Examples

```
#configure terminal
(config)#interface eth0
(config-if)#lldp-agent
(lldp-agent)#set lldp tx-fast-init 4
(lldp-agent)#no set lldp tx-fast-init
(lldp-agent)#exit
```



---

## set lldp tx-max-credit

Use this command to set the maximum value of transmission credit, which signifies the number of consecutive LLDP frames transmitted.

Use `no` form of this command to set the maximum value of transmission credit to default value.

### Command Syntax

```
set lldp tx-max-credit <1-10>
no set lldp tx-max-credit
```

### Parameters

`tx-max-credit` The maximum value of transmission credit.

### Default Value

Default value is 5

### Command Mode

LLDP Agent mode

### Applicability

This command was introduced before OcnOS version 1.3.

### Examples

```
#configure terminal
(config)#interface eth0
(config-if)lldp-agent
(lldp-agent)#set lldp tx-max-credit <1-10>
(lldp-agent)#no set lldp tx-max-credit
(lldp-agent)#exit
```

---

## show debugging lldp

Use this command to display LLDP debugging information.

### Command Syntax

```
show debugging lldp
```

### Parameters

None

### Command Mode

Exec mode and Privileged Exec mode

### Applicability

This command was introduced before OcNOS version 1.3.

### Example

The following sample output displays information about an LLDP debugging.

```
#show debugging lldp
LLDP debugging status:
  LLDP message debugging is on
```

---

## show lldp neighbors

Use this command to display LLDP neighbors information.

### Command Syntax

```
show lldp (nearest-bridge| non-tpmr-bridge| customer-bridge|) neighbors
(brief|details)
```

### Parameters

nearest-bridge	Display LLDP nearest bridge information
non-tpmr-bridge	Display LLDP non-TPMR-bridge information
customer-bridge	Display LLDP customer-bridge information
neighbor	Neighbor
brief	Brief
details	Details

### Command Mode

Exec mode and Privileged Exec mode

### Applicability

This command was introduced before OcNOS version 1.3 and changed in OcNOS version 1.3.1.

### Example

The following sample output displays information about an LLDP neighbors

```
#sh lldp nearest-bridgr neighbors brief
```

```
Loc PortID  Rem Host Name  Rem Chassis Id  Rem Port Id  Agent Mode
```

```
-----
xe3/1      OcNOS          ecf4.bbfe.2864  ecf4.bbb2.4c65 Nearest bridge
```

```
#show lldp neighbors detail
```

```
-----
-----
Nearest bridge Neighbors
```

```
Interface Name      : ge4
```

```
Mandatory TLVs
```

```
Chassis id type     : MAC address [0c48.c6e1.e160]
```

```
Port id type        : MAC address [0c48.c660.8165]
```

```
Time to live        : 121
```

```
Basic Management TLVs
```

```
System Name         : R-7015
```

```
System Description  : Hardware Model:CEL_BELGITE_E1070, Software versio
```

```
n: OcNOS,6.3.2.47
```

```

Port Description           : ge4
Remote System Capabilities : Bridge
                           Router
  Capabilities Enabled    : Router
Management Address       : MAC Address [0c48.c660.8165]
  Interface Number subtype : ifindex
    Interface Number      : 10004
    OID Number            : 0
802.1 Org specific TLVs
  Port vlan id           : 0
  Port & Protocol vlan id : 0
  Remote Configured VLANs : None
  Remote Protocols Advertised: None
  Remote VID Usage Digest : 0
  Remote Management Vlan : 0
  Link Aggregation Capability: not capable of being aggregated
  Link Aggregation Status : not currently in aggregation
  Link Aggregation Port ID :
802.3 Org specific TLVs
  AutoNego Support       : Not-Supported
  AutoNego Status        : Disabled
  AutoNego Capability    : 0
  Operational MAU Type   : 0 [unknown]
  Max Frame Size         :

```

#

Table 10-28 Shows the output details.

**Table 10-27: show lldp neighbor output details**

Entry	Description
Loc Port ID	Local interface SNMP index (appears when the interface option is used).
Rem Host Name	Name of the remote host.
Rem Chassis Id	Remote chassis identifier of the chassis type listed.
Rem Port Id	Remote port identifier of the port type listed.
Agent Mode	Agent mode enabled to the nearest bridge.
Time to live	Number of seconds for which this information is valid.
Interface Name	Name of the interface.
Chassis id type	Chassis identifier of the chassis type listed.
Port id type	Type of port identifier supplied, such as Locally assigned.
System Name	Name supplied by the system on the interface.
System Description	Description supplied by the system on the interface.

**Table 10-27: show lldp neighbor output details**

<b>Entry</b>	<b>Description</b>
Port Description	The port description field uses the configured port description, the port name or the SNMP if Index (appears when the interface option is used).
Remote System Capabilities	Remote system capabilities (such as Bridge, Bridge Router, and Bridge Telephone) that are supported.
Capabilities Enabled	Enabled by the system on the interface (appears when the interface option is used).
Management Address	Details of management address (such as 10.204.35.34).
Interface Number subtype	Interfaces subtype for which neighbor information is available.
Interface Number	Interfaces for which neighbor information is available.
OID Number	Number of identifier.
Port VLAN ID	Details of the port VLAN identifier.
Protocol VLAN ID	Details of the protocol VLAN identifier.
Remote Configured VLANs	Details of the remote configured VLAN.
Remote Protocols Advertised	Details of the remote protocols.
Remote VID usage Digest	Details of the VID usage.
Remote Management VLAN	Details of the management VLAN.
Link Aggregation Capability	Capabilities that supported by the link aggregation on the interface.
Link Aggregation Status	Status of the link aggregation.
Link Aggregation Port ID	Details of the link aggregation port identifier.
Auto Nego Support	Support of the auto nego on the interface.
Auto Nego Status	Status of the auto nego.
Auto Nego Capability	Capabilities that supported by the auto nego on the interface.
Operational MAU Type	Type of operational MAU on the interface.
Max Frame Size	Maximum frame size on the transit.

---

## show lldp interface

Use this command to display LLDP interface information.

### Command Syntax

```
show lldp interface IFNAME (nearest-bridge| non-tpmr-bridge| customer-bridge | )
    (neighbor| )
```

### Parameters

IFNAME	
	Display LLDP interface information for all agent
nearest-bridge	
	Display LLDP nearest bridge information
non-TPMR-bridge	
	Display LLDP non-TPMR-bridge information
customer-bridge	
	Display LLDP customer-bridge information
neighbor	
	Display LLDP neighbor details.

### Command Mode

Exec mode and Privileged Exec mode

### Applicability

This command was introduced before OcNOS version 1.3.

### Example

```
#show lldp interface eth0
Agent Mode : Customer-bridge
Enable (tx/rx): N/N
MED Enabled :N
Device Type: NOT_DEFINED
LLDP Agent traffic statistics:
Total frames transmitted: 0
Total entries aged: 0
Total frames recieved: 0
Total frames received in error: 0
Total frames discarded: 0
Total discarded TLVs: 0
Total unrecognised TLVs: 0

Agent Mode : Non-TPMR-bridge
Enable (tx/rx): N/N
MED Enabled :N
Device Type: NOT_DEFINED
LLDP Agent traffic statistics:
Total frames transmitted: 0
```

```

Total entries aged: 0
Total frames recieved: 0
Total frames received in error: 0
Total frames discarded: 0
Total discarded TLVs: 0
Total unrecognised TLVs: 0

Agent Mode : Nearest bridge
Enable (tx/rx): Y/Y
MED Enabled :N
Device Type: NOT_DEFINED
LLDP Agent traffic statistics:
Total frames transmitted: 2495
Total entries aged: 0
Total frames recieved: 0
Total frames received in error: 0
Total frames discarded: 0
Total discarded TLVs: 0
Total unrecognised TLVs: 0

```

Table 10-28 Shows the output details.

**Table 10-28: show lldp interface output details**

Entry	Description
Agent Mode	Agent mode enabled to the customer-bridge, Non-TPMR-bridge, and nearest bridge.
Enable (tx/rx)	Enables the transmit and receive on the interface.
Device Type	Type of device in the networks.
LLDP Agent traffic statistics	Statistics on exchanged LLDP frames between a device and neighbors.
Total frames transmitted	Number of frames transmitted in network.
Total entries aged	Number of aged entries in a networks.
Total frames received	Number of frames received from the neighbor network.
Total frames received in error	Number of frames not received from the neighbor network.
Total discarded TLVs	Number of TLVs discarded in transit.
Total unrecognised TLVs	Number of unrecognised TLVs in transit.

---

## snmp restart lldp

Use this command to restart SNMP in Link Layer Discovery Protocol (LLDP)

### Command Syntax

```
snmp restart lldp
```

### Parameters

None

### Command Mode

Configure mode

### Applicability

This command was introduced before OcNOS version 1.3.

### Examples

```
(config)#snmp restart lldp
```



## CHAPTER 11 Port Security Commands

---

This chapter describes the port security commands.

- [port-security](#)
- [show port-security](#)
- [switchport port-security](#)
- [switchport port-security logging](#)
- [switchport port-security mac-address](#)
- [switchport port-security maximum](#)

---

## port-security

Use this command to enable or disable port security globally.

### Command Syntax

```
port-security (enable | disable)
```

### Parameters

enable	Enable port security globally
disable	Disable port security globally

### Default

By default, port security is enabled globally.

### Command Mode

Configure mode

### Applicability

This command was introduced in OcNOS-SP version 4.0.

### Examples

```
(config)#port-security enable  
(config)#
```

---

## show port-security

Use this command to display the port security configuration for all interfaces or for a particular interface.

### Command Syntax

```
show port-security (interface IFNAME |)
```

### Parameters

IFNAME	Interface name
--------	----------------

### Default

None

### Command Mode

Exec mode

### Applicability

This command was introduced in OcNOS-SP version 4.0.

### Examples

```
#show port-security
Port port-security mode MAC limit CVLAN SVLAN static secure MAC
-----
ge1 dynamic          3          2          0000.0000.1112
                   10          0000.0000.3333
```

```
#show port-security interface ge1
Port Security Mode : Dynamic
Secure MAC limit : 3
Static Secure MAC list :
CVLAN SVLAN MAC Address
-----
2          0000.0000.1112
10         0000.0000.3333
```

---

## switchport port-security

Use this command to enable port security on an interface.

Use the `no` form of this command to disable port security on an interface. This command removes configured secured MAC, if any, on this interface.

**Note:** This command is supported for physical, LAG, and MLAG (active) interfaces only. Enabling port security on an interface removes learned MAC addresses of interfaces (whether learned by static or dynamic means), and then relearns the secure MAC addresses. Multicast MAC addresses are not considered as part of the MAC learning limit.

**Note:** This command is ignored when port security is already enabled on an interface.

### Command Syntax

```
switchport port-security (static |)
no switchport port-security
```

### Parameters

<code>static</code>	Static mode
---------------------	-------------

### Default

By default this feature is disabled; the default mode of port security is to dynamically learn. In dynamic mode, devices learn MAC addresses dynamically. You can program static MACs, however, dynamic MAC learning will not be allowed in static mode for port security.

### Command Mode

Interface mode

### Applicability

This command was introduced in OcNOS-SP version 4.0.

### Examples

```
#configure terminal
(config)#interface ge1
(config-if)#switchport
(config-if)#bridge-group 1
(config-if)#switchport mode hybrid
(config-if)#switchport hybrid allowed vlan all
(config-if)#switchport port-security
```

---

## switchport port-security logging

Use this command to enable violated MAC logging on a port security enabled interface.

Use the `disable` parameter with this command to disable violated mac logging on a port security enabled interface.

### Command Syntax

```
switchport port-security logging (enable | disable)
```

### Parameters

<code>enable</code>	Enable violated MAC logging
<code>disable</code>	Disable violated MAC logging

### Default

By default logging is disabled.

### Command Mode

Interface mode

### Applicability

This command was introduced in OcNOS-SP version 4.0.

### Examples

```
#configure terminal
(config)#interface ge1
(config-if)#switchport port-security logging enable
```

---

## switchport port-security mac-address

Use this command to add static secure MAC addresses.

Use the `no` form of this command to remove static secure MAC addresses.

### Command Syntax

```
switchport port-security mac-address XXXX.XXXX.XXXX
no switchport port-security mac-address XXXX.XXXX.XXXX
switchport port-security mac-address XXXX.XXXX.XXXX vlanId <2-4094>
no switchport port-security mac-address XXXX.XXXX.XXXX vlanId <2-4094>
switchport port-security mac-address XXXX.XXXX.XXXX svlanId <2-4094>
no switchport port-security mac-address XXXX.XXXX.XXXX svlanId <2-4094>
switchport port-security mac-address XXXX.XXXX.XXXX vlanId <2-4094> svlanId <2-4094>
no switchport port-security mac-address XXXX.XXXX.XXXX vlanId <2-4094> svlanId <2-4094>
```

### Parameters

XXXX.XXXX.XXXX	Static secure MAC address
vlanId	VLAN identifier
<2-4094>	VLAN identifier
svlanId	SVLAN identifier
<2-4094>	SVLAN identifier

### Default

N/A

### Command Mode

Interface mode

### Applicability

This command was introduced in OcNOS-SP version 4.0.

### Examples

```
#configure terminal
(config)#interface ge1
(config-if)#switchport port-security mac-address 0000.0000.1112 vlan 2
(config-if)# no switchport port-security mac-address 0000.0000.1112 vlan 2
(config)#interface ge2
(config-if)#switchport port-security mac-address 0000.1111.2222
(config-if)#no switchport port-security mac-address 0000.1111.2222
(config)#interface ge3
(config-if)#switchport port-security mac-address 0000.2222.3333 svlan 9
(config-if)#no switchport port-security mac-address 0000.2222.3333 svlan 9
(config)#interface ge4
```

```
(config-if)#switchport port-security mac-address 0000.2222.3333 vlan 23 svlan  
31  
(config-if)#no switchport port-security mac-address 0000.2222.3333 vlan 23  
svlan 31
```

---

## switchport port-security maximum

Use this command to set the MAC address learning limit for an interface.

Note: This command is supported for physical, LAG, and MLAG (active) interfaces only. When a newly configured maximum learn limit is less than the previous value, you must remove/flush-out the unwanted MACs to stop traffic forwarding from the unwanted source MAC addresses. MAC addresses can be removed using the [clear mac address-table](#) command.

Use `no` form cli to set the maximum limit back to default value 1.

### Command Syntax

```
switchport port-security maximum <1-1000>
no switchport port-security maximum
```

### Parameters

<1-1000>            Maximum MAC address learning limit

### Default

The default MAC address learning limit is 1.

### Command Mode

Interface mode

### Applicability

This command was introduced in OcNOS-SP version 4.0.

### Examples

```
#configure terminal
(config)#interface ge1
(config-if)#switchport port-security maximum 3
```

```
#configure terminal
(config)#interface po1
(config-if)#switchport port-security maximum 3
```

```
#configure terminal
(config)#interface mlag1
(config-if)#switchport port-security maximum 3
```



## CHAPTER 12 VLAN Cross-Connect Commands

---

This chapter contains VLAN cross-connect commands.

- `cross-connect`
- `disable`
- `outer-vlan VLAN_RANGE2 (inner-vlan VLAN_RANGE2 |)`
- `show cross-connect`

---

## cross-connect

Use this command to enter VLAN cross-connect mode to configure cross-connect parameters.

Use the `no` form of this command to delete a cross-connect.

### Command Syntax

```
cross-connect WORD
no cross-connect WORD
```

### Parameters

WORD                      Cross-connect name, length <1-255>

### Command Mode

Configure mode

### Applicability

This command was introduced in OcNOS version 1.3.6.

### Examples

```
#conf t
Enter configuration commands, one per line.  End with CNTL/Z.
(config)#cross-connect VC1
(config-XC)#
```

```
#conf t
Enter configuration commands, one per line.  End with CNTL/Z.
(config)#no cross-connect VC1
(config)#
```

---

## disable

Use this command to make a cross-connect administratively disabled or enabled.

### Command Syntax

```
disable
no disable
```

### Parameters

None

### Command Mode

Cross-connect mode

### Applicability

This command was introduced in OcNOS version 1.3.6.

### Examples

```
OcNOS#sh cross-connect
Cross-connect name : VC1
EP1:ce24/1      EP2:ce31/1      Admin Status:UP      Oper Status:UP
=====
| EP      | OVID    | IVID    | Rx packets  | Rx bytes   | Tx packets  | Tx bytes
|Interface Status|
=====
| EP1     | 100     | -       | 0           | 0          | 0           | 0
|UP      |
| EP2     | 100     | -       | 0           | 0          | 0           | 0
|UP      |
=====
cross-connect summary
Total XC      : 1
Admin Up     : 1
Admin Down   : 0
Total Rules  : 1
OcNOS#conf t
Enter configuration commands, one per line. End with CNTL/Z.
OcNOS(config)#cross-connect VC1
OcNOS(config-XC)#disable
2021 Mar 22 07:35:30.083 : OcNOS : NSM : CRITI : [VXC_DOWN_2]: Cross_Connect VC1 changed
state to down
OcNOS(config-XC)#end
OcNOS#sh cross-connect
ross-connect name : VC1
EP1:ce24/1      EP2:ce31/1      Admin Status:DOWN      Oper Status:DOWN
```

## VLAN Cross-Connect Commands

```
=====+
=====+
| EP      | OVID    | IVID    | Rx packets | Rx bytes  | Tx packets | Tx bytes
|Interface Status|
=====+
=====+
| EP1     | -       | -       | 0          | 0         | 0          | 0
|UP       |         |         |
| EP2     | -       | -       | 0          | 0         | 0          | 0
|UP       |         |         |
=====+
=====+
```

cross-connect summary

```
Total XC      : 1
Admin Up      : 0
Admin Down    : 1
Total Rules   : 0
```

OcNOS#conf t

Enter configuration commands, one per line. End with CNTL/Z.

OcNOS(config)#cross-connect VC1

OcNOS(config-XC)#no disable

OcNOS(config-XC)#2021 Mar 22 07:35:46.814 : OcNOS : NSM : CRITI : [VXC\_UP\_2]:

Cross\_Connect VC1 changed state to up

OcNOS#sh cross-connect

Cross-connect name : VC1

EP1:ce24/1 EP2:ce31/1 Admin Status:UP Oper Status:UP

```
=====+
=====+
| EP      | OVID    | IVID    | Rx packets | Rx bytes  | Tx packets | Tx bytes
|Interface Status|
=====+
=====+
| EP1*    | -       | -       | 47836      | 47836000  | 0          | 0
|UP       |         |         |
| EP2*    | -       | -       | 0          | 0         | 48149      | 48149000
|UP       |         |         |
=====+
=====+
```

cross-connect summary

```
Total XC      : 1
Admin Up      : 1
Admin Down    : 0
Total Rules   : 1
```

---

## outer-vlan VLAN\_RANGE2 (inner-vlan VLAN\_RANGE2 |)

Use this command to configure parameters for VLAN cross-connect.

### Command Syntax

```
outer-vlan VLAN_ID inner-vlan VLAN_ID ep1 IFNAME ep2 IFNAME
```

### Parameters

outer-vlan	Outer-VLAN associated with the cross-connect
VLAN ID	VLAN ID <2 - 4094>
inner-vlan	Inner-VLAN associated with the cross-connect
VLAN ID	VLAN ID <2 - 4094>
ep1	Interface for cross-connect endpoint 1
IFNAME	Interface name for endpoint 1
ep2	Interface for cross-connect endpoint 2
IFNAME	Interface name for endpoint 2

### Command Mode

Cross-connect mode

### Applicability

This command was introduced in OcNOS version 1.3.6.

### Examples

```
#conf t
```

Enter configuration commands, one per line. End with CNTL/Z. (config)#cross-connect VC1

```
(config-XC)#vlan ep1 ce25/1 ep2 ce16/1
```

```
(config-VXC)#outer-vlan 10 inner-vlan 20
```

```
(config-VXC)#
```

## show cross-connect

Use this command to display the VLAN cross-connect configuration.

### Command Syntax

```
show cross-connect
```

### Parameters

None

### Command Mode

Configure mode

### Applicability

This command was introduced in OcNOS version 1.3.6.

### Examples

```
OcNOS#sh cross-connect
```

```
Cross-connect name : VC1
```

```
EP1:ce25/1      EP2:ce16/1      Admin Status:UP      Oper Status:UP
```

```

=====
=====+
| EP      | OVID    | IVID    | Rx packets | Rx bytes  | Tx packets | Tx bytes
|Interface Status|
=====+
| EP1    | 100    | -      | 0          | 0         | 0         | 0
|UP      |        |        |            |           |           |
| EP2    | 100    | -      | 0          | 0         | 0         | 0
|UP      |        |        |            |           |           |
=====
=====+

```

```
cross-connect summary
```

```
Total XC      : 1
```

```
Admin Up      : 1
```

```
Admin Down    : 0
```

```
Total Rules   : 1
```

## CHAPTER 12 Unidirectional Link Detection Commands

---

This section describes the Unidirectional Link Detection (UDLD) commands.

- [udld](#)
- [udld message-time](#)
- [udld mode](#)
- [udld state](#)
- [show udld](#)
- [show udld interface](#)

---

## udld

Use this command to enable or disable the UDLD feature globally.

### Command Syntax

```
udld (enable | disable)
```

### Parameters

None

### Default

Disabled

### Command Mode

Configure mode

### Applicability

This command was introduced in OcNOS Version 5.0

### Examples

```
(config)#udld enable
```



---

## udld message-time

Use this command to set the UDLD message interval.

### Command Syntax

```
udld message-time <7-90>
```

### Parameters

<7-90>                      Interval time in seconds

### Default

15 seconds

### Command Mode

Configure mode

### Applicability

This command was introduced in OcNOS Version 5.0.

### Examples

```
config)#udld message-time 50
```

---

## udld mode

Use this command to configure UDLD mode as aggressive or normal.

### Command Syntax

```
udld mode (aggressive | normal)
```

### Parameters

aggressive	Aggressive mode
normal	Normal mode

### Default

N/A

### Command Mode

Interface mode

### Applicability

This command was introduced in OcNOS Version 5.0.

### Examples

```
(config-if)#udld mode aggressive
```

---

## udld state

Use this command to enable or disable the UDLD feature for an interface.

### Command Syntax

```
udld state (enable | disable)
```

### Parameters

None

### Default

Disabled

### Command Mode

Interface mode

### Applicability

This command was introduced in OcNOS Version 5.0.

### Examples

```
(config)#int xe7  
(config-if)#udld state enable
```

---

## show udd

Use this command to display UDLD statistic for all interface.

### Command Syntax

```
show udd
```

### Parameters

None

### Command Mode

Exec mode

### Applicability

This command was introduced in OcNOS-SP version 5.0.

### Examples

```
#show udd
UDLD                : Enable
Message Interval(sec) : 15
Port   UDLD Status  Mode                Link-Status
-----
xe7    Enable       Normal              Bi-Directional
```

[Table 12-29](#) explains the output fields.

**Table 12-29: show udd output fields**

Field	Description
UDLD	Whether UDLD is enabled or disabled
Message Interval	Message interval in seconds
Port	Interface name
UDLD Status	Whether UDLD is enabled or disabled on the interface
Mode	Whether the mode is aggressive or normal
Link-Status	State of the link: Unknown Loop-Back Neighbor Mismatch Unidirectional Undetermined Bi-Directional

---

## show udld interface

Use this command to display UDLD settings for particular interface.

### Command Syntax

```
show udld interface IFNAME
```

### Parameters

None

### Command Mode

Exec mode

### Applicability

This command was introduced in OcNOS-SP version 5.0.

### Examples

```
#show udld interface xe14
UDLD Status           : Enable
UDLD Mode             : Aggressive
Link-State            : Bi-Directional
#
```

[Table 12-30](#) explains the output fields.

**Table 12-30: show udld interface output fields**

Field	Description
UDLD Status	Whether UDLD is enabled or disabled
UDLD Mode	Whether the mode is aggressive or normal
Link-State	State of the link: Unknown Loop-Back Neighbor Mismatch Unidirectional Undetermined Bi-Directional



## CHAPTER 13 Layer 2 Control Protocols Tunneling Commands

This chapter is a reference for the Layer 2 Control Protocols (L2CP) tunneling commands:

- [clear l2protocol interface counters](#)
- [l2protocol](#)
- [l2protocol encapsulation dest-mac](#)
- [show l2protocol interface counters](#)
- [show l2protocol processing interface](#)

---

## clear l2protocol interface counters

This command allows you to clear the counters for numbers of packets peered, discarded and tunneled.

### Command Syntax

```
clear l2protocol interface (IFNAME|) counters (peer|discard|tunnel|tunnel-discard|)
```

### Parameters

peer	Clear stats for Peer protocol packets.
discard	Clear stats for Tunnel protocol packets.
tunnel	Clear stats for Tunnel protocol packets.
tunnel-discard	Clear stats for Tunnel discard protocol packets.

### Command Mode

Exec mode

### Applicability

This command was introduced before OcNOS-SP version 1.0.

### Examples

```
# clear l2protocol interface xel counters peer
```



---

## I2protocol

This command allows you to change the process of protocol to peer/discard/tunnel.

### Command Syntax

```
l2protocol (stp|lacp|efm|elmi|lldp|synce) (peer|discard|tunnel)
```

### Parameters

stp	Spanning Tree Protocols.
lacp	Link Aggregation (LACP).
efm	Ethernet first mile (Link OAM).
elmi	Ethernet local management interface.
lldp	Link layer discovery protocol.
synce	Link layer discovery protocol.
peer	Act as peer to the customer Device instance of the protocol.
discard	Discard the protocol data unit.
tunnel	Tunnel the Protocol data unit into the SVLAN.

### Default

Default process value is peer.

### Command Mode

Interface mode

### Applicability

This command was introduced before OcNOS-SP version 1.0.

### Examples

```
#configure terminal
(config)#interface xe1
(config-if)#switchport
(config-if)#bridge-group 1
(config-if)#switchport mode customer-edge access
(config-if)#l2protocol stp tunnel
(config-if)#l2protocol stp peer
(config-if)#l2protocol stp discard
```

## I2protocol encapsulation dest-mac

Use this command to change destination mac of tunneled I2 protocol packet. Allowed mac are 0100.C2CD.CDD0 or 0104.DFCD.CDD0.

Use the `no` parameter with this command to set default mac 0100.C2CD.CDD0.

Note: This command only applies to provider bridging. For more information, see [Chapter 24, Provider Bridging Configuration](#).

### Command Syntax

```
bridge <1-32> l2protocol encapsulation dest-mac XXXX.XXXX.XXXX
no bridge <1-32> l2protocol encapsulation dest-mac
```

### Parameters

bridge	Bridge group for bridging.
<1-32>	<1-32>
l2protocol	Configure Layer2 Protocol Tunneling.
encapsulation	Encapsulation of L2PT packet.
dest-mac	Encapsulation with destination mac.
XXXX.XXXX.XXXX	Destination Mac-address of L2PT tunneling (0100.C2CD.CDD0 or 0104.DFCD.CDD0).

### Command Mode

Configuration mode

### Applicability

This command is introduced in OcnOS-SP version 1.0.

### Examples

```
(config)#bridge 1 l2protocol encapsulation dest-mac ?
XXXX.XXXX.XXXX Destination Mac-address of L2PT tunneling (0100.C2CD.CDD0 or
0104.DFCD.CDD0)
(config)#bridge 1 l2protocol encapsulation dest-mac 0104.DFCD.CDD1
L2PT destination mac should be 0100.C2CD.CDD0 or 0104.DFCD.CDD0
(config)#bridge 1 l2protocol encapsulation dest-mac 0104.DFCD.CDD0
(config)#bridge 1 l2protocol encapsulation dest-mac 0100.C2CD.CDD0
(config)#bridge 1 l2protocol encapsulation dest-mac 0100.C2CD.CDD1
L2PT destination mac should be 0100.C2CD.CDD0 or 0104.DFCD.CDD0
(config)#

(config)#no bridge 1 l2protocol encapsulation dest-mac
(config)#show running-config | in bridge
bridge 1 protocol provider-rstp edge
vlan 2-10 type customer bridge 1 state enable
vlan 11-12 type service point-point bridge 1 state enable
cvlan registration table map1 bridge 1
bridge-group 1
bridge-group 1
(config)#
```

---

## show l2protocol interface counters

This command allows you to display the counters for numbers of packets peered, discarded and tunneled.

Note: In case of Provider-Bridging, tunneling will be done via slow path forwarding (via CPU).

And for other tunneling feature such as L2VPN, EVPN cases, L2protocol will follow hardware forwarding path to be tunneled.

Except Provider-Bridging feature, for other tunneling feature such as L2VPN/EVPN cases, tunnel counters will not be captured. Peering and discarding decision will be taken at CPU, hence, these counters will be captured with this show command.

### Command Syntax

```
show l2protocol interface (IFNAME|) counters (peer|discard|tunnel|tunnel-discard|)
```

### Parameters

peer	Display stats for Peer protocol packets.
discard	Display stats for Tunnel protocol packets.
tunnel	Display stats for Tunnel protocol packets.
tunnel-discard	Display stats for Tunnel discard protocol packets.

### Command Mode

Exec mode

### Applicability

This command was introduced before OcNOS-SP version 1.0.

### Examples

```
# show l2protocol interface xe1 counters peer
Interface xe1
Peer:      stp:      1

# show l2protocol interface xe1 counters
Interface xe1
Peer:      stp:      1
Discard:   stp:     10
Tunnel:    stp:      5
```

---

## show l2protocol processing interface

This command allows you to display the processing information on Layer 2 protocol interface.

### Command Syntax

```
show l2protocol processing interface IFNAME
```

### Parameters

IFNAME                    Interface name

### Command Mode

Exec mode and Privileged Exec mode

### Applicability

This command is introduced was before OcNOS-SP version 1.0.

### Examples

```
#show l2protocol processing interface xe1/1
```

Bridge	Interface Name	Protocol	Processing Status
=====	=====	=====	=====
1	xe1/1	stp	Tunnel
1	xe1/1	gmrp	Peer
1	xe1/1	gvrp	Peer
1	xe1/1	mrrp	Peer
1	xe1/1	mvrp	Peer
1	xe1/1	lacp	Peer
1	xe1/1	lldp	Peer
1	xe1/1	efm	Peer
1	xe1/1	elmi	Peer
1	xe1/1	ptp	Peer
1	xe1/1	synce	Peer

---

## CHAPTER 14 Provider Bridging Commands

---

This chapter describes the Provider Bridging (PB) commands.

IEEE 802.1ad standardizes the architecture and bridged protocols to allow Ethernet frames with multiple VLAN tags. Packets through a provider network are doubly tagged with both an:

- Inner (C-VLAN) tag which is the customer network VLAN identifier
- Outer (S-VLAN) tag which is the service provider network VLAN identifier
  - [bridge protocol provider-mstp](#)
  - [bridge protocol provider-rstp](#)
  - [cvlan registration table](#)
  - [cvlan svlan](#)
  - [dotad](#)
  - [show cvlan registration table](#)
  - [switchport customer-edge](#)
  - [switchport customer-edge hybrid](#)
  - [switchport customer-edge trunk](#)
  - [switchport customer-edge vlan registration](#)
  - [switchport customer-network allowed vlan](#)
  - [switchport customer-network vlan](#)
  - [switchport mode](#)
  - [switchport mode customer-edge](#)
  - [switchport mode customer-edge hybrid acceptable-frame-type](#)
  - [switchport provider-network](#)
  - [switchport provider-network isolated-vlan](#)
  - [vlan type](#)
  - [vlan type customer](#)

---

## bridge protocol provider-mstp

Use this command to create a provider multiple spanning-tree protocol (MSTP) bridge. MSTP bridges can have different spanning-tree topologies for different VLANs inside a region of similar MSTP bridges.

Using this command creates an instance of the spanning tree, and associates the VLANs specified with that instance. A bridge created by this command forms its own separate region.

The multiple spanning tree protocol, like the rapid spanning tree protocol, provides rapid reconfiguration features, while providing load-balancing capability.

### Command Syntax

```
bridge <1-32> protocol provider-mstp (edge|)
```

### Parameters

<1-32>	Bridge identifier.
edge	Configure as an edge bridge.

### Command Mode

Configure mode

### Applicability

This command was introduced before OcNOS version 1.3.

### Example

```
#configure terminal  
(config)#bridge 2 protocol provider-mstp edge
```

---

## bridge protocol provider-rstp

Use this command to add an IEEE 802.1D-2004 Rapid Spanning Tree Protocol (RSTP) bridge.

After creating a bridge instance, add interfaces to the bridge using the `bridge-group` command. Bring the bridge instance into operation with the `no shutdown` command in interface mode.

### Command Syntax

```
bridge <1-32> protocol provider-rstp (edge|)
```

### Parameters

<code>&lt;1-32&gt;</code>	Bridge identifier.
<code>edge</code>	Configure as an edge bridge.

### Command Mode

Configure mode

### Applicability

This command was introduced before OcnOS version 1.3.

### Example

```
#configure terminal  
(config)#bridge 2 protocol provider-rstp edge
```

---

## cvlan registration table

Use this command to create a customer VLAN (CVLAN) registration table that maps between CVLANs and service provider VLANs (SVLANs).

Use the `no` parameter with this command to delete the CVLAN registration table.

### Command Syntax

```
cvlan registration table WORD bridge <1-32>
no cvlan registration table WORD bridge <1-32>
```

### Parameters

WORD	Name of the CVLAN registration table.
<1-32>	Specify a bridge ID.

### Command Mode

Configure mode

### Applicability

This command was introduced before OcNOS version 1.3.

### Example

```
#configure terminal
(config)#cvlan registration table customer1
(config-cvlan-registration)#
```



---

## cvlan svlan

Use this command to map one or more customer VLANs (CVLANs) to a service provider VLAN (SVLAN).

To update the optional QoS parameters `cos-to-queue` and `remark-cos`, execute the complete command along with the optional parameters. To remove these options, execute the same command by removing the optional parameters.

Refer `qos profile` commands from configuration guide for more details about qos profiles.

Use the `no` forms of this command to delete a mapping.

### Command Syntax

```
cvlan VLAN_RANGE2 (cvlan VLAN_ID|) svlan VLAN_ID ({untagged-pep|untagged-
  cep|}) ({cos-to-queue NAME | remark-cos|})
no cvlan VLAN_RANGE2  svlan VLAN_ID
```

### Parameters

<code>cvlan</code>	CVLAN
<code>VLAN_RANGE2</code>	VLAN identifier <1-4094> or range such as 2-5,10 or 2-5,7-19
<code>cvlan</code>	Translation of CVID
<code>VLAN_ID</code>	Translated CVID <1-4095>
<code>svlan</code>	SVLAN corresponding to the C-VLAN
<code>VLAN_ID</code>	VLAN identifier 1-4094>
<code>untagged-pep</code>	Provider edge port is untagged for this CVLAN
<code>untagged-cep</code>	Customer edge port is untagged for this CVLAN
<code>cos-to-queue</code>	Configure cos-to-queue map for cvlan
<code>NAME</code>	Ingress profile to modify queue/color on basis of c-cos
<code>remark-cos</code>	Remark Egress COS

### Command Mode

CVLAN Registration mode

### Applicability

This command was introduced before OcNOS version 1.3 and updated in OcNOS-SP version 1.0.

### Example

```
#configure terminal
(config)#cvlan registration table customer1 bridge 1
(config-cvlan-registration)#cvlan 2 svlan 3
(config-cvlan-registration)#cvlan 3 svlan 3 cos-to-queue c1 remark-cos
(config-cvlan-registration)#cvlan 100 cvlan 101 svlan 200 cos-to-queue p1
remark-cos
(config-cvlanregistration)#cvlan 3 svlan 3 remark-cos
(config-cvlan-registration)#cvlan 4 svlan 5 untagged-pep
(config-cvlan-registration)#cvlan 5 svlan 6 untagged-cep
(config-cvlan-registration)#no cvlan 3 svlan 3
```

## Provider Bridging Commands

---

```
(config-cvlan-registration)#cvlan 23 svlan 31 untagged-pep untagged-cep cos-  
to-queue pl remark-cos  
(config-cvlan-registration)#cvlan 15-16 svlan 18 untagged-cep remark-cos
```

## dotad

This command allows you to change the TPID for a port.

Use the no form of this command to unset the TPID to default value.

### Command Syntax

```
dotad ethertype ETHERTYPE
no dotad ethertype
```

### Parameters

dotad	Set the switching characteristics of the Layer2 dot1q header.
ETHERTYPE	Ethertype value for outer tag (Allowed ethertype values are 0x8100 (default) or 0x88a8 Or 0x9100 or 0x9200)

### Default

The default TPID value is 8100.

### Command Mode

Interface Mode

### Applicability

This command was introduced before OcnOS-SP version 1.0.

### Examples

```
#configure terminal
(config)#interface xe1
(config-if)# dotad ethertype 0x88a8
(config-if)# no dotad ethertype
```

## show cvlan registration table

Use this command to display the CVLAN registration table.

### Command Syntax

```
show cvlan registration table (WORD|bridge <1-32>|WORD bridge <1-32>|)
```

### Parameters

WORD CVLAN registration table name.  
 <1-32> Bridge identifier

### Command Mode

Exec mode

### Applicability

This command was introduced before OcNOS version 1.3.

### Example

```
#sh cvlan registration table bridge 1
Bridge          Table Name      Port List
=====
 1              map            xe17

CVLAN ID       T-CVLAN ID     SVLAN ID       Profile Name    Egress remark-Cos
=====
 100           101            200            p1              Yes
```

[Table 14-31](#) explains the output fields.

**Table 14-31: show cvlan registration table output**

Entry	Description
Bridge	ID number of the bridge associated with the Customer VLAN (CVLAN).
Table Name	ID of the CVLAN registration table.
Port List	List of ports used by this CVLAN (including Link aggregators).
CVLAN ID	ID number of the CVLAN.
T-CVLAN ID	Translation CVLAN ID.
SVLAN ID	ID number of the Service VLAN (SVLAN) associated with the CVLAN.
Profile Name	cos-to-queue profile name.
Egress remark-Cos	Remark Egress Cos

---

## switchport customer-edge

Use this command to set the switching characteristics of the layer 2 interface and the default customer VLAN.

Use the `no` form of this command to remove a customer VLAN.

### Command Syntax

```
switchport customer-edge (access|hybrid) vlan <2-4094>
no switchport customer-edge (access|hybrid) vlan
```

### Parameters

<code>access</code>	Set the layer 2 interface as access.
<code>hybrid</code>	Set the layer 2 interface as hybrid.
<code>&lt;2-4094&gt;</code>	Set the default VID for the interface.

### Command Mode

Interface mode

### Applicability

This command was introduced before OcnOS version 1.3.

### Examples

```
#configure terminal
(config)#interface eth0
(config-if)#switchport customer-edge access vlan 3

(config)#interface eth0
(config-if)#no switchport customer-edge access vlan
```

---

## switchport customer-edge hybrid

Use this command to set the switching characteristics of the Layer 2 customer-facing interface to hybrid. Both tagged and untagged frames will be classified over hybrid interfaces.

### Command Syntax

```
switchport customer-edge hybrid allowed vlan add VLAN_ID
switchport customer-edge hybrid allowed vlan remove VLAN_ID
switchport customer-edge hybrid allowed vlan all
switchport customer-edge hybrid allowed vlan none
```

### Parameters

add	Add a VLAN to transmit and receive through the Layer 2 interface.
VLAN_ID	ID of the VLAN <2-4094>.
remove	Remove a VLAN from the member set.
VLAN_ID	ID of the VLAN <2-4094>.
all	Allow all VLANs to transmit and receive through the Layer 2 interface.
none	Allow no VLANs to transmit and receive through the Layer 2 interface.

### Command Mode

Interface mode

### Applicability

This command was introduced before OcnOS version 1.3.

### Examples

```
(config)#interface eth0
(config-if)#switchport customer-edge hybrid allowed vlan add 2
```

---

## switchport customer-edge trunk

Use this command to set the Layer2 interface as trunk.

### Command Syntax

```
switchport customer-edge trunk allowed vlan add VLAN_ID
switchport customer-edge trunk allowed vlan remove VLAN_ID
switchport customer-edge trunk allowed vlan all
switchport customer-edge trunk allowed vlan none
```

### Parameters

add	Add a VLAN to the member set.
VLAN_ID	Specify a VLAN ID <2-4094>
remove	Remove a VLAN from the member set.
all	Allow all VLANs to transmit and receive through the Layer 2 interface.
none	Allow no VLANs to transmit and receive through the Layer 2 interface.

### Command Mode

Interface mode

### Applicability

This command was introduced before OcnOS version 1.3.

### Examples

```
#configure terminal
(config)#interface eth1
(config-if)#switchport customer-edge trunk allowed vlan add 12
```

---

## switchport customer-edge vlan registration

Use this command to configure the VLAN registration parameters.

Use the `no` parameter with this command to delete the mapping from the interface.

### Command Syntax

```
switchport customer-edge vlan registration WORD
no switchport customer-edge vlan registration
```

### Parameters

`WORD`                      Name of the CVLAN registration table.

### Command Mode

Interface mode

### Applicability

This command was introduced before OcNOS version 1.3.

### Example

```
#configure terminal
(config)#interface eth1
(config-if)#switchport customer-edge vlan registration customer1
```



---

## switchport customer-network allowed vlan

Use this command to add SVLAN IDs to the Customer Network Port.

### Command Syntax

```
switchport customer-network allowed vlan add VLAN_RANGE
```

### Parameters

VLAN\_RANGE      VLAN identifier <1-4094> or range such as 2-5,10 or 2-5,7-19.

### Command Mode

Interface mode

### Applicability

This command was introduced before OcnOS version 6.2.0.

### Examples

In this example, the xe1 interface allows S-TAG 100-200 and 400 traffic from customer.

```
(config)#interface xe1
(config-if)#switchport
(config-if)#dot1ad ethertype 0x88a8
(config-if)#bridge-group 1
(config-if)#switchport mode customer-network
      (config-if)#switchport customer-network allowed vlan add 100-200,400
```

---

## switchport customer-network vlan

Use this command to set the default SVLAN ID for the Customer Network Port.

### Command Syntax

```
switchport customer-network vlan <2-4094>
no switchport customer-network vlan
```

### Parameters

<2-4094>            Set the default VLAN ID for the interface.

### Default

Default Customer Network VLAN is 1.

### Command Mode

Interface mode

### Applicability

This command was introduced before OcNOS version 6.2.0

### Examples

In this example, the xe1 interface allows C-TAG/untagged traffic from customers, adding SVLAN ID 100 before forwarding to the provider network. While egressing out, the SVLAN ID 100 will be stripped out.

```
(config)#interface xe1
(config-if)#switchport
(config-if)#dot1ad ethertype 0x88a8
(config-if)#bridge-group 1
(config-if)#switchport mode customer-network
(config-if)#switchport customer-network allowed vlan add 100
(config-if)#switchport customer-network vlan 100
```

---

## switchport mode

Use this command to set the switching characteristics of the Layer 2 interface.

### Command Syntax

```
switchport mode (provider-network|customer-edge|customer-network)
```

### Parameters

```
provider-network  Provider network.  
customer-edge    Customer edge.  
customer-network Customer network.
```

### Command Mode

Interface mode

### Applicability

This command was introduced before OcnOS version 1.3.

### Example

```
#configure terminal  
(config)#interface eth0  
(config-if)#switchport mode provider-network
```

---

## switchport mode customer-edge

Use this command to set the switching characteristics of the Layer 2 customer facing interface and classify only untagged frames. Received frames are classified based on the VLAN characteristics, then accepted or discarded based on the specified filtering criteria.

### Command Syntax

```
switchport mode customer-edge (access|hybrid|trunk)
switchport mode customer-edge (access|hybrid|trunk)
```

### Parameters

access	Set the layer 2 interface as access.
hybrid	Set the layer 2 interface as hybrid.
trunk	Set the layer 2 interface as trunk.

### Command Mode

Interface mode

### Applicability

This command was introduced before OcnOS version 1.3.

### Example

```
#configure terminal
(config)#interface eth0
(config-if)#switchport mode customer-edge access
```

---

## switchport mode customer-edge hybrid acceptable-frame-type

Use this command to set the layer 2 interface acceptable frames types. This processing occurs after VLAN classification.

### Command Syntax

```
switchport mode customer-edge hybrid acceptable-frame-type (all|vlan-tagged)
```

### Parameters

all	Set all frames can be received.
vlan-tagged	Set only VLAN-tagged frames can be received.

### Command Mode

Interface mode

### Applicability

This command was introduced before OcnOS version 1.3.

### Example

```
#configure terminal
(config)#interface eth0
(config-if)#switchport mode customer-edge hybrid acceptable-frame-type vlan-
tagged
```

---

## switchport provider-network

Use this command to set the switching characteristics of the provider-network interface.

### Command Syntax

```
switchport provider-network allowed vlan add VLAN_RANGE2
switchport provider-network allowed vlan remove VLAN_RANGE2
switchport provider-network allowed vlan except VLAN_RANGE2
switchport provider-network allowed vlan all
switchport provider-network allowed vlan none
```

### Parameters

add	Add a VLAN to transmit and receive through the Layer 2 interface.
VLAN_RANGE2	VLAN ID 1-4094 or range(s): 2-5 10 or 2-5 7-20.
remove	Remove a VLAN from the member set.
VLAN_RANGE2	VLAN ID 1-4094 or range(s): 2-5 10 or 2-5 7-20.
Except	All VLANs except these VLANs are part of the member set.
VLAN_RANGE2	VLAN ID 1-4094 or range(s): 2-5 10 or 2-5 7-20.
all	Allow all VLANs to transmit and receive through the Layer 2 interface.
none	Allow no VLANs to transmit and receive through the Layer 2 interface.

### Command Mode

Interface mode

### Applicability

This command was introduced before OcNOS version 1.3.

### Examples

```
(config)#interface eth0
(config-if)#switchport provider-network allowed vlan add 2
```

---

## switchport provider-network isolated-vlan

Use this command to attach a VLAN as an isolated VLAN for a provider network port.

Using an isolated VLAN for PNP ports on a switch can forward all frames received from the PNP port to all other PNP ports. However, if VLANs are configured to be isolated, they can traverse PNP port without sharing any of their frames.

Use the `no` form of this command to remove an isolated VLAN for a provider network port.

### Command Syntax

```
switchport provider-network isolated-vlan VLAN_RANGE
no switchport provider-network isolated-vlan VLAN_RANGE
```

### Parameters

VLAN\_RANGE            VLAN identifier <2-4094> or range such as 2-5,10 or 2-5,7-19

### Command Mode

Interface mode

### Applicability

This command was introduced in OcNOS-SP version 1.0.

### Example

```
#configure terminal
(config)#bridge 1 protocol provider-rstp
(config)#vlan database
(config-vlan)#vlan 2-10 type service point-point bridge 1 state enable
(config-vlan)#exit
(config)#interface xe0
(config-if)#switchport
(config-if)#bridge-group 1
(config-if)#switchport provider-network allowed vlan all
(config-if)#switchport provider-network isolated-vlan 2-10
```

---

## switchport provider-network vlan translation

Use this command to add a translation table entry for CVLAN and SVLAN on a provider network port.

Use the `no` form of this command to delete a translation table entry for CVLAN and SVLAN on a provider network port.

### Command Syntax

```
switchport provider-network vlan translation (cvlan <2-4094>| ) svlan <2-4094>
  (cvlan <2-4094> | ) svlan <2-4094>
no switchport (provider-network) vlan translation svlan VLAN_ID svlan VLAN_ID
no switchport (provider-network) vlan translation cvlan <1-4095> svlan <1-4095>
```

### Parameters

<code>cvlan</code>	CVLAN to translate
<code>&lt;2-4094&gt;</code>	CVLAN identifier to translate
<code>svlan</code>	SVLAN to translate
<code>&lt;2-4094&gt;</code>	SVLAN identifier to translate
<code>cvlan</code>	Translated CVLAN
<code>&lt;2-4094&gt;</code>	Translated CVLAN identifier
<code>svlan</code>	Translated SVLAN
<code>&lt;2-4094&gt;</code>	Translated SVLAN identifier
<code>scos</code>	Class of Service in the Priority Code Point (PCP) field of the service provider tag (STAG)
<code>&lt;0-7&gt;</code>	Class-of-service value
<code>scfi</code>	Canonical Format Indicator in the Drop Eligible Indicator (DEI) field of the STAG
<code>&lt;0-1&gt;</code>	Canonical Format Indicator value
<code>ccos</code>	Class of Service in the PCP field of the customer tag (CTAG)
<code>&lt;0-7&gt;</code>	Class-of-service value
<code>ccfi</code>	Canonical Format Indicator in the DEI field of the CTAG
<code>&lt;0-1&gt;</code>	Canonical Format Indicator value

### Command Mode

Interface mode

### Applicability

This command was introduced before OcNOS version 1.3.

### Example

```
#configure terminal
(config)#interface eth1
(config-if)#switchport
(config-if)#bridge-group 1
(config-if)#switchport mode provider-network
(config-if)#switchport provider-network allowed vlan all
```



```
(config-if)#switchport provider-network vlan translation cvlan 2 svlan 3 cvlan  
4 svlan 5
```

---

## vlan type

This command allows you to create a single/range of VLAN's on provide/edge bridge.

Use the no form of this command to delete the VLAN.

### Command Syntax

```
vlan VLAN_RANGE type customer bridge <1-32>
vlan VLAN_RANGE type customer bridge <1-32> name WORD
vlan VLAN_RANGE type customer bridge <1-32> state (enable | disable)
vlan VLAN_RANGE type service point-point bridge <1-32>
vlan VLAN_RANGE type service point-point bridge <1-32> name WORD
vlan VLAN_RANGE type service point-point bridge <1-32> state (enable | disable)

no vlan VLAN_RANGE type customer bridge <1-32>
no vlan VLAN_RANGE type service bridge <1-32>
```

### Parameters

VLAN_RANGE	VLAN identifier <2-4094> or range such as 2-5,10 or 2-5,7-19
customer	Identifies the Customer VLAN
bridge	Specify the bridge group ID in the range <1-32>.
name	The ASCII name of the VLAN. Maximum length allowed is 16 characters.
point-point	Sets the VLAN connectivity mode to point-to-point
WORD	ASCII name of the VLAN.
state	Indicates the operational state of the VLAN.
enable	Sets VLAN into an enable state.
disable	Sets VLAN into a disable state.

### Command Mode

Configuration Mode

### Applicability

This command was introduced before OcNOS version 1.3.

### Examples

```
(config)vlan 2,4,5-6 customer bridge 2
(config)vlan 10-12 service type point-point bridge 3
```

---

## vlan type customer

Use this command to configure VLANs of type customer, to enable or disable the state of the VLANs, and to configure the name for VLANs.

Use the `no` form of this command to remove the VLAN type.

### Command Syntax

```
vlan <2-4094> type customer bridge <1-32>
vlan <2-4094> type customer bridge <1-32> state (enable|disable)
vlan <2-4094> type customer bridge <1-32> name WORD
no vlan <2-4094> type customer bridge <1-32>
```

### Parameters

<2-4094>	The VID of the VLAN that will be enabled or disabled on the bridge <2-4094>.
type	Identifies the VLAN as a customer, service, or VLAN.
customer	Identifies the Customer VLAN
bridge	Indicates a Service VLAN <1-32>.
name	The ASCII name of the VLAN. Maximum length allowed is 16 characters.
state	Indicates the operational state of the VLAN.
enable	Sets VLAN into an enable state.
disable	Sets VLAN into a disable state.
WORD	ASCII name of the VLAN.

### Command Mode

VLAN Configuration mode

### Applicability

This command was introduced before OcNOS version 1.3.

### Examples

```
#configure terminal
(config)#vlan database
(config-vlan)#vlan 12 type customer bridge 1 name new state enable
```



# Data Center Bridging Command Reference



## CHAPTER 1 Priority-based Flow Control Commands

---

This section lists and describes the commands that can be used to configure Priority-based Flow Control (PFC) in a Data Center Bridging (DCB) environment. It includes the following commands:

- [priority-flow-control accept-peer-config](#)
- [priority-flow-control advertise-local-config](#)
- [priority-flow-control enable](#)
- [priority-flow-control cap](#)
- [priority-flow-control enable priority](#)
- [priority-flow-control link-delay-allowance](#)
- [priority-flow-control mode](#)
- [show priority-flow-control details](#)
- [show priority-flow-control statistics](#)

---

## priority-flow-control accept-peer-config

Use this command to enable willing mode for PFC on the interface.  
If willing is enabled, then by default advertise mode is also enabled.  
Use the `no` form of this command to disable willing mode.

### Command Syntax

```
priority-flow-control accept-peer-config  
no priority-flow-control accept-peer-config
```

### Parameters

None

### Default

By default, willing mode for PFC on the interface is disabled. If willing is enabled, then by default advertise mode is also enabled.

### Command Mode

Interface mode

### Applicability

This command was introduced before OcNOS version 1.3.

### Examples

```
#configure terminal  
(config)#interface eth1  
(config-if)#priority-flow-control accept-peer-config
```



---

## priority-flow-control advertise-local-config

Use this command to enable advertising mode for PFC on the interface.

Use the `no` form of this command to disable advertising mode.

### Command Syntax

```
priority-flow-control advertise-local-config  
no priority-flow-control advertise-local-config
```

### Parameters

None

### Default

By default, advertising mode for PFC on the interface is disabled. If `willing` is enabled, then by default advertise mode is also enabled.

### Command Mode

Interface mode

### Applicability

This command was introduced before OcNOS version 1.3.

### Examples

```
#configure terminal  
(config)#interface eth1  
(config-if)#priority-flow-control advertise-local-config
```

---

## priority-flow-control enable

Use this command to enable Priority-based Flow Control (PFC) on a switch (bridge).

Use the `no` form of this command to disable PFC.

### Command Syntax

```
priority-flow-control enable bridge <1-32>
no priority-flow-control bridge <1-32>
```

### Parameters

<1-32>                      Bridge ID.

### Default

By default, PFC is disabled.

### Command Mode

Configure mode

### Default

PFC is disabled by default.

### Applicability

This command was introduced before OcNOS version 1.3.

### Example

```
#configure terminal
(config)#priority-flow-control enable bridge 32

#configure terminal
(config)#no priority-flow-control bridge 32
```

---

## priority-flow-control cap

Use this command to configure a priority-flow-control cap for the number of priorities allowed on an interface.

Use the `no` parameter along with this command to return the value to its default level.

### Command Syntax

```
priority-flow-control cap <0-8>
no priority-flow-control cap
```

### Parameters

<0-8>                      Select a cap value. Zero indicates that there is no limitations.

### Default

By default, priority-flow-control cap value is 8.

### Command Mode

Interface mode

### Applicability

This command was introduced before OcNOS version 1.3.

### Examples

```
#configure terminal
(config)#interface eth2
(config-if)#priority-flow-control cap 7
```

---

## priority-flow-control enable priority

Use this command to enable the PFC at the interface level for a specific priority.

Use the `no` parameter along with this command to disable PFC for a priority.

### Command Syntax

```
priority-flow-control enable priority <0-7> (<0-7>(<0-7>(<0-7> (<0-7>(<0-7>(<0-7>(<0-7>|)|)|)|)|)|)
```

```
no priority-flow-control enable priority <0-7> (<0-7>(<0-7>(<0-7>(<0-7>(<0-7>(<0-7>(<0-7>|)|)|)|)|)|)
```

### Parameter

<0-7> Traffic-priority value. You can specify up to seven priorities.

### Default

None

### Command Mode

Interface mode

### Default

PFC is disabled by default.

### Applicability

This command was introduced before OcNOS version 1.3.

### Examples

```
(config)#interface eth1
(config-if)#priority-flow-control enable priority 1 2 3 4 5 6 7

(config)#interface eth1
(config-if)#no priority-flow-control enable priority 2 3 4
```

---

## priority-flow-control link-delay-allowance

Use this command to set PFC link delay allowance on an interface. This command provides allowance for round-trip propagation delay of the link in bits; moreover, it is one of the factors that determines when to trigger PAUSE.

Use the `no` parameter along with this command to unset PFC link delay allowance on an interface.

### Command Syntax

```
priority-flow-control link-delay-allowance <0-4294967296>  
no priority-flow-control link-delay-allowance
```

### Parameter

<0-4294967296> Link characteristics that affect the link delay (for example, link length).

### Command Mode

Interface mode

### Default

Default value is zero.

### Applicability

This command was introduced before OcNOS version 1.3.

### Example

```
#configure terminal  
(config)#interface eth1  
(config-if)#priority-flow-control link-delay-allowance 5  
  
(config)#interface eth1  
(config-if)#no priority-flow-control link-delay-allowance
```

---

## priority-flow-control mode

Use this command to enable Priority-based Flow Control (PFC) on an interface.

Use the `no` form of this command to disable PFC on an interface.

### Command Syntax

```
priority-flow-control mode (on | auto)
no priority-flow-control
```

### Parameters

<code>auto</code>	Negotiate PFC capabilities.
<code>on</code>	Force-enable PFC, overriding negotiation.

### Default

By default, PFC is disabled.

### Command Mode

Interface mode

### Default

PFC is disabled by default.

### Applicability

This command was introduced before OcnOS version 1.3.

### Example

```
#configure terminal
(config)#interface eth1
(config-if)#priority-flow-control mode auto
```

---

## show priority-flow-control details

Use this command to display the PFC details for a specified interface or bridge.

### Command Syntax

```
show priority-flow-control details ((interface IFNAME) | (bridge <1-32>))
```

### Parameters

IFNAME	Name of the input or output interface.
<1-32>	Specify a bridge ID.

### Default

None

### Command Mode

Exec mode

### Applicability

This command was introduced before OcNOS version 1.3.

### Example

```
#show priority-flow-control details interface eth1
bridge : 2
priority flow control : on
interface : eth1
```

Admin Configuration

mode	advertise	willing	cap	link	delay	allowance	priorities
on	on	off	5	128			2 3 4 5

=====

Operational Configuration

state	cap	link	delay	allowance	priorities
on	5	128			2 3 4 5

=====

**Table 1-32: Show priority-flow control details output**

Entry	Description
bridge	The bridge number to which this interface is associated (1-32).
priority flow control	Show whether priority flow control is either <code>on</code> or <code>off</code> .
interface	The interface name.
Admin Configuration	The configuration as entered on this device.
mode	The priority flow control operating mode – <code>on</code> , <code>off</code> , or <code>auto</code> .
advertise	Status of advertisement of the configuration to the peer device.
willing	The willingness of the local interface to learn the PFC configuration from the peer. Values are either <code>on</code> or <code>off</code> .
cap	Cap is a limit set that specifies the maximum number of PFC priorities.
link delay allowance	The allowance made for round-trip propagation delay of the link in bits.
Priorities	Shows the PFCs that have been to be used on the priorities.
Operational Configuration	The actual configuration that exists between this device and its PFC peer.
state	Shows whether PFC is functioning. Values are <code>on</code> , <code>off</code> , or <code>auto</code> .
cap	Cap is the limit that specifies the maximum number of PFC priorities.
link delay allowance	The allowance being used for round-trip propagation delay of the link in bits.
priorities	The PFCs actually being used by this device and its peer.



---

## show priority-flow-control statistics

Use this command to display statistics about the number of PFC Pause frames sent and received for a specified interface or bridge. If you do not specify a bridge or interface, this commands shows statistics for the bridge.

### Command Syntax

```
show priority-flow-control statistics ((interface IFNAME) | (bridge <1-32>))
```

### Parameters

<1-32>	Specify bridge ID.
IFNAME	Name of the input or output interface.

### Default

None

### Command Mode

Exec mode

### Applicability

This command was introduced before OcnOS version 1.3.

### Example

```
#show priority-flow-control statistics interface eth1
bridge : 2
interface : eth1
pause sent      pause received
=====
59680614996248372055834574861
```



# Index

## Numerics

### 802.1x Commands

- auth-mac dynamic-vlan-creation disable 546
- auth-mac system-auth-ctrl 549
- debug dot1x 549
- dot1x port-control 551
- dot1x protocol-version 552
- dot1x quiet-period 553
- dot1x reauthentication 555
- dot1x reauthMax 554
- dot1x system-auth-ctrl 556
- dot1x timeout re-authperiod 557
- dot1x timeout server-timeout 558
- dot1x timeout supp-timeout 559
- dot1x timeout tx-period 560
- ip radius source-interface 561
- radius-server host 562
- show debugging dot1x 565
- show dot1x 567

## A

- authentication 29
- auth-mac dynamic-vlan-creation disable 546
- auth-mac system-auth-ctrl 549

## B

- begin modifier 20
- BGP community value
  - command syntax 18
- braces
  - command syntax 17
- bridge acquire 340
- bridge address 341
- bridge ageing-time 342
- bridge cisco-interoperability 373
- Bridge commands
  - bridge acquire 340
  - bridge address 341
  - bridge ageing-time 342
  - bridge protocol mstp 379
  - bridge protocol rstp 380
  - clear mac address-table 355
  - show interface switchport bridge 362
  - switchport 368
- bridge forward-time 343
- bridge instance priority 375
- bridge max-age 346
- bridge max-hops 347
- bridge multiple-spanning-tree enable 377
- bridge priority 348
- bridge protocol mstp 379
- bridge protocol provider-rstp 653

- bridge protocol rpvst+ 443
- bridge protocol rstp 380
- bridge rapid-spanning-tree enable 382
- bridge region 383
- bridge revision 384
- bridge shutdown 349
- bridge spanning-tree enable 385
- bridge spanning-tree errdisable-timeout enable 386
- bridge spanning-tree portfast bpdu-filter 389
- bridge te-msti 391
- bridge transmit-holdcount 350
- bridge-group instance 392
- bridge-group instance path-cost 393
- bridge-group path-cost 352
- bridge-group priority 353
- bridge-group vlan 442

## C

- clear mac address-table 355
- clear spanning-tree detected protocols 398
- command abbreviations 16
- command completion 16
- command line
  - errors 16
  - help 15
  - keyboard operations 19
- command modes 23
  - configure 23
  - exec 23
  - interface 23
  - privileged exec 23
  - router 23
- command negation 17
- command syntax
  - ? 18
  - . 18
  - () 17
  - { } 17
  - | 17
  - A.B.C.D/M 18
  - AA:NN 18
  - BGP community value 18
  - braces 17
  - conventions 17
  - curly brackets 17
  - HH:MM:SS 18
  - IFNAME 18
  - interface name 18
  - IPv4 address 18
  - IPv6 address 18
  - LINE 18
  - lowercase 17
  - MAC address 18
  - monospaced font 17
  - numeric range 18
  - parentheses 17
  - parentheses 17
  - period 18

- question mark 18
- square brackets 18
- time 18
- uppercase 17
- variable placeholders 18
- vertical bars 17
- WORD 18
- X:X::X:X 18
- X:X::X:X/M 18
- XX:XX:XX:XX:XX:XX 18
- common commands
  - errdisable 328
  - errdisable timeout 330
- Common NSM Layer 2 commands
  - storm-control level 435
- configuration
  - disable spanning tree 41
- configure
  - 802.1x authentication 29
  - LACP 61
  - LLDP 107
  - MSTP 163
  - Provider Bridging 249
  - RSTP 207
  - STP 217
- configure mode 23
- curly brackets
  - command syntax 17
- customer-spanning-tree customer-edge path-cost 400
- customer-spanning-tree customer-edge priority 401
- customer-spanning-tree forward-time 402
- customer-spanning-tree hello-time 403
- customer-spanning-tree max-age 404
- customer-spanning-tree priority 405
- customer-spanning-tree provider-edge path-cost 406
- customer-spanning-tree provider-edge priority 407
- customer-spanning-tree transmit-holdcount 408
- cvlan registration table 654
- cvlan svlan 655

## D

- debug dot1x 549
- debug lacp command 457
- debug mcec 485
- debug mstp 409
- disable spanning tree
  - configuration 41
  - spanning-tree te-msti configuration 434
- domain hello timeout 487
- domain priority 488
- domain system number 489
- domain-address 486
- dot1x port-control 551
- dot1x protocol-version 552
- dot1x quiet-period 553
- dot1x reauthentication 555
- dot1x reauthMax 554

- dot1x system-auth-control 556
- dot1x timeout re-authperiod 557
- dot1x timeout server-timeout 558
- dot1x timeout supp-timeout 559
- dot1x timeout tx-period 560
- DRNI 125

## E

- errdisable 328
- errdisable timeout 330
- exec command mode 23

## I

- IEEE 802.1x 29
- IFNAME 18
- interface mode 23
- interface po 458
- interface sa 459
- ip radius source-interface 561
- IPv4 address
  - command syntax 18
- IPv6 address
  - command syntax 18

## L

- LACP
  - configuring 61
- LACP Commands
  - debug lacp 457
  - lacp port-priority 462
  - lacp system-priority 463
  - lacp timeout 464
  - show debugging lacp 470
  - show lacp-counter 475
  - show port etherchannel 476
  - static-channel-group 481
- LACP commands
  - port-channel load-balance 465
- lacp destination-mac 460
- lacp port-priority command 462
- lacp system-priority command 463
- lacp timeout command 464
- LINE 18
- Link aggregation 125
- LLDP commands
  - lldp system-name 584, 613
  - set lldp disable 579, 595
  - set lldp enable 580, 595
  - set lldp locally-assigned 581, 601
  - set lldp msg-tx-hold 583, 602
  - set lldp msg-tx-interval 604, 614
  - set lldp too-many-neighbors 585, 615
  - show lldp port 586, 616
- lldp system-name 584, 613

**M**

MAC address  
 command syntax 18  
 mcec domain configuration 492  
 MC-LAG 125  
 MC-LAG Configuration 125  
 mlag 493  
 MSTP  
 configuring 163

**N**

NSM Commands  
 show router-id 331

**P**

parentheses  
 command syntax 17  
 parentheses  
 command syntax 17  
 period  
 command syntax 18  
 PFC commands  
 priority-flow-control accept-peer-config 678  
 priority-flow-control link-delay-allowance 683  
 priority-flow-control mode 684  
 show priority-flow-control details 685  
 PFC priority-flow-control advertise-local-config 679  
 port 467, 469  
 portal-system-number 497  
 portal-topology 497  
 port-channel load-balance 465  
 port-channel min-links 467, 469  
 port-conv-id 497  
 privileged exec mode 23  
 Provider Bridging commands  
 bridge protocol provider-rstp 653  
 cvlan registration table 654  
 cvlan svlan 655  
 switchport customer-edge 659  
 switchport customer-edge hybrid allowed vlan 660  
 switchport customer-edge vlan registration 662  
 switchport mode customer-edge access 666  
 vlan type 672

**Q**

question mark  
 command syntax 18

**R**

radius-server host 562  
 router mode 23  
 RPVST+ commands  
 bridge protocol rpvst+ 443  
 bridge-group vlan 442

spanning-tree rpvst+ configuration 449  
 spanning-tree vlan path-cost 450  
 spanning-tree vlan restricted-role 450  
 spanning-tree vlan restricted-tcn 451

**S**

set lldp disable 595  
 set lldp enable 580, 595  
 set lldp locally-assigned 581, 601  
 set lldp msg-tx-hold 583, 602  
 set lldp msg-tx-interval 604, 614  
 set lldp too-many-neighbors 585, 615  
 show commands 20  
 exclude modifier 21  
 include modifier 21  
 redirect modifier 22  
 show debugging dot1x 565  
 show debugging lacp command 470  
 show debugging mstp 411  
 show dot1x 567  
 show errdisable details 331  
 show interface errdisable status 332  
 show interface switchport bridge 362  
 show lacp-counter command 475  
 show lldp interface 620  
 show lldp port 586, 616  
 show mac address-table count bridge 364  
 show mcec statistics 495  
 show mlag conversation-id 497  
 show mlag detail 497  
 show mlag summary 499  
 show port etherchannel command 476  
 show router-id 331  
 show running-config switch 333  
 show spanning-tree 412  
 show spanning-tree mst 416  
 show spanning-tree statistics 418  
 show vlan access-map 509  
 show vlan all 510  
 show vlan auto 512  
 show vlan brief 512  
 show vlan classifier 513  
 snmp restart mstp 421  
 spanning-tree autoedge 422  
 spanning-tree edgeport 423  
 spanning-tree guard root 424  
 spanning-tree hello-time 425  
 spanning-tree instance restricted-role 425  
 spanning-tree instance restricted-tcn 426  
 spanning-tree link-type 427  
 spanning-tree mst configuration 428  
 spanning-tree restricted-role 432  
 spanning-tree restricted-tcn 433  
 spanning-tree spvts+ configuration 449  
 spanning-tree te-msti configuration 434  
 spanning-tree vlan path-cost 450  
 spanning-tree vlan restricted-role 450  
 spanning-tree vlan restricted-tcn 451

- 
- square brackets
    - command syntax 18
  - static-channel-group 481
  - storm-control level 435
  - STP
    - configuring 217
  - STP commands
    - bridge cisco-interoperability 373
    - bridge forward-time 343
    - bridge instance priority 375
    - bridge max-age 346
    - bridge max-hops 347
    - bridge multiple-spanning-tree enable 377
    - bridge priority 348
    - bridge rapid-spanning-tree enable 382
    - bridge region 383
    - bridge revision 384
    - bridge shutdown 349
    - bridge spanning-tree enable 385
    - bridge spanning-tree errdisable-timeout enable 386
    - bridge spanning-tree portfast bpdu-filter 389
    - bridge transmit-holdcount 350
    - bridge-group path-cost 352
    - bridge-group priority 353
    - clear spanning-tree detected protocols 398
    - customer-spanning-tree customer-edge path-cost 400
    - customer-spanning-tree customer-edge priority 401
    - customer-spanning-tree forward-time 402
    - customer-spanning-tree hello-time 403
    - customer-spanning-tree max-age 404
    - customer-spanning-tree priority 405
    - customer-spanning-tree provider-edge path-cost 406
    - customer-spanning-tree provider-edge priority 407
    - customer-spanning-tree transmit-holdcount 408
    - debug mstp 409
    - show debugging mstp 411
    - show spanning-tree 412
    - show spanning-tree mst 416
    - show spanning-tree statistics 418
    - spanning-tree autoedge 422
    - spanning-tree edgeport 423
    - spanning-tree guard root 424
    - spanning-tree hello-time 425
    - spanning-tree instance restricted-role 425
    - spanning-tree instance restricted-tcn 426
    - spanning-tree link-type 427
    - spanning-tree mst configuration 428
    - spanning-tree restricted-role 432
    - spanning-tree restricted-tcn 433
  - switchport 368
    - switchport access vlan 517
    - switchport customer-edge 659
    - switchport customer-edge hybrid allowed vlan 660
    - switchport customer-edge vlan registration 662
    - switchport hybrid allowed vlan 518
    - switchport mode access 521
    - switchport mode customer-edge access 666
    - switchport mode hybrid 522, 523
    - switchport mode trunk 524
    - switchport trunk allowed vlan 525
    - switchport trunk native vlan 529
- T**
- time
    - command syntax 18
  - Topology 125
- U**
- UDLD configuration 245
- V**
- vertical bars
    - command syntax 17
  - vlan classifier ipv4 535
  - VLAN commands
    - show vlan access-map 509
    - show vlan all 510
    - show vlan auto 512
    - show vlan brief 512
    - show vlan classifier 513
    - switchport access vlan 517
    - switchport hybrid allowed vlan 518
    - switchport mode access 521
    - switchport mode hybrid 522, 523
    - switchport mode trunk 524
    - switchport trunk allowed vlan 525
    - switchport trunk native vlan 529
    - vlan classifier ipv4 535
    - vlan database 537
  - vlan database command 537
  - vlan type 672
- W**
- WORD 18